



CONTACT INFORMATION

PHONE 800.544.7521 (nationwide toll free)
847.680.3050 (local)
7:00 a.m.-6:00 p.m. Monday-Friday

FAX 800.204.2177 (24 hr. nationwide toll free)
847.680.4440 (local)

WEBSITE WWW.SHOPMEDVET.COM

EMAIL CUSTOMERSERVICE@SHOPMEDVET.COM

ADDRESS Med-Vet International
13822 West Boulton Blvd.
Mettawa, IL 60045

Dear Friends,

We would like to take this opportunity to thank you for your patronage. We appreciate all of our customers, whether they be current, past or potential customers. If you are considering a purchase from Med-Vet International, please call and speak with one of our friendly and knowledgeable customer service representatives.

Please let us know if you require a product that is not listed in our catalog. Chances are we will be able to obtain it for you at considerable savings over other companies.

At Med-Vet International, we keep our business family on a personal level to better serve your needs. From our family to yours, from our business to yours, thank you for choosing Med-Vet International.

Bill LaPietra,
President

MED-VET INTERNATIONAL

Contents

PHARMACEUTICALS

NEW Products, Specials, Brand & Generic 2-39

SUTURE AND SKIN CLOSURE

Oasis, Ethicon, Skin Staplers, Tissue Adhesive, Braunamid Cassette Suture & Ligaton Clips and Appliers **SINGLE SUTURE CLOSEOUTS!** 40-53

SYRINGES & NEEDLES 3 PAGE MONOJECT® BLOWOUT

MVI, Monoject, Excel Terumo, Ulticare, Bulb Syringes, Biopsy Needles Vaxi/Henke Drench Syringes, Henke Roux Syringe & Feeding Needles 54-70

INSTRUMENTS

Surgical Blades, Handles, Forceps, Scissors, Nail Nippers, Retractors, OB Orthopedic, Spay Packs, Instrument Packs, Spay Packs 71-109

SURGICAL AND EXAM ROOM SUPPLIES

Gowns, Masks, Instrument Wraps, Drapes, O.R. Towels Surgical Scrub Brushes, Alcohol & Thermometers 110-134

PET GROOMING AND RESTRAINTS

Underpads, Pet Carriers, Safe-T-Collars, Muzzles, Nail Nippers, Wahl® Clipper Products, Pet Rakes, Brushes, Wabbas®, Ziggles®, KONG® Balls, Rawhide Chews & Animal Leads 135-170

COTTON AND GAUZE PRODUCTS

Gauze Sponges, Cotton Roll, Cotton Balls, Lap Sponge, Stretch Gauze Rolls, Brown Gauze 171-173

GLOVES

Exam, Vinyl, Latex, Powder-Free, Nitrile, Aloe-touch®, Ansel, Surgical & Animal Handling 174-177

WOUND CARE

Cohesive Bandage, Tape (Elastic, Adhesive, Porous, Zonas & Waterproof) Adhesive Bandages and Moleskin 178-181

SCRUBS AND APPAREL

Gowns, Shoecovers, Masks, Lab Coats & **99¢ SCRUBS** (See Details) 182-197

VIALS AND CONTAINERS

Prescription Bottles, Graduated Ovals, Yorker Bottles, Sharps Containers, Specimen Containers, Cadaver Bags & Sundry Jars 198-201

I.V. ADMINISTRATION

IV Administration Sets, T-Connectors, Catheters & Infusion Sets 202-209

MONOJECT is a registered Trademark of Covidien

EQUIPMENT AND FURNISHINGS

Mayo & Instrument Trays, Stainless Steel, Aspiration Units, Animal Stretchers, Narcotic Cabinets, Gurneys, Utility Carts, Wet/Exam Tables & Cages 210-229

ORTHOPEDIC

Castling Tape, Fiberglass Tape, Cast Padding, Splints, Vet-Lite Cast, Fixation Kits, Cortical/Jorvet/Self Tapping Screws & Compression Plates 230-268

STERILIZATION

Sterilization Tubing, Autoclave Tape, Sterilization Pouches, Iodine Scrub and Solution, Air Deodorizer/Dispenser, Instrument Cleaner and Disinfectant, Ultrasonic Cleaning Solution, Instrument Brush, Disinfecting Wipes, Sterilizer and Ultrasonic cleaning unit. 269-276

DIAGNOSTIC EQUIPMENT AND SUPPLIES

Stethoscopes, Otoposcopes, Ophthalmoscopes, Microscopes, Scales Blood Flow Monitors, Pulse Oximeters, Sphygmomanometers, Refractometers & Diagnostic Tests 277-297

ANESTHESIA SUPPLIES

Mobile Anesthesia Unit, Vaporizers, Anesthesia Masks, Breathing Bags, Resuscitation Bags, Endotracheal Tubes, Laryngoscope Blades, Handles & Anesthesia Circuits 298-315

LABORATORY SUPPLIES

Centrifuges, Serum and Blood Collection Tubes, Microscope Slides, Blood Rocker & Pipettes 316-326

X-RAY SUPPLIES

Aprons, Gloves, Thyroid Cover, Illuminator & Tape 327-329

MISCELLANEOUS AND REFERENCE

Anatomical Charts, Canine & Feline Models 330-334

DENTAL

Ultrasonic Scaler/Polisher, Elevators, & Scrapers 335-346

LARGE ANIMAL

Equine and Bovine Specialty Products: Drenchers, Large Specula Semen Products, Emasculators, Hoof Care/Supplies & Catheters 347-371

INDEX/FAX ORDER PAGE

A-Z 372-384

13822 WEST BOULTON BLVD. METTAWA, IL 60045

WWW.SHOPMEDVET.COM

Phone 800-544-7521

Fax 800-204-2177

Pharmaceuticals

OPHTHALMIC & EAR CARE

Ears & Eyes

**NEO/POLY/BAC WITH
HYDROCORTISONE
OPHTHALMIC OINTMENT**

3.5gm
RXNPB-HC

\$9.95



NEO/POLY/BAC OPHTHALMIC OINTMENT

3.5gm
RXTRIPPOPH-3.5GM

\$9.99



**GENTAMICIN OPHTHALMIC
SOLUTION**

0.3%, 5ml
RXGENOPH-5

\$3.75



**TOBRAMYCIN OPHTHALMIC
SOLUTION**

5ml
RXTOBRA-5

\$4.50

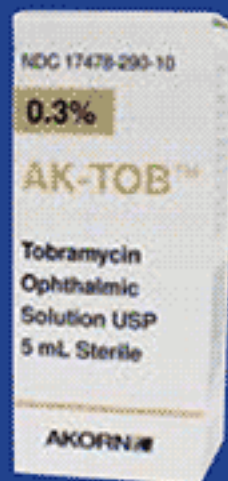

**CIPROFLOXACIN
OPHTHALMIC SOLUTION**

0.3%, 5ml
RXCIPRO-OPH5

\$2.99



BETAGEN OTIC SOLUTION
(Gentamicin, Betamethasone)

RXGEN-OTIC 7.5ml

\$3.83



TRI-OTIC OINTMENT
(Gentamicin, Betamethasone, Clotrimazole)

RXOTO-7.5 7.5gm tube \$4.49/ea
RXOTO-15 15gm tube \$6.69/ea

Starting At

\$4.49



EAR CLEANER

EAR CLEANER WITH ALOE

RXOTIC-JC 4oz bottle

\$2.45



DERMA-VET OINTMENT

(Neomycin, Nystatin, Thiostrepton, Triamcinolone)

RXDERMAVET 7.5ml \$3.50/btl
RXDERMAVET15 15ml \$5.89/btl



No returns on pharmaceuticals • Prices change frequently please call for current price • Shipping charges for refrigerated items are a flat charge based on your shipping zone. Customer accepts full responsibility for condition of products upon receipt. ❄ Indicates Refrigerated Shipping • Pictures are for graphic purposes only, actual product may be different.

13822 WEST BOULTON BLVD. METTAWA, IL 60045

WWW.SHOPMEDVET.COM

Phone 800-544-7521

Fax 800-204-2177

Priority Care® **1**

...would you settle for less?

FIRST PRIORITY®, INC.

CLINDAMYCIN ORAL DROPS

25mg/ml, 20ml

RXCLIND-20

\$3⁹⁹



TOPICAL FUNGICIDE

16 oz

RXFUNG-CIDE

\$4⁹⁹



PRICONAZOLE

1%, 2oz lotion

RXMIC-2OZ

\$2⁹⁹



1% 4oz spray

RXMIC-4OZ

\$4⁹⁹



1% 8oz spray

RXMIC-8OZ

\$7⁷⁹

LEVOXINE (LEVOTHYROXINE) POWDER

2%, 1oz

RXTHYRO-L1

\$15⁹⁹

10lb

RXTHYRO-L10

\$153⁹⁹



NOVOX (CARPROFEN) CAPLETS

Novox is a generic equivalent for Rimadyl (carprofen) caplets. Its a non-steroidal anti-inflammatory (NSAID) used to treat pain and inflammation due to arthritis and other joint diseases, including hip dysplasia. Its also used to reduce fever

25mg, 60 caplets

RXNOVOX25-60

\$20⁷⁵

100mg, 60 caplets

RXNOVOX100-60

\$31⁹⁹

25mg, 180 caplets

RXNOVOX25-180

\$56⁵⁰

100mg, 180 caplets

RXNOVOX100-180

\$87⁵⁰

75mg, 60 caplets

RXNOVOX75-60

\$25⁹⁹

75mg, 180 caplets

RXNOVOX75-180

\$62⁵⁰



No returns on pharmaceuticals • Prices change frequently please call for current price • Shipping charges for refrigerated items are a flat charge based on your shipping zone. Customer accepts full responsibility for condition of products upon receipt. ❄ Indicates Refrigerated Shipping • Pictures are for graphic purposes only, actual product may be different.

13822 WEST BOULTON BLVD. METTAWA, IL 60045

WWW.SHOPMEDVET.COM

Phone 800-544-7521

Fax 800-204-2177

0.9% BACTERIOSTATIC SODIUM CHLORIDE INJECTION

Bacteriostatic 0.9% Sodium Chloride Injection, USP is a sterile, nonpyrogenic, isotonic solution of sodium chloride in water for injection.

RX0.9NAACL-10BAC

10ml vial, Bacteriostatic

\$1.49

RX0.9NAACL-20BAC

20ml vial, Bacteriostatic

\$1.14

RX0.9NAACL-30BAC

30ml vial, Bacteriostatic

\$1.14



0.9% SODIUM CHLORIDE INJECTION

Each milliliter (mL) contains sodium chloride 9 mg and 0.9% (9 mg/mL) benzyl alcohol added as a bacteriostatic preservative.

RX0.9NAACL-10

10ml vial

93¢

RX0.9NAACL-50

50ml vial

\$2.29

RX0.9NAACL-100

100ml bag, 4 bags/pack

\$6.62

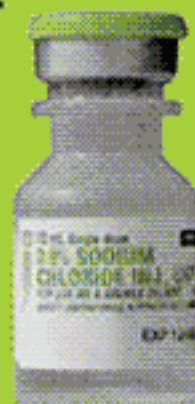

Hospira®

STERILE WATER FOR INJECTION

Sterile, nonpyrogenic preparation of water for injection which contains no bacteriostat, antimicrobial agent or added buffer and is supplied only in single-dose containers to dilute or dissolve drugs for injection.

RXWATER-10

10ml

\$0.93/btl

RXWATER-30

bacteriostatic, 30ml

\$1.07/btl

RXWATER-50

50ml

\$2.07/btl

RXWATER-100

100ml bottle

\$3.80/btl

BUPIVACAINE HCL INJECTION

RXMARCAINE-P

0.5%, 50ml

\$3.01

RXMARC-0.25

0.25%, 50ml

\$3.25



LIDOCAINE INJECTION

sterile, nonpyrogenic solution of lidocaine hydrochloride in water for injection for parenteral administration in various concentrations

RXLIDO-INJ

2%, 50ml, for nerve block

\$3.01

RXLIDO1-50

1%, 50ml, for nerve block

\$2.45



Hospira®

No returns on pharmaceuticals • Prices change frequently please call for current price • Shipping charges for refrigerated items are a flat charge based on your shipping zone. Customer accepts full responsibility for condition of products upon receipt. ❄ Indicates Refrigerated Shipping • Pictures are for graphic purposes only, actual product may be different.

13822 WEST BOULTON BLVD. METTAWA, IL 60045

WWW.SHOPMEDVET.COM

Phone 800-544-7521

Fax 800-204-2177

Pharmaceuticals

ANTIBIOTICS

AMOXICILLIN POWDER FOR SUSPENSION

RXAMS250-100 250mg/5ml, 100ml **\$3.20/btl**
 RXAMS250-150 250mg/5ml, 150ml **\$2.75/btl**



AMOXICILLIN CAPSULES

Starting At **\$19⁹⁵**

RXAMO250-500 250mg, 500 capsules **\$19.95/btl**
 RXAMO500-500 500mg, 500 capsules **\$34.00/btl**

AMOXICILLIN/CLAVULANIC ACID TABLETS

\$13⁵⁰

RXAUG875 875/125mg, 20 tablets **\$13.50**
 RXAUG500 500/125mg, 20 tablets **\$16.50**

AZITHROMYCIN

Starting At

\$8²⁵



RXZITH200-30 200mg/5ml, 30ml **\$12.79/btl**
 RXZITH-ZPAC3 250mg, 3x6 tablets/pack **\$8.25/pk**

CEFAZOLIN INJECTION

1 gram vial RXCEF1GM-V

\$1⁰⁰



CEPHALEXIN CAPSULES

RXCEP250-500 250mg, 500 capsules **\$30.95/btl**
 RXCEP500-500 500mg, 500 capsules **\$26.75/btl**



CLINDAMYCIN HCL CAPSULES

150mg, 100 capsules
 RXCLI150-100

\$7⁹⁹



METRONIDAZOLE

RXMTN250-500 250mg, 500 tablets **\$105.50/btl**
 RXMTN500-500 500mg, 500 tablets **\$210.00/btl**



CIPROFLOXACIN TABLETS

RXCIPRO-250 250mg, 100 tablets **\$12.50/btl**
 RXCIPRO-750-50 750mg, 50 tablets **\$15.50/btl**
 RXCIPRO-500 500mg, 100 tablets **\$11.59/btl**



SULFA/TRIMETHOPRIM (SMZ)

RXSMZDS-100 Double Strength, 800/160mg, 100 tablets **\$9.99/btl**
 RXSMZDS-500 Double Strength, 800/160mg, 500 tablets **\$24.00/btl**



Antibiotics

No returns on pharmaceuticals • Prices change frequently please call for current price • Shipping charges for refrigerated items are a flat charge based on your shipping zone. Customer accepts full responsibility for condition of products upon receipt. ❄ Indicates Refrigerated Shipping • Pictures are for graphic purposes only, actual product may be different.

BIOFREEZE

TUBE, 4OZ
RXBIOFREEZETUBE**\$9⁹⁹**ROLL-ON, 3OZ
RXBIOFREEZE-RO**\$7⁷⁵**

Biofreeze Pain Relieving Roll-On provides a number of unique features. The roller ball allows for product application without the need to use your hands also providing a nice massage for soft tissue wherever you apply product, and can be used in trigger point therapy.

Biofreeze Pain Relieving Gel dispensed from a tube affords the opportunity to create a more thorough experience by massaging the affected area during application. This hands-on application also reinforces touch which has been shown to be very important in the healing cycle.

Biofreeze Spray, often it's difficult for back pain sufferers and arthritic patients to get an even application of Biofreeze where they need it most. Spraying makes applying Biofreeze much easier.

Spray is colorless, uses 10% menthol and is available in a 4 fluid ounce size.

SPRAY, 4OZ
RXBIOFREEZE-SP**\$8⁷⁵**

All Biofreeze products, are paraben-free, propylene glycol free and includes a proprietary herbal blend.

Gebauer's Ethyl Chloride

A Proven Topical Anesthetic

Gebauer's Ethyl Chloride topical anesthetic skin refrigerant is intended to control the pain associated with injections, starting IV's and venipuncture, minor surgical procedures, and the temporary relief of minor sports injuries.

Gebauer's Ethyl Chloride

RXETHYL-FINE	Fine Spray, 3.5oz	\$41.50/btl
RXETHYL-CHLO	Medium Spray, 3.5oz	\$39.50/btl

**TOP
SELLER**

No returns on pharmaceuticals • Prices change frequently please call for current price • Shipping charges for refrigerated items are a flat charge based on your shipping zone. Customer accepts full responsibility for condition of products upon receipt. ❄ Indicates Refrigerated Shipping • Pictures are for graphic purposes only, actual product may be different.

13822 WEST BOULTON BLVD. METTAWA, IL 60045

WWW.SHOPMEDVET.COM

Phone 800-544-7521

Fax 800-204-2177

Vetoryl Capsules



Benefits:

- Improvement may be seen within several weeks
- Available in 10mg, 30 mg or 60 mg tablets (based on weight)

How it works:

Vetoryl contains a drug that controls the adrenal gland's excess production of cortisol, a hormone released into the bloodstream during times of stress.

VETORYL (TRILOSTANE)

RXVETORYL10	10mg, 30 capsules	\$32.45/btl
RXVETORYL30	30mg, 30 capsules	\$40.56/pk
RXVETORYL60	60mg, 30 capsules	\$52.72/pk
RXVETORYL120	120mg, 30 capsules	\$85.36/btl

Fatal Plus & DEA 222 Form

FATAL-PLUS®

Produces classic euthanasia by sequentially depressing the cerebral cortex, the lungs and the heart.

Action on target organs gives humane euthanasia of unparalleled speed, effectiveness and specificity. Instant unconsciousness is induced with simultaneous collapse of the animal.

Deep pentobarbital anesthesia ensues with blood pressure fall, stoppage of breathing and cerebral death. Cardiac function stops, quickly and irreversibly.

FATAL-PLUS SOLUTION

RXFATAL-PLUS 390mg/ml, 250ml

\$65⁵⁰/btl



Instructions for completing a: DEA 222 form to order Schedule 2 and 2n Controlled Substances

Fill in Date

Address on Form

Address on Envelope

3 ← LAST LINE COMPLETED (MUST BE 10 OR LESS)

BE SURE TO SIGN

SAMPLE

SAVE THIS WITH YOUR 222 ORDER FORMS FOR FUTURE REFERENCE

Signature required or form is invalid

* Last Line Completed: Enter only the number of lines used. In the example above, the last line completed would be 3.

Listed below is detailed information to help you in filling out the DEA form 222 for class 2 and 2n drugs. This is only to be used in ordering class 2 and 2n drugs.

- Product will be shipped to the address on the dea license only
- Form 222 can contain no corrections or strike-over marks
- Use the following Med-Vet International address on the request form: **13822 W Boulton Blvd. Mettawa, IL 60045**
- Please keep customer copy (blue copy) and mail remaining copies for processing to: **13822 W Boulton Blvd. Mettawa, IL 60045**
- Be sure to refer to the back of the blue copy of your 222 form for complete instructions



No returns on pharmaceuticals • Prices change frequently please call for current price • Shipping charges for refrigerated items are a flat charge based on your shipping zone. Customer accepts full responsibility for condition of products upon receipt. ❄ Indicates Refrigerated Shipping • Pictures are for graphic purposes only, actual product may be different.

Product	Size/Details	Product Code	Vet Label	RX	Brand	DEA
0.12% Chlorhexidine Rinse	8oz	RXCET-RINSE	✓			
0.45% Sodium Chloride for Injection	1 liter bag	RX0.45NACL-K		✓		
0.9% Bacteriostatic Sodium Chloride Injection	10ml vial, Bacteriostatic	RX0.9NACL-10BAC		✓		
	30ml vial, Bacteriostatic	RX0.9NACL-30BAC		✓		
0.9% Sodium Chloride for Irrigation	250ml bottle	RX0.9NACL-250IR		✓		
	1000ml pour bottle	RXSAL-POD1LT		✓		
0.9% Sodium Chloride Injection	10ml vial	RX0.9NACL-10		✓		
	100ml bag, 4 bags/pack	RX0.9NACL-100		✓		
	250ml bag	RX0.9NACL-250ML		✓		
	50ml vial	RX0.9NACL-50		✓		
	500ml bag	RX0.9NACL-500ML		✓		
	1000ml bag	RX0.9NACL-K		✓		
	1000ml, 12/case, Non-DEHP	RX0.9NACL-K-DE				
6% Hetastarch in Lactated Electrolyte Injection	500ml, 12/case	RXHEXTEND		✓	✓	
A & D Ointment		H-HAD13H				
Acarexx for Ear Mites	12/box	RXACAREXX	✓	✓	✓	
Accelerator	8oz	RXACCELERATOR	✓	✓	✓	
Acepromazine Tablets	10mg, 100 tablets	RXACE10-100	✓	✓		
	10mg, 500 tablets	RXACE10-500	✓	✓		
	25mg, 100 tablets	RXACE25-100	✓	✓		
	25mg, 500 tablets	RXACE25-500	✓	✓		
Acepromazine Injection	10mg/ml, 50ml	RXACE-50V	✓	✓		
Acetaminophen Childrens Liquid	160mg/5ml, 4oz	RXACETAM-LIQ				
Acetazolamide	250mg, 100 tablets	RXACETAZ-250		✓		
Acyclovir	200mg, 100 capsules	RXACY200-100		✓		
	400mg, 100 tablets	RXACY400-100		✓		
Adacel (TDAP)	10 x 0.5/ml	RXV-ADACEL-10		✓		
Adam's Flea & Tick Shampoo	gallon	RXFLTI-GAL	✓		✓	
Adam's Flea & Tick Spray	16oz	RXFLTI-MIST	✓		✓	
	32oz	RXFLTI-MIST32	✓		✓	
Adams Freedom Spot On	Large dog, 33-65lbs, 3 month	RXFREEDOM-LG	✓		✓	
	small dog, less than 33lbs, 3 month	RXFREEDOM-SM	✓		✓	
	X-large dog, greater than 65lbs, 2 month	RXFREEDOM-XL	✓		✓	
Adenocard	3mg/ml, 10 x 2ml syringes	RXADENOCARD		✓		
Adenosine Injection	3mg/ml, 2ml, 10/pk	RXADENOSINE		✓		
Adequan Canine	5ml vial, 2 per box	RXADEQ-K9	✓	✓	✓	
Adequan Equine	IM, 5ml vial	RXADEQ-EQ	✓	✓	✓	
Adriamycin Injection ❄️	200mg, 100ml	RXADR200-100		✓		
	50mg, 25ml	RXADR50-25		✓		
Advantage For Cats	orange, 1-9lbs, 4 per box	RXADV-OR-4	✓		✓	
	purple, 9-18lbs, 4 per box	RXADV-PU-4	✓		✓	
Advantage For Dogs	blue, 55-100lbs, 4 per box	RXADV-BL-4	✓		✓	
	blue, 55-100lbs, 6 per box	RXADV-BL6	✓		✓	
	green, 1-10lbs, 4 per box	RXADV-GR-4	✓		✓	
	red, 21-55lbs, 4 per box	RXADV-RE-4	✓		✓	
	teal, 11-20lbs, 4 per box	RXADV-TE-4	✓		✓	



No returns on pharmaceuticals • Prices change frequently please call for current price • Shipping charges for refrigerated items are a flat charge based on your shipping zone. Customer accepts full responsibility for condition of products upon receipt. ❄️ Indicates Refrigerated Shipping • Pictures are for graphic purposes only, actual product may be different.

Product	Size/Details	Product Code	Vet Label	RX	Brand	DEA
Advantage Multi for Dogs 	Blue, 55.1-88lbs, 6pk	RXADV-MULT-B	✓	✓		
	Green, up to 10lbs, 6pk	RXADV-MULT-G	✓	✓		
	purple, 9.1-18lbs, 6 pack	RXADV-MULT-P	✓	✓		
	red, 20.1-55lbs, 6 pack	RXADV-MULT-R	✓	✓		
	teal, 9.1-20lbs, 6 pack	RXADV-MULT-T	✓	✓		
Advantix K9	blue, over 55lbs, 6pk	RXADVANTIX-BL6	✓		✓	
	green, 0-10 bs, 6pk	RXADVANTIX-GR6	✓		✓	
	red, 21-55lbs, 6pk	RXADVANTIX-RE6	✓		✓	
	teal, 11-20lbs 6pk	RXADVANTIX-TE6	✓		✓	
AK-Con Ophthalmic Solution	0.1%, 15ml	RXAK-CON		✓		
Albon Oral Suspension	5%, 473ml	RXALBON-5	✓	✓	✓	
Albon Tablets	125mg, 200 tablets	RXALBON125-200	✓	✓	✓	
	500mg, 100 tablets	RXALBON500-100	✓	✓	✓	
Albuterol Inhalation Solution	0.5%, 20ml	RXALB-SOL-20		✓		
	0.83%, 25x3	RXALB25X3		✓		
Albuterol Sulfate	4mg, 500 tablets	RXALB4-500		✓		
Allergroom Shampoo	8oz	RXALLERGROOM8	✓		✓	
Allergy Relief Wipes	8/pack	RXWIPES-ALLERGY	✓			
Allopurinol	100mg, 100 tablets	RXALL100-100		✓		
	300mg, 100 tablets	RXALL300-100		✓		
	300mg, 500 tablets	RXALL300-500		✓		
Allu-Spray	75 gram	RXALLU-SPRAY	✓	✓		
Aloe and Oatmeal Shampoo	16oz	RXSHAMP-AO16	✓			
Alpha Trak Lancets	25 gauge, 100 per box	RXALPHA-LANCET	✓	✓	✓	
Alpha-Trak Kit	includes: blood glucose meter plus a vial of test strips, 2 bottles of control solution, a box of lancets, a quick users guide, a diabetes diary and an instructional DVD	RXALPHATRAK-KIT	✓	✓	✓	
AlphaTrak Test Strips	50/pack	RXALPHA-TRAK	✓	✓	✓	
Alprazolam (CIV)	0.25mg, 100 tablets	RXXANAX.25-100		✓		CIV
	0.5mg, 100 tablets	RXXANAX0.5-100		✓		CIV
	1mg, 100 tablets	RXXANAX1-100		✓		CIV
Alshield Aluminum Spray Bandage		RXALSHEILD	✓	✓		
Amantadine	100mg, 100 capsules	RXAMANT100-100		✓		
Amidate (Etomidate)	20mg, 10ml amp, 5/box	RXAMIDATE		✓		
Aminocaproic Acid Injection	250mg/ml, 25 x 20ml vial	RXAMICAR		✓		
Aminophylline Tablets	100mg, 1000 tablets	RXAMI100-K		✓		
	200mg, 1000 tablets	RXAMI200-K		✓		
Amiodarone HCl Injection	50mg/ml, 3ml, 10 per box	RXAMIODAR10X3		✓		
Amitriptyline	10mg, 100 tablets	RXAMIT10-100		✓		
	25mg, 100 tablets	RXAMIT25-100		✓		
	50mg, 100 tablets	RXAMIT50-100		✓		
	150mg, 100 tablets	RXAMIT150-100				
Amlodipine Besylate	10mg, 1000 tablets	RXAMLOD10-1000		✓		
	10mg, 90 tablets	RXAMLOD10-90		✓		
	2.5mg, 90 tablets	RXAMLOD2.5-90		✓		
	5mg, 90 tablets	RXAMLOD5-90		✓		
Ammonia Inhalants	0.33ml ampules, 10/pk	RXAMMONIA		✓		



No returns on pharmaceuticals • Prices change frequently please call for current price • Shipping charges for refrigerated items are a flat charge based on your shipping zone. Customer accepts full responsibility for condition of products upon receipt. ❄ Indicates Refrigerated Shipping • Pictures are for graphic purposes only, actual product may be different.

13822 WEST BOULTON BLVD. METTAWA, IL 60045

WWW.SHOPMEDVET.COM

Phone 800-544-7521

Fax 800-204-2177

Product	Size/Details	Product Code	Vet Label	RX	Brand	DEA
Amoxi-Tabs	100mg, 500 tablets	RXAMOTAB-100	✓	✓	✓	
	400mg, 250 tablets	RXAMOTAB-400	✓	✓	✓	
	50mg, 500 tablets	RXAMOTAB-50	✓	✓	✓	
Amoxicillin						
	125mg, 100 tablets	RXAMO125-100		✓		
	250mg, 100 capsules	RXAMO250-100		✓		
	250mg, 500 capsules	RXAMO250-500		✓		
	500mg, 100 capsules	RXAMO500-100		✓		
	500mg, 500 capsules	RXAMO500-500		✓		
Amoxicillin Drops	50mg/ml, 15ml	RXAMOXI-DR15	✓	✓	✓	
	50mg/ml, 30ml	RXAMOXI-DR30	✓	✓	✓	
Amoxicillin Powder for Suspension	250mg/5ml, 100ml	RXAMS250-100		✓		
	250mg/5ml, 150ml	RXAMS250-150		✓		
Amoxicillin Tablets	125mg/5ml, 100ml	RXAMS125-100		✓		
Amoxicillin/Clavulanic Acid Suspension	400/57mg/5ml, 50ml	RXAUGS400-50		✓		
	400/57mg/5ml, 75ml	RXAUGS400-75		✓		
	400/57mg/5ml, 100ml	RXAUGSUS400-100		✓		
Amoxicillin/Clavulanic Acid Tablets	200/28.5mg, 20 chewable tablets	RXAUG200		✓		
	400/57mg, 20 tablets	RXAUG400		✓		
	500/125mg, 20 tablets	RXAUG500		✓		
	875/125mg, 20 tablets	RXAUG875		✓		
Ampicillin						
	250mg, 100 capsules	RXAMP250-100		✓		
	250mg, 500 capsules	RXAMP250-500		✓		
	500mg, 100 capsules	RXAMP500-100		✓		
Ampicillin (Polyflex) Injection	500mg, 500 capsules	RXAMP500-500		✓		
	25 gram	RXAMP25GM-IN	✓	✓	✓	
Ampicillin Injection	1gm vial, 10 per box	RXAMP1GM-INJ		✓		
	500mg vial, 10 pack	RXAMP500MG-INJ		✓		
Ampicillin Suspension	250mg/5ml, 200ml	RXAMP250-200		✓		
Animax Cream	15gm	RXANIMC-15	✓	✓	✓	
	7.5gm	RXANIMC-7.5	✓	✓	✓	
Animax Ointment						
	15ml	RXANIM-15ML	✓	✓	✓	
	240ml	RXANIM-240ML	✓	✓	✓	
	30ml	RXANIM-30ML	✓	✓	✓	
Anipryl	7.5ml	RXANIM-7.5ML	✓	✓	✓	
	10mg, 30 tablets	RXANI10-30	✓	✓	✓	
	15mg, 30 tablets	RXANI15-30	✓	✓	✓	
	30mg, 30 tablets	RXANI30-30	✓	✓	✓	
Anti-Diarrhea Liquid	5mg, 30 tablets	RXANI5-30	✓	✓	✓	
	4 oz	RXDIA-4OZ	✓			
Antirobe Aquadrops	25mg/ml, 20ml	RXANTIROBE	✓	✓	✓	
Antirobe Capsules	150mg, 100 capsules	RXANTIROBE150	✓	✓	✓	
	25mg, 600 capsules	RXANTIROBE25	✓	✓	✓	
	75mg, 200 capsules	RXANTIROBE75	✓	✓	✓	
Antisedan (atipamezole) Injection	5mg/ml, 10ml	RXANTISEDAN-10	✓	✓	✓	
Anzemet Injection	500mg/25ml	RXANZEMET		✓	✓	
Arnica Ointment	3.5oz	RXARNICA				
Artificial Tear Ointment	3.5gm	RXPARALUBE-0				
Artificial Tears	15ml	RXTEARS				
Aspirin Powder	1lb	RXASPIR-POWDER	✓			
Aspirin, Baby	81mg, 36 chewable tablets	RXASPIRIN81BABY				
Aspirin, Enteric Coated	81mg, 120 tablets	RXASPIRIN81				

Product	Size/Details	Product Code	Vet Label	RX	Brand	DEA
Atenolol	25mg, 1000 tablets	RXATEN25-1000		✓		
	25mg, 100 tablets	RXATEN0L0L25		✓		
	50mg, 100 tablets	RXATEN0L0L50		✓		
Atorvastatin	20mg, 90 tablets	RXLIPITOR20-90		✓		
Atracurium	10mg/ml, 5ml, 10/pack	RXATRACURIUM		✓		
Atropine Sulfate Injection	1/120 grain, 100ml	RXATRINJ-100	✓	✓		
	15mg/ml, 100ml, large animal	RXATRINJ-LARGE	✓	✓		
Atropine Sulfate Ophthalmic Ointment	1%, 3.5gm	RXATROPINE		✓		
Atropine Sulfate Ophthalmic Solution	1%, 15ml	RXATROPH-15		✓		
	1%, 5ml	RXATROPH-5		✓		
Azathioprine	50mg, 100 tablets	RXIMURAN		✓		
Azithromycin Oral Suspension	200mg/5ml, 15ml	RXZITH200-15		✓		
	200mg/5ml, 30ml	RXZITH200-30		✓		
Azithromycin Tablets	250mg, 1x6 tablets/pack	RXZITH-ZPAC		✓		
	250mg, 3x6 tablets/pack	RXZITH-ZPAC3		✓		
	250mg, 30 tablets	RXZITH250-30		✓		
Azodyl *	90 small capsules	RXAZODYL-SC	✓	✓	✓	
Azopt Ophthalmic Solution	10ml	RXAZOPT-10ML		✓	✓	
Bacitracin Foil Packs	500u/gm, 0.03oz foil pack, 144 packs/box	RXBAC-FOILPAK		✓		
Bacitracin Ointment	500units, 1oz	RXBAC500-10Z				
Bacitracin Ointment w/Zinc	500 Units, 1 oz. Tube, Each	CUR110556H				
Baclofen	10mg, 100 tablets	RXBACLOFEN10MG		✓		
Bacto Vite Plus	10 oz. tube	RXBAC-VITE	✓		✓	
Bag Balm	10oz	RXBAG-BALM				
Banamine Injection	100ml	RXBANA-100ML	✓	✓	✓	
Banamine Paste	1500mg, 30gm	RXBANA-PASTE	✓	✓	✓	
Barium	12oz	RXBARIUM-12	✓			
Baytril Injection	22.7mg/ml, 20ml	RXBAY22.7-INJ	✓	✓	✓	
	100mg/ml, 100ml	RXBAYTRIL	✓	✓	✓	
Baytril Otic Drops	15ml	RXBAY-OTIC15	✓	✓	✓	
	30ml	RXBAY-OTIC30	✓	✓	✓	
Baytril Taste Tablets	136mg, 200 tablets	RXBAY136-200	✓	✓	✓	
	136mg, 50 tablets	RXBAY136-50	✓	✓	✓	
	22.7mg, 500 tablets	RXBAY22.7-500	✓	✓	✓	
	22.7mg, 100 tablets	RXBAY227-100	✓	✓	✓	
	68mg, 250 tablets	RXBAY68-250	✓	✓	✓	
	68mg, 50 tablets	RXBAY68-50	✓	✓	✓	
Benazepril Tablets	10mg, 100 tablets	RXBENAZ10-100		✓		
	20mg, 100 tablets	RXBENAZ20-100		✓		
	5mg, 100 tablets	RXBENAZEPRIL5MG		✓		
Bene-Bac Bird Gel	4 pack	RXBENEBAC-BIRD	✓		✓	
Bene-Bac Dog Gel	4 pack	RXBENEBAC-DOG	✓		✓	
Benzalkonium Chloride Aqueous Solution	16oz	RXBENZ-A016		✓		
Betagen (gentamicin, betamethasone) Topical Spray	60ml	RXGEN-TOP	✓	✓		
	120ml	RXGEN-TOP120	✓	✓		
	240ml	RXGEN-TOP240	✓	✓		
Betagen Otic Solution	7.5ml	RXGEN-OTIC	✓	✓		
	15ml	RXGEN-OTIC15	✓	✓		
	240ml	RXGEN-OTIC240	✓	✓		

No returns on pharmaceuticals • Prices change frequently please call for current price • Shipping charges for refrigerated items are a flat charge based on your shipping zone. Customer accepts full responsibility for condition of products upon receipt. ❄ Indicates Refrigerated Shipping • Pictures are for graphic purposes only, actual product may be different.

Product	Size/Details	Product Code	Vet Label	RX	Brand	DEA
Betamethasone Sodium Phosphate & Betamethasone Acetate Injection	6mg/ml, 5ml	RXBETA-INJ		✓		
Bethanechol Chloride Tablets	5mg, 100 tablets	RXBETHANS-100		✓		
Beuthanasia (CIII) Solution	100ml	RXBEUTH-100	✓	✓	✓	CIII
Biofreeze	Roll-On, 3oz	RXBIOFREEZE-RO		✓	✓	
	Spray, 4oz	RXBIOFREEZE-SP		✓	✓	
	Tube, 4oz	RXBIOFREEZETUBE		✓	✓	
Biotene Antiseptic Oral Gel	1oz tube, 6 tubes/pk	RXBIOGEL-6	✓		✓	
Biotin	800mcg, 110 tablets	RXBIOGIN800				
BIPS	1dose/pk, 1 large capsule	RXBIPS-LC/1	✓			
BIPS Dual Pack	2 doses/pk, 1 large and 1 small capsule	RXBIPS-DP/1	✓			
Bis-Co-Sorb	Gallon	RXBCS-G	✓			
	60ml syringe	RXBCS-PET	✓			
Bis-Co-Sorb Equine	60ml	RXBCS-EQ	✓			
Bismuth subsalicylate	gallon	RXPEPTO-BISM	✓			
Bitter Rid Spray	4 oz bottle	RXBIT-4	✓			
Bo-Se Injection	100ml	RXBO-SE	✓	✓	✓	
Brewer's Yeast	1lb	RXBREWY-1LB	✓			
Brimonidine Tartrate Ophthalmic Solution	0.2%, 15ml	RXBRIMOPH-15		✓		
Bumetanide Tablets	1mg, 100 tablets	RXBUMEX		✓		
Bupivacaine HCl Injection	0.25%, 50ml	RXMARC-0.25		✓		
	0.5%, 50ml	RXMARCAINE-P		✓		
Bupivacaine with Epinephrine Injection	0.25%, 1:200,000 50ml	RXBUPI-EPI		✓		
	0.5%, 1:200,000 50ml	RXBUPI-EPI5		✓		
Bupropion HCL	75mg, 100 tablets	RXBUPROP75-100		✓		
Buscopan Injection	20mg/ml, 50ml	RXBUSOP-50	✓	✓	✓	
Buspiron HCl	10mg, 100 tablets	RXBUSP10-100		✓		
	5mg, 100 tablets	RXBUSP5-100		✓		
Butalbital Asp/Caf (CIII)	50/325/40mg, 100 tablets	RXFIORINAL-100		✓		CIII
Butalbital Asp/Caf (CIII) with Codeine	100 capsules	RXFIORINAL-COD		✓		CIII
Calcium Antacid	150 tablets, assorted fruit flavors	RXTUMS				
Calcium Antacid EX	96 tablets, berry flavor	RXTUMS-EX				
Calcium Chloride Injection	10%, 10ml sdv	RXCAL-CHLOR		✓		
Calcium Gluconate	10%, 10ml	RXCALGLU-10		✓		
	10%, 50ml	RXCALGLU-50		✓		
Calf-Guard *	25 dose	RXCALF-GUARD	✓	✓	✓	
Capstar	blue, 2-25lbs, 6/pk	RXCAPS-BL	✓		✓	
	blue, 2-25lbs, 60 tablet bulk pack	RXCAPS-BULKB	✓		✓	
	green, over 25lbs, 60 tablet bulk pack	RXCAPS-BULKG	✓		✓	
	green, over 25lbs, 6/pk	RXCAPS-GR	✓		✓	
Captopril	12.5mg, 100 tablets	RXCAP12.5-100		✓		
	25mg, 100 tablets	RXCAP25-100		✓		
	25mg, 1000 tablets	RXCAP25-1000		✓		
	50mg, 100 tablets	RXCAP50-100		✓		
Carbocaine	2%, 50ml	RXCARBOCAINE		✓	✓	



No returns on pharmaceuticals • Prices change frequently please call for current price • Shipping charges for refrigerated items are a flat charge based on your shipping zone. Customer accepts full responsibility for condition of products upon receipt. ❄ Indicates Refrigerated Shipping • Pictures are for graphic purposes only, actual product may be different.

13822 WEST BOULTON BLVD. METTAWA, IL 60045

WWW.SHOPMEDVET.COM

Phone 800-544-7521

12

Fax 800-204-2177

Product	Size/Details	Product Code	Vet Label	RX	Brand	DEA
Carisoprodol (CIV)	350mg, 100 tablets	RXCARI350-100		✓		CIV
Cat Lax	2oz	RXCAT-LAX	✓		✓	
Catosal	100ml	RXCATOSAL-100	✓	✓	✓	
	250ml	RXCATOSAL-250	✓	✓	✓	
Cefa-Drops	50mg/ml, 15ml	RXCEFADRO-15	✓	✓	✓	
	50mg/ml, 50ml	RXCEFADRO-50	✓	✓	✓	
Cefadroxil	500mg, 100 capsules	RXCEF500-100		✓		
Cefazolin Injection	10 gram vial	RXCEF10GM-V		✓		
	1 gram vial	RXCEF1GM-V		✓		
	500mg vial	RXCEF500-V		✓		
Cefdinir	300mg, 60 capsules	RXCEFDINIR		✓		
Cefpodoxime	100mg, 100 film coated tablets	RXCEFPD100-100		✓		
	200mg, 100 film coated tablets	RXCEFPD200-100		✓		
Ceftazidime (Fortaz) Powder for Injection	1 gram	RXCEFTAZIDIME		✓		
Ceftriaxone Injection	1gram	RXROCEPHIN		✓		
	500mg	RXROCEPHIN500		✓		
Celestone Soluspan	6mg/ml, 5ml	RXCELESTONE		✓	✓	
Cephalexin	250mg, 100 capsules	RXCEP250-100		✓		
	250mg, 500 capsules	RXCEP250-500		✓		
	500mg, 100 capsules	RXCEP500-100		✓		
	500mg, 500 capsules	RXCEP500-500		✓		
Cephalexin Oral Suspension	125mg/5ml, 200ml	RXCES125-200		✓		
	250mg/5ml, 100ml	RXCES250-100		✓		
	250mg/5ml, 200ml	RXCES250-200		✓		
Cephalexin Tablets	250mg, 100 tablets	RXCEP250-100T		✓		
	500mg, 100 tablets	RXCEP500-100T		✓		
Cerenia	20 ml injection	RXCERENIA-INJ	✓	✓	✓	
	160mg, 4 tablets	RXCERENIA160	✓	✓	✓	
	16mg, 4 tablets	RXCERENIA16	✓	✓	✓	
	24mg, 4 tablets	RXCERENIA24	✓	✓	✓	
	60mg, 4 tablets	RXCERENIA60	✓	✓	✓	
Cestex	100mg, 25 tablets	RXCESTEX100-25	✓	✓	✓	
	12.5mg, 50 tablets	RXCESTEX12-50	✓	✓	✓	
	25mg, 50 tablets	RXCESTEX25-50	✓	✓	✓	
	50mg, 25 tablets	RXCESTEX50-25	✓	✓	✓	
CET Fingerbrush with Paste	1 brush, 12gm paste	RXCET-12	✓		✓	
CET Oral Hygiene Kit	1 toothbrush, 1 finger brush, toothpaste	RXCET-KIT	✓		✓	
CET Toothpaste		RXCET-PASTE	✓		✓	
Cetacaine Liquid	30gm bottle	RXCETA-LIQ		✓	✓	
Cetacaine Spray & Cannula	56gm bottle	RXCETA-SPRAY		✓	✓	
Cetirizine	10mg, 100 tablets	RXCETIRIZINE		✓		
Cetirizine Syrup	1mg/ml, 4 ounces	RXCETIRIZ-LIQ		✓		
Chlor-A Flush	4oz	RXLIDO-4	✓			
Chloraderm Shampoo	1%, 8oz	RXCHLORADERM	✓			
Chloramphenicol (Viceton)	250mg, 500 tablets	RXCHLORA250-500	✓	✓		
	500mg, 500 tablets	RXCHLORA500-500	✓	✓		
	1gm, 100 tablets	RXCHLORA1-100		✓		
Chlorhexidine and Zinc Oral Spray	8oz bottle	RXCHZN-8	✓			
Chlorhexidine Scrub/Solution	4%, 16oz	RXCHLOR4-16				
	4%, gallon	RXCHLOR4-GAL				



No returns on pharmaceuticals • Prices change frequently please call for current price • Shipping charges for refrigerated items are a flat charge based on your shipping zone.

Customer accepts full responsibility for condition of products upon receipt. ❄ Indicates Refrigerated Shipping • Pictures are for graphic purposes only, actual product may be different.



13822 WEST BOULTON BLVD. METTAWA, IL 60045

WWW.SHOPMEDVET.COM

Phone 800-544-7521

13

Fax 800-204-2177

Product	Size/Details	Product Code	Vet Label	RX	Brand	DEA
Chlorpheniramine	4mg, 100 tablets	RXCHLOM4-100				
	4mg, 1000 tablets	RXCHLOM4-1000				
Chlorpromazine Tablets	10mg, 100 tablets	RXCHL10-100		✓		
	100mg, 100 tablets	RXCHLOR100-100		✓		
Cholodin Pet Vitamins	50 tablets	RXCHOLOD-50	✓		✓	
Chondrogen EQ 	10 dose tube	RXCHON-EQ-10	✓		✓	
	50 dose powder, 25oz	RXCHON-EQ-25	✓		✓	
	150 dose powder, 75oz	RXCHON-EQ-75	✓		✓	
Chorion (HCG)	10,000 IU, 10ml	RXHCG-10	✓	✓		
Cimetidine Oral Liquid	300mg/5ml, 8oz	RXCIM300-80Z		✓		
Cimetidine Tablets	200mg, 30 tablets	RXCIM200-30		✓		
	400mg, 100tablets	RXCIM400-100		✓		
	800mg, 100 tablets	RXCIM800-100		✓		
Ciprofloxacin Ophthalmic Solution	0.3%, 2.5ml	RXCIPRO-OPH2.5		✓		
	0.3%, 5ml	RXCIPRO-OPH5		✓		
Ciprofloxacin Tablets	250mg, 100 tablets	RXCIPRO-250		✓		
	500mg, 100 tablets	RXCIPRO-500		✓		
	750mg, 50 tablets	RXCIPRO-750-50		✓		
Citalopram	20mg, 500 tablets	RXCITALOPRAM		✓		
Claforan Injection	1 gram	RXCLAF-1GM		✓	✓	
Clavamox Drops	62.5mg/ml, 15ml	RXCLAV-DR15	✓	✓	✓	
Clavamox Tablets 	125mg, 210 tablets	RXCLAV125210	✓	✓	✓	
	250mg, 210 tablets	RXCLAV250210	✓	✓	✓	
	375mg, 210 tablets	RXCLAV375-210	✓	✓	✓	
	62.5mg, 210 tablets	RXCLAV62-210	✓	✓	✓	
Clean and Fresh Oral Spray	0.1%, 8oz	RXCLEAN-8	✓			
Clemastine Tablets	1.34mg, 100 tablets	RXCLEMAST134		✓		
	2.68mg, 100 tablets	RXCLEMAST268		✓		
Clindamycin HCl Capsules	150mg, 100 capsules	RXCLI150-100		✓		
	300mg, 100 capsules	RXCLI300-100		✓		
Clindamycin Phosphate Injection	150mg/ml, 4ml, pack of 25	RXCLIND-INJ		✓		
	150mg/ml, 2ml, pack of 25	RXCLIND-INJ2		✓		
Clindamycin Phosphate Topical Solution	1%, 60ml	RXCLINTOP1-60		✓		
CliniCare Liquid Diet	8oz, canine, feline	RXCLINICARE	✓			
Clobetasol Propionate Cream	0.05%, 30gm	RXCLOB-30		✓		
Clomipramine HCl Capsules 	25mg, 90 capsules	RXCLOM25-100		✓		
	50mg, 90 capsules	RXCLOM50-100		✓		
	75mg, 90 capsules	RXCLOM75-100		✓		
Clonazepam (CIV)	0.5mg, 100 tablets	RXCLONAZ 5-100		✓		CIV
Clonidine Tablets	0.1mg, 100 tablets	RXCLONIDINE0.1		✓		
Clotrimazole Topical Solution	1%, 30ml	RXCLOT-LIQ		✓		
Clotrimazole with Betamethasone Cream	15gm	RXCLOT-BET15		✓		
Con Form Aid Granules	5 lb.	RXCONFORM5	✓		✓	
Conquer Equine	Apple Flavor, 6 Dose Tube	RXCONQ-EQ-6	✓		✓	
Conquer Equine Powder	Apple Flavor, 25oz, 50 servings	RXCONQ-EQ-25	✓		✓	

No returns on pharmaceuticals • Prices change frequently please call for current price • Shipping charges for refrigerated items are a flat charge based on your shipping zone. Customer accepts full responsibility for condition of products upon receipt. ❄ Indicates Refrigerated Shipping • Pictures are for graphic purposes only, actual product may be different.

13822 WEST BOULTON BLVD. METTAWA, IL 60045

WWW.SHOPMEDVET.COM

Phone 800-544-7521

14

Fax 800-204-2177

Product	Size/Details	Product Code	Vet Label	RX	Brand	DEA
Conquer K-9	Beef Flavor, 30 Dose Tube	RXCONQ-K9-30	✓		✓	
Contender Advance Hoof Formula	Gallon	RXCONHOO-128	✓		✓	
	32oz	RXCONHOOF-32	✓		✓	
Convenia Injection	10ml	RXCONVENIA	✓	✓	✓	
Corid (amprolium) for cattle	20% soluble powder, 10oz	RXCORID	✓	✓	✓	
Corium-20	8oz	RXCORIUM-OTIC	✓	✓	✓	
Corta RX Solution	gallon	RXCORTARX-GAL	✓	✓	✓	
Cosequin Capsules	Double Strength, 120 capsules	RXCOSDS-120	✓		✓	
Cosequin Chewable Tablets	Double Strength, 120 tablets	RXCOSDS-CHEW120	✓		✓	
	Double Strength, 250 tablets	RXCOSDS-CHEW250	✓		✓	
Cosequin Equine Powder	1400gram jar	RXCOS-EQ1400	✓		✓	
	280 gram	RXCOS-EQ280				
Cosequin For Cats	Tuna Flavor, 80 capsules/box	RXCOSFEL-80	✓		✓	
Cough for Dogs	Guafenesin/dextromethorphan 1000 tablets	RXCOUGH-TAB	✓			
Crystal Clear Calcium Gel	300ml	RXCCC-GEL	✓			
Cut-Heal Wound Spray	4oz	RXCUT-SPRAY	✓			
Cut-Pad Dog Pad Protector	4oz	RXCUT-PAD	✓			
Cyclobenzaprine Tablets	10mg, 100 tablets	RXCYCLOBENZ		✓		
Cyclopentolate Ophthalmic Solution	1%, 15ml	RXCYCLOGYL-15		✓		
Cyclophosphamide	50mg, 100 tablets	RXCYCLOPHOS50		✓		
Cyclophosphamide Injection *	500mg, 50ml	RXCYCLOPHOS-500		✓		
	100mg, 30 capsules	RXCYCLO100-30		✓		
	25mg, 30 capsules	RXCYCLO25-30		✓		
Cyclosporine (modified) Capsules	50mg, 30 capsules	RXCYCLO50-30		✓		
	100mg/ml, 50ml	RXCYCLO-SOL		✓		
Cyproheptadine	4mg, 100 tablets	RXCYP4-100		✓		
	4mg, 1000 tablets	RXCYP4-1000		✓		
Cystorelin *	5 dose, 10ml	RXCSTORELIN	✓	✓	✓	
DAP	Collar, large 70cm	RXDAP-COLL	✓			
	Collar, small 45cm	RXDAP-COLS	✓			
	Diffuser and Refill, 48ml	RXDAP-DIF	✓			
	spray, 60ml	RXDAP-SPRAY	✓			
Dasquin	for cats, 80 sprinkle caps	RXDASQUIN-CAT	✓		✓	
Dasuquin	large, 84 chew tabs	RXDASUQUIN-LG	✓		✓	
	small/medium, 84 chewable tablets	RXDASUQUIN-SM	✓		✓	
Dehydrated Alcohol	1ml ampule	RXALCOHOL		✓		
Denamarin	for Large Dogs, 425mg, 30 tablets	RXDENAMARIN-L	✓		✓	
	for medium dogs, 225mg, 30 tablets	RXDENAMARIN-M	✓		✓	
	for small dogs and cats, 90mg, 30 tablets	RXDENAMARIN-SM	✓		✓	
Denosyl Tablets	225mg, 30 tablets/box	RXDENO-225	✓		✓	
	425mg, 30 tablets/box	RXDENO-425	✓		✓	
	90mg, 30 tablets/box	RXDENO-90	✓		✓	
Dentacetic Dentees Chews	10oz pack	RXDEN-CHEW	✓		✓	
Dentacetic Dentees Stars	4oz pack	RXDEN-STARS	✓		✓	
Dentacetic Gel	2oz	RXDEN-GEL	✓		✓	
Dentacetic Wipes	25 wipes/pack	RXDEN-WIPES	✓		✓	



No returns on pharmaceuticals • Prices change frequently please call for current price • Shipping charges for refrigerated items are a flat charge based on your shipping zone.

Customer accepts full responsibility for condition of products upon receipt. ❄ Indicates Refrigerated Shipping • Pictures are for graphic purposes only, actual product may be different.

13822 WEST BOULTON BLVD. METTAWA, IL 60045

WWW.SHOPMEDVET.COM

Phone 800-544-7521

15

Fax 800-204-2177

Product	Size/Details	Product Code	Vet Label	RX	Brand	DEA
Depo Medrol	20mg/ml, 5ml	RXDEPO20-5		✓	✓	
	40mg/ml, 10ml	RXDEPO40-10		✓	✓	
	40mg/ml, 5ml	RXDEPO40-5		✓	✓	
	80mg/ml, 5ml	RXDEPO80-5		✓	✓	
Depo Medrol (Veterinary Label)	20mg/ml, 20ml	RXDEPO20-20VE	✓	✓	✓	
	40mg/ml, 5ml	RXDEPO40-5VE	✓	✓	✓	
Depoestradiol	5mg/ml, 5ml	RXDEPOESTRADIOL		✓	✓	
Deramaxx Tablets 	100mg, 30 tablets	RXDERA100-30	✓	✓	✓	
	100mg, 90 tablets	RXDERA100-90	✓	✓	✓	
	25mg, 30 tablets	RXDERA25-30	✓	✓	✓	
	25mg, 90 tablets	RXDERA25-90	✓	✓	✓	
	75mg, 30 tablets	RXDERA75-30	✓	✓	✓	
	75mg, 90 tablets	RXDERA75-90	✓	✓	✓	
Derma Cloth	7oz, 8 wipes/pk	RXDERM-CL-8	✓		✓	
Derma-Form	350gm granules	RXDERMAFORM350	✓		✓	
	8oz liquid	RXDERMAFORM8	✓		✓	
Derma-Vet Ointment	7.5ml	RXDERMAVET	✓	✓	✓	
	15ml	RXDERMAVET15	✓	✓	✓	
	240ml	RXDERMAVET240	✓	✓	✓	
	30ml	RXDERMAVET30	✓	✓	✓	
Dermabenss Shampoo	12oz	RXDERBEN-8	✓		✓	
Dermallay Oatmeal Conditioner	8oz	RXDERM-COND	✓		✓	
	gallon	RXDERM-CONDGAL	✓		✓	
Dermallay Oatmeal Shampoo	gallon	RXDERM-OSHAM-GA	✓		✓	
	12oz	RXDERM-SHAM	✓		✓	
Dermalyte Shampoo	12oz	RXDERMHY-SH	✓		✓	
DermaLyte Shampoo	gallon	RXDERMHY-G	✓	✓	✓	
Dermatonin (melatonin) Implant	12mg for dogs 25-50lbs	RXDERMATON12	✓	✓	✓	
	18mg for dogs over 50lbs	RXDERMATON18	✓	✓	✓	
	8mg for dogs under 25lbs	RXDERMATON8	✓	✓	✓	
Dermatophyte Test Medium	10 cultures/box	RXDTM-CULTURE				
Desmopressin Acetate	0.1mg, 100 tablets	RXDES.1-100		✓		
Desoximetasone Cream 	0.25%, 15gm	RXTOPICORT15		✓		
Dexamethasone Injection	10mg/ml, 10ml	RXDEX10-10		✓		
	2mg/ml, 100ml	RXDEX2-100	✓	✓		
Dexamethasone Ophthalmic Suspension	0.1%, 5ml	RXDEXOPHTH-5ML		✓		
	4mg/ml, 100ml	RXDEX4-100IN	✓	✓		
Dexamethasone S.P. Injection	4mg/ml, 30ml	RXDEX4-30		✓		
	4mg/ml, 5ml	RXDEX4-5		✓		
Dexamethasone Tablets	0.75mg, 100 tablets	RXDEX.75-100		✓		
	0.5mg, 100 tablets	RXDEX0.5-100		✓		
	4mg, 100 tablets	RXDEX4-100		✓		
Dexdomitor	0.5mg/ml, 10ml	RXDEXDOMITOR	✓	✓	✓	
Dextrose Injection	50%, 500ml bottle	RXDEX50-500		✓		
	50%, 50ml	RXDEX50-INJ		✓		
Diazepam (CIV)	10mg, 100 tablets	RXDIAZ10-100		✓		CIV
Diazepam (CIV) Injection	5mg/ml, 10ml vial, 10 pack	RXDIAZEP10X10		✓		CIV
Diazepam CIV Carpuject Injection	5mg/ml, 10 x 2ml	RXDIAZEP10X2		✓	✓	CIV
Diclofenac Sodium	75mg, 100 tablets	RXDICLOF-75		✓		
Dicural	11.4mg, 100 tablets	RXDICU11-100	✓	✓	✓	

No returns on pharmaceuticals • Prices change frequently please call for current price • Shipping charges for refrigerated items are a flat charge based on your shipping zone. Customer accepts full responsibility for condition of products upon receipt. ❄ Indicates Refrigerated Shipping • Pictures are for graphic purposes only, actual product may be different.

Product	Size/Details	Product Code	Vet Label	RX	Brand	DEA
Digoxin Tablets	0.25mg, 100 tablets	RXDIG.25-100		✓		
	0.125mg, 100 tablets	RXDIG125-100		✓		
Digoxin Elixer	0.05mg/ml, 60ml	RXDIGEL-60		✓		
Digoxin Injection	0.25mg/ml, 2ml	RXDIG-2MLINJ		✓		
Diltiazem	30mg, 500 tablets	RXDILT30-500		✓		
Diphenhydramine Capsules	25mg, 100 capsules	RXBENA25-100				
	25mg, 1000 capsules	RXBENA25-1000				
	50mg, 100 capsules	RXBENA50-100				
	50mg, 1000 capsules	RXBENA50-1000				
Diphenhydramine Cream	30gm	RXBENA-CREAM				
Diphenhydramine Elixer	12.5mg/5ml, 16 oz	RXBENA-ELIX16				
	12.5mg/5ml, 4 oz	RXBENA-ELIX4				
Diphenhydramine Injection	50mg/ml, 1ml	RXBEN-50INJ		✓		
	50mg/ml, 10ml	RXBEN50-10INJ		✓		
DL Methionine	200mg, 1000 tablets	RXDLM200-K	✓	✓	✓	
	500mg, 1000 tablets	RXDLM500-K	✓	✓	✓	
DMSO (Liquid)	1 pint	RXDMSO-PINT	✓			
DMSO Gel	1lb	RXDMSO-1LB	✓			
Dobutamine HCl	12.5mg/ml, 20ml	RXDOBUTAMINE		✓		
Docu-Soft Pet Enema	12mL	RXPET-ENEMA	✓			
Docusate Sodium (DSS)	100mg, 100 gelcaps	RXDSS100-100		✓		
	100mg, 100 Tablets	RXDSS100-100T		✓		
Dog-Odor Off	8oz spray	DO-0	✓		✓	
Dolorex (CIV) Injection	50ml	RXDOLOREX-50	✓	✓	✓	CV
Dopamine Injection	80mg/5ml, 5ml	RXDOPAMINE-V		✓		
Dormosedan	10mg/ml, 20ml	RXDORM-20	✓	✓	✓	
	10mg/ml, 5ml	RXDORM-5	✓	✓	✓	
Dorzolamide Ophthalmic	2%, 10ml	RXDORZOLAMIDE		✓		
Dorzolamide/Timolol (generic Cosopt) Ophthalmic Solution	22.3/6.8, 10ml	RXCOSOPT-10ML		✓		
Doxycycline Capsules	100mg, 500 capsules	RXDOX100-500C		✓		
	100mg, 50 capsules	RXDOX100-50C		✓		
Doxycycline Tablets	100mg, 50 tablets	RXDOX100-50T		✓		
	100mg, 500 tablets	RXDOX100-500T		✓		
Doxycycline Injection	100mg/ml, 10ml, 10 vials/pack	RXDOX-INJ		✓		
Droncit Canine	34mg, 150 tablets	RXDRONCIT34-150	✓	✓	✓	
	34mg, 50 tablets	RXDRONCIT34-50	✓	✓	✓	
Droncit Feline	23mg, 50 tablets	RXDRONCIT23-50	✓	✓	✓	
Droncit Injection	56.8mg/ml, 10ml	RXDRONCIT-INJ10	✓	✓	✓	
	Droncit Injection 56.8mg/ml, 50ml	RXDRONCIT-INJ50	✓	✓	✓	
Drontal For Cats	50 tablets	RXDRON-FEL	✓	✓	✓	
Drontal Plus	136mg, large, 30 tablets	RXDRON-K9G	✓	✓	✓	
	68mg, medium, 50 tablets	RXDRON-K9M	✓	✓	✓	
	22.7mg, small, 50 tablets	RXDRON-K9S	✓	✓	✓	
Duralactin Canine	1000mg, 60 chewable tablets	RXDURA1000-60		✓		
Durvet Bloat Treatment	12oz	RXBLOAT-12	✓			
E-SE (Vitamin E & Selenium Injection)	100ml	RXVTESELINJ	✓	✓	✓	
Ear Cleaner	4oz bottle	RXOTIC-JC	✓			
Ear Mite Killer	6oz	RXEARMITE-6	✓			

No returns on pharmaceuticals • Prices change frequently please call for current price • Shipping charges for refrigerated items are a flat charge based on your shipping zone. Customer accepts full responsibility for condition of products upon receipt. ❄ Indicates Refrigerated Shipping • Pictures are for graphic purposes only, actual product may be different.

Product	Size/Details	Product Code	Vet Label	RX	Brand	DEA
EicosaCaps Omega 3	41-70 lbs., 60 capsules	RXEICO-L	✓		✓	
	Under 40 lbs., 60 capsules	RXEICO-S	✓		✓	
Eicosaderm	EPA 360mg/DHA 240mg, 8oz	RXEICO-8	✓		✓	
Emla (2.5% lidocaine/2.5% prilocaine) Cream	lidocaine/prilocaine 2.5%/2.5%, 30gm	RXEMLA-CR		✓		
	5 gram, 5/pack	RXEMLA5X5		✓		
Enalapril Maleate Tablets	10mg, 100 tablets	RXENA10-100		✓		
	10mg, 1000 tablets	RXENA10-1000		✓		
	2.5mg, 100 tablets	RXENA2.5-100		✓		
	2.5mg, 1000 tablets	RXENA2.5-1000		✓		
	20mg, 100 tablets	RXENA20-100		✓		
	20mg, 1000 tablets	RXENA20-1000		✓		
	5mg, 100 tablets	RXENA5-100		✓		
	5mg, 1000 tablets	RXENA5-1000		✓		
	Enduracide Dip II	8oz	RXENDUDIP-8	✓		✓
1 gallon		RXENDUDIP-G	✓		✓	
Enisyl-F	100ml pump bottle	RXLYSINE-100ML	✓		✓	
EnteralCare KC Canine	Liquid Diet 11 oz, Vanilla flavor	RXKCCANINE	✓		✓	
EnteralCare KC Feline	Liquid Diet 11 oz, Vanilla flavor	RXKCFELINE	✓		✓	
Epakitin	180gm	RXEPAKITIN180	✓	✓	✓	
	300gm	RXEPAKITIN300	✓	✓	✓	
	60gm	RXEPAKITIN60	✓	✓	✓	
Ephedrine Sulfate Injection	50mg/ml, 25x1ml/pk	RXEPHED25X1		✓		
Epi-Otic Advanced Ear Cleanser	4oz	RXEPI-OTIC-A	✓		✓	
Epi-Otic Cleanser	4oz	RXEPI-OTIC	✓		✓	
	16oz	RXEPI-OTIC16	✓		✓	
	8oz	RXEPI-OTIC8	✓		✓	
Epi-Soothe	8oz.	RXEPISOOTHE-CR				
	shampoo 8oz	RXEPISOOTHE8	✓		✓	
Epi-Soothe Oatmeal Shampoo	gallon	RXEPISOOTHE-G	✓		✓	
Epinephrine HCl	1mg/ml, 30ml	RXEPI-30		✓		
	1mg/ml, 1ml ampule	RXEPI1-INJ		✓		
Epizyme Powder	12oz	RXZYME-12OZ	✓	✓	✓	
	4oz	RXZYME-4OZ	✓	✓	✓	
	8oz	RXZYME-8OZ	✓	✓	✓	
Epogen *	2000 units, 1ml	RXEPOGEN		✓		
EQ-Stim Equine Immunostimulant	5ml	RXEQSTIM-5	✓	✓	✓	
	50ml	RXEQSTIM-50	✓	✓	✓	
Equi-Aid CW	10lb	RXEQU-AID-CW	✓		✓	
Equi-Aid Psyllium	20lb	RXEQUIAID-20	✓		✓	
Equi-Mintic SPR Paste	23.6gm	RXEQUI-MINTIC	✓		✓	
Equine Bluelite	6lb	RXEQLUE-6	✓		✓	
Equine One Gel	30gm	RXEQONE-30	✓		✓	
Equioxx Paste	6gm	RXEQUIOXX	✓		✓	
Equipoise (CIII) Injection	50mg/ml, 50ml	RXEQUIPOI-50	✓	✓	✓	CIII
Eqvalan Paste	1.87%, Single Dose	RXEQVALAN	✓		✓	
Erythromycin Ophthalmic Ointment	0.5%, 3.5gm tube	RXERYOPH-3.5		✓		
Erythromycin Topical Solution	2%, 60ml	RXERYTOP2-60		✓		



No returns on pharmaceuticals • Prices change frequently please call for current price • Shipping charges for refrigerated items are a flat charge based on your shipping zone.

Customer accepts full responsibility for condition of products upon receipt. ❄ Indicates Refrigerated Shipping • Pictures are for graphic purposes only, actual product may be different.

13822 WEST BOULTON BLVD. METTAWA, IL 60045

WWW.SHOPMEDVET.COM

Phone 800-544-7521

18

Fax 800-204-2177

Product	Size/Details	Product Code	Vet Label	RX	Brand	DEA
Esbilac Puppy Milk Replacer 	12oz powder	RXESBILAC-12	✓		✓	
	11oz liquid	RXESBILAC-12.5	✓		✓	
	8oz liquid	RXESBILAC-8	✓		✓	
Esmolol Injection	1mg, 10 x 1ml/bx	RXESMOLOL	✓		✓	
Estrumate 10 dose vial	10 dose vial	RXESTRUMATE-100	✓	✓	✓	
Etodolac	300mg, 100 capsules	RXETO300-100		✓		
	400mg, 100 tablets	RXETO400-100		✓		
Euthanasia III (CIII) Solution	100ml	RXEUTH-III	✓	✓		CIII
Euthasol (CIII) Solution	100ml	RXEUTHASOL	✓	✓	✓	CIII
Excede	100mg/ml, 100ml, swine	RXEXCEDE	✓	✓	✓	
	200mg/ml, 100ml	RXEXCEDE200	✓	✓	✓	
Excenel (Ceftiofur HCl) Injection	50mg/ml, 100ml	RXEXCENEL	✓	✓	✓	
Exodus (43.9% Pyrantel) Paste	each syringe treats a 1200lb horse	RXEXODUS	✓		✓	
	Multi-dose syringe for horses (47.2g)	RXEXODUS-MD	✓		✓	
Eye Wash	4oz	RXEYE-4		✓		
Famciclovir		RXFAMCIC125-30		✓		
Famotidine Injection	10mg/ml, 20ml	RXFAMP10-20		✓		
Famotidine Tablets	10mg, 25 berry tablets	RXFAMP10-25		✓		
	20mg, 100 tablets	RXFAMP20-100		✓		
	20mg, 1000 tablets	RXFAMP20-1000		✓		
	40mg, 100 tablets	RXFAMP40-100		✓		
Fatal-Plus Solution (CII)	390mg/ml, 250ml	RXFATAL-PLUS	✓	✓	✓	CII
Fecal Floatation Medium	Zinc Sulfate, gallon	RXOVA-ZNGAL				
Feliway 	diffuser and refill, 48ml	RXFELIWAY-DIF	✓		✓	
	Refill, 48ml	RXFELIWAY-REF	✓		✓	
	spray, 75ml	RXFELIWAY-SP	✓		✓	
Felovite II	2.5oz	RXFELOVITE	✓			
Fentanyl (CII) Transdermal Patch	100mcg/hr, 5/box	RXFENTANYL100		✓		CII
	12mcg/hr, 5/box	RXFENTANYL12.5		✓		CII
	25mcg/hr, 5/box	RXFENTANYL25		✓		CII
	50mcg/hr, 5/box	RXFENTANYL50		✓		CII
	75mcg/hr, 5/box	RXFENTANYL75		✓		CII
Fentanyl Citrate Injection (CII)	0.05mg/ml, 50ml vial, 25 vials/pack	RXFENTANY-INJ50		✓		CII
	0.05mg/ml, 5ml vial, 25 vials/pack	RXFENTANYL-INJ		✓		CII
Flea and Tick Collar	22 inch	RXFLTI-COLR	✓			
Flourescein Stain Strips	100/box	RXFUL-GLO				
Fluconazole	100mg, 100 tablets	RXFLU100-100		✓		
	200mg, 100 tablets	RXFLU200-100		✓		
	200mg, 30 tablets	RXFLU200-30		✓		
Fludrocortisone Acetate 	0.1mg, 100 tablets	RXFLORINEF		✓		
Flunixin Meglumine	50mg/ml, 100ml	RXFLUNIX-100	✓	✓		
	50mg/ml, 250ml	RXFLUNIX-250	✓	✓		
Fluocinonide Cream	0.05%, 60gm	RXFLUOC-C60G		✓		
Fluocinonide Ointment	0.05% 60 gram	RXFLUOC-60G		✓		
Fluocinonide Solution	0.05%, 60ml	RXFLUOC-60ML		✓		
Fluoxetine Capsules	10mg, 100 capsules	RXFLUOX10-100		✓		
	10mg, 30 tablets	RXFLUOX10-30		✓		
	20mg, 100 capsules	RXFLUOX20-100		✓		
Fluoxetine HCl Oral Solution	20mg/5ml, 120ml	RXFLUOX-LIQ		✓		

No returns on pharmaceuticals • Prices change frequently please call for current price • Shipping charges for refrigerated items are a flat charge based on your shipping zone. Customer accepts full responsibility for condition of products upon receipt. ❄ Indicates Refrigerated Shipping • Pictures are for graphic purposes only, actual product may be different.

Product	Size/Details	Product Code	Vet Label	RX	Brand	DEA
Flurazepam (CIV)	15mg, 100 tablets	RXFLURAZEPAM		✓		CIV
Flurbiprofen Sodium Ophthalmic Solution	0.03%, 2.5ml	RXFLURB-OPH		✓		
Fly Rid Plus	1 gallon	RXFLY-RIDPLUS	✓			
Folic Acid	800mcg, 100 tablets	RXFOLIC-800		✓		
Forbid	12/pack	RXFORBID-12	✓		✓	
Four Paws Medicated Anti-Itch Spray	8oz	AP-F01736	✓		✓	
Free Magic Coat Flea and Tick Shampoo	16oz	F-AP-F10620	✓		✓	
Frontline Plus 	89-132 lbs, 3 month	RXFRON-132-3	✓		✓	
	89-132 lbs, 6 month	RXFRON-132-6	✓		✓	
	up to 22 lbs, 3 month	RXFRON-22-3	✓		✓	
	up to 22 lbs, 6 month	RXFRON-22-6	✓		✓	
	23-44 lbs, 3 month	RXFRON-44-3	✓		✓	
	23-44 lbs, 6 month	RXFRON-44-6	✓		✓	
	45-88 lbs, 3 month	RXFRON-88-3	✓		✓	
	45-88 lbs, 6 month	RXFRON-88-6	✓		✓	
	Feline, 3 month	RXFRON-FEL-3	✓		✓	
	Feline, 6 month	RXFRON-FEL-6	✓		✓	
Furosemide Injection	10mg/ml, 2ml SDV	RXFUR10-2ML		✓		
	10mg/ml, 25 x 2ml SDV	RXFUR10-2X25		✓		
	50mg/ml, 50ml	RXFUR50-50	✓	✓		
Furosemide Oral Solution 	10mg/ml, 120ml	RXFUR-120ML		✓		
	10mg/ml, 60ml	RXFUR-60ML		✓		
Furosemide Tablets 	40mg, 1000 tablets	RXFUR40-K		✓		
	20mg, 100 tablets	RXFUR020-100		✓		
	20mg, 1000 tablets	RXFUR020-K		✓		
	40mg, 100 tablets	RXFUR040-100		✓		
	12.5mg, 500 tablets	RXLAS12.5-500	✓	✓	✓	
	50mg, 500 tablets	RXLAS50-500	✓	✓	✓	
Gabapentin Capsules 	100mg, 100 capsules	RXGABA100-100		✓		
	300mg, 100 capsules	RXGABA300-100		✓		
	400mg, 100 capsules	RXGABA400-100		✓		
	800mg, 100 capsules	RXGABA800-100		✓		
Gastrogard 	14 syringe pack	RXGASTRO-14	✓	✓	✓	
Gebauer's Ethyl Chloride 	Medium Spray, 3.5oz glass bottle	RXETHYL-CHLO		✓	✓	
	Fine Spray, 3.5oz glass bottle	RXETHYL-FINE		✓	✓	
Gemfibrozil	600mg, 500tablets	RXGEMFIBROZIL		✓		
Genesis Spray	16oz	RXGENESIS16OZ	✓	✓	✓	
Gentamicin Injection	100mg/ml, 100ml	RXGEN100-INJ	✓	✓		
	100mg/ml, 250ml	RXGEN250-INJ	✓	✓		
Gentamicin Ointment	0.1%, 15gm	RXGENOI-15		✓		
Gentamicin Ophthalmic Ointment	3.5gm	RXGENOPH-VET		✓		
Gentamicin Ophthalmic Solution	0.3%, 5ml	RXGENOPH-5		✓		
Gentamicin Sulfate Cream	0.1%, 15gm	RXGENCR-15GM		✓		
	0.1%, 30gm	RXGENCR-30		✓		
Geri-Form Chewable	150 tablets	RXGERIFORM150	✓			
Ginkgo Biloba	100mg, 100 capsules	RXGINK-100	✓			
	50mg, 90 capsules	RXGINK-50	✓			
Glimepiride	4mg, 500 tablets	RXGLIM4-500		✓		

No returns on pharmaceuticals • Prices change frequently please call for current price • Shipping charges for refrigerated items are a flat charge based on your shipping zone. Customer accepts full responsibility for condition of products upon receipt. ❄ Indicates Refrigerated Shipping • Pictures are for graphic purposes only, actual product may be different.

Pharmaceuticals

GLIMEPIRIDE - HyCOAT

Product	Size/Details	Product Code	Vet Label	RX	Brand	DEA
Glipizide	10mg, 100 tablets	RXGLIP10-100		✓		
	5mg, 100 tablets	RXGLIP5-100		✓		
Glucosamine Chewable Treats	240 ct tub	RXGLUCOS-CH240	✓		✓	
Glyco-Flex Classic	300mg, 250 tablets	RXGF300-250	✓		✓	
	300mg, 500 tablets	RXGF300-500	✓		✓	
	600mg, 120 tablets	RXGF600-120	✓		✓	
Glyco-Flex I	Cats, 45 tablets	RXGFC-45	✓		✓	
	120 soft chews	RXGFI-120	✓		✓	
	90 tablets	RXGFI-90	✓		✓	
Glyco-Flex II	120 soft chews	RXGFII-120	✓		✓	
	90 tablets	RXGFII-90	✓		✓	
	Cats, 45 tablets	RXGFIIIC-45	✓		✓	
	Equine, 120 pellets	RXGFIIIEQ-120	✓		✓	
Glyco-Flex III	120 soft chews	RXGFIII-120	✓		✓	
	90 tablets	RXGFIII-90	✓		✓	
Glycopyrrolate	0.2mg/ml, 20ml	RXGLY20-INJ		✓		
	0.2mg/ml, 5ml	RXGLY5-INJ		✓		
GoLytely Powder for Solution	4000ml, 6/cs, regular flavor	RXGOLYTELY		✓		
Goodwinol Ointment	1oz	RXDEMODEC-1	✓		✓	
Granulex Spray	4oz, 12/case	RXGRANULEX	✓	✓	✓	
Greenies	Jumbo Size, 4/pack	RXGRJ-4	✓		✓	
	Large Size, 8/pack	RXGRL-8	✓		✓	
	Petite Size, 24/pack	RXGRP-24	✓		✓	
	Regular Size, 12/pack	RXGRR-14	✓		✓	
Griseofulvin	125mg, 100 tablets	RXGRI125-100		✓	✓	
	250mg, 100 tablets	RXGRI250-100		✓	✓	
Griseofulvin Oral Suspension	125mg/5ml, 4 ounce	RXGRI-4OZ		✓		
HCTZ (Hydrochlorothiazide)	12.5mg, 100 tablets	RXHCTZ12.5-100		✓		
	25mg, 100 tablets	RXHCTZ25-100		✓		
	25mg, 1000 tablets	RXHCTZ25-1000		✓		
Heartgard Feline	5-15lbs, 6 month/card	RXHGP-F	✓	✓	✓	
Heartgard Plus Chewables	Small, 0-25lbs, Blue, 6 month/card	RXHGP-S	✓	✓	✓	
	Small, 0-25lbs, Blue, 12 month/card	RXHGP-S-12	✓	✓	✓	
	Medium, 26-50lbs, Green, 6 month/card	RXHGP-M	✓	✓	✓	
	Medium, 26-50lbs, Green, 12 month/card	RXHGP-M-12	✓	✓	✓	
	Large, 51-100lbs, Brown, 6 month/card	RXHGP-L	✓	✓	✓	
	Large, 51-100lbs, Brown, 12 month/card	RXHGP-L-12	✓	✓	✓	
Hemostatic Solution	15ml	RXHEMOSTAT-15		✓		
Heparin	1000 units/ml, 30ml	RXHEPARIN		✓		
Hetastarch 6% in 0.9% NaCl Injection	500ml, 12/case	RXHETASTARCH		✓		
Hi-Vite Drops	1oz	RXHI-VITE	✓		✓	
Humulin-NPH Insulin	U-100, 10ml	RXHUMULIN-NPH			✓	
Humulin-R Insulin	U-100, 10ml	RXHUMULIN-R			✓	
Hyaflex For Dogs	Oral Hyaluronic Acid, 1oz	RXHAFLEX	✓		✓	
Hyalovet	2ml syringe	RXHVALOV-2SY	✓	✓	✓	
	2ml vial	RXHVALOV-2V	✓	✓	✓	
Hyalun For Horses	Oral Hyaluronic Acid, 1oz	RXHVALUN	✓		✓	
HyCoat	50mg, 10ml	RXHYCOAT	✓	✓		

No returns on pharmaceuticals • Prices change frequently please call for current price • Shipping charges for refrigerated items are a flat charge based on your shipping zone. Customer accepts full responsibility for condition of products upon receipt. ❄ Indicates Refrigerated Shipping • Pictures are for graphic purposes only, actual product may be different.

Product	Size/Details	Product Code	Vet Label	RX	Brand	DEA
Hydrocodone/APAP (CIII)	10/650mg, 500 tablets	RXHYDROCODONE10		✓		CIII
	10/325mg, 500 tablets	RXNORCO-500		✓		CIII
	5/500mg, 100 tablets	RXVICODIN-100		✓		CIII
	5/500mg, 500 tablets	RXVICODIN-500		✓		CIII
Hydrocodone/Homatropine (CIII) Syrup	5-1.5mg/5ml, 16oz	RXHYCODAN16OZ		✓		CIII
Hydrocodone/Ibuprofen (CIII)	7.5/200mg, 100 tablets	RXVICOPROFEN		✓		CIII
Hydrocortisone Cream	1%, 30gm	RXCORT-CRM				
	2.5%, 30 gram	RXCORT2.5-30		✓		
Hydrocortisone Cream 1% Crm 1.5g Packet 48/Box	48 Packets/Box	CUR015408Z		✓		
Hydrocortisone Ointment	1%, 30gm	RXCORT-OINT				
Hydrocortisone Tablets	20mg, 100 tablets	RXCORT20-100TAB		✓		
Hydrogen Peroxide	16oz	HYD-P				
Hydroquinone Cream	4%, 30gm	RXHYDROQ-30		✓		
Hydroxyzine HCL Tablets	10mg, 100 tablets	RXHYDROHCL10		✓		
	10mg, 500 tablets	RXHYDROHCL10D		✓		
	25mg, 100 tablets	RXHYDROHCL25		✓		
	25mg, 500 tablets	RXHYDROHCL25D		✓		
	50mg, 100 tablets	RXHYDROHCL50		✓		
	50mg, 500 tablets	RXHYDROHCL50D		✓		
Hydroxyzine HCl Injection	50mg/ml, 10ml	RXHYDROHCL50INJ		✓		
Hydroxyzine Pamoate Capsules	25mg, 100 capsules	RXHYDR25-100		✓		
	25mg, 500 capsules	RXHYDR25-500		✓		
	50mg, 100 capsules	RXHYDR50-100		✓		
	50mg, 500 capsules	RXHYDR50-500		✓		
	100mg, 100 capsules	RXHYDR100-100		✓		
Hylartin V *	2ml	RXHILARTIN-V	✓	✓	✓	
Hytril Injection	6ml	RXHYUINJ-6	✓	✓	✓	
I-Drop Vet	Box of 20 Single Use Allets	RXEYEDROP-20	✓		✓	
I-Drop Vet Plus	Box of 20 Single Use Allets	RXEYEDROP-PLUS	✓		✓	
I-Lid `n Lash Hygiene Vet	45gm tube	RXEYELID	✓		✓	
I-pen Vet	each	RXIPEN	✓	✓	✓	
Ibuprofen Tablets	600mg, 500 tablets	RXIBU600-500		✓		
	800mg, 500 tablets	RXIBU800-500		✓		
Ichthammol Ointment	14oz	RXICHTHAMMOL	✓			
Idexx Serum Cups	250 cups/bag	RXIDEXXSERCUPS	✓		✓	
Idexx Snap Test *	FelV Ag/FIV Ab Combo, 15 tests/box	RXCOMBO-15D	✓		✓	
	FelV Ag/FIV Ab Combo, 30 tests/box	RXCOMBO-30D	✓		✓	
	FELV Antigen Test, 15 tests/box	RXFELV-15D	✓		✓	
	FELV Antigen Test, 30 tests/box	RXFELV-30D	✓		✓	
	Giardia, 15 tests/box	RXGIAR-15D	✓		✓	
	Heartworm Antigen, 15 tests/box	RXHEART-15D	✓		✓	
	Heartworm Antigen, 30 tests/box	RXHEART-30D	✓		✓	
	Canine Pancreatitis, 10/box	RXIDEXX-PANC	✓		✓	
	feline triple (FelV/FIV/Heartworm) 15 tests/box	RXIDEXX-TRIPLE	✓		✓	
	4DX for heartworm, ehrlichia, lyme and anaplasmosis, 30 tests/box	RXIDEXX4DX-30	✓		✓	
	CPL, 10 tests/kit	RXIDEXXCPL	✓		✓	
	Parvo Antigen, 5 tests/box	RXPARVO-5D	✓		✓	



Product	Size/Details	Product Code	Vet Label	RX	Brand	DEA	
Idexx Test *	3DX for heartworm, ehrlichia, lyme, 30 tests/box	RXIDEXX-3DX-30	✓		✓		
	Alkaline Phosphatase 25 tests/box	RXIDEXXALP	✓		✓		
	ALT 25 tests/box	RXIDEXXALT	✓		✓		
	Amylase 25 tests/box	RXIDEXXAMYL	✓		✓		
	BUN 25 tests/box	RXIDEXXBUN	✓		✓		
	CBC5R (LaserCyte) 50 tests/box	RXIDEXXCBC	✓		✓		
	Creatinine 25 tests/box	RXIDEXXCRE	✓		✓		
	General Health Profile (GHP), 12 chem/ profile, 2 profiles/box	RXIDEXXGHP	✓		✓		
	Glucose slides, 25 tests/box	RXIDEXXGLU	✓		✓		
	Lipase 25 tests/box	RXIDEXXLIP	✓		✓		
	Pre-Anesthetic Profile (PAP), 6 chem/panel, 4 panels/box	RXIDEXXPAP	✓		✓		
	T4 15 tests/box	RXIDEXXT4	✓		✓		
Idexx Vet Test Metering Tips	500/box	RXIDEXX-TIPS	✓		✓		
Imipramine	50mg, 100 tablets	RXIMIPRAMINE50		✓			
Imizol	10ml	RXIMIZOL		✓			
Immiticide	5vials/box	RXIMMIT-5	✓	✓	✓		
Indomethacin Sustained Release	75mg, 60 capsules	RXINDOMETH75-60		✓			
Interceptor Tablets		Brown, 2-10lbs, 12 month/pk	RXINT-BR-12	✓	✓	✓	
		Brown, 2-10lbs, 6 month/pk	RXINT-BR-6	✓	✓	✓	
		Green, 11-25lbs, 12 month/pk	RXINT-GR-12	✓	✓	✓	
		Green, 11-25lbs, 6 month/pk	RXINT-GR-6	✓	✓	✓	
		White, 51-100lbs, 12 month/pk	RXINT-WH-12	✓	✓	✓	
		White, 51-100lbs, 6 month/pk	RXINT-WH-6	✓	✓	✓	
		Yellow, 26-50lbs, 12 month/pk	RXINT-YE-12	✓	✓	✓	
		Yellow, 26-50lbs, 6 month/pk	RXINT-YE-6	✓	✓	✓	
Intervet Cattle Dosing Device Kit	Cattle Dosing Device Kit	RXDOSE-GUN					
Intralipid	20%, 100ml	RXINTRALIPID	✓	✓	✓		
Iron Dextran	100mg, 100ml	RXIRON-100	✓	✓			
	100ml	RXISO-100	✓	✓			
Isoflurane Inhalant Anesthetic	250ml	RXISO-250	✓	✓			
	10mg, 100 tablets	RXISOSORB10-100		✓			
Isoxsuprine	20mg, 1000 tablets	RXISOX20-1000	✓	✓			
Itraconazole	100mg, 28 capsules	RXITRA100-28		✓			
Iverhart Max Chewable	Toy, 6-12lbs, 6 tablets/pack	RXIVER-MAXT6	✓	✓	✓		
	Small, 12.1-25lbs, 6 tablets/pack	RXIVER-MAXS6	✓	✓	✓		
	Medium, 25.1-50lbs, 6 tablets/pack	RXIVER-MAXM6	✓	✓	✓		
	Large, 50.1-100lbs, 6 tablets/pack	RXIVER-MAXL6	✓	✓	✓		
	large, 51-100lbs, 6 tablets/pk	RXIVER-LG	✓	✓	✓		
Iverhart Plus		medium, 26-50lbs, 6 tablets/pk		✓	✓	✓	
			RXIVER-MED		✓	✓	✓
		small, up to 25lbs, 6 tablets/pk	RXIVER-SM	✓	✓	✓	
Ivermectin Injection	1%, 50ml	RXIVOMEC	✓				
Ivermectin Paste	1.87%, 6.08gm	RXIVER-PAST	✓				
Ivomec Drench for Sheep	960ml	RXIVO-SHEEP	✓		✓		
Ivomec Injection for Cattle and Swine	1%, 200ml	RXIVO1-200	✓		✓		
	1%, 50ml	RXIVOMEC-50	✓		✓		

No returns on pharmaceuticals • Prices change frequently please call for current price • Shipping charges for refrigerated items are a flat charge based on your shipping zone. Customer accepts full responsibility for condition of products upon receipt. ❄ Indicates Refrigerated Shipping • Pictures are for graphic purposes only, actual product may be different.

Product	Size/Details	Product Code	Vet Label	RX	Brand	DEA
KBro-Vet (Potassium Bromide)	250mg, 60ct	RXKBROVET250	✓	✓	✓	
	500mg, 60ct	RXKBROVET500	✓	✓	✓	
Kenalog Injection	10mg/ml, 5ml	RXKENA10-5		✓	✓	
	40mg/ml, 1ml	RXKENA40-1		✓	✓	
	40mg/ml, 10ml	RXKENA40-10		✓	✓	
	40mg/ml, 5ml	RXKENA40-5		✓	✓	
Kennel Dip II	16oz	RXKENDIP-16	✓		✓	
	4oz	RXKENDIP-4	✓		✓	
KeraTex Hoof Hardener	250ml	RXKERATEX				
Ketamine (CIII) Injection	100mg/ml, 10ml	RXKETAMINE	✓	✓		CIII
Ketochlor Shampoo	16oz	RXKETOCHLOR	✓		✓	
Ketoconazole Cream	2%, 30g, Cream	RXKCN-30		✓		
Ketoconazole Tablets	200mg, 100 tablets	RXKCN200-100		✓		
Ketofen Injection	100mg/ml, 100ml	RXKETO-100	✓	✓	✓	
	100mg/ml, 50ml	RXKETO-50	✓	✓	✓	
Ketoprofen Capsules	50mg, 100 capsules	RXKETO50-100		✓		
Ketorolac SDV	60mg, 2ml	RXKETOROLAC		✓		
KMR Kitten Milk Replacer	11oz liquid	RXKMR-11OZ	✓		✓	
	12oz powder	RXKMR-12	✓		✓	
	6oz powder	RXKMR-6	✓		✓	
	8oz liquid	RXKMR-8OZ	✓		✓	
L-Asparaginase *	10,000 IU, 10ml	RXELSPAR-10		✓		
Lactated Ringers IV Solution	1000ml	RXRINGL-1000		✓		
	250ml	RXRINGL-250		✓		
	500ml	RXRINGL-500		✓		
Lactated Ringers with 5% Dextrose IV Solution	1000ml	RXRINGL-DEX		✓		
Lactoquil	90 chewable tablets	RXLACTOQUIL	✓	✓	✓	
Lactulose Solution	10g/15ml, 16oz	RXLAC-16		✓		
	10g/15ml, 32oz	RXLAC-32		✓		
Lantus Insulin *	U100, 10ml	RXLANTUS		✓	✓	
Latanoprost Ophthalmic Solution	0.005%, 2.5ml	RXLATANOPROST		✓		
Latisse	0.3%, 3ml	RXLATISSE		✓	✓	
Laxatone (Regular Flavor)	2.5oz	RXLAX-2.5OZ	✓		✓	
	4.25oz	RXLAX-4.5OZ	✓		✓	
Leflunomide	10mg, 30 tablets	RXLEFLUN10-30				
	20mg, 30 tablets	RXLEFLUNOMIDE		✓		
Legend Injection	10mg/ml, 4ml	RXLEGEND-4ML	✓	✓	✓	
Leukeran Tablets *	2mg, 50 tablets	RXLEUKERAN		✓		
Leuprolide Ace	1mg/0.2ml, 2.8ml, 14 day kit	RXLUPRON		✓		
Levofloxacin tablets	500mg, 50 tablets	RXLEVOFLOX500		✓		
Levothyroxine	0.1mg, 100 tablets	RXLEVO.1-100		✓		
	0.1mg, 1000 tablets	RXLEVO.1-1000		✓		
	0.112mg, 100 tablets	RXLEVO.112-100		✓		
	0.112mg, 1000 tablets	RXLEVO.112-1000		✓		
	0.125mg, 1000 tablets	RXLEVO125-1000		✓		
	150mcg, 100 tablets	RXLEVO150-100		✓		
	0.15mg, 1000 tablets	RXLEVO150-1000		✓		
	200mcg, 100 tablets	RXLEVO200-100		✓		
	0.05mg, 100 tablets	RXLEVO50MCG		✓		

No returns on pharmaceuticals • Prices change frequently please call for current price • Shipping charges for refrigerated items are a flat charge based on your shipping zone. Customer accepts full responsibility for condition of products upon receipt. ❄ Indicates Refrigerated Shipping • Pictures are for graphic purposes only, actual product may be different.

Product	Size/Details	Product Code	Vet Label	RX	Brand	DEA
Levothyroxine Veterinary Chews	0.1mg, 1000 ct	RXLEV-CH1-1000	✓	✓		
	0.1mg, 180 ct	RXLEV-CH1-180	✓	✓		
	0.2mg, 1000ct	RXLEV-CH2-1000	✓	✓		
	0.2mg, 180ct	RXLEV-CH2-180	✓	✓		
	0.3mg, 1000ct	RXLEV-CH3-1000	✓	✓		
	0.3mg, 180ct	RXLEV-CH3-180	✓	✓		
	0.4mg, 1000 ct	RXLEV-CH4-1000	✓	✓		
	0.4mg, 180 ct	RXLEV-CH4-180	✓	✓		
	0.5mg, 1000 ct	RXLEV-CH5-1000	✓	✓		
	0.5mg, 180 ct	RXLEV-CH5-180	✓	✓		
	0.6mg, 1000 ct	RXLEV-CH6-1000	✓	✓		
	0.6mg, 180 ct	RXLEV-CH6-180	✓	✓		
	0.7mg, 1000 ct	RXLEV-CH7-1000	✓	✓		
	0.7mg, 180 ct	RXLEV-CH7-180	✓	✓		
	0.8mg, 1000 ct	RXLEV-CH8-1000	✓	✓		
	0.8mg, 180 ct	RXLEV-CH8-180	✓	✓		
Lidocaine Injection (preservative-free)	1%, 30ml, pack of 25	RXLIDO-PF30		✓		
Lidocaine 5% Ointment	35.44gm tube	RXLIDO-35		✓		
	5%, 50gm	RXLIDO-50		✓		
Lidocaine Injection	2%, 50ml, for nerve block	RXLIDO-INJ		✓		
	1%, 50ml, for nerve block	RXLIDO1-50		✓		
Lidocaine with Epinephrine	2%, 30ml	RXLIDO-EPI		✓		
	1%, 50ml	RXLIDO1-50EPI		✓		
	1%, 30ml	RXLIDO1-EPI		✓		
Lime Plus Dip	16oz	RXLYMDYP-16	✓	✓	✓	
	1 gallon	RXLYMDIP-GAL	✓	✓	✓	
Lincocin Aqua Drops	50mg/ml, 20ml	RXLIN-AQUA	✓	✓	✓	
Lincocin Injection	100mg/ml, 20ml	RXLIN100-20	✓	✓	✓	
	300mg/ml, 10ml	RXLIN300-10	✓	✓	✓	
Lincocin Tablets	200mg, 250 tablets	RXLIN200-250	✓	✓	✓	
Lipo-Form Chewable	50 tablets	RXLIPOFORM50	✓			
	500 tablets	RXLIPOFORM500	✓			
Lisinopril	10mg, 100 tablets	RXLISINOP10-100		✓		
	20mg, 100 tablets	RXLISINOP20-100		✓		
	40mg, 100 tablets	RXLISINOP40-100		✓		
	5mg, 100 tablets	RXLISINOP5-100		✓		
	5mg, 1000 tablets	RXLISINOP5-1000		✓		
	2.5mg, 100 tablets	RXLISINOPRIL2.5		✓		
Lisinopril with HCTZ Tablets	20/12.5mg, 100 tablets	RXLISIN/HCTZ		✓		
Liver-7 Injection *	100ml	RXLIVER-7	✓	✓	✓	
Lixotinic	1 gallon	RXLIX-1GAL	✓		✓	
Loratadine	10mg, 30 tablets	RXLORATADINE				
Lorazepam (CIV)	1mg, 100 tablets	RXLORAZEPAM1MG		✓		CIV
	2mg, 100 tablets	RXLORAZEPAM2MG		✓		CIV
Lorazepam (CIV) Injection	2mg/ml, 10 x 1ml	RXLORAZ10X1		✓		CIV
Losartan (generic Cozaar)	25mg, 100 tablets	RXCOZAAR25-100		✓		
	50mg, 90 tablets	RXCOZAAR50-90		✓		
Lovenox	300mg/3ml, 10/box	RXLOVENOX		✓	✓	

No returns on pharmaceuticals • Prices change frequently please call for current price • Shipping charges for refrigerated items are a flat charge based on your shipping zone. Customer accepts full responsibility for condition of products upon receipt. ❄ Indicates Refrigerated Shipping • Pictures are for graphic purposes only, actual product may be different.

13822 WEST BOULTON BLVD. METTAWA, IL 60045

WWW.SHOPMEDVET.COM

Phone 800-544-7521

25

Fax 800-204-2177

Product	Size/Details	Product Code	Vet Label	RX	Brand	DEA
Loxicam (meloxicam) Injection		RXLOXICAM	✓	✓		
Lumicaine Topical Solution	250mg, 60ml	RXLUMICAINE		✓	✓	
Lutalyse	30ml	RXLUTY-30	✓	✓	✓	
Lysodren Tablets	500mg, 100 tablets	RXLYS500-100		✓		
Magna Gel	10 oz. tube	RXMAG-GEL	✓			
Mal-A-Ket Shampoo	8oz.	RXMAL-KET8	✓		✓	
Malacetic Conditioner	8oz	RXMAL-CON8	✓		✓	
Malacetic Otic	16oz	RXMALOTIC-16	✓		✓	
	4oz	RXMALOTIC-4	✓		✓	
Malacetic Shampoo	Gallon	RXMAL-SHAMG	✓		✓	
	12oz	RXMAL-SHM12	✓		✓	
	16oz	RXMAL-SHM16	✓		✓	
Malacetic Ultra Shampoo	8oz	RXMAL-SHM8	✓		✓	
Malacetic Wet Wipes	5" x 9" Wipes, 25/pack	RXMAL-WIPE	✓		✓	
	6" X 7" wipes, 100/pack	RXMAL-WIPE100	✓		✓	
Mannitol Injection	20%, 100ml, VETERINARY LABEL	RXMANI-100	✓	✓		
Marcaine Injection	0.25%, 50ml	RXMARCAINE25-50		✓	✓	
	0.5%, 50ml	RXMARCAINE50		✓	✓	
Marcaine Preservative-Free	0.5%, 10ml, 10/box	RXMARCAINE10		✓	✓	
Marquis Paste	127g syringe	RXMARQUIS	✓	✓	✓	
MASS (Multi-Active Strengthening System)	32oz	RXMASS-32	✓		✓	
Meclizine	12.5mg, 100 tablets	RXMECLIZINE		✓		
Medrol Tablets	4mg, 500 tablets	RXMEDROL4MG	✓	✓	✓	
Medroxyprogesterone (Generic Depo-Provera)	150mg/ml, 1ml	RXDEPO-P150-1		✓		
Megestrol Acetate	20mg, 100 tablets	RXMEGACETATE		✓		
Meloxicam	7.5mg, 100 tablets	RXMELOX7.5-100		✓		
	15mg, 100 tablets	RXMELOX15-100		✓		
	15mg, 1000 tablets	RXMELOX15-1000		✓		
Metacam Injection	5mg/ml, 10ml	RXMETA-INJ	✓	✓	✓	
Metacam Oral Suspension	0.5mg/ml, 15ml	RXMETA0.5-15	✓	✓	✓	
	1.5mg/ml, 10ml	RXMETA-10	✓	✓	✓	
	1.5mg/ml, 32ml	RXMETA-32	✓	✓	✓	
	1.5mg/ml, 100ml	RXMETA-100	✓	✓	✓	
Metformin ER	500mg, 100 tablets	RXMETFOR-ER500		✓		
Metformin HCl	1000mg, 100 tablets	RXMETFORMIN		✓		
Methazolamide	25mg, 100 tablets	RXMETHAZOL25		✓		
	50mg, 100 tablets	RXMETHAZOL50		✓		
Methergine Table	0.2mg, 100 tablets	RXMETHERGINE		✓		
Methigel	4.25 oz	RXMETHIGEL	✓	✓	✓	
Methimazole Tablets	10mg, 100 tablets	RXMETHI10-100		✓		
	5mg, 100 tablets	RXMETHI5-100		✓		
Methocarbamol Tablets	500mg, 100 tablets	RXMET500-100		✓		
	500mg, 500 tablets	RXMET500-500		✓		
	750mg, 500 tablets	RXMET750-500		✓		
Methocarbamol (Robaxin) Injection	100mg/ml, 10ml	RXMETHO-INJ		✓		
Methylprednisolone	4mg, 100 tablets	RXMPRED4-100		✓		
Methylprednisolone Injection	40mg/ml, 5ml	RXMPRED40-5		✓		



No returns on pharmaceuticals • Prices change frequently please call for current price • Shipping charges for refrigerated items are a flat charge based on your shipping zone.

Customer accepts full responsibility for condition of products upon receipt. ❄️ Indicates Refrigerated Shipping • Pictures are for graphic purposes only, actual product may be different.

13822 WEST BOULTON BLVD. METTAWA, IL 60045

WWW.SHOPMEDVET.COM

26

Phone 800-544-7521

Fax 800-204-2177

Product	Size/Details	Product Code	Vet Label	RX	Brand	DEA
Metoclopramide HCl	10mg, 100 tablets	RXMTCL10-100		✓		
	10mg, 500 tablets	RXMTCL10-500		✓		
	5mg, 100 tablets	RXMTCL5-100		✓		
Metoclopramide Injection	5mg/ml, 2ml	RXMTCL-INJ2		✓		
Metoclopramide Oral Liquid	5mg/5ml, 16oz	RXMTCL-LIQ		✓		
Metoprolol ER	50mg, 100 tablets	RXMETOP50-100		✓		
Metoprolol Tartrate	100mg, 100 tablets	RXMETOP100-100		✓		
	25mg, 100 tablets	RXMETOP25-100		✓		
Metronidazole Injection	500mg, 100ml, 4/pack	RXMTN-INJ		✓		
Metronidazole Tablets	250mg, 250 tablets	RXMTN250-250		✓		
	250mg, 500 tablets	RXMTN250-500		✓		
	500mg, 100 tablets	RXMTN500-100		✓		
	500mg, 500 tablets	RXMTN500-500		✓		
Mexiletine	200mg, 100 capsules	RXMEXL200-100		✓		
Miconazole Nitrate Cream	2%, 1oz	RXMIC-1OZ				
Miconosol Lotion/Spray	1%, 120ml	RXMICONAZ-SP	✓	✓		
	1%, 60ml	RXMICONAZ-SP60	✓	✓		
Midazolam (CIV) Injection	5mg/ml, 10ml, 10 vials/pack	RXMIDAZ-10X10		✓		CIV
Milk Of Magnesia, 1/Pint		MM-P				
Minocycline	100mg, 50 capsules	RXMINOCY100-50		✓		
	100mg, 500 capsules	RXMINOCY100-500		✓		
Minoxidil	10mg, 100 tablets	RXMINOX10-100		✓		
	10mg, 500 tablets	RXMINOX10-500		✓		
Miracle Sand Out Pellets	5lb	RXSAND-OUT	✓		✓	
Mirtazapine Tablets	15mg, 30 tablets	RXMIRTAZ15-30		✓		
	30mg, 30 tablets	RXMIRTAZ30-30		✓		
Missing Link Plus Joint Support Professional Strength Formula	canine, 1lb	RXMISS-LINK-PL	✓		✓	
Mitaban (Amitraz) Dip	10.6ml	RXMITABAN	✓	✓	✓	
Mometamax	7.5gm	RXMOMETAMAX	✓	✓	✓	
	15gm	RXMOMETAMAX15	✓	✓	✓	
Morphine (CII) Sulfate Injection	15mg/ml, 20ml	RXMORPHINE		✓		CII
MSM	1lb	RXMSM-1LB	✓			
Mupirocin (generic Bactroban) Ointment	2%, 22gm	RXBACTROBAN		✓		
Mycophenolate Mofetil	250mg, 100 capsules	RXMYCOPHEN250		✓		
Nalbuphine HCl Injection	10mg/ml, 10ml, 25/pack	RXNALB-24		✓		
Naloxone HCl Injection	0.4mg/ml, 1ml vial, 10/pack	RXNALOXONE		✓		
Naproxen	500mg, 100 tablets	RXNAPRO500-100		✓		
	500mg, 500 tablets	RXNAPRO500-500		✓		
Naproxen Delayed Release EC	500mg, 100 tablets	RXNAPRO-EC		✓		
Nasalgen IP Vaccine ^{MSD}	10 dose tank	RXNASALGEN	✓	✓	✓	
	10 x 1 dose	RXNASALGEN-IP	✓	✓	✓	
Naxcel Sterile Powder	1gm	RXNAX-1	✓	✓	✓	
	4gm	RXNAX-4	✓	✓	✓	
Neo-predef Topical Powder	15 gram	RXNEOPREDEF	✓	✓	✓	
Neo/Poly/Bac Ophthalmic Ointment	3.5gm	RXTRIPOPH-3.5GM		✓		
Neo/Poly/Bac with Hydrocortisone Ophthalmic Ointment	3.5gm	RXNPB-HC		✓		



No returns on pharmaceuticals • Prices change frequently please call for current price • Shipping charges for refrigerated items are a flat charge based on your shipping zone.

Customer accepts full responsibility for condition of products upon receipt.  Indicates Refrigerated Shipping • Pictures are for graphic purposes only, actual product may be different.

13822 WEST BOULTON BLVD. METTAWA, IL 60045

WWW.SHOPMEDVET.COM

Phone 800-544-7521

Fax 800-204-2177

Product	Size/Details	Product Code	Vet Label	RX	Brand	DEA
Neo/Poly/Dex Ophthalmic Ointment	3.5gm	RXMAXOPH-3.5		✓		
Neo/Poly/Dex Ophthalmic Suspension	5ml	RXMAXOPH-5		✓		
Neomycin, Polymixin B, Hydrocortisone Otic Solution	10ml	RXNPHOTIC-10		✓		
Neomycin, Polymixin, Gramicidin Ophthalmic Solution	10ml	RXNEO-GRAM		✓		
NFZ Wound Powder	45grams	RXNITRO-45	✓	✓		
Niacinamide	500mg, 110 tablets	RXNIA500-100		✓		
Nitrofurantoin Mono/Macro (Generic Macrobid)	100mg, 100 capsules	RXMACROBID		✓		
Nitrofurazone Dressing	1lb	RXNITRO-DRES	✓			
Nolvasan Otic	4oz	RXNOLV-OTIC4	✓		✓	
Nolvasan S Cleaner	1 pint	RXNOLS-16	✓		✓	
Normosol-R IV Fluids	1000ml	RXNORMOSOL-R	✓	✓	✓	
Novox (Carprofen) Caplets	100mg, 180 caplets	RXNOVOX100-180	✓	✓		
	100mg, 60 caplets	RXNOVOX100-60	✓	✓		
	25mg, 180 caplets	RXNOVOX25-180	✓	✓		
	25mg, 60 caplets	RXNOVOX25-60	✓	✓		
	75mg, 180 caplets	RXNOVOX75-180	✓	✓		
	75mg, 60 caplets	RXNOVOX75-60	✓	✓		
Nuflor (Florfenicol) Injection	100ml	RXNUFLOR	✓	✓	✓	
NurseMate Foal	1 dose tube	RXNURSEFOA-1	✓			
Nursing Bottle Kit	2oz bottle, cap, 2 nipples and brush	RXNURTURALL-BOT	✓			
Nurturall C Puppies	8oz liquid	RXNURTURALL-P8	✓		✓	
Nutrical Vitamin Gel	4.25oz tube	RXNUMI-4.25	✓		✓	
Nystatin Cream	30gm	RXNYS-PLAIN		✓		
Nystatin with Triamcinolone Ointment	30gm	RXNYS-30		✓		
O.F.A. Plus Garlic	up to 30lbs, 60 capsules	RXOFAGAR-30	✓			
	50-70lbs, 60 capsules	RXOFAGAR-50	✓			
Oasis Vet Shield	box of 6	RXCORNEA		✓		
Ofloxacin Ophthalmic Solution	0.3%, 5ml	RXOFLOXACIN-OPH		✓		
Ofloxacin Otic Solution	0.3%, 5ml	RXOFLOX-OTIC		✓		
Omega 3 Gel Caps	Large Dog, 60 gelcaps	RXOMELD-60	✓			
	Small Dog, 60 gelcaps	RXOMESD-60	✓			
Omeprazole	20mg, 30 capsules	RXOMEPRAZOLE		✓		
Ondansetron	4mg, 30 tablets	RXZOF4-30		✓		
Ondansetron for Injection	2mg/ml, 5x2ml	RXZOF-INJ		✓		
	2mg/ml, 20ml	RXZOF-INJ20		✓		
Ondansetron ODT	4mg, 30 tablets	RXZOF-ODT		✓		
Opti-Vet Eye Drops	0.5 oz	RXHY-OPTIC	✓		✓	
Optimmune Ophthalmic Ointment	1/8oz tube	RXOPTI-1/8OZ	✓	✓	✓	
Optyse	each	RXOPTYSE	✓	✓	✓	
Oral Amino Acid Concentrate	500ml	RXAMINO-500	✓	✓		
Orbax (Orbifloxacin)	22.7mg, 250 tablets	RXORBAX-22.7	✓	✓	✓	
	5.7mg, 250 tablets	RXORBAX-5.7	✓	✓	✓	
	68mg, 100 tablets	RXORBAX68-100	✓	✓	✓	



No returns on pharmaceuticals • Prices change frequently please call for current price • Shipping charges for refrigerated items are a flat charge based on your shipping zone.

Customer accepts full responsibility for condition of products upon receipt. ❄ Indicates Refrigerated Shipping • Pictures are for graphic purposes only, actual product may be different.

13822 WEST BOULTON BLVD. METTAWA, IL 60045

WWW.SHOPMEDVET.COM





Phone 800-544-7521

28

Fax 800-204-2177

Pharmaceuticals

Osteochon Joint Care - Phenylbutazone Tablets

Product	Size/Details	Product Code	Vet Label	RX	Brand	DEA
Osteochon Joint Care 	6 yearling/12 foal paste	RXOSTEO-PAST	✓		✓	
	2.5lb powder	RXOSTEO-POW	✓		✓	
Osteoform	500 tablets	RXOSTEOFORM	✓	✓		
Oticare A Ear Cleaner	4oz	RXOTIC66704	✓			
Oticare P Ear Powder	6 gram	RXOTIC66606	✓			
Otisothe II Ear Cleaner	16oz	RXOTIC66716	✓			
Otomax	8oz bottle	RXOTOM-8	✓	✓	✓	
	7.5gm	RXOTOMAX7.5	✓	✓	✓	
	15gm	RXOTOMAX15	✓	✓	✓	
	6 x 30ml/pack	RXOTOMAX30	✓	✓		
Outlast Spray	32oz	RXOUTLAST32	✓		✓	
Ovassay Plus	Kit with Solution	RXOVASSAY-KIT	✓		✓	
Oxytocin	100ml	RXOXY-100	✓	✓		
Pad Tough Spray	4oz	RXPAD-TOUGH	✓			
Panacur C Canine Dewormer	1gm packet (10lbs), 30 packets/box	RXPANACUR-C10	✓		✓	
	2gm packet (20lbs), 30 packets/box	RXPANACUR-C20	✓		✓	
	4gm packet (40lbs), 30 packets/box	RXPANACUR-C40	✓		✓	
Panacur Granules	1lb	RXPANACUR-LB	✓	✓	✓	
Panacur Paste 	25gm	RXPANA-PASTE	✓	✓	✓	
Panacur Powerpac	5 pack	RXPANACUR-5	✓	✓	✓	
Panacur Suspension 	10%, 1 gallon	RXPANACUR-GA	✓	✓	✓	
	10%, 1000ml	RXPANACUR-LT	✓	✓	✓	
Panakare Plus Tablets	100 tablets	RXPANA-TAB	✓	✓	✓	
Pancrezyme	8oz	RXPANCREAZYME	✓	✓	✓	
Papaverine Injection	30mg/ml, 10ml	RXPAPAVERINE		✓		
Parvosan Disinfectant	gallon	RXPARVOSAN	✓			
Paylean (Ractopamine)	9gm/lb, 25lb bag	RXPAYLEAN	✓	✓	✓	
Penicillin (long acting) Injection *	100ml	RXPENLA-100	✓			
	250ml	RXPENLA-250	✓			
Penicillin Injection * 	100ml	RXPEN-100	✓			
	250ml	RXPEN-250	✓			
	500ml	RXPEN-500	✓			
	500mg, 500 tablets	RXPENVK-500		✓		
Penicillin VK	250mg, 100 tablets	RXPENVK250-100		✓		
	250mg, 1000 tablets	RXPENVK250-1000		✓		
	500mg, 100 tablets	RXPENVK500-100		✓		
Pentoxifylline	400mg, 100 tablets	RXPENTOX400		✓		
Percorten-V Injection	25mg/ml, 4ml	RXPERCORTEN	✓	✓	✓	
Pet-form Chewable	50 tablets	RXPETFORM-50	✓		✓	
	150 tablets	RXPETFORM150	✓		✓	
	500 tablets	RXPETFORM500	✓		✓	
Petchek Heartworm PF Antigen Test	192 tests/box	RXPETCHEK-D	✓		✓	
Phenol EZ Swabs	30 swabs/pack	RXPHENOL-EZ		✓	✓	
Phenteramine (CIV)		RXPENTER37.5		✓		
Phenylbutazone Injection *	20%, 100ml	RXBUT-INJ	✓	✓		
Phenylbutazone Paste	12gm	RXBUT-PASTE	✓	✓		
Phenylbutazone Tablets	1gm, 100 tablets	RXBUT1GM-100	✓	✓		

No returns on pharmaceuticals • Prices change frequently please call for current price • Shipping charges for refrigerated items are a flat charge based on your shipping zone. Customer accepts full responsibility for condition of products upon receipt. ❄ Indicates Refrigerated Shipping • Pictures are for graphic purposes only, actual product may be different.

Product	Size/Details	Product Code	Vet Label	RX	Brand	DEA
Phenylephrine HCl Ophthalmic Solution *	10%, 5ml	RXPHENYLEPH-10				
	2.5%, 5ml	RXPHENYLEPH-OPH		✓		
Pilocarpine HCl Ophthalmic Solution	2%, 15ml	RXPIL2-15		✓		
	4%, 15ml	RXPIL4-15		✓		
Piroxicam Capsules	10mg, 100 capsules	RXPIR010-100		✓		
	20mg, 100 capsules	RXPIR020-100		✓		
Pirsue Mastitis Tubes	12 Tubes/pk	RXPIRSUE-12	✓	✓	✓	
Polyglycan Injection	10ml	RXPOLYGLYCAN	✓	✓		
Polymixin B Sulf and Trim Ophthalmic Solution	10ml	RXTRIM-10		✓		
Polymixin B Sulfate and Bacitracin Zinc Antibiotic Ophthalmic Ointment	3.5gm	RXPOLYBAC-OPH				
Potassium Chloride Injection	20meq, 10ml	RXPOT-CHL		✓		
	40meq/ml, 20ml, 25/pack	RXPOT-CHL25X40		✓		
Potassium Citrate	640mg, 100 tablets	RXPOT-CIT	✓	✓		
	100 tablets	RXPOT-CITC100		✓		
	10meq, 100 tablets	RXUROCIT-K		✓		
		RXPOT-CITCG	✓	✓		
Potassium Citrate Cranberry Granules			✓	✓		
Potassium Gluconate	200mg, 120 tablets	RXPOT-GLU	✓	✓		
PPD (Purified Protein Derivative) Test *	10 test vial	RXPPD-10		✓		
Prednisolone Acetate Ophthalmic Suspension	1%, 10ml	RXPDOPH-10		✓		
	1%, 15ml	RXPDOPH-15		✓		
	1%, 5ml	RXPDOPH-5		✓		
Prednisolone Syrup	15mg/5ml, 16 oz	RXPREDNIS16OZ		✓		
Prednisone Tablets	10mg, 100 tablets	RXPRED10-100		✓		
	10mg, 1000 tablets	RXPRED10-1000		✓		
	20mg, 100 tablets	RXPRED20-100		✓		
	20mg, 1000 tablets	RXPRED20-K		✓		
	5mg, 100 tablets	RXPRED5-100		✓		
	5mg, 1000 tablets	RXPRED5-K		✓		
					✓	
Prednisone Oral Solution	5mg/5ml, 120ml	RXPRED1-120		✓		
Primidone Tablets	250mg, 100 tablets	RXPRIMIDONE250		✓		
Primor	1200mg, 100 tablets	RXPRIMOR1200	✓	✓	✓	
	240mg, 500 tablets	RXPRIMOR240	✓	✓	✓	
	600mg, 100 tablets	RXPRIMOR600	✓	✓	✓	
Priority Care 1% Furosemide Syrup	2 oz	RXFUR-20Z-PC	✓	✓		
Priority Care 3% Hydrogen Peroxide	gallon	HYD-G-PC	✓			
	16oz	HYD-P-PC	✓			
Priority Care Bismusol	gallon	RXBISMUSOL	✓			
Priority Care Clindamycin Oral Drops	25mg/ml, 20ml	RXCLIND-20	✓	✓		
Priority Care Corti-Derm Spray	1 oz	RXCORTI-DERM1	✓			
Priority Care Feca-Med, Sodium Nitrate Fecal Floatation Medium	Gallon	RXOVA-GAL	✓			
Priority Care General Lube	gallon with pump	RXLUBE-GAL	✓			
Priority Care Hydrocortisone 1% Shampoo with Oatmeal	8oz	RXCORT-SHAM	✓			



No returns on pharmaceuticals • Prices change frequently please call for current price • Shipping charges for refrigerated items are a flat charge based on your shipping zone.

Customer accepts full responsibility for condition of products upon receipt. ❄ Indicates Refrigerated Shipping • Pictures are for graphic purposes only, actual product may be different.

13822 WEST BOULTON BLVD. METTAWA, IL 60045

WWW.SHOPMEDVET.COM

30

Phone 800-544-7521

Fax 800-204-2177

Pharmaceuticals

HYDROCORTISONE 1% SPRAY WITH OATMEAL - PROMETHAZINE PLAIN

Product	Size/Details	Product Code	Vet Label	RX	Brand	DEA
Priority Care Hydrocortisone 1% Spray with Oatmeal	4 oz. spray	RXCORT-SPRAY				
Priority Care Kaolin Pectin	gallon	RXKAOPEC-GAL	✓			
Priority Care Levoxine (levothyroxine) Powder	1lb	RXTHYRO-L1	✓	✓		
	10lb	RXTHYRO-L10	✓	✓		
Priority Care Magna-Poultice	20oz	RXPOUL-20OZ	✓			
Priority Care Mineral Oil, 95 Viscosity	gallon	RXMIN-95	✓			
Priority Care Non-Spermicidal Lube Jelly	5oz	RXLUBE-STER	✓			
Priority Care Povidone Iodine Scrub	gallon	PVPSCR-G-PC	✓			
Priority Care Povidone Iodine Solution	gallon	PVPSOL-G-PC	✓			
Priority Care Pributazone Boluses	100 tablets	RXBUT-BOLUS	✓	✓		
Priority Care Priconazole	1%, 2oz lotion	RXMIC-2OZ	✓	✓		
	1% 4oz spray	RXMIC-4OZ	✓	✓		
	1% 8oz spray	RXMIC-8OZ	✓	✓		
Priority Care Propylene Glycol USP	Gallon	RXPROGLYCOL	✓			
Priority Care Scarlet Oil	16oz	RXSCAR-DRE4	✓			
Priority Care Topical Fungicide	16 oz	RXFUNG-CIDE	✓			
Priority Care Triodine 7	16oz with sprayer	RXTRIODINE7-16	✓	✓		
	32oz	RXTRIODINE7-32	✓	✓		
Pro-Zinc Insulin *	for Cats, 40 units/ml, 10ml	RXPRO-ZINC	✓	✓		
ProAir HFA Albuterol Inhaler	90mcg	RXPROAIR		✓		
Probiotic Gel for Small Animals	15gm	RXPROBIOTIC-15	✓			
Prochlorperazine Injection	5mg/ml, 2ml x 10 vials/pack	RXCOMPAZINE-INJ		✓		
	5mg/ml, 2ml	RXCOMPAZINE2ML		✓		
Profender for Cats	Large, 11.1-17.6lbs, 1.12ml, 24/box	RXPROFEND-LG	✓	✓	✓	
	Medium, 5.6-11lbs, 0.7ml, 40/box	RXPROFEND-M	✓	✓	✓	
	Small, 2.2-5.5lbs, 0.35ml, 40/box	RXPROFEND-SM	✓	✓	✓	
Progesterone in Oil	50mg/ml, 10ml	RXPROGE50-10		✓		
Program Flavor for Cats	Yellow, 7-15lbs, 6 tablets/pack	RXPROGFEL15-6TA	✓		✓	
	Green, 0-6lbs, 6 tablets/pack	RXPROGFEL6-6TAB	✓		✓	
Program Flavor for Dogs	Green (11-20lbs), 6 tablets/box	RXPROG-GREEN	✓		✓	
	White (46-90lbs), 6 tablets/box	RXPROG-WHITE	✓		✓	
	Yellow (21-45lbs), 6 tablets/box	RXPROG-YELLOW	✓		✓	
Program Suspension for Cats	0-10lbs, 6/pack	RXPROGFEL10-6	✓		✓	
	11-20lbs, 6/pack	RXPROGFEL20-6	✓		✓	
Proin (Phenylpropanolamine) Plain	50mg, 180 chewable tablets	RXPROIN50-180	✓	✓	✓	REQ
Proin (Phenylpropanolamine) Tablets	25mg, 60 chewable tablets	RXPROIN25-60	✓	✓	✓	REQ
	50mg, 60 chewable tablets	RXPROIN50-60	✓	✓	✓	REQ
	75mg, 60 chewable tablets	RXPROIN75-60	✓	✓	✓	REQ
Promethazine Injection	25mg/ml, 1ml vial, 25/pack	RXPROMETH-INJ2		✓		
Promethazine	25mg, 12/pack	RXPROMETH-SUP				
	25mg, 100 tablets	RXPROMETHAZINE		✓		
Promethazine Plain	6.25mg/5ml, 16oz	RXPROMETH16OZ		✓		



No returns on pharmaceuticals • Prices change frequently please call for current price • Shipping charges for refrigerated items are a flat charge based on your shipping zone. Customer accepts full responsibility for condition of products upon receipt. ❄ Indicates Refrigerated Shipping • Pictures are for graphic purposes only, actual product may be different.

Pharmaceuticals

PROPALIN CHEW TABLETS - RIFAMPIN

Product	Size/Details	Product Code	Vet Label	RX	Brand	DEA
Propalin Chew Tablets 	25mg, 60 chewable tablets	RXPROP25-60	✓	✓	✓	REQ
	50mg, 180 chewable tablets	RXPROP50-180	✓	✓	✓	REQ
	50mg, 60 chewable tablets	RXPROP50-60	✓	✓	✓	REQ
	75mg, 60 chewable tablets	RXPROP75-60	✓	✓	✓	REQ
Proparacaine HCL Ophthalmic Suspension *	0.5%, 15ml	RXPROOPH-15		✓		
Propofol 	10mg/ml, 20ml	RXPROPOFOL		✓		
	1%, 50ml, pack of 20	RXPROPOFOL-50		✓		
Propranolol 	20mg, 100 tablets	RXPROP20-100		✓		
	40mg, 100 tablets	RXPROP40-100		✓		
	40mg, 1000 tablets	RXPROP40-1000		✓		
Propranolol Injection	1mg, 10 x 1ml/bx	RXPROPRAN-INJ		✓		
Provable for Dogs and Cats	80 capsules	RXPROVABLE-CAP	✓		✓	
Puppy Paste	13 gram syringe	RXWORM-PASTE	✓			
Puralube Brand Ophthalmic Ointment	3.5 gram	RXPURALUBE-VET	✓		✓	
Pyoben Shampoo	8oz	RXPYOBEN-8	✓		✓	
Pyrantel Pamoate Suspension	32oz	RXPYRANTEL	✓			
	1 gallon	RXPYRANTEL-GAL	✓			
Pyridostigmine Bromide	60mg, 100 tablets	RXPYRID60-100		✓		
Quartermaster Tube	10ml, 12/pack	RXQUARTER	✓	✓	✓	
Quest	11.3gm	RXQUEST-11.3	✓		✓	
Quinapril 	10mg, 90 tablets	RXACCUPRIL10-90		✓		
	20mg, 90 tablets	RXACCUPRIL20-90		✓		
Ranitidine 	150mg, 100 tablets	RXZAN150-100		✓		
	300mg, 100 tablets	RXZAN300-100		✓		
	300mg, 250 tablets	RXZAN300-250		✓		
Regu-mate	dispensing gun	RXREGU-DISPGUN	✓			
	1000ml	RXREGUMATE-K	✓	✓	✓	
Renakare (Potassium Gluconate)	2meq, 100 tablets	RXRENA2-100	✓	✓	✓	
Renakare Gel	5oz	RXRENAKARE-GEL	✓	✓	✓	
Renal K+ Gel	5oz	RXRENAL-K	✓	✓	✓	
Resi-Chlor Lotion	8 oz	RXRESI-CHLOR	✓	✓	✓	
Resi-Cort Leave on Lotion	8 oz	RXRESI-CORT	✓	✓	✓	
Respiram (Doxapram) Injection	20mg/ml, 20ml	RXRESPIRAM	✓	✓	✓	
Revalor S	Box of 10x10 cartridge implants	RXREVALOR-S	✓		✓	
Revolution for Cats	Blue, 5-15lbs, 6 months/box	RXREV-BLU	✓	✓	✓	
	Blue, 5-15lbs, 3 months/box	RXREV-BLU3	✓	✓	✓	
Revolution for Dogs 	Brown, 10-20lbs, 6 months/box	RXREV-BROW	✓	✓	✓	
	Brown, 10-20lbs, 3 months/pack	RXREV-BROW3	✓	✓	✓	
	Plum, 85-130lbs, 3 months/box	RXREV-PLUM	✓	✓	✓	
	Purple, 5-10lbs, 6 months/box	RXREV-PUR	✓	✓	✓	
	Purple, 5-10lbs, 3 month/pack	RXREV-PUR3	✓	✓	✓	
	Red, 20-40lbs, 6 months/box	RXREV-RED	✓	✓	✓	
	Teal, 40-85lbs, 6 months/box	RXREV-TEAL	✓	✓	✓	
	Revolution for Puppies and Kittens	Mauve, up to 5lbs, 3 months/box	RXREV-MAUVE3	✓	✓	✓
Rifampin	150mg, 30 capsules	RXRIFAMPIN150		✓		

No returns on pharmaceuticals • Prices change frequently please call for current price • Shipping charges for refrigerated items are a flat charge based on your shipping zone. Customer accepts full responsibility for condition of products upon receipt. ❄ Indicates Refrigerated Shipping • Pictures are for graphic purposes only, actual product may be different.

13822 WEST BOULTON BLVD. METTAWA, IL 60045

WWW.SHOPMEDVET.COM

Phone 800-544-7521

32

Fax 800-204-2177

Product	Size/Details	Product Code	Vet Label	RX	Brand	DEA
Rimadyl Caplets	100mg, 60 caplets	RXRIM100-60CAP	✓	✓	✓	
	75mg, 60 caplets	RXRIM75-60CAP	✓	✓	✓	
Rimadyl Chew Tablets	100mg, 180 chew tablets	RXRIM100-180	✓	✓	✓	
	100mg, 60 chew tablets	RXRIM100-60	✓	✓	✓	
	25mg, 60 chew tablets	RXRIM25-60	✓	✓	✓	
	75mg, 180 chew tablets	RXRIM75-180	✓	✓	✓	
	75mg, 60 chew tablets	RXRIM75-60	✓	✓	✓	
Rimadyl Injection *	20ml	RXRIM-INJ	✓	✓	✓	
Roccal-D	gallon	RXROCCAL-D	✓		✓	
Rubenal	300mg, 60 count	RXRUBEN300-60	✓	✓	✓	
	75mg, 60 count	RXRUBEN75-60	✓	✓	✓	
S-Adenosyl	100mg, 60 tablets	RXS-ADEN100	✓	✓	✓	
	100mg, 30 tablets	RXS-ADEN100-30	✓	✓	✓	
	225mg, 30 tablets	RXS-ADEN225-30	✓	✓	✓	
	225mg, 60 tablets	RXS-ADEN225-60	✓	✓	✓	
	425mg, 60 tablets	RXS-ADEN425	✓	✓	✓	
Sandclear Natural Psyllium Crumbles	5 lb	RXSANDCLEAR	✓	✓	✓	
Scarlet Oil	1 gallon	RXSCAR-1GAL	✓			
Schirmer Tear Test	50 strips per box	RXSCHIRMER50	✓		✓	
Scour Halt	1000ml refill	RXSCOUR-HALT	✓			
Sebolux Shampoo	8 oz	RXSEBOLUX-8	✓		✓	
Selegiline Capsules	5mg, 60 capsules	RXSELE5-60		✓		
Selenium Sulfide Shampoo	7 oz	RXSELSUN		✓		
Sentinel Chewable Tablets	Brown, 2-10lbs, 12 months/box	RXSEN-BR-12	✓	✓	✓	
	Green, 11-25lbs, 12 months/box	RXSEN-GR-12	✓	✓	✓	
	Green, 11-25lbs, 6 months/box	RXSEN-GR-6	✓	✓	✓	
	Brown, 2-10lbs, 6 months/box	RXSEN-RE-6	✓	✓	✓	
	White, 51-100lbs, 12 months/box	RXSEN-WH-12	✓	✓	✓	
	White, 51-100lbs, 6 months/box	RXSEN-WH-6	✓	✓	✓	
	Yellow, 26-50lbs, 12 months/box	RXSEN-YE-12	✓	✓	✓	
	Yellow, 26-50lbs, 6 months/box	RXSEN-YE-6	✓	✓	✓	
Sertraline HCl	100mg, 30 tablets	RXSERT100-30		✓		
	50mg, 30 tablets	RXSERT50-30		✓		
Sevoflurane Inhalant Anesthetic	250ml	RXSEVO-250	✓	✓		
Shed-Guard Anti-Shedding Wipes	8/pack	RXWIPE-SHED	✓			
Silver Sulfadiazine Cream	1%, 25 gram tube	RXSSD-25		✓		
	1%, 400 gram jar	RXSSD-400		✓		
	1%, 50 gram jar	RXSSD-50		✓		
Silverlon Contact Dressing	4"x42" roll, 2 rolls/box	RXSILVER-ST	✓		✓	
Silveron Wound Packing	1"x24" , 2 packs/box	RXSILVER-PK	✓		✓	
Simplicef (cefepodoxime)	100mg, 100 tablets	RXSIMPLICEF100	✓	✓	✓	
	200mg, 100 tablets	RXSIMPLICEF200	✓	✓	✓	
Simvastatin	20mg, 90 tablets	RXSIMV20-90		✓		
Slow Release CMPK Boluses	1x50 boluses/pk	RXCMPK-50	✓			
SNP-G Wound Dressing Gel	1.5 ounce tube	RXSNP-G	✓	✓	✓	
Sodium Bicarbonate	8.4%, 50ml	RXNUET-50		✓		



No returns on pharmaceuticals • Prices change frequently please call for current price • Shipping charges for refrigerated items are a flat charge based on your shipping zone.

Customer accepts full responsibility for condition of products upon receipt. ❄ Indicates Refrigerated Shipping • Pictures are for graphic purposes only, actual product may be different.





13822 WEST BOULTON BLVD. METTAWA, IL 60045

WWW.SHOPMEDVET.COM

33

Phone 800-544-7521

Fax 800-204-2177

Product	Size/Details	Product Code	Vet Label	RX	Brand	DEA
Sodium Chloride Ophthalmic Ointment	5%, 3.5gm	RXNACL-OPH		✓		
Sodium Citrate 4% Anticoagulant	250ml	RXSOD-CIT		✓		
Sodium Iodide	20%, 250ml	RXSOD-IOD	✓	✓		
Soloxine (Levothyroxine)		0.1mg, 1000 tablets	RXSLOX.1-1000	✓	✓	✓
		0.2mg, 1000 tablets	RXSLOX.2-1000	✓	✓	✓
		0.2mg, 250 tablets	RXSLOX.2-250	✓	✓	✓
		0.4mg, 250 tablets	RXSLOX.4-250	✓	✓	✓
		0.7mg, 250 tablets	RXSLOX.7-250	✓	✓	✓
		0.6mg, 250 tablets	RXSLOX.6-250	✓	✓	✓
		0.8mg, 1000 tablets	RXSLOX.8-1000	✓	✓	✓
		0.8mg, 250 tablets	RXSLOX.8-250	✓	✓	✓
		0.5mg, 250 tablets	RXSLOXINE0.5	✓	✓	✓
		0.6mg, 1000 tablets	RXSLOX.6-1000	✓	✓	✓
Solu Delta Cortef	100mg/ml, 10ml	RXSOLU-100	✓	✓	✓	
	500mg/ml, 10ml	RXSOLU-500	✓	✓	✓	
Solu-Medrol	500mg, 4ml Act-0-Vial	RXSOLU-MED500		✓	✓	
	25 x 2ml act-o-vial/pack	RXSOLU-MEDROL		✓	✓	
Sorb-A-Tox Suspension	gallon	RXS0AT-G	✓			
	60ml syringe	RXS0AT-SYR	✓			
Spironolactone Tablets	25mg, 100 tablets	RXSPIRO25-100		✓		
	25mg, 1000 tablets	RXSPIRO25-1000		✓		
	50mg, 100 tablets	RXSPIRO50-100		✓		
Sterile Water for Injection		10ml	RXWATER-10		✓	
		100ml bottle	RXWATER-100		✓	
		1 Liter	RXWATER-1L-INJ		✓	
		250ml	RXWATER-250		✓	
		bacteriostatic, 30ml	RXWATER-30		✓	
		50ml	RXWATER-50		✓	
Sterile Water for Irrigation	1 Liter	RXWATER-1L		✓		
	500ml	RXWATER-500		✓		
Strongid Paste	20ml	RXSTRONGI-20	✓		✓	
Sucralfate (carafate)	1gm, 100 tablets	RXCAR1-100		✓		
	1gm, 500 tablets	RXCAR1-500		✓		
Sulf/Trim Suspension	480ml	RXBAC-SUSP		✓		
Sulfa/Trimethoprim (SMZ)	Double Strength, 800/160mg, 100 tablets	RXSMZDS-100		✓		
	Double Strength, 800/160mg, 500 tablets	RXSMZDS-500		✓		
	Single Strength, 400/80mg, 100 tablets	RXSMZSS-100		✓		
	Single Strength, 400/80mg, 500 tablets	RXSMZSS-500		✓		
Sulfadimethoxine Oral Solution	12.5%, gallon	RXSDM-GAL	✓			
Sulfasalazine	500mg, 100 tablets	RXSUL500-100		✓		
	500mg, 500 tablets	RXSUL500-500		✓		
Sumatriptan	6mg/0.5ml, 5/pack	RXSUMA6-0.5X5		✓		
SuperStat Vet	6 discs/box	RXSTAT-6	✓	✓	✓	
Swat Fly Repellent	6oz	RXSWAT-6OZ	✓		✓	
Synotic Otic Solution	8ml	RXSYN-8	✓	✓	✓	
Tamiflu	12mg/ml, 25ml Suspension	RXTAMIFLU		✓	✓	
	75mg, 10 capsules	RXTAMIFLU-CAPS		✓	✓	
Tapazole Tablets	5mg, 100 tablets	RXTAPAZOLE		✓	✓	
Tapeworm (Praziquantel)		Feline, 3 tablets/bottle	RXOTC8783	✓		
		Canine, 5 tablets/bottle	RXOTC8785	✓		
Tattoo Paste	Green, 5oz	RXTATT00-G	✓			
Temaril-P		100 tablets	RXTEMARIL-P100	✓	✓	✓
		1000 tablets	RXTEMARILP-1000	✓	✓	✓

No returns on pharmaceuticals • Prices change frequently please call for current price • Shipping charges for refrigerated items are a flat charge based on your shipping zone. Customer accepts full responsibility for condition of products upon receipt. ❄ Indicates Refrigerated Shipping • Pictures are for graphic purposes only, actual product may be different.

Product	Size/Details	Product Code	Vet Label	RX	Brand	DEA
Terbinafine	250mg, 100 tablets	RXTERBIN250-100		✓		
Terbutaline Injection	1mg, 10 x 1ml/bx	RXTERBUT-INJ		✓		
Terbutaline Sulfate	2.5mg, 100 tablets	RXTERBUT2.5-100		✓		
	5mg, 100 tablets	RXTERBUT5-100		✓		
Tetracaine Ophthalmic Drops	15ml	RXTETRA-15		✓		
Theophylline ER	100mg, 100 tablets	RXTHEO100-100		✓		
	200mg, 100 tablets	RXTHEO200-100		✓		
Thiamine Injection	200mg/ml, 100ml	RXTHIAMINE-100	✓	✓		
Timentin	50ml, 10/pk	RXTIMENTIN		✓		
Timolol Maleate Ophthalmic Solution	0.25%, 5ml	RXTIM.25-10		✓		
	0.5%, 5ml	RXTIM.5-5		✓		
	0.5%, 10ml	RXTIM0.5-10		✓		
	0.5%, 15ml	RXTIM0.5-15		✓		
Tobramycin Injection	40mg/ml, 25x2ml vials/pack	RXTOBRA-INJ40		✓		
Tobramycin Ophthalmic Solution	5ml	RXTOBRA-5		✓		
Tonekote Vitamin A, D, E	16oz	RXMTADE-SUP	✓			
Topiramate	100mg, 500 tablets	RXTOPIR100-500		✓		
Torbugesic (CIV)	10mg/ml, 50ml	RXTORBUG-50	✓	✓	✓	CIV
	10mg/ml, 10ml	RXTORBUG10-10	✓	✓	✓	CIV
Torbugesic-SA (CIV)	2mg/ml, 10ml	RXTORBUG2-10	✓	✓	✓	CIV
Torbutrol (CIV)	1mg, 100 tablets	RXTORB1-100	✓	✓	✓	CIV
	5mg, 100 tablets	RXTORB5-100	✓	✓	✓	CIV
Toxiban Suspension	240ml	RXTOXIBAN	✓		✓	
Toxiban with Sorbitol	240ml	RXTOXIBAN-S	✓		✓	
Tramadol (CIV) Tablets	50mg, 100 tablets	RXTRAM50-100		✓		CIV
	50mg, 500 tablets	RXTRAM50-500		✓		CIV
	50mg, 1000 tablets	RXTRAM50-1000		✓		CIV
Tresaderm *	15ml	RXTRESA15	✓	✓	✓	
	7.5ml	RXTRESA7.5	✓	✓	✓	
Tretinoin	0.025%, 15gm gel	RXTRETINOIN		✓		
	0.1%, 45gm cream	RXTRETINOIN-CR		✓		
Tri-Hist Granules	20oz	RXTRIHIST20	✓	✓	✓	REP
Tri-Otic Ointment	15gm tube	RXOTO-15	✓	✓	✓	
	15gm bottles, 12/pack	RXOTO-15BX12				
	215gm bottle	RXOTO-215	✓	✓	✓	
	25gm bottle	RXOTO-25	✓	✓	✓	
	7.5gm tube	RXOTO-7.5	✓	✓	✓	
Triamcinolone	0.5mg, 1000 tablets	RXTRIAM0.5-1000	✓	✓		
	1.5mg, 500 tablets	RXTRIAM1.5-500	✓	✓		
Triamcinolone Cream	0.1%, 80g	RXKENA-CREAM		✓		
	0.5%, 15gm	RXKENACR.5-15		✓		
Triamcinolone Ointment	0.1%, 80g	RXKENA-OINT		✓		
Triamterene with HCTZ	37.5/25mg, 500 tablets	RXMAXZIDE		✓		
	75/50mg, 500 tablets	RXMAXZIDE75		✓		
Trifectant, powdered	gallon	RXTRIFECTANT	✓	✓		
Triforce Flea and Tick Preventive	Feline, greater than 5lbs, 3 month	RXTRIFORCE-LG	✓		✓	
	Feline, 2.2-5lb, 3 month	RXTRIFORCE-SM	✓		✓	
Triple Antibiotic Ointment	15gm	RXTRIP-OI15				
	30gm	RXTRIP-OI30				
Triple Antibiotic Plus Pain Reliever	15gm	RXTRIP-PLUS				
	30gm	RXTRIP-PLUS30				
Triple-Antibiotic Ointment, .9g Foil Packet	144 Foil Packs/Box	CUR001209Z				
TrizCHLOR 4 Shampoo	1 gallon	RXTRIZCHLOR4-GA	✓		✓	
TrizEDTA Aqueous Flush	4oz	RXTRIED-FL	✓		✓	



No returns on pharmaceuticals • Prices change frequently please call for current price • Shipping charges for refrigerated items are a flat charge based on your shipping zone.

Customer accepts full responsibility for condition of products upon receipt. ❄ Indicates Refrigerated Shipping • Pictures are for graphic purposes only, actual product may be different.

Product	Size/Details	Product Code	Vet Label	RX	Brand	DEA
TrizEDTA Crystals	4oz	RXTRIED-CR	✓		✓	
Tropicamide Ophthalmic Suspension	1%, 15ml	RXTROPICAMIDE15		✓		
Tucoprim Powder	400gm	RXTUCO-400	✓	✓	✓	
Tumil-K 	5oz gel	RXTUMIL-GEL	✓	✓	✓	
	2meq, 100 tablets	RXTUMIL-K	✓	✓	✓	
	4oz powder	RXTUMIL-POW	✓	✓	✓	
Tylan Injection	200mg/ml, 250ml	RXTYLAN200-250	✓	✓	✓	
Tylan Soluble	100gm	RXTYLAN100GM	✓	✓	✓	
UAA Gel	300ml	RXUAA-8	✓			
	60ml Dial-a-Dose syringe	RXUAA-SYR	✓			
Ultra Drench 2000 	32 oz.	RXDRENCH-32	✓			
Unasyn 	1.5gm vial, 10 vials/pack	RXUNASYN		✓	✓	
Uniprim Powder	67/333mg, 37.5gm packet	RXUNIPRIM	✓	✓	✓	
Urine-Off	for Dogs 500ml, veterinary strength	RXURINE-OFF			✓	
	for Cats 500ml, veterinary strength	RXURINE-OFF-CAT			✓	
Urozeze Tablets	200mg, 500 tablets	RXURO200-500	✓	✓	✓	
	400mg, 500 tablets	RXURO400-500	✓	✓	✓	
Ursodiol Capsules	300mg, 100 capsules	RXURSODIOL		✓		
Vaccine-Bimeda-DAPP *	Canine, 10x1 dose/pack, Primemune	RXV-DAPP-BIM1	✓		✓	
Vaccine-East/West Encephalitis + Tetanus *	Equine, 1 dose, Equiloid Innovator	RXV-EQ-EWE-TET	✓		✓	
Vaccine-Equine Influenza/Rhino*	Equine, 1 dose, Fluvac Innovator EHV 4/1	RXV-EQ-INF/RH1	✓		✓	
Vaccine-Fort Dodge-DAPP *	Canine, 25x1 dose/pack, Duramune Max 5	RXV-DAPP-FD1	✓		✓	
Vaccine-Fort Dodge-DAPP + CVK *	Canine, 25x1 dose/pack, Duramune Max 5 + CVK	RXV-DAPPC-FD1	✓		✓	
Vaccine-Fort Dodge-DAPP + CVK/4L *	Canine, 25x1 dose/pack, Duramune Max 5 + CVK/4L	RXV-DAPPC4L-FD1	✓		✓	
Vaccine-Fort Dodge-DAPP+4L *	Canine, 25 x 1 dose/pack, Duramune Max 5/4L	RXV-DAPP4L-FD1	✓		✓	
Vaccine-Fort Dodge-East/West Encephalitis + Tetanus *	Equine, 10 dose tank, Equiloid Innovator	RXV-EQ-EWT10	✓		✓	
Vaccine-Fort Dodge-Eastern/Western Encephalitis, Influenza-Tetanus *	Equine, 10 dose tank, Fluvac Innovator 4	RXV-FLUVAC4-10	✓		✓	
Vaccine-Fort Dodge-Flu *	Equine, 10 dose tank, Fluvac Innovator	RXV-FLUVAC1-10	✓		✓	
Vaccine-Fort Dodge-Influenza/Rhino *	Equine, 10 dose tank, Fluvac Innovator EHV-4/1	RXV-FLU-EHV4-10	✓		✓	
Vaccine-Fort Dodge-Leptospirosis (4 serovar) *	canine, 25x1 dose/tray, LeptoVax 4	RXV-LEPTO4-FD1	✓		✓	
Vaccine-Fort Dodge-Lyme *	canine, 50x1 dose/pack, LymeVax	RXV-LYME-FD1	✓		✓	
Vaccine-Fort Dodge-Rabies 1 year *	Canine, Feline, 10 dose tank, Rabvac 1	RXV-RAB1FD10	✓	✓	✓	
	Canine, Feline 50x1 dose/pack, Rabvac 1 TP	RXV-RAB1Y-FD1	✓	✓	✓	
Vaccine-Fort Dodge-Rabies 3 year *	Canine, Feline, Equine, 50x1 dose/pack, Rabvac 3 TP	RXV-RAB3Y-FD1	✓	✓	✓	
Vaccine-Fort Dodge-Rabies 3 Year *	Canine, Feline, Equine, 10 dose tank, Rabvac 3	RXV-RAB3Y-FD10	✓	✓	✓	
Vaccine-Fort Dodge-RCCP *	Feline, 50x1 dose/pack, Felovax IV	RXV-RCCP-FD1	✓		✓	
Vaccine-Fort Dodge-RCP *	Feline, 50x1 dose/pack, Felovax PCT	RXV-RCP-FD1	✓		✓	
Vaccine-Fort Dodge-Strep Intranasal *	Equine, 10x1 dose/pack, Pinnacle IN	RXV-EQ-STREP-FD	✓		✓	
Vaccine-Fort Dodge-Tetanus Antitoxin *	Equine, 10x1 dose/pack	RXV-TET-ANTI-1	✓		✓	
Vaccine-Fort Dodge-Tetanus Toxoid *	Equine, 10 dose tank	RXV-TET-TOX-10	✓		✓	
Vaccine-Fort Dodge-West Nile *	Equine, 10 dose tank, West Nile Innovator	RXV-WESTNILE10	✓		✓	
Vaccine-Fort Dodge-West Nile + Eastern/Western Encephalitis + Tetanus *	Equine, 10 dose tank, West Nile Innovator + EWT	RXV-NILE-EWT	✓		✓	

No returns on pharmaceuticals • Prices change frequently please call for current price • Shipping charges for refrigerated items are a flat charge based on your shipping zone. Customer accepts full responsibility for condition of products upon receipt. ❄ Indicates Refrigerated Shipping • Pictures are for graphic purposes only, actual product may be different.

Product	Size/Details	Product Code	Vet Label	RX	Brand	DEA
Vaccine-Intervet-Bordetella *	feline, 25x1 dose/pack, Protex BB	RXV-BORD-IN1	✓		✓	
Vaccine-Intervet-Distemper and Parvo *	Canine, 25x1 dose/pack, Proguard D + PV	RXV-DPV-INV1	✓		✓	
Vaccine-Intervet-Influenza Intranasal *	Equine, 10 x 1 dose/pack, Flu-Avert	RXV-EQ-FLUAVERT	✓		✓	
Vaccine-Merial-Potomac Fever *	equine, 5x1ds/pk, Potomac Vac	RXV-EQPOT-MER5	✓		✓	
Vaccine-Pfizer-Parvovirus + Coronavirus *	Canine, 10 dose tank, Vanguard Plus CPV	RXV-PC-FD10	✓		✓	
Vaccine-Schering-Bordetella Intranasal*	Canine, 25x1 dose/pack, Intra-Trac 3	RXV-BORD3-SP1	✓		✓	
Vaccine-Schering-DAPP *	Canine, 25x1 dose/pack, Galaxy DA2PPV	RXV-DAPP-SP1	✓		✓	
Vaccine-Schering-DAPPC *	Canine, 25x1 dose/pack, Galaxy DA2PPV + CV	RXV-DAPPC-SP1	✓		✓	
Vaccine-Schering-DAPPL *	Canine, 25x1 dose/pack, Galaxy DA2PPV	RXV-DAPPL-SP1	✓		✓	
Vaccine-Schering-DAPPL+CV *	Canine, 25x1 dose/pack, Galaxy DA2PPV + CV	RXV-DAPPLC-SP1	✓		✓	
Vaccine-Schering-Feline Leukemia *	Feline, 25x1 dose/pack, Fevaxyn FELV	RXV-FELV-SP1	✓		✓	
Vaccine-Schering-Parvo *	Canine, 25x1 dose/pack, Galaxy PV	RXV-PARVO-SP1	✓		✓	
Vaccine-Schering-Rabies 1 year *	Canine, Feline, 10 dose tank, Rabdomun 1	RXV-RAB1Y-SP10	✓	✓	✓	
Vaccine-Schering-Rabies 3 Year *	Canine, Feline, 50x1 dose/pack, Rabdomun	RXV-RAB3Y-SP1	✓	✓	✓	
	Canine, Feline, 10 dose tank, Rabdomun	RXV-RAB3Y-SP10	✓	✓	✓	
Vaccine-Schering-RCCP *	Feline, 25x1 dose/pack, Eclipse 4	RXV-RCCP-SP1	✓		✓	
Vaccine-Schering-RCCP + FELV *	Feline, 25x1 dose/pack, Eclipse 4 + FELV	RXV-RCCPFL-SP1	✓		✓	
Vaccine-Schering-RCP *	Feline, 25x1 dose/pack, Eclipse 3	RXV-RCP-SP1	✓		✓	
Vaccine-Schering-RCP+FELV *	feline, 25x1 dose/pack, Eclipse 3 + FELV	RXV-RCPFL-SP1	✓		✓	
Vancomycin Hydrochloride Injection	500mg	RXVANCO500INJ		✓		
Vasopressin Injection	20 units/ml, 25x1 ml/box	RXVASOPRESSIN		✓		
Vecuronium Powder for Injection	10 x 10mg	RXVECUR10X10		✓		
Ventipulmin Syrup	100ml	RXVENTI-SY	✓	✓	✓	
Verapamil ER	240mg, 100 tablets	RXVERA240-100		✓		
	240mg, 500 tablets	RXVERA240-500		✓		
	180mg, 100 tablets	RXVERAP180ER		✓		
Verruca-Freeze	starter kit: 60-70 freezes with cones and buds	RXVERRUCA		✓	✓	
	Soft tip cones, 5/pk	RXVERRUCA-CONES		✓	✓	
	Cryo Buds large, 8-10mm, 30/pk	RXVERRUCA-L		✓	✓	
	Cryo Buds medium 4-6mm, 30/pk	RXVERRUCA-M		✓	✓	
	mini kit: 30-35 freezes with cones and buds	RXVERRUCA-MINI		✓	✓	
	mini replacement canister: 30-35 freezes	RXVERRUCA-MINIR		✓	✓	
	Refill Canister: 60-70 freezes	RXVERRUCA-REF		✓	✓	
	Cryo Buds small, 2mm, 30/pk	RXVERRUCA-S		✓	✓	
Vetalog Injection	2mg/ml, 100ml	RXVETLOG-100	✓	✓	✓	
	2mg/ml, 25ml	RXVETLOG-INJ	✓	✓	✓	
Vetisulid Powder	54g	RXVETISULID	✓		✓	
Vetmedin	1.25mg, 50 tablets	RXVETMEDIN	✓	✓	✓	
	5mg, 50 tablets	RXVETMEDIN5	✓	✓	✓	
Vetoryl (Trilostane)	10mg, 30 capsules	RXVETORYL10	✓	✓	✓	
	30mg, 30 capsules	RXVETORYL30	✓	✓	✓	
	60mg, 30 capsules	RXVETORYL60	✓	✓	✓	
		RXVETORYL120				
Vetprofen	100mg, 240 tablets	RXVETPROFEN	✓	✓	✓	
	75mg, 240 caplets	RXVETPROFEN75	✓	✓	✓	
Viagra Tablets	100mg, 30 tablets	RXVIAGRA100-30		✓	✓	
	50mg, 30 tablets	RXVIAGRA50-30		✓	✓	
Vincristine Injection *	1mg/ml, 1ml	RXVINCRIS-1		✓		
VIP Fly Repellent Ointment	2oz	RXVIP-FLY-OINT	✓			
Viralys Gel	5 oz.	RXVIRALYS-GEL	✓	✓	✓	

No returns on pharmaceuticals • Prices change frequently please call for current price • Shipping charges for refrigerated items are a flat charge based on your shipping zone. Customer accepts full responsibility for condition of products upon receipt. ❄ Indicates Refrigerated Shipping • Pictures are for graphic purposes only, actual product may be different.

Product	Size/Details	Product Code	Vet Label	RX	Brand	DEA
Viralys Powder	100gm	RXVIRALYS-100	✓	✓	✓	
	600gm	RXVIRALYS-600	✓	✓	✓	
Vita Tabs for Dogs & Cats	50 tablets	RXVITATAB-50	✓		✓	
Vitamin B Complex	100ml vet label	RXMTB-100	✓	✓		
	250ml vet label	RXMTB-250	✓	✓		
	30ml	RXMTB-30		✓		
Vitamin B12 Injection	1000mcg, 100ml vet label	RXMTB12-100	✓	✓		
	1000mcg, 1ml, 25/pack	RXMTB12-1ML		✓		
	1000mcg, 250ml vet label	RXMTB12-250	✓	✓		
	3000mcg, 100ml vet label	RXMTB12-3K-100	✓	✓		
	5000mcg, 100ml vet label	RXMTB12-5K-100	✓	✓		
	1000mcg, 30ml	RXMTB12-INJ		✓		
Vitamin C	100 tablets	RXVTC-100	✓	✓		
Vitamin C Injection	250ml	RXVTC-250	✓	✓		
Vitamin K Injection	10mg/ml, 100ml	RXVTKINJ100	✓	✓		
Vitamin K1	25mg, 50 capsules	RXMTK-50	✓	✓		
Vitamin K1 Chewables	25mg, 50 chewable tablets	RXMTKCH-25	✓	✓		
	50mg, 50 chewable tablets	RXMTKCH-50	✓	✓		
Warfarin Sodium Tablets	5mg, 100 tablets	RXCUMS-100		✓		
Welactin For Cats	60 soft gels	RXWELACTIN-C	✓	✓	✓	
Welactin For Dogs	120 soft gels	RXWELACTIN-D	✓	✓	✓	
White Petrolatum USP	1oz	RXPETRO-1				
Witness FeLV Test Kit	10 tests/kit	RXWITFELV-10	✓		✓	
Witness Heartworm Antigen Test	25 tests/box	RXWITHW-25	✓		✓	
Witness Parvo Test	10 tests/box	RXWITPARVO-10	✓		✓	
Witness Relaxin Test	5 tests/box	RXWIT-RELAX	✓		✓	
Xalatan Ophthalmic Solution *	2.5ml	RXXALATAN-2.5		✓	✓	
Xenodine (Iodine)	12oz bottle	RXXENODINE	✓			
Xylazine (Anased) Injection	20mg/ml, 20ml	RXANASED-20	✓	✓	✓	
Xylazine Injection	100mg/ml, 50ml	RXXYLAZINE	✓	✓		
Xylocaine Brand Injection	2%, 50ml	RXXYLOCAINE2-50		✓	✓	
Yohimbine Injectable	2mg/ml, 20ml	RXYOHIMBINE	✓	✓	✓	
Yuk-2e Anti-Lick Gel	0.5oz	RXYUK-0.5	✓		✓	
Zeniquin Tablets	100mg, 50 tablets	RXZEN100-50	✓	✓	✓	
	25mg, 100 tablets	RXZEN25-100	✓	✓	✓	
	50mg, 100 tablets	RXZEN50-100	✓	✓	✓	
Zentonil Plus	100mg, 30 tablets/box	RXZEN100-30	✓	✓	✓	
	200mg, 30 tablets/box	RXZEN200-30	✓	✓	✓	
	400mg, 30 tablets/box	RXZEN400-30	✓	✓	✓	
Zolpidem Tartrate (CIV)	10mg, 100 tablets	RXZOLP10-100		✓		CIV
Zonisamide	100mg 100ct	RXZONIS100-100		✓		
Zymox Ear Cleanser	4oz	RXZYM-4OZ	✓		✓	
Zymox Medicated Rinse	12oz	RXZYMRIN-12	✓		✓	
Zymox Medicated Shampoo	12oz	RXZYMSHA-12	✓		✓	
Zymox Otic	1.25oz	RXZYMWO-125	✓		✓	
Zymox Otic with HCL	1.25oz	RXZYM-1.25	✓		✓	
Zymox Topical Cream	1oz	RXZYMTCRW/O	✓		✓	
Zymox Topical Cream with HCL	1oz	RXZYMTCR-1	✓		✓	
Zymox Topical Spray	2.5oz	RXZYMTSPW/O	✓		✓	
Zymox Topical Spray with HCL	2.5oz	RXZYMTSP-2	✓		✓	
Zymox Topical Wipes	30 wipes/pk	RXZYMTWIW/O	✓		✓	

No returns on pharmaceuticals • Prices change frequently please call for current price • Shipping charges for refrigerated items are a flat charge based on your shipping zone. Customer accepts full responsibility for condition of products upon receipt. ❄ Indicates Refrigerated Shipping • Pictures are for graphic purposes only, actual product may be different.

PHARMACEUTICAL POLICIES

Controlled Substances:

License is required. Controlled Substances will be shipped to the address listed on the DEA license only. For Schedule 2 & 2n Controlled Substances, see DEA 222 form instructions below.

Cold Shipping:

Shipping charges for refrigerated items are a flat charge based on Shipping Zone.

Fluids Freight:

Fluids are limited to 2 liters under normal freight policy. Additional fluids are billed at actual freight.

Hazardous Material Shipping:

Isoflurane, Sevoflurane, Ethyl Chloride and any other products classified as Hazardous Materials/Dangerous Goods will be shipped exclusively via ground service.

Return Policy:

Customer accepts full responsibility for condition of products upon receipt. No returns on Pharmaceuticals

Price Change Policy:

Prices change frequently please call for current price

Pedigree

To obtain Pedigree Information for purchased pharmaceuticals visit www.shopmedvet.com/pedigree

*Note we only sell pharmaceuticals to licensed medical professionals, we DO NOT fill prescriptions.



Instructions for completing a: DEA 222 form to order Schedule 2 and 2n Controlled Substances

Fill in Date

See Reverse of PURCHASER'S Copy for Instructions		No order form may be issued for Schedule I and II Substances unless a completed application form has been received. (21 CFR 1305.04)		OMB APPROVAL No. 1117-0019		
TO: (Name of Supplier) MED-VET INTERNATIONAL			STREET ADDRESS 13822 W BOULTON BLVD			
CITY and STATE: METTAWA, IL			DATE: XX/XX/XX			
TO BE FILLED IN BY PURCHASER			TO BE FILLED IN BY SUPPLIER			
SUPPLIER'S DEA REGISTRATION No.						
No.	No. of Packages	Size of Package	Name of Item	National Drug Code	Packages Shipped	Date Shipped
1	1	5	Fentanyl Transdermal Patch 25mcg/hr			
2	2	250cc	Fetal Plus, Sodium Pentobarbital, 6 grain/mL			
3	5	20cc	Hydromorphone 2mg/mL			
SAMPLE						
LAST LINE COMPLETED (MUST BE 10 OR LESS) 3			SIGNATURE OF PURCHASER OR ATTORNEY OR AGENT BE SURE TO SIGN			
Date Issued: 01/28/2010	DEA Registration No. BA*****	Name and Address of Registrant				
Schedules: 2, 2N, 3, 3N, 4, 5		ABC Veterinary Clinic 123 Main Street Anywhere, USA 123456				
Registered as a Practitioner	No. of this Order Form: 123456789					
DEA Form 222 (MAR 2002)		U.S. OFFICIAL ORDER FORMS - SCHEDULES I & II			12*****	
		DRUG ENFORCEMENT ADMINISTRATION			SUPPLIER'S Copy 1	

Address on Form
MED-VET INTERNATIONAL
13822 W Boulton Blvd
Mettawa, IL 60045

SAVE THIS WITH YOUR 222 ORDER FORMS FOR FUTURE REFERENCE

Address on Envelope
MED-VET INTERNATIONAL
13822 W Boulton Blvd
Mettawa, IL 60045

ABC Veterinary Clinic
123 Main Street
Anywhere, USA 123456

MED-VET INTERNATIONAL
13822 W Boulton Blvd
Mettawa, IL 60045

Signature required or form is invalid

Last Line Completed: Enter only the number of lines used. In the example above, the last line completed would be 3.

Listed below is detailed information to help you in filling out the DEA form 222 for class 2 and 2n drugs. This is only to be used in ordering class 2 and 2n drugs.

- Product will be shipped to the address on the dea license only
- Form 222 can contain no corrections or strike-over marks
- Use the following Med-Vet International address on the request form:
13822 W Boulton Blvd, Mettawa, IL 60045
- Please keep customer copy (blue copy) and mail remaining copies for processing to: 13822 W Boulton Blvd, Mettawa, IL 60045
- Be sure to refer to the back of the blue copy of your 222 form for complete instructions



PDO II-MONOFILAMENT ABSORBABLE SUTURE

COMPARE TO

PDSII®



- Excellent Knot Security: Designed for secure knotting
- Smooth Monofilament: Minimizes tissue trauma by allowing easy passage
- Gradual Absorption Rate: Absorbs between 180-220 days after placement
- Excellent Pliability: Makes suturing easier by handling like a braided suture
- Excellent Holding Strength: Retains 50% of tensile strength for up to 6 weeks after procedure

TAPERPOINTNEEDLES

Item#	Size	Needle	Qty	Length
MV-Z310	4-0	NSH-1	12/bx	30"
MV-Z315	4-0	NSH	12/bx	30"
MV-Z311	3-0	NSH-1	12/bx	30"
MV-Z316	3-0	NSH	12/bx	30"
MV-Z332	3-0	NCT-2	12/bx	30"
MV-Z317	2-0	NSH	12/bx	30"
MV-Z333	2-0	NCT-2	12/bx	30"
MV-Z339	2-0	NCT-1	12/bx	30"
MV-Z334	0	NCT-2	12/bx	30"
MV-Z340	0	NCT-1	12/bx	30"
MV-Z341	1	NCT-1	12/bx	30"

REVERSECUTTINGNEEDLES

Item#	Size	Needle	Qty	Length
MV-Z397	4-0	NFS-2	12/bx	30"
MV-Z398	3-0	NFS-2	12/bx	30"
MV-Z452	3-0	NFS-1	12/bx	30"
MV-Z451	2-0	NFS-1	12/bx	30"
MV-Z466	2-0	NCP-1	12/bx	30"
MV-Z587	0	NFSL	12/bx	30"
MV-Z467	0	NCP-1	12/bx	30"
MV-Z468	1	NCP-1	12/bx	30"

\$34⁰⁰
/Dz

(VET USE ONLY)

BUY NOW

PDO CASSETTE SUTURE

- Composition: Polydioxanone
- Absorption Type: Hydrolysis
- Structure: Monofilament
- Thread Color: Violet

Item#	Size	Length	Price
PD30	Cassette 3-0	15M	\$39.60
PD20	Cassette 2-0	15M	\$45.60
PD10	Cassette 0	15M	\$54.40
PD01	Cassette 1	15M	\$57.60
PD02	Cassette 2	15M	\$67.20





(VET USE ONLY)

Starting at
\$39⁶⁰/ea

BUY NOW

NEEDLE CHART Super Sharp Point Siliconized Needles



1/2 CIRCLE TAPER POINT		 Taper Point	3/8 CIRCLE REVERSE CUTTING		 Reverse Cutting
Needle	Size		Needle	Size	
NSH-1	22mm	NFS-2	19mm		
NSH	26mm	NFS-1	24mm		
NCT-2	27mm	NFS	26mm		
NCT-1	36mm	NFSL	30mm		
		1/2 CIRCLE REVERSE CUTTING POINT			
		Needle	Size		
		NCP-2	27mm		
		NCP-1	36mm		
		NX-1	23mm		

Suture and Skin Closure

Braided Absorbable Suture



PGA-BRAIDED ABSORBABLE SUTURE

- Extremely Strong: Retains 60%-70% tensile strength at 14 days
- Excellent Knot Security: Precision braided construction designed to provide secure knotting
- Extremely Smooth: Unique calcium stearate coating ensures smooth tissue passage with minimal trauma to tissue
- Rapid Absorption Rate: Absorbs between 60-90 days after placement
- Excellent Pliability: Braided construction allows for excellent handling properties



COMPARE TO
VICRYL®

\$28.00
/dz

BUY NOW

TAPERPOINT NEEDLES

Item#	Size	Needle	Qty	Length
MV-J310	4-0	NSH-1	12/bx	30
MV-J315	4-0	NSH	12/bx	30
MV-J332	3-0	NCT-2	12/bx	30
MV-J338	3-0	NCT-1	12/bx	30
MV-J311	3-0	NSH-1	12/bx	30
MV-J316	3-0	NSH	12/bx	30
MV-J333	2-0	NCT-2	12/bx	30
MV-J339	2-0	NCT-1	12/bx	30
MV-J317	2-0	NSH	12/bx	30
MV-J334	0	NCT-2	12/bx	30
MV-J340	0	NCT-1	12/bx	30
MV-J318	0	NSH	12/bx	30
MV-J341	1	NCT-1	12/bx	30

REVERSE CUTTING NEEDLES

Item#	Size	Needle	Qty	Length
MV-J397	4-0	NFS-2	12/bx	30
MV-J451	4-0	NFS-1	12/bx	30
MV-J398	3-0	NFS-2	12/bx	30
MV-J452	3-0	NFS-1	12/bx	30
MV-J460	3-0	NX-1	12/bx	30
MV-J466	2-0	NCP-1	12/bx	30
MV-J453	2-0	NFS-1	12/bx	30
MV-J461	2-0	NX-1	12/bx	30
MV-J587	0	NFSL	12/bx	30
MV-J467	0	NCP-1	12/bx	30
MV-J468	1	NCP-1	12/bx	30

PGA SUTURE CASSETTE



(VET USE ONLY)

- Composition: Polyglycolic Acid
- Absorption Type: Hydrolysis
- Structure: Braided
- Thread Color: Violet
- Coating: Calcium Stearate

\$29.95/ea
Starting at

Item#	Size	Length	Price	
PG30	Cassette	3-0	15M	\$29.95
PG20	Cassette	2-0	15M	\$34.95
PG10	Cassette	0	15M	\$41.95
PG01	Cassette	1	15M	\$43.95
PG02	Cassette	2	15M	\$61.95
PG03	Cassette	3	15M	\$69.95

BUY NOW

NEEDLE CHART Super Sharp Point Siliconized Needles



1/2 CIRCLE TAPER POINT

Needle	Size
NSH-1	22mm
NSH	26mm
NCT-2	27mm
NCT-1	36mm



Taper Point

3/8 CIRCLE REVERSE CUTTING

Needle	Size
NFS-2	19mm
NFS-1	24mm
NFS	26mm
NFSL	30mm

1/2 CIRCLE REVERSE CUTTING POINT

Needle	Size
NCP-2	27mm
NCP-1	36mm
NX-1	23mm



Reverse Cutting

13822 WEST BOULTON BLVD. METTAWA, IL 60045

WWW.SHOPMEDVET.COM

Phone 800-544-7521

Fax 800-204-2177

Suture and Skin Closure

Monofyl & Nylon Suture



MONOFYL ABSORBABLE SUTURE



(VET USE ONLY)



- MONOFYL is a monofilament synthetic absorbable surgical suture prepared from a copolymer of glycolide and epsilon-caprolactone. The chemical composition is similar to Ethicon Monocryl.
- MONOFYL retains approximately 50%-60% of its original strength 7 days post implantation. Absorption of MONOFYL absorbable synthetic is essentially complete between 91 and 119 days.

COMPARE TO
MONOCRYL®



\$35.00
/dz

BUY NOW

REVERSE CUTTING NEEDLES

Item#	Size	Needle	Qty/box	Length
MV-Y922	4-0	NFS-2	12/box	30
MV-Y923	3-0	NFS-2	12/box	30
MV-Y942	3-0	NFS-1	12/box	30
MV-Y943	2-0	NFS-1	12/box	30
MV-Y987	0	NFSL	12/box	30
MV-Y967	0	NCP-1	12/box	30

TAPER POINT NEEDLES

Item#	Size	Needle	Qty/box	Length
MV-Y344	3-0	NCT-1	12/box	30
MV-Y345	2-0	NCT-1	12/box	30
MV-Y346	0	NCT-1	12/box	30

NYLON SUTURE

BUY NOW

COMPARE TO

ETHILON®

- Extremely Strong: High tensile strength suture that exceeds USP requirements
- Excellent Knot Security: Designed for secure knotting
- Extremely Smooth: surface allows for easy passage through tissue

REVERSE CUTTING NEEDLES

Item#	Size	Needle	Qty	Length
MV-661	5-0	NFS-2	12/box	30"
MV-662	4-0	NFS-2	12/box	30"
MV-1629	4-0	NFS-1	12/box	30"
MV-663	3-0	NFS-1	12/box	30"
MV-664	2-0	NFS	12/box	30"
MV-N666	1	NFSL	12/box	30"
MV-N665	0	NFSL	12/box	30"

\$17.48
/dozen



NYLON SUTURE CASSETTE

BUY NOW

- Composition: Polyamide
- Absorption Type: Non-absorbable
- Structure: Monofilament
- Thread Color: Black

Item#	Size	Length	Price
MF30	Cassette 3-0	100M	\$28.98
MF20	Cassette 2-0	100M	\$29.12
MF10	Cassette 0	75M	\$29.76
MF01	Cassette 1	75M	\$29.76
MF02	Cassette 2	50M	\$28.98
MF03	Cassette 3	50M	\$29.95

Starting at

\$28.98

Vet Use Only

13822 WEST BOULTON BLVD. METTAWA, IL 60045

WWW.SHOPMEDVET.COM

Phone 800-544-7521

Fax 800-204-2177



CHROMIC GUT SUTURE



- **Extremely Strong:** Very high tensile strength
- **Excellent Knot Security:** Designed to provide secure knotting
- **Excellent Pliability & Flexibility:** Designed to be more pliable & flexible

TAPERPOINT NEEDLES

Item#	Size	Needle	Qty	Length
MV-G121	4-0	NSH	12/bx	30"
MV-810	3-0	NCT-1	12/bx	30"
MV-G122	3-0	NSH	12/bx	30"
MV-883	2-0	NCT-2	12/bx	30"
MV-811	2-0	NCT-1	12/bx	30"
MV-G123	2-0	NSH	12/bx	30"
MV-812	0	NCT-1	12/bx	30"
MV-884	0	NCT-2	12/bx	30"
MV-813	1	NCT-1	12/bx	30"

REVERSE CUTTING NEEDLES

Item#	Size	Needle	Qty	Length
MV-635	4-0	NFS-2	12/bx	30"
MV-636	3-0	NFS-2	12/bx	30"
MV-637	2-0	NFS-1	12/bx	30"
MV-638	0	NFS	12/bx	30"
MV-817	0	NCP-1	12/bx	30"
MV-888	0	NCP-2	12/bx	30"

\$19²⁸
/dozen

BUY NOW

PLAIN GUT SUTURE

Item#	Size	Needle	Qty	Length
MV-H821	4-0	NFS-2	12/bx	30"
MV-H822	3-0	NFS-2	12/bx	30"

Super Sharp Point Siliconized Needles

CHROMIC GUT SUTURE CASSETTE



BUY NOW

Vet Use Only

Starting at

\$51⁹²

- **Composition:** Natural Purified Collagen
- **Absorption Type:** Absorbable
- **Structure:** Natural
- **Thread Color:** Brown

Item#	Size	Length	Price
CG30	Cassette	3-0 50M	\$51.92
CG20	Cassette	2-0 50M	\$51.92
CG10	Cassette	0 50M	\$58.60
CG01	Cassette	1 50M	\$67.95
CG02	Cassette	2 50M	\$69.95
CG03	Cassette	3 50M	\$79.95

NEEDLE CHART *Super Sharp Point Siliconized Needles*



1/2 CIRCLE TAPER POINT

Needle	Size
NSH-1	22mm
NSH	26mm
NCT-2	27mm
NCT-1	36mm



Taper Point

3/8 CIRCLE REVERSE CUTTING

Needle	Size
NFS-2	19mm
NFS-1	24mm
NFS	26mm
NFSL	30mm

1/2 CIRCLE REVERSE CUTTING POINT

Needle	Size
NCP-2	27mm
NCP-1	36mm
NX-1	23mm



Reverse Cutting

Suture and Skin Closure

Polypropylene, Silk Suture & Braun Cassettes



POLYPROPYLENE SUTURE



REVERSE CUTTING NEEDLES
Blue Polypropylene Synthetic
Non-absorbable Suture

\$22.00 /dozen



BUY NOW

Item#	Size	Needle	Qty	Length
Reverse Cutting Needles				
MV-8661	5-0	NFS-2	12/bx	30"
MV-8683	4-0	NFS-2	12/bx	30"
MV-8665	3-0	NFS-2	12/bx	30"
MV-8684	3-0	NFS-1	12/bx	30"
MV-8685	2-0	NFS	12/bx	30"
Tapper Point Needles				
MV-8870	5-0	NRB-1	12/bx	30"
MV-8831	4-0	NSH	12/bx	30"
MV-8422	3-0	NCT-1	12/bx	30"
MV-8423	2-0	NCT-1	12/bx	30"

SILK SUTURE

Black Braided Suture
From Oasis

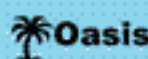

Starting At
\$9.99 /dozen



BUY NOW

Item#	Size	Needle	Qty	Length	Price
MV-682	5-0	NFS-2	12/bx	30"	\$9.95/bx
MV-683	4-0	NFS-2	12/bx	30"	\$9.95/bx
MV-629	4-0	NFS-1	12/bx	30"	\$9.95/bx
MV-684	3-0	NFS-1	12/bx	30"	\$9.95/bx
MV-685	2-0	NFS	12/bx	30"	\$9.95/bx
Ophthalmic Silk Suture					
MV-711	6-0	NC-3	12/bx	30"	\$19.95/bx

Braunamid Cassette Suture

Suture consists of a large number of fine twisted strands covered by a smooth, seamless, homogeneous polyamide cover. Because of its polyfil construction, Braunamid thread is considerably more flexible than monofil sutures. Knot-pull tensile strength substantially exceeds USP requirements. Knot-holding ability is excellent due to its inner polyfilament structure. Non-capillary. Sterilized. Braunamid meets or exceeds all legal requirements set forth by the U.S. government.

JOR91-4/0	Size 4/0 USP, 100m (328") L	\$33.00/pk
JOR9100	#0, 75m, Heavy	\$45.00/ea
JOR91-6	Size 6 USP, 25m (82") L	\$42.00/pk
JOR91-8	Size 8 USP, 25m (82") L	\$45.00/pk

BUY NOW

Pre-Cut Braunamid

In addition to the well-known Braun suture cassettes and Braun needle-suture, we can now provide Braun suture in pre-cut lengths. White. Sterile. Individually packaged.

JOR91PC0	60" Length	\$3.00 /ea
JOR91PC3	60" Length	\$3.60 /ea

Safil Cassette Sutures

JOR91SG2	#2 - 15m	\$45.00/ea
JOR91SG5	#5 - 25m	\$111.00/ea



Braun Catgut Cassette Suture

Manufactured under continuous supervision from selected materials processed to high quality standards. It is accurately gauged and evenly chromed. High knot-pull tensile strength. Good knot-holding ability and exceptionally good handling qualities. Sterilized.

JOR91C0	Size 0 USP, 50m (164") L	\$99.00/ea
JOR91C1	Size 1 USP, 50m (164") L	\$105.00/ea
JOR91C2	Size 2 USP, 50m (164") L	\$123.00/ea
JOR91C2/0	Size 2/0 USP, 50m (164") L	\$82.50/ea
JOR91C3	Size 3/0 USP, 50m (164") L	\$139.50/ea
JOR91C3/0	Size 3/0 USP, 50m (164") L	\$67.50/ea
JOR91C4	Size 4 USP, 25m (82") L	\$96.00/ea
JOR91C4/0	Size 4/0 USP, 50m (164") L	\$75.00/ea

BUY NOW



Braun Catgut Cassette Suture (Non-Chromic)

JOR91C6P	Size 6p USP, 25m (82") L	\$108.90/ea
----------	--------------------------	-------------

Braun Stainless Steel Cassette Suture

Stainless Steel Suture. Monofilament, corrosion-resistant steel. Extremely high knot-pull tensile strength. Stitch holds for an unlimited period of time. Sterilized.

JOR91S40	4/0, 50m (164")L	\$30.00/ea
JOR91S30	3/0, 50m (164")L	\$30.00/ea
JOR91S20	2/0, 50m (164")L	\$30.00/ea
JOR91S0	0, 50m (164")L	\$30.00/ea
JOR91S1	1, 25m (82")L	\$30.00/ea
JOR91S2	2, 25m (82")L	\$30.00/ea
JOR91S3	3, 20m (65")L	\$46.50/ea



BUY NOW

13822 WEST BOULTON BLVD. METTAWA, IL 60045

WWW.SHOPMEDVET.COM

Phone 800-544-7521

Fax 800-204-2177

ETHICON® SUTURE



Chromic/Plain Gut, Prolene, Ethilon & Silk

Chromic Gut Suture **BUY NOW**

Item#	Details	Needle	Qty	Price
634G-RL	5-0	FS-2	12/bx	\$92.49
635H-RL	4-0	FS-2	36/bx	\$247.21
G181H-RL	4-0	SH-1	36/bx	\$192.08
636H-RL	3-0	FS-2	36/bx	\$247.21
882H-RL	3-0	CT-2	36/bx	\$215.21
810H-RL	3-0	CT-1	36/bx	\$215.21
886H-RL	3-0	CP-2	36/bx	\$222.32
G182H-RL	3-0	SH-1	36/bx	\$215.21
892H-RL	3-0	CT-3/FN-2	36/bx	\$215.21
G122H-RL	3-0	SH	36/bx	\$215.21
G127H-RL	2-0	MH	36/bx	\$215.21
883H-RL	2-0	CT-2	36/bx	\$215.21
811H-RL	2-0	CT-1	36/bx	\$215.21
887H-RL	2-0	CP-2	36/bx	\$222.32
816H-RL	2-0	CP-1	36/bx	\$227.65
G123H-RL	2-0	SH	36/bx	\$215.21
802H-RL	0	CT	36/bx	\$215.21
888H-RL	0	CP-2	36/bx	\$222.32
817H-RL	0	CP-1	36/bx	\$227.65
884H-RL	0	CT-2	36/bx	\$215.21
812H-RL	0	CT-1	36/bx	\$215.21
G124H-RL	0	SH	36/bx	\$215.21
G128H-RL	0	MH	36/bx	\$215.21
803H-RL	1	CT	36/bx	\$215.21
885H-RL	1	CT-2	36/bx	\$215.21
813H-RL	1	CT-1	36/bx	\$215.21
865H-RL	1	CTX	36/bx	\$215.21
905H-RL	1	CTX	36/bx	\$218.76
814H-RL	2	CT-1	36/bx	\$215.21

Plain Gut Suture

Item#	Details	Needle	Qty	Price
H822H-RL	3-0	FS-2	36/bx	\$247.21

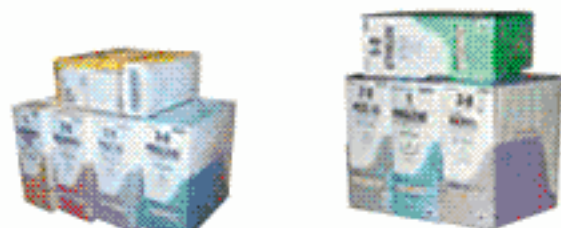

ETHICON® NEEDLE CHART

Prolene® Suture **BUY NOW**

Item#	Details	Needle	Qty	Price
8695G-RL	6-0	P-3	12/bx	\$145.85
8697G-RL	6-0	P-1	12/bx	\$145.85
8698G-RL	5-0	P-3	12/bx	\$145.85
8681G-RL	5-0	PS-3	12/bx	\$147.62
8661G-RL	5-0	FS-3	12/bx	\$71.15
8683G-RL	4-0	FS-2	12/bx	\$71.15
8699G-RL	4-0	P-3	12/bx	\$145.85
8665G-RL	3-0	FS-2	12/bx	\$67.59
8684G-RL	3-0	FS-1	12/bx	\$71.15
8685H-RL	2-0	FS	36/bx	\$198.45
8425H-RL	1	CT-1	36/bx	\$231.21
8424H-RL	0	CT-1	36/bx	\$231.21

Ethilon® Suture **BUY NOW**

Item#	Details	Needle	Qty	Price
1665G-RL	6-0	PS-3	12/bx	\$124.50
697G-RL	6-0	P-1	12/bx	\$124.50
698G-RL	5-0	P-3	12/bx	\$124.50
661H-RL	5-0	FS-2	36/bx	\$165.41
661G-RL	5-0	FS-2	12/bx	\$56.91
1667G-RL	4-0	PS-2	12/bx	\$124.50
662H-RL	4-0	FS-2	36/bx	\$165.41
662G-RL	4-0	FS-2	12/bx	\$56.91
627H-RL	3-0	KS	36/bx	\$184.97
663G-RL	3-0	FS-1	12/bx	\$56.91
663H-RL	3-0	FS-1	36/bx	\$165.41
669H-RL	3-0	FS-1	36/bx	\$165.41
628H-RL	2-0	KS	36/bx	\$184.97
664G-RL	2-0	FS	12/bx	\$56.91
664H-RL	2-0	FS	36/bx	\$165.41
830H-RL	1	CTX	36/bx	\$206.31

Silk Suture

Item#	Details	Needle	Qty	Price
640G-RL	5-0	P-3	12/bx	\$129.82
683G-RL	4-0	FS-2	12/bx	\$55.14
685G-RL	2-0	FS	12/bx	\$56.91

Ethicon suture subject to availability and price fluctuations. Call to confirm

1/2 CIRCLE TAPER POINT

Needle	Size	Needle	Size
CT-3	22mm	CTX	48mm
CT-2A	27mm	MH	36mm
CT-1	36mm	RB-1	17mm
CT	40mm	SH-1	22mm
		SH	26mm

STRAIGHT

Needle	Size
KS	60mm

REVERSE CUTTING

Needle	Size	Needle	Size
FS-2	19mm	FSL	30mm
FS-1	24mm	P-3	13mm
FS	26mm	P-1	11mm

1/2 CIRCLE REVERSE CUTTING

Needle	Size
CP-2	27mm
CP-1	36mm
X-1	23mm

13822 WEST BOULTON BLVD. METTAWA, IL 60045

WWW.SHOPMEDVET.COM

Phone 800-544-7521

Fax 800-204-2177

ETHICON® SUTURE



Monocryl, PDSII & Vicryl

Monocryl® Suture **BUY NOW**

Item#	Details	Needle	Qty	Price
Y922H-RL	4-0	FS-2	36/bx	\$232.98
Y923H-RL	3-0	FS-2	36/bx	\$232.98
Y316H-RL	3-0	SH	36/bx	\$195.63
Y338H-RL	3-0	CT-1	36/bx	\$197.41
Y344H-RL	3-0	CT-1	36/bx	\$231.21
Y942H-RL	3-0	FS-1	36/bx	\$227.65
Y317H-RL	2-0	SH	36/bx	\$195.63
Y339H-RL	2-0	CT-1	36/bx	\$197.41
Y345H-RL	2-0	CT-1	36/bx	\$231.21
Y943H-RL	2-0	FS-1	36/bx	\$227.65
Y334H-RL	0	CT-2	36/bx	\$195.63
Y340H-RL	0	CT-1	36/bx	\$197.41
Y346H-RL	0	CT-1	36/bx	\$231.21
Y341H-RL	1	CT-1	36/bx	\$197.41
Y347H-RL	1	CT-1	36/bx	\$231.21
Y353H-RL	1	CT	36/bx	\$199.20

PDS II® Suture **BUY NOW** Absorbable Suture undyed*

Item#	Details	Needle	Qty	Price
Z303H-RL	5-0	RB-1	36/bx	\$227.65
Z421H-RL*	5-0	FS-2	36/bx	\$266.77
Z463G-RL	5-0	P-3	12/bx	\$152.95
Z304H-RL	4-0	RB-1	36/bx	\$227.65
Z310H-RL	4-0	SH-1	36/bx	\$227.65
Z315H-RL	4-0	SH	36/bx	\$218.76
Z496G-RL*	4-0	PS-2	12/bx	\$152.95
Z397H-RL	4-0	FS-2	36/bx	\$236.55
Z422H-RL*	4-0	FS-2	36/bx	\$266.77
Z305H-RL	3-0	RB-1	36/bx	\$227.65
Z332H-RL	3-0	CT-2	36/bx	\$215.21
Z338H-RL	3-0	CT-1	36/bx	\$215.21
Z968H-RL	3-0	CP-2	36/bx	\$323.68
Z423H-RL*	3-0	FS-2	36/bx	\$266.77
Z442H-RL*	3-0	FS-1	36/bx	\$266.77
Z452H-RL	3-0	FS-1	36/bx	\$239.43
Z311H-RL	3-0	SH-1	36/bx	\$227.65
Z316H-RL	3-0	SH	36/bx	\$218.76
Z317H-RL	2-0	SH	36/bx	\$218.76
Z333H-RL	2-0	CT-2	36/bx	\$215.21
Z339H-RL	2-0	CT-1	36/bx	\$215.21
Z969H-RL	2-0	CP-2	36/bx	\$323.68
Z466H-RL	2-0	CP-1	36/bx	\$236.55
Z443H-RL*	2-0	FS-1	36/bx	\$266.77
Z451H-RL	2-0	FS-1	36/bx	\$239.43
Z334H-RL	0	CT-2	36/bx	\$215.21
Z340H-RL	0	CT-1	36/bx	\$215.21
Z970H-RL	0	CP-2	36/bx	\$323.68
Z467H-RL	0	CP-1	36/bx	\$236.55
Z341H-RL	1	CT-1	36/bx	\$215.21
Z468H-RL	1	CP-1	36/bx	\$236.55

BUY NOW

Vicryl® Suture **BUY NOW**

Absorbable Suture undyed*

Item#	Details	Needle	Qty	Price
J548G-RL	8-0	TG140-8, TG140-8	12/bx	\$499.77
J488G-RL*	7-0	P-1	12/bx	\$133.39
J489G-RL*	6-0	P-1	12/bx	\$133.39
J492G-RL*	6-0	P-3	12/bx	\$133.39
J493G-RL*	5-0	P-3	12/bx	\$133.39
J385H-RL	5-0	C-3	36/bx	\$229.43
J391H-RL	5-0	FS-2	36/bx	\$229.43
J422H-RL*	4-0	FS-2	36/bx	\$229.43
J392H-RL	4-0	FS-2	36/bx	\$229.43
J397H-RL	4-0	FS-2	36/bx	\$263.22
J494G-RL*	4-0	P-3	12/bx	\$133.39
J504G-RL*	4-0	P-2	12/bx	\$133.39
J310H-RL	4-0	SH-1	36/bx	\$190.30
J451H-RL	4-0	FS-1	36/bx	\$263.22
J311H-RL	3-0	SH-1	36/bx	\$190.30
J316H-RL	3-0	SH	36/bx	\$186.75
J416H-RL*	3-0	SH	36/bx	\$190.30
J327H-RL	3-0	CT-3	36/bx	\$190.30
J332H-RL	3-0	CT-2	36/bx	\$190.30
J338H-RL	3-0	CT-1	36/bx	\$190.30
J344H-RL	3-0	CT-1	36/bx	\$216.97
J393H-RL	3-0	FS-2	36/bx	\$229.43
J423H-RL*	3-0	FS-2	36/bx	\$229.43
J398H-RL	3-0	FS-2	36/bx	\$261.44
J442H-RL*	3-0	FS-1	36/bx	\$227.65
J452H-RL	3-0	FS-1	36/bx	\$263.22
J460H-RL	3-0	X-1	36/bx	\$229.43
J317H-RL	2-0	SH	36/bx	\$186.75
J328H-RL	2-0	CT-3	36/bx	\$190.30
J333H-RL	2-0	CT-2	36/bx	\$190.30
J339H-RL	2-0	CT-1	36/bx	\$190.30
J345H-RL	2-0	CT-1	36/bx	\$222.32
J466H-RL	2-0	CP-1	36/bx	\$193.86
J443H-RL*	2-0	FS-1	36/bx	\$227.65
J453H-RL	2-0	FS-1	36/bx	\$263.22
J461H-RL	2-0	X-1	36/bx	\$229.43
J334H-RL	0	CT-2	36/bx	\$190.30
J340H-RL	0	CT-1	36/bx	\$190.30
J346H-RL	0	CT-1	36/bx	\$222.32
J467H-RL	0	CP-1	36/bx	\$193.86
J341H-RL	1	CT-1	36/bx	\$190.30
J468H-RL	1	CP-1	36/bx	\$193.86
J195H-RL*	2	CP	36/bx	\$229.43

Ethicon suture subject to availability and price fluctuations, call to confirm

For Needle Chart Please See Previous Page

13822 WEST BOULTON BLVD. METTAWA, IL 60045

WWW.SHOPMEDVET.COM

Phone 800-544-7521

46

Fax 800-204-2177

Suture and Skin Closure

Braun® & Jorvet Suture



Suture Brand Comparison:

	Braun	Ethicon
Absorbable synthetic braided	Safil	Vicryl
Absorbable synthetic monofilament	Monosyn	PDS
Multi-filament nylon w/sheath	Braunamid	N/A

Needle-Suture Combinations by B. Braun.

Catgut Chromic.

1/2-Circle Round Bodied Needle.

HR22	75cm	3/0, 2/0
HR26	75cm	4/0, 3/0, 0, 1
HR30	75cm	3/0
HR37	75cm	3/0, 2/0, 0

1/2-Circle Reverse Cutting Needle.

HS26	75cm	3/0, 2/0
HS37s	75cm	2/0, 0

3/8-Circle Reverse Cutting Needle.

DS24	75cm	4/0, 3/0, 2/0, 0
DS30	75cm	2/0

Braunamid, Black.

3/8-Circle Reverse Cutting Needle.

DS24b	45cm	3/0
DS30b	45cm	3/0, 2/0, 0

1 x 12 Peel Packs.

Needle Comparison Chart.

Jorvet	Ethicon
HR26	SH
DS24	FS-1
DS19	FS-2
HS37S	CP-1
HR37	CT-1

Needle Comparison Chart.

Jorvet	Ethicon
HR22	CT-2
HR17	RB-1
HR30	—
DS16	—
DS30	CP-2
HS26	—
HS26s	—

Monosyn Violet

BUY NOW

Absorbable monofilament suture made of glyconate. Considered a mid-term suture in regard to absorption as it retains 50 percent of tensile strength up to 14 days. Exceptional knot security and knot tensile strength. Smooth monofilament for ease of passage through tissue.

- Braided suture "feel"
- Absorbed via hydrolysis
- Violet color for easy identification

Product Code	Details	Price
JORG22299	HS26, 2/0, 90cm L, 12 pk/box	\$78.00 /dz
JORG22456	HR37S, 2/0, 90cm L, 12 pk/box	\$72.00 /dz
JORG22445	HR37, 3/0, 90cm L, 12 pk/box	\$61.50 /dz
JORG22448	HR37, 1, 90cm L, 12 pk/box	\$66.00 /dz
JORG22486	HR26S, 2/0, 90cm L, 12 pk/box	\$61.50 /dz
JORG22824	HR26, 4/0, 90cm L, 12 pk/box	\$72.00 /dz
JORG22425	HR26, 3/0, 90cm L, 12 pk/box	\$61.50 /dz
JORG22426	HR26, 2/0, 90cm L, 12 pk/box	\$66.00 /dz
JORG22003	HR17-5/0, 90cm L, 12 pk/box	\$60.00 /dz
JORG22349	DS30-0, 90cm, 12 pk/box	\$66.00 /dz
JORG22225	DS24, 3/0, 90cm, 12 pk/box	\$58.50 /dz
JORG22226	DS24, 2/0, 90cm, 12 pk/box	\$61.50 /dz
JORG22904	DS19, 4/0, 90cm L, 12 pk/box	\$58.50 /dz
JORG22905	DS19, 3/0, 90cm L, 12 pk/box	\$48.00 /dz

When Ordering Specify: A B # # C

A = Needle Angle of Curvature:

H: 1/2-Circle OR D: 3/8-Circle

B = Body Type: R: Round-bodied or

S: Reverse cutting needle

= Needle Length:

Distance along the needle side between its point and its end, in millimeters.

C = Wire Size: S: Heavy body needle

Example: HR26 = 1/2-circle, round-bodied needle 26mm L.

Safil® Suture Jorvet

Safil® is a violet dyed precision-braided and coated synthetic suture made from pure polyglycolic acid.

- Easy handling
- Excellent knotting ability
- Secure knot tying
- High initial tensile strength
- Smooth passage through the tissue

Armed with a new generation of needles "Easyslide" Safil® is degraded by hydrolysis, providing predictable and reliable absorption. Safil maintains 50 percent of its initial tensile strength after 18 days and is fully absorbed after 90 days.

Product Code	Details	Price
JORG-48294	HS37S, 2/0, 12 pk/box	\$49.50/dz
JORG-48053	HR37, 1, 12pk/box	\$60.00/dz
JORG-48052	HR37, 0, 12pk/box	\$49.50/dz
JORG-48041	HR26, 3/0, 12pk/box	\$54.00/dz
JORG-48042	HR26, -2/0, 12pk/box	\$57.00/dz
JORG-48235	DS24, 2/0, 12pk/box	\$60.00/dz
JORG-48236	DS24, 2/0, 12pk/box	\$60.00/dz
JORG-48220	DS19, 4/0, 12pk/box	\$54.00/dz
JORG-48221	DS19, 3/0, 12pk/box	\$54.00/dz

Jorvet Safil Conversion Chart.

Jorvet/Safil#	Safil Needle & Suture Size	Vicryl#	Vicryl Needle
JG-48041	HR26-3/0	J316H	SH
JG-48042	HR26-2/0	J317H	SH
JG-48235	DS24-3/0	H452H	FS-1
JG-48236	DS24-2/0	H453H	FS-1
JG-48220	DS19-4/0	J-397H	FS-2
JG-48221	DS19-3/0	J-398H	FS-2
JG-48294	HS37S-2/0	J466H	CP-1
JG-48296	HS37S-0	J467H	CP-1
JG-48052	HR37-0	J340H	CT-1
JG-48053	HR37-1	J341H	CT-1

Ethicon/Dexon B/USSDG

Comparisons available upon request

Monosyn

BUY NOW

- Absorbable monofilament suture made of glyconate.
- Considered a mid-term suture in regard to absorption as it retains 50 percent of tensile strength up to 14 days.
- Exceptional knot security and knot tensile strength.

- Smooth monofilament for ease of passage through tissue.
- Braided suture "feel"
- Absorbed via hydrolysis
- Violet color for easy identification

Product Code	Details	Price
JORG22247	HS37S, 2/0, 12 pk/box	\$56.10 /dz
JORG22249	HS37S, 1, 12 pk/box	\$63.00 /dz
JORG22248	HS37S, 0, 12 pk/box	\$59.40 /dz
JORG22241	HS26S, 3/0, 12 pk/box	\$57.00 /dz
JORG22242	HS26S, 2/0, 12 pk/box	\$66.00 /dz
JORG22243	HS26S, 0, 12 pk/box	\$60.00 /dz
JORG22237	HS26, 0, 12 pk/box	\$63.00 /dz
JORG22048	HR37, 1, 12 pk/box	\$63.00 /dz
JORG22047	HR37, 0, 12 pk/box	\$61.50 /dz
JORG22035	HR30, 3/0, 70cm L, 12 pk/box	\$54.00 /dz

Product Code	Details	Price
JORG22036	HR30, 2/0, 12 pk/box	\$60.00 /dz
JORG22037	HR30, 0, 45cm L, 12 pk/box	\$69.00 /dz
JORG22024	HR26, 4/0, 12 pk/box	\$66.00 /dz
JORG22025	HR26, 3/0, 12 pk/box	\$66.00 /dz
JORG22027	HR26, 0, 12 pk/box	\$66.00 /dz
JORG22026	HR26, /0, 12 pk/box	\$63.00 /dz
JORG22231	DS30, 2/0, 12 pk/box	\$57.00 /dz
JORG22232	DS30, 0, 12 pk/box	\$57.00 /dz
JORG22217	DS24-, 0, 12 pk/box	\$50.00 /dz
JORG22215	DS24, 3/0, 12 pk/box	\$55.50 /dz

Product Code	Details	Price
JORG22216	DS24, 2/0, 12 pk/box	\$57.75 /dz
JORG-22217	DS24, 0, 70cm L, 12pk/box	\$50.00 /dz
JORG22204	DS19, 4/0, 12 pk/box	\$55.50 /dz
JORG22504	DS19, 4/0, 12 pk/box	\$54.00 /dz
JORG22205	DS19, -3/0, 12 pk/box	\$57.00 /dz
JORG22419	DS16, 5/0, 12 pk/box	\$54.00 /dz
JORG22220	DS16, 0, 12 pk/box	\$51.00 /dz



13822 WEST BOULTON BLVD. METTAWA, IL 60045

WWW.SHOPMEDVET.COM

Phone 800-544-7521

Fax 800-204-2177

Suture and Skin Closure

Jorvet Hemostatic Ligation Clips/Appliers

Jorvet Titanium Hemostatic Clip

Pure titanium annealed to a malleable consistency providing maximum vessel occlusion and zero memory to prevent tip opening after application. Biologically inert, radiolucent and non-magnetic for use with MRI or related scanning equipment.

Chevron shape provides progressive and encompassing tip-to-tip closure before complete and secure occlusion of tissue or vessel.

Diamond-shaped grooving and interlocking atraumatic teeth design of the clip ensures enhanced security in vessel closure. Striation is composed of small pyramidal heads, similar to tungsten inserts from needle-holders, insuring a firm, multidirectional, non-hurting vessel grip.

Triangular-shaped wire fits perfectly into the custom grooves of our applicators to provide mechanical power during application of the clip. Specially designed surface treatment and annealing provide a secure atraumaticity.

The exclusive small/medium size has been designed to match specific intermediary vessel sizes requested by surgeons. The cartridge is designed with effective clip retention, adhesive cartridge backing, and ergonomic design to insure precise and effortless clip loading.

JorVet BUY NOW

Cartridges						
Size	Color	Clip	Closed	Clip	Opened	Width
Small	Yellow	3.6mm	H	2.9mm	H	3.5mm W
Small/Med.	Lilac	4.6mm	H	4.1mm	H	4.5mm W
Medium	Blue	5.6mm	H	4.7mm	H	5.9mm W
Med./Large	Green	9mm	H	7.8mm	H	8.5mm W
Large	Orange	12.3mm	H	10.8mm	H	11.4mm W

Appliers						
Size	Color	15cm	19cm	28cm	28cm Right-Angled Jaws	
Small	Yellow	JOR796a	JOR796aL	--	--	
Small/Med.	Lilac	JOR796b	JOR796bL	--	--	
Medium	Blue	JOR796c	JOR796cL	--	--	
Med./Large	Green	JOR796d	JOR796dL	JOR796dLa		
Large	Orange	JOR796e	JOR796eL	JOR796eLa		

LigaFiba Braided Polyethylene Fiber (Material Only)

Monofilament nylon has been the standard suture material for the lateral suture technique for repair of CCL damage. Newer materials are made of braided polyethylene fiber and offer several advantages over nylon.

- Significantly stronger (up to 15 times)
- Better flex fatigue resistance and abrasion
- Knots tie easier This makes LigaFiba suture material an ideal material for ligament and tendon repair. Its available packages are:
- LigaFiba suture material only
- Provided with attached cruciate needle and straight needle
- LigaFiba with toggle buttons in bone tunnel procedures in both cruciate and hip repairs

JOR444A	150 lb test X 500mm length	\$15.00/ea
JOR444B	250lb Test x 600mm sterile	\$17.50/ea
JOR444C	500 lb test X 600mm length	\$20.00/ea

BUY NOW

NEW

Titanium Hemostatic Sterile Clips (Ligating Clips)

JOR795A	Small, 30 cartridges of 6 clips	\$102.75 /pk
JOR795B	Medium/Small, 30 cartridges of 6 clips	\$114.00 /pk
JOR795D	Medium/Large, 20 cartridges of 6 clips	\$114.00 /pk
JOR795C	Medium, 30 cartridges of 6 clips	\$114.00 /pk
JOR795E	Large, 20 cartridges of 6 clips	\$135.00 /pk

Titanium Hemostatic Sterile Clips (Appliers)

JOR796AL	Small clip applicator, Yellow, 19cm	\$99.50 /ea
JOR796A	Small Clip Applicator, Yellow, 15cm	\$99.50 /ea
JOR796BL	Medium/Small clip applicator, Lilac, 19cm	\$99.50 /ea
JOR796B	Medium/Small clip applicator, Lilac, 15cm	\$99.50 /ea
JOR796DLA	Medium/Large clip applicator, Green, angled 28cm, Right Angle	\$99.50 /ea
JOR796DL	Medium/Large clip applicator, Green, 28cm	\$99.50 /ea
JOR796D	Medium/Large clip applicator, Green, 19cm	\$99.50 /ea
JOR796CL	Medium clip applicator, Blue, 19cm	\$99.50 /ea
JOR796C	Medium clip applicator, Blue, 15cm	\$99.50 /ea
JOR796ELA	Large clip applicator, Orange, angled 28cm Right Angle	\$99.50 /ea
JOR796E	Large clip applicator, Orange, 19cm	\$99.50 /ea
JOR796EL	Large clip applicator, Green, 28cm	\$99.50 /ea

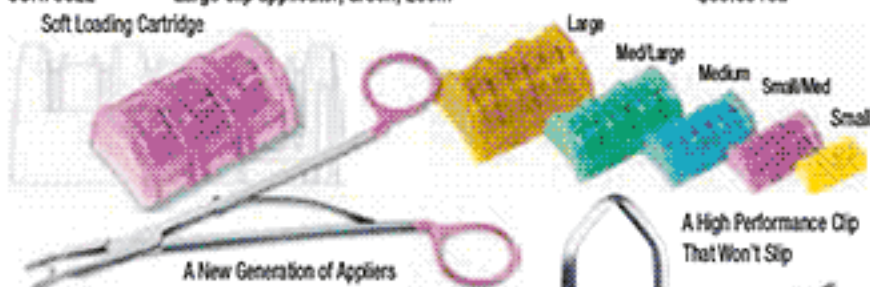

Michel Forceps

Can be used both for applying and removing Michel clips.

JOR886	Stainless steel, 12cm.	\$42.00/ea
--------	------------------------	------------

Michel Clips

JOR886A	7.5mm x 1.75mm, 100 clips/rack.	\$12.00/bx
JOR886C	18mm x 3mm, 100 clips/rack.	\$12.00/bx
JOR886B	14mm x 3mm, 100 clips/rack.	\$12.00/bx

LigaFiba ISO Toggle Suture

A newer technique for extra capsular repair of CCL damage uses a bone tunnel between iso metric point on the femur. A set of small toggles are used instead of passage through the fabella ligament. The LigaFiba is passed through the bone tunnel with an attached straight needle. Step by step guidelines available. The LigaFiba can be readily tied by the toggle button. Step by step guidelines available. The LigaFiba can be readily tied by the toggle button

JOR444F	250 lb test (dogs up to 50lbs) Bone tunnel use JOR372cx, 2.5mm drill	\$88.00 /ea
JOR444G	500 lb test (dogs over 50lbs) Bone tunnel use JOR372fx, 3.5mm drill	\$98.00 /ea



LigaFiba Lateral Suture

LigaFiba lateral suture with swaged on needles one end has attached cruciate needle for fabella ligament passage. The other end a straight needle for passing through tibial crest. The LigaFiba ties easily but also can be crimped (require JorVet fiber crimp instrument JOR710x) and JorVet fiber crimp JOR448a. Sterile package.

JOR444E	500lb w/needles	\$31.50 /ea
JOR444D	20lb w/needles	\$31.50 /ea

13822 WEST BOULTON BLVD. METTAWA, IL 60045

WWW.SHOPMEDVET.COM

Phone 800-544-7521

Fax 800-204-2177

Suture and Skin Closure

Skin Staplers

Oasis Skin Stapler

This skin stapler is affordable and simple. Its simplistic design and quality construction provides consistent and reliable performance. It fits comfortably in your hand to enhance control of skin closure and also reduces surgery time.

35 staples preloaded.

- Individually sterile packed in boxes of 6
- Lever action staplers are the most popular design on the market
- Distinctive staple shuttling feature greatly reduces track friction, a primary cause of jamming.
- Short trigger stroke for ease of use and nonstop feed.
- Handle design comfortably fits a wide range of hand sizes
- Angled head allows visibility of incision to ensure precise staple placement during operation.
- Arrow indicator assists in accurate staple alignment
- Staple count indicator allows you to view staples remaining to help minimize waste
- Quality construction and simple design assure reliable consistent performance.
- Staple lines are more likely to prevent leakage of blood or air.
- Regular staples measure 5.7mm x 3.8mm; Wide Staples measure 6.5mm x 4.7mm.

35R Regular, 5.4 x 3.6 mm after closure \$6.95/ea
35W Wide, 7mm x 4mm after closure \$6.95/ea



STERILE

BUY NOW

**TOP
SELLER**



(12+) \$5.95/ea

Premium German Skin Stapler

Quality German made sterile skin stapler containing 35 wide stainless steel (316 L) staples. Staple size 6.8 mm x 3.9 mm. The TOHAMED skin stapler saves time and money and closes wounds gently and securely. Due to its ergonomic design this appliance meets all expectations demanded from a reliable surgical device.

35W-GER Wide, 6.8 x 3.9 mm after closure \$7.95/ea



BUY NOW

Braun Manipler® AZ Suture Stapler

Braun/Aesculap. Newest development in surgical skin staplers. This is lightweight with a modern ergonomic design. This model is very popular in Europe.

- Type - wide
- 35 staples per staple handle
- Crown - 6.9mm
- Leg 3.6mm
- 6 staplers per box
- Sterile

JOR800M Crown 6.9mm, Leg 3.6mm, 6/box \$84.00 /pk



Surgiclose Skin Stapler

Wound closure with the most economical external stapler just became easier. Over 80 percent of all human surgical wound closures involve the use of skin staplers. In veterinary surgery, less than 10 percent of surgeries utilize skin staplers. Why is there such a wide difference in usage? The use of skin staplers has been limited in veterinary surgery due to the high cost of disposable human skin staplers. The use of sutures with needle packs has been less expensive to close the skin (average cost ranges \$4-\$5). The introduction of the SurgiClose stapling system addresses the specific needs of the veterinary surgeon. Benefits:

- Better apposition of skin edges with better cosmetic results.
- Less reactivity of stainless steel staples
- Significantly faster wound closure
- Ease of learning proper technique.

Features:

- 20-pack staple cartridges cost less than a pack of needle suture, and is a huge savings over conventional throw away skin staples
- Both handle and staples are provided sterile
- Staple cartridges are inserted into the handle and are specially designed to reduce jamming
- Handle can be autoclaved for repeated use
- 20-staple cartridge sufficiently closes a 4"-5" incision
- Closed staple shaped squarely, restricting movement or rolling of a staple

SC0 Series

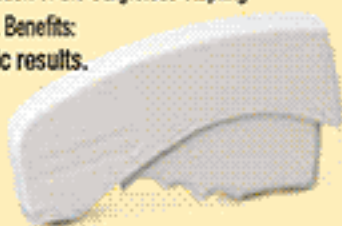

BUY NOW

SC01H Non-Sterile, Low Temp Autoclavable \$15.75 /ea
SC03H High Temp Autoclavable \$14.95 /ea
SC36C 6 Cartridges, 20 Staples Each \$40.47/ea



Surgi-Close (Staple Handle)

Staple handle requires cleaning and sterilizing between uses, but there is no longer the need to lubricate the former between uses. Each staple is lubricated with a coating of USP Sodium Stearate for easy penetration, reducing forming force and release from the former. Staple handle packaged in sterile pouch from a dispensing box.

JOR799 Sterile, 6pk \$87.00 /pk

Surgi-Close Stapler (Staples)

Staples are now lubricated with USP Sodium Stearate to promote easier forming taking less force and quicker release without the necessity to lubricate the handle between uses. This takes the hassle out of using cost effective stapling for wound closure. Staples are packaged in a sterile pouch from a dispensing box.

JOR800 20/pk Cartridge, 36 Cartridges/box. \$224.00 /ea
JOR800X 24 cartridges of 20 staples \$140.00 /ea



Surgi-Close (Staple Removal Forceps)

JOR799R Staple Removal Forceps will work with any brand of skin staple. \$6.30 /ea

Surgi-Close Starter Kit

JOR799R

- Starter Kit. Includes:
- 6 cartridges of 20 staples
 - 1 stapler handle
 - Staple removal forceps

JOR800S \$87.00 /ea



BUY NOW



Oasis Disposable Skin Staple Remover

STAPLEREM Sterile, Single Use \$1.95 /ea



13822 WEST BOULTON BLVD. METTAWA, IL 60045

WWW.SHOPMEDVET.COM

Phone 800-544-7521

Fax 800-204-2177

Suture and Skin Closure

Tissue Adhesive & Suture Removal

TISSUE ADHESIVE



Veterinary use only. Tissue Adhesive monomeric formulation that forms a thin, waterproof adhesion.

- Polymerizes in 5 seconds
- Designed for De-claw Procedures & Skin Closure
- Comes with 5 Sterile applicators
- 3g, Color Blue



\$10.99/ea

Item# TA5

TA5 5 Sec Vet Use 3g Btl \$10.99 /ea

BUY NOW



Oasis Liquivet Tissue Adhesive



- LiquiVet monomeric formulation that forms a thin, waterproof adhesion.
- LiquiVet comes in larger bottles compared to other tissue adhesives. 3g dispensing bottle with 5 sterile applicators.
- Veterinary use only. LiquiVet monomeric formulation that forms a thin, waterproof adhesion to bond tissue in a variety of vet procedures. Comes in 3g dispensing bottles with 5 applicators.

Item# VG3

- Polymerizes in 2 seconds
- De-claw procedures
- 3g

Item# VG3SC

- Polymerizes in 8 seconds
- Skin Closure
- 3g

\$10.95/ea

Vet use only.

VG3 2 Second Vet Use 3g Btl \$10.95/ea
VG3SC 8 Second Vet Use 3g Btl \$10.95/ea



BUY NOW

Jorvet Umbilical Tape

Braided Polyester Tape In Plastic Bottles

JOR25UA Non-Sterile, 1/8" x 20 yds. \$10.10 /ea
JOR25UC Non-Sterile, 1/4" x 20 yds. \$12.30 /ea
JOR25UB Non-Sterile, 3/8" x 20 yds. \$13.80 /ea



Jorvet Suture Wire

Suture Wire Stainless Steel

MIL9-40-36 .005 Diam., 13mm, 1oz, Spool \$18.56/ea



Suture Removal Kit

Sterile Suture Removal Tray Includes:

- Metal Littauer Scissors
- Deluxe Suture Forceps
- Gauze Pad

SUTURE-REM Tray \$1.99/ea



BUY NOW

Needle Sterilization Rack

MIL3-50 Rack \$29.62/ea



Needle Rack

Jorvet

Convenient spring action model for holding suture needles.

JOR105R \$15.00/ea



Bone Wax

Allows the effective control of bleeding from bone surfaces.

BW25 2.5Gm Sterile Each \$5.95/ea



Suture Kits

Jorvet

JOR91KA Equine, Size 0 Braunamid with #2 3/8 reverse cut suture needle \$4.80/ea
JOR91KB Bovine, #3 Braunamid suture with XL 3/8 reverse cut needle \$5.40/ea
JOR91KC Small Animal, Size 0 Braunamid with #8 3/8 reverse cut suture needle \$4.80/ea
JOR91KD Calves and Pigs, Braunimid 60" long with size 2 needle, 3/8 reverse cut \$5.40/ea

DA Suture Needles

BUY NOW

JOR110A Tapered 8" curve tip to tip \$31.50/ea
JOR110B Reverse cutting, curved, 8" \$31.50/ea

Double-Curved Suture Needles

JOR110SL Large, 5", 12/pk. \$18.00/dz
JOR110SM Medium, 3 1/2", 12/pk. \$18.00/dz

JOR110SM

Jorvet **BUY NOW**

Heavy Duty Suture-Needles Half Curved

Heavy duty 1/2 circle needles. Stainless steel cutting edge.

JOR110HC3 Size 3", 12/pk. \$19.50/pk
JOR110HC4 Size 4", 12/pk. \$19.50/pk
JOR110HC5 Size 5", 12/pk. \$19.50/pk
JOR110HC6 Size 6", 12/pk. \$19.50/pk

Jorvet



13822 WEST BOULTON BLVD. METTAWA, IL 60045

Phone 800-544-7521

50

WWW.SHOPMEDVET.COM

Fax 800-204-2177

Suture and Skin Closure

Anchor, Jorvet & Miltex Suture Needles



Introducing.. anchor SUTURE NEEDLES



TO SEE OUR FULL SELECTION OF anchor SUTURE NEEDLES VISIT OUR WEBSITE WWW.SHOPMEDVET.COM

anchor (3/8 Circle Reverse Cutting Edge)

Item#	Details	Price
1822-10R	Size: 10, Non-Sterile, 12/pk,	\$15.60
1822-12R	Size: 12, Non-Sterile, 12/pk,	\$15.60
1822-14R	Size: 14, Non-Sterile, 12/pk,	\$15.60
1822-16R	Size: 16, Non-Sterile, 12/pk,	\$15.60
1822-18R	Size: 18 Non-Sterile, 12/pk,	\$15.60
1822-20R	Size: 20, Non-Sterile, 12/pk,	\$15.60

anchor (1/2 Circle Reverse Cutting Edge)

Item#	Details	Price
1834-3R	Size: 3 (Equivalent to Surgical Size 10), Non-Sterile, 12/pk	\$15.60
1834-5R	Size: 5 (Equivalent to Surgical Size 12-13), Non-Sterile, 12/pk	\$15.60
1834-6R	Size: 6 (Equivalent to Surgical Size 14-15), Non-Sterile, 12/pk	\$15.60
1834-7R	Size: 7 (Equivalent to Surgical Size 16-17), Non-Sterile, 12/pk	\$15.60
1834-8R	Size: 8 (Equivalent to Surgical Size 18-19), Non-Sterile, 12/pk	\$15.60
1834-9R	Size: 9 (Equivalent to Surgical Size 20), Non-Sterile, 12/pk	\$15.60

BUY NOW

anchor (1/2 Circle Taper Point Round Body)

Item#	Details	Price
1842-10R	Size: 10, Non-Sterile, 12/pk	\$15.60
1842-12R	Size: 12, Non-Sterile, 12/pk	\$15.60
1842-14R	Size: 14, Non-Sterile, 12/pk	\$15.60
1842-16R	Size: 16, Non-Sterile, 12/pk	\$15.60
1842-18R	Size: 18, Non-Sterile, 12/pk	\$15.60
1842-20R	Size: 20, Non-Sterile, 12/pk	\$15.60

1822 3/8 Circle Reverse Cutting



1842 1/2 Circle Taper Point



1834 1/2 Circle Reverse Cutting



NEW

BUY NOW

Jorvet Reverse Cutting Suture Needles

Choose from a full selection of needles for all veterinary needs. Sizes available include 2, 4, 6, 8, 10, 11, 12, 13, 14, 16, 18 and 20 in 3/8-circle & 1/2 Reverse Circle models. 12/pk. Price is for (1) 12/PK OF ONE size only, Please specify size when ordering.

3/8" Circle		1/2" Circle	
JOR7011-2	size 2, 55mm \$9.30/dz	JOR7031-2	size 2, 45mm \$9.30/dz
JOR7011-4	size 4, 49mm \$9.30/dz	JOR7031-4	size 4, 45mm \$9.30/dz
JOR7011-6	size 6, 43mm \$9.30/dz	JOR7031-6	size 6, 35mm \$9.30/dz
JOR7011-8	size 8, 39mm \$6.30/dz	JOR7031-8	size 8, 29mm \$9.30/dz
JOR7011-10	size 10, 33mm \$9.30/dz	JOR7031-10	size 10, 26mm \$9.30/dz
JOR7011-11	size 11, 31mm \$9.30/dz	JOR7031-12	size 12, 23mm \$9.30/dz
JOR7011-12	size 12, 28mm \$9.30/dz	JOR7031-14	size 14, 19mm \$9.30/dz
JOR7011-14	size 14, 25mm \$9.30/dz	JOR7031-16	size 16, 17mm \$9.30/dz
JOR7011-16	size 16, 22mm \$9.30/dz	JOR7031-18	size 18, 15mm \$9.30/dz
JOR7011-18	size 18, 20mm \$9.30/dz	JOR7031-20	size 20, 13mm \$9.30/dz
JOR7011-20	size 20, 17mm \$9.30/dz		

Jorvet Taper Suture Needles

Choose from a full selection of needles for all veterinary needs. Sizes available include 2, 4, 6, 8, 10, 11, 12, 13, 14, 16, 18 and 20 in 3/8- & 1/2 Taper Circle. Models 12/pk. Price is for (1) 12/PK OF ONE size only, Please specify size when ordering.

3/8" Circle		1/2" Circle	
JOR6017-2	size 2, 55mm \$9.30/dz	JOR6037-2	size 2, 45mm \$9.30/dz
JOR6017-4	size 4, 49mm \$9.30/dz	JOR6037-4	size 4, 40mm \$9.30/dz
JOR6017-6	size 6, 22mm \$9.30/dz	JOR6037-6	size 6, 35mm \$9.30/dz
JOR6017-8	size 8, 39mm \$9.30/dz	JOR6037-8	size 8, 29mm \$9.30/dz
JOR6017-10	size 10, 33mm \$9.30/dz	JOR6037-10	size 10, 26mm \$9.30/dz
JOR6017-12	size 12, 28mm \$9.30/dz	JOR6037-12	size 12, 23mm \$9.30/dz
JOR6017-14	size 14, 25mm \$9.30/dz	JOR6037-14	size 19, 25mm \$9.30/dz
JOR6017-16	size 16, 22mm \$9.30/dz	JOR6037-16	size 16, 17mm \$9.30/dz
JOR6017-18	size 18, 20mm \$9.30/dz	JOR6037-18	size 18, 13mm \$9.30/dz
JOR6017-20	size 20, 17mm \$9.30/dz	JOR6037-20	size 20, 13mm \$9.30/dz

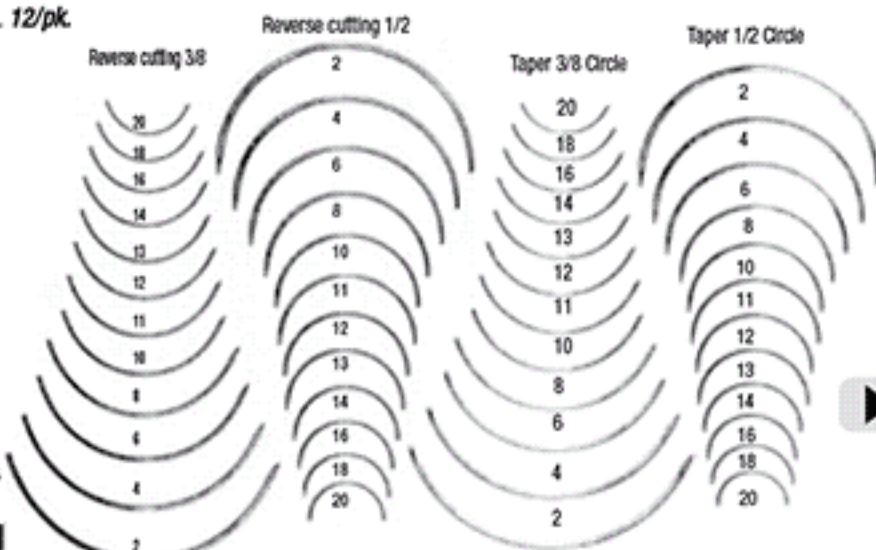

Jorvet

JOR7031XL 3/8-circle, 3 1/4". Extra heavy needles for bovine and equine use. 12/pk. \$36.00/pk
 JOR6037XL 3/8-circle, 3 1/4". Extra heavy needles for bovine and equine use. 12/pk. \$30.00/pk



12 of one size only. Please specify size when ordering.

Miltex Regular Surgeon's Needles

Miltex 1/2 Circle Taper Point Needle

MIL-192A-10	Size 10, 35mm, 12/pk	\$47.04/Pk
MIL-192A-12	Size 12, 29mm, 12/pk	\$47.04/Pk
MIL-192A-14	Size 14, 24mm, 12/pk	\$47.04/Pk
MIL-192A-16	Size 16, 22mm, 12/pk	\$47.04/Pk
MIL-192A-18	Size 18, 18mm, 12/pk	\$47.04/Pk
MIL-192A-20	Size 20, 13mm, 12/pk	\$47.04/Pk

Miltex 1/2 Circle Cutting Edge Needle

MIL-192-10	Size 10, 35mm, 12/pk	\$50.96/Pk
MIL-192-12	Size 12, 29mm, 12/pk	\$50.96/Pk
MIL-192-14	Size 14, 24mm, 12/pk	\$50.96/Pk
MIL-192-16	Size 16, 22mm, 12/pk	\$50.96/Pk
MIL-192-18	Size 18, 18mm, 12/pk	\$50.96/Pk
MIL-192-20	Size 20, 13mm, 12/pk	\$50.96/Pk



Miltex 3/8 Circle Cutting Edge Needle

MIL-140-10	Size 10, 35mm, 12/pk	\$41.16/Pk
MIL-140-12	Size 12, 29mm, 12/pk	\$41.16/Pk
MIL-140-14	Size 14, 24mm, 12/pk	\$41.16/Pk
MIL-140-16	Size 16, 22mm, 12/pk	\$41.16/Pk
MIL-140-18	Size 18, 18mm, 12/pk	\$41.16/Pk
MIL-140-20	Size 20, 13mm, 12/pk	\$41.16/Pk

Miltex 3/8 Circle Taper Point Needle

MIL-140A-10	Size 10, 35mm, 12/pk	\$47.04/Pk
MIL-140A-12	Size 12, 29mm, 12/pk	\$47.04/Pk
MIL-140A-14	Size 14, 24mm, 12/pk	\$47.04/Pk
MIL-140A-16	Size 16, 22mm, 12/pk	\$47.04/Pk
MIL-140A-18	Size 18, 18mm, 12/pk	\$47.04/Pk
MIL-140A-20	Size 20, 13mm, 12/pk	\$47.04/Pk



BUY NOW

SINGLE SUTURE CLOSEOUT

SUBJECT TO AVAILABILITY • USUALLY LESS THAN 24 MONTHS DATING

MONOFILAMENT SYNTHETIC ABSORBABLE

(PDS, Monocryl, Biosyn, Maxon, Caprosyn, PDO) No Choice of Type or Brand.

\$200

ITEM#	DESCRIPTION	BUY NOW
MSA-0-T	Size 0 with Taper Needle	(no choice of needle size)
MSA-1-T	Size 1 with Taper Needle	(no choice of needle size)
MSA-2-0-T	Size 2-0 with Taper Needle	(no choice of needle size)
MSA-3-0-T	Size 3-0 with Taper Needle	(no choice of needle size)
MSA-4-0-T	Size 4-0 with Taper Needle	(no choice of needle size)

\$250

MSA-0-C	Size 0 with Cutting Needle	(no choice of needle size)
MSA-1-C	Size 1 with Cutting Needle	(no choice of needle size)
MSA-2-0-C	Size 2-0 with Cutting Needle	(no choice of needle size)
MSA-3-0-C	Size 3-0 with Cutting Needle	(no choice of needle size)
MSA-4-0-C	Size 4-0 with Cutting Needle	(no choice of needle size)

MONOFILAMENT NON-ABSORBABLE

(Nylon, Polypropylene) No Choice of Type or Brand.

\$100

ITEM#	DESCRIPTION	BUY NOW
MN-1-T	Size 1 with Taper Needle	(no choice of needle size)
MN-1-C	Size 1 with Cutting Needle	(no choice of needle size)
MN-0-T	Size 0 with Taper Needle	(no choice of needle size)
MN-0-C	Size 0 with Cutting Needle	(no choice of needle size)
MN-2-0-T	Size 2-0 with Taper Needle	(no choice of needle size)
MN-2-0-C	Size 2-0 with Cutting Needle	(no choice of needle size)
MN-3-0-T	Size 3-0 with Taper Needle	(no choice of needle size)
MN-3-0-C	Size 3-0 with Cutting Needle	(no choice of needle size)
MN-4-0-C	Size 4-0 with Cutting Needle	(no choice of needle size)

\$200

MN-5-0-T	Size 5-0 with Taper Needle	(no choice of needle size)
MN-5-0-C	Size 5-0 with Cutting Needle	(no choice of needle size)
MN-6-0-C	Size 6-0 with Cutting Needle	(no choice of needle size)
MN-6-0-T	Size 6-0 with Taper Needle	(no choice of needle size)

BRAIDED NON-ABSORBABLE

(Mixed Silk, Ethibond, Surgidac, Ti-Cron, Mersilene, Sofsilik, etc.) No Choice of Type or Brand.

\$100

ITEM#	DESCRIPTION	BUY NOW
BRAD-2-0-C	Size 2-0 with Cutting Needle	no choice of needle size)
BRAD-3-0-C	Size 3-0 with Cutting Needle	no choice of needle size)
BRAD-4-0-C	Size 4-0 with Cutting Needle	(no choice of needle size)
BRAD-5-0-C	Size 5-0 with Cutting Needle	(no choice of needle size)

We have outdated suture available in their original packaging. Great for teaching or research. We sell them as non-sterile and for veterinary use only. Inquire for type, specific sizes and pricing. Letter of acknowledgement is required.

13822 WEST BOULTON BLVD. METTAWA, IL 60045

WWW.SHOPMEDVET.COM

Phone 800-544-7521

52

Fax 800-204-2177

SINGLE SUTURE CLOSEOUT

SUBJECT TO AVAILABILITY • USUALLY LESS THAN 24 MONTHS DATING

SYNTHETIC ABSORBABLE

(Mixed Vicryl, Polysorb, PDS, PGA, PDO, Monocryl, Biosyn, Maxon, Dexon) No Choice of Type or Brand.

\$1.50

ITEM#	DESCRIPTION
SA-1-T	Size 1 with Taper Needle (no choice of needle size)
SA-0-T	Size 0 with Taper Needle (no choice of needle size)
SA-2-0-T	Size 2-0 with Taper Needle (no choice of needle size)
SA-3-0-T	Size 3-0 with Taper Needle (no choice of needle size)
SA-4-0-T	Size 4-0 with Taper Needle (no choice of needle size)

\$1.75

ITEM#	DESCRIPTION	BUY NOW
SA-1-C	Size 1 with Cutting Needle	(no choice of needle size)
SA-0-C	Size 0 with Cutting Needle	(no choice of needle size)
SA-2-0-C	Size 2-0 with Cutting Needle	(no choice of needle size)
SA-3-0-C	Size 3-0 with Cutting Needle	(no choice of needle size)
SA-4-0-C	Size 4-0 with Cutting Needle	(no choice of needle size)

GUT ABSORBABLE

(Mixed Chromic & Plain Gut) No Choice of Type or Brand.

50¢

ITEM#	DESCRIPTION	BUY NOW
GA-1-NO	Size 1 with No Needle	(no choice of needle size)
GA-0-NO	Size 0 with No Needle	(no choice of needle size)
GA-2-0-NO	Size 2-0 with No Needle	(no choice of needle size)
GA-3-0-NO	Size 3-0 with No Needle	(no choice of needle size)
GA-4-0-NO	Size 4-0 with No Needle	(no choice of needle size)

\$1.00

Taper Needle

ITEM#	DESCRIPTION
GA-1-T	Size 1 with Taper Needle (no choice of needle size)
GA-0-T	Size 0 with Taper Needle (no choice of needle size)
GA-2-0-T	Size 2-0 with Taper Needle (no choice of needle size)
GA-3-0-T	Size 3-0 with Taper Needle (no choice of needle size)
GA-4-0-T	Size 4-0 with Taper Needle (no choice of needle size)

Cutting Needle

ITEM#	DESCRIPTION
GA-0-C	Size 0 with Cutting Needle (no choice of needle size)
GA-2-0-C	Size 2-0 with Cutting Needle (no choice of needle size)
GA-3-0-C	Size 3-0 with Cutting Needle (no choice of needle size)
GA-4-0-C	Size 4-0 with Cutting Needle (no choice of needle size)

\$2.00

ITEM#	DESCRIPTION
Cutting Needle	
GA-5-0-C	Size 5-0 with Cutting Needle (no choice of needle size)
Taper Needle	
GA-5-0-T	Size 5-0 with Taper Needle (no choice of needle size)

We have outdated suture available in their original packaging. Great for teaching or research. We sell them as non-sterile and for veterinary use only. Inquire for type, specific sizes and pricing. Letter of acknowledgement is required.

13822 WEST BOULTON BLVD. METTAWA, IL 60045

WWW.SHOPMEDVET.COM

Phone 800-544-7521

53

Fax 800-204-2177

Syringes & Needles



Disposable Syringes & Needles



MVI Insulin & T.B. Syringe

MV1CCLS	1cc L/S, Syring only, 100/bx	\$7.99/bx	10+\$8.99ea	20+\$5.99ea
---------	------------------------------	-----------	-------------	-------------

MVI Insulin & T.B. Syringe & Needle

MV1CC25X5/8	1cc 25g x 5/8", T.B. 100/bx	\$8.99/bx	10+\$7.99ea	20+\$6.99ea
MV1CC27X1/2	1cc 27g x 1/2", T.B. 100/bx	\$8.99/bx	10+\$7.99ea	20+\$6.99ea
MV1CCINS	1cc 29g x 1/2", insulin 100/bx	\$8.99/bx	10+\$7.99ea	20+\$6.99ea



MVI Syringes

MV3CCLL	3cc L/L 100/bx	\$6.99/bx	10+\$5.99ea	20+\$4.99ea
MV3CCLS	3cc L/S 100/bx	\$6.99/bx	10+\$5.99ea	20+\$4.99ea
MV5CCLL	5cc L/L 100/bx	\$8.99/bx	10+\$7.99ea	20+\$6.99ea
MV5CCLS	5cc L/S 100/bx	\$8.99/bx	10+\$7.99ea	20+\$6.99ea
MV10CCLL	10cc L/L 100/bx	\$10.99/bx		
MV10CCLS	10cc L/S 100/bx	\$10.99/bx		
MV20CCELS	20cc Eccentric Luer Slip 50/bx	\$14.95/bx		
MV20CCLL	20cc L/L 50/bx	\$14.95/bx		
MV30CCELS	30cc Eccentric Luer Slip 30/bx	\$9.99/bx		
MV30CCLL	30cc L/L 30/bx	\$9.99/bx		
MV60CCCT	60cc Catheter Tip 25/bx	\$9.99/bx	10+\$8.99ea	20+\$7.99ea
MV60CCELS	60cc Eccentric Luer Slip 25/bx	\$9.99/bx	10+\$8.99ea	20+\$7.99ea
MV60CCLL	60cc L/L 25/bx	\$9.99/bx	10+\$8.99ea	20+\$7.99ea

- Sharp Siliconized Needle
- Individual Soft Pack
- Bold Graduation
- Latex Free
- ISO-9002, CE
- FDA registered



MVI Syringe & Needle

MV3CC20X1L	3cc 20g x 1", L/L 100/bx	\$6.99/bx	10+\$5.99ea	20+\$4.99ea
MV3CC20X1.5L	3cc 20g x 1 1/2", L/L 100/bx	\$6.99/bx	10+\$5.99ea	20+\$4.99ea
MV3CC21X1L	3cc 21g x 1", L/L 100/bx	\$6.99/bx	10+\$5.99ea	20+\$4.99ea
MV3CC22X3/4L	3cc 22g x 3/4", L/L 100/bx	\$6.99/bx	10+\$5.99ea	20+\$4.99ea
MV3CC22X1L	3cc 22g x 1", L/L 100/bx	\$6.99/bx	10+\$5.99ea	20+\$4.99ea
MV3CC22X1.5L	3cc 22g x 1 1/2", L/L 100/bx	\$6.99/bx	10+\$5.99ea	20+\$4.99ea
MV3CC22X3/4S	3cc 22g x 3/4", L/S 100/bx	\$6.99/bx	10+\$5.99ea	20+\$4.99ea
MV3CC23X1L	3cc 23g x 1", L/L 100/bx	\$6.99/bx	10+\$5.99ea	20+\$4.99ea
MV3CC25X5/8L	3cc 25g x 5/8", L/L 100/bx	\$6.99/bx	10+\$5.99ea	20+\$4.99ea
MV3CC25X1.25L	3cc 25g x 1.25", L/L 100/bx	\$6.99/bx	10+\$5.99ea	20+\$4.99ea
MV3CC27X1.25L	3cc 27g x 1.25", L/L 100/bx	\$6.99/bx	10+\$5.99ea	20+\$4.99ea



MVI Polyhub Needles

MVN18X1	18 x 1, 100/bx	\$3.99/bx	10+\$3.49ea	20+\$2.99ea
MVN18X1.5	18 x 1 1/2, 100/bx	\$3.99/bx	10+\$3.49ea	20+\$2.99ea
MVN20X1	20 x 1, 100/bx	\$3.99/bx	10+\$3.49ea	20+\$2.99ea
MVN20X1.5	20 x 1 1/2, 100/bx	\$3.99/bx	10+\$3.49ea	20+\$2.99ea
MVN22X1	22 x 1, 100/bx	\$3.99/bx	10+\$3.49ea	20+\$2.99ea
MVN22X1.5	22 x 1, 1/2 100/bx	\$3.99/bx	10+\$3.49ea	20+\$2.99ea
MVN22X3/4	22 x 3/4, 100/bx	\$3.99/bx	10+\$3.49ea	20+\$2.99ea
MVN23X1	23 x 1, 100/bx	\$3.99/bx	10+\$3.49ea	20+\$2.99ea
MVN25X1	25 x 1, 100/bx	\$3.99/bx	10+\$3.49ea	20+\$2.99ea
MVN25X1.5	25 x 1 1/2, 100/bx	\$3.99/bx	10+\$3.49ea	20+\$2.99ea
MVN25X5/8	25 x 5/8, 100/bx	\$3.99/bx	10+\$3.49ea	20+\$2.99ea

CLICK HERE TO



BUY NOW

MONOJECT® BLOWOUT

FOR A LIMITED TIME WHILE SUPPLIES LAST!!!

MONOJECT® SYRINGES

Soft pack Syringes

125058	1cc T.B. 25g x 5/8", 100/bx	\$16.50
300555	3cc L/S 100/BX	\$9.95
300777	3cc LL 100/BX	\$9.95
600777	6cc L/L 100/BX	\$17.85
600555	6cc L/S 100/BX	\$17.85
200555	12cc L/S 80/BX	\$13.50
200777	12cc L/L 80/BX	\$12.95
2000777	20cc L/L 40/BX	\$20.25
2000555	20cc L/S 40/BX	\$20.25
3500555	35cc L/S 40/BX	\$22.00
3500777	35cc L/L 40/BX	\$22.00
6000555	60cc L/S 30/BX	\$23.25
6000777	60cc L/L 30/BX	\$23.25

Combo Soft Packs

127012	1CC 27X1/2, T.B., 100/BX	\$14.95
320100	3cc 20G X 1", 100/BX	\$16.65
320112	3cc 20G X 1.5", 100/BX	\$16.65
321100	3cc 21G X 1", 100/BX	\$16.65
321112	3cc 21 X 1 1/2, 100/BX	\$16.65
322100	3cc 22G X 1", 100/BX	\$16.65
322112	3cc 22G X 1.5", 100/BX	\$16.65

Combo Soft Packs

323100	3cc 23G X 1", 100/BX	\$16.65
325058	3cc 25G X 5/8", 100/BX	\$16.65
325100	3 CC 25 X 1, L/L, 100/BX	\$16.65
325114	3cc 25G X 1 1/4", L/L, 100/BX	\$16.65
327114	3cc 27G X 1 1/4", L/L, 100/BX	\$16.65
622112	6cc 22G X 1.5", 100/BX	\$23.20
621100	6CC 21 X 1", 100/BX	\$25.70

1/2cc & 1cc Hard Pack Syringes

500014	1/2cc, 28G X 1/2", INSULIN 100/BX	\$14.95
501178	1cc, 26G X 3/8", T.B., 100/bx	\$14.95
501442	1cc 27 X 1/2 U-40/U-80 INSULIN 100/BX	\$9.95

3cc Hard Pack Syringes

511201	1cc, 28G X 1/2, " , TB, 100/BX	\$14.95
513025	3cc, 20G X 3/4", 100/BX	\$10.95
513025	3cc, 20G X 3/4", 100/BX	\$10.95
513330	3cc, 23G X 1", 100/BX	\$10.95

Monoject Syringes Hard Pack

535762	35cc, L/L, 30/BX	\$17.95
520657	20cc L/L 50/BX	\$19.95
560125	60cc L/L 20/BX	\$17.95
560141	60cc, C/T, 20/BX	\$17.95
560224	60cc, L/S, 20/BX	\$17.95

- One step peel-away package for quick/easy opening
- Convenient, individually packaged inner cartons.
- Brilliant color-coded needle gauge stripe
- New and improved needle lubricant
- Clear barrel construction and bolder
- 3cc syringe features extended finger flanges and a longer plunger rod for greater control
- New syringe tip caps included on each syringe.

MONOJECT® & Magellan® are registered trademarks of Covidien



BUY NOW

Hurry, When They're Gone They're Gone!

13822 WEST BOULTON BLVD. METTAWA, IL 60045

WWW.SHOPMEDVET.COM

Phone 800-544-7521

55

Fax 800-204-2177

MONOJECT® BLOWOUT

FOR A LIMITED TIME WHILE SUPPLIES LAST!!!

MONOJECT® SAFETY SYRINGES & NEEDLES

Safety Syringes

533908	3cc, L/L, 100/BX	\$14.95
522018	12cc, 20G X 1 1/2", 50/BX	\$14.95
522026	12cc, 21G X 1 1/2", 50/BX	\$14.95

Safety Syringe with Needle Combos

533056	3cc, 20G X 1 1/2", 50/BX	\$14.95
533130	3cc, 21G X 1", 100/BX	\$14.95
533155	3cc, 21G X 1 1/2", 100/BX	\$14.95
533908	3CC L/L, SAFETY, 100/BX	\$14.95

MONOJECT® Magellan® Safety Syringe & Needle Combos

833015	3cc, 20G X 1 1/2", 50/BX	\$4.95
833110	3cc, 21G X 1", 50/BX	\$4.95
833215	3cc, 22G X 1 1/2", 50/BX	\$4.95
833510	3cc, 25G X 1", 50/BX	\$4.95
833558	3cc, 25 X 5/8, 50/BX	\$19.95

WHILE SUPPLIES LASTS

Magellan Safety Needles

850815	18g X 1 1/2", 50/BX	\$2.95
850910	19g X 1", 50/BX	\$2.95
850915	19g X 1 1/2", 50/BX	\$2.95
850015	20g X 1 1/2", 50/BX	\$2.95
850110	21g X 1", 50/BX	\$2.95
850115	21g X 1 1/2", 50/BX	\$2.95
850215	22g X 1 1/2", 50/BX	\$2.95
850310	23g X 1", 50/BX	\$2.95
850810	18g X 1", 50/BX	\$2.95

200 SERIES ALUMINUM HUB NEEDLES

200086	18 X 1 1/2, SHORT BEVEL, ALUM HUB, 100/BX	\$9.95
200227	20 X 1, SHORT BEVEL, ALUM HUB, 100/BX	\$9.95
200573	14 X 2, ALUM HUB, 100/BX	\$14.95

WHILE SUPPLIES LASTS

Magellan™ safety needles are needle based safety devices that protect the healthcare worker from accidental needlestick injuries.

BUY NOW

MONOJECT® VET PACK SYRINGES & NEEDLES

MONOJECT® SYRINGE VET PACK

503406	3cc, 20G X 1", L/S, 100/BX	\$9.95
503455	3cc, 22G X 1", L/S, 100/BX	\$9.95
503430	3cc, 20G X 1 1/2", L/S, 100/BX	\$9.95

WHILE SUPPLIES LASTS

201 SERIES VETERINARY ALUMINUM HUB NEEDLES

201407	27X 1/4, ALUM HUB, 100/BX	\$12.95
201449	22X 1, ALUM HUB, 100/BX	\$12.95
201456	22X 1 1/2, ALUM HUB, 100/BX	\$12.95
201563	20g X 1", 100/BX	\$12.95



COVIDIEN

MONOJECT® & Magellan® are registered trademarks of Covidien

Hurry, When They're Gone They're Gone!

13822 WEST BOULTON BLVD, METTAWA, IL 60045

WWW.SHOPMEDVET.COM

Phone 800-544-7521

56

Fax 800-204-2177

MONOJECT® BLOWOUT

FOR A LIMITED TIME WHILE SUPPLIES LAST!!!

MONOJECT® NEEDLES

Soft Pack Needles

18100	18g X 1", 100/BX	\$6.95
18112	18g X 1.5", 100/BX	\$6.95
19100	19g X 1", 100/BX	\$6.95
19112	19g X 1.5", 100/BX	\$6.95
20100	20g X 1", 100/BX	\$6.95
20112	20g X 1.5", 100/BX	\$6.95
22112	22g X 1.5", 100/BX	\$6.95
23100	23g X 1" 100/BX	\$6.95
25058	25g X 5/8", 100/BX	\$6.95
25100	25g X 1", 100/BX	\$6.95
25112	25g X 1.5", 100/BX	\$6.95
30340	30g X 3/4", 100/BX	\$11.95

250 Series Hard Pack Needles

250222	22g X 1", 100/BX	\$6.95
250255	23 X 1, 100/BX	\$5.95
250545	25 X 1 1/2, 100/BX	\$5.95

Hard Pack Needles

21100	21g X 1", 100/BX	\$6.95
21112	21g X 1 1/2", 100/BX	\$6.95
250149	21g X 1.5", 100/BX	\$6.95

Hard Pack Needles

250255	23g X 1", 100/BX	\$6.95
22100	22g X 1", 100/BX	\$6.95
250255	23g X 1", 100/BX	\$6.95

Veterinary Hard Pack Needles

251840	21 X 1, VET PAK, 100/BX	\$5.95
--------	-------------------------	--------

Filter Needles

305018	FILTER, 20 X 1 1/2, 100/BX	\$9.95
305117	18g X 1 1/2", FILTER NEEDLE, 100/BX	\$9.95

Aluminum Hub Needle

200086	18 X 1 1/2" 100/BX SHORT BEVEL	\$9.95
200169	19 X 1	\$14.95
200185	20 X 1 1/2	\$14.95
201449	22 X 1 100/BX	\$12.95
200342	22 X 1	\$14.95
201456	22 X 1 1/2 100/BX	\$12.95
200227	20g X 1", SHORT BEVEL, 100/BX	\$9.95
200433	25 X 1 1/4, 100/BX	\$9.95
201407	27 X 1/4 100/BX	\$12.95

WHILE SUPPLIES LASTS

MONOJECT® & Magellan® are registered trademarks of Covidien

SURPLUS SYRINGE BLOWOUT

BD SYRINGE

WITH NEEDLE COMBO

\$4.00/bx
#305785

Eclipse SAFETY SYRINGE COM-
BO, 5CC 22G X 1 1/2", 50/BX



- Single-handed activation
- No hard surface required for activation
- Bevel-oriented needle allows for low-angle injections
- BD PrecisionGlide™ needles minimize injection pain and patient discomfort

CARDINAL SYRINGE

WITH NEEDLE COMBO

\$5.00/bx

Latex-free general-use syringe/
needle combinations offer a clear
barrel for superior content visu-
alization and accurate, bold scale
markings for dosage accuracy.

3cc 21G X 1", 100/BX

#SN0032110



LIMITED SUPPLY WHILE SUPPLIES LAST

13822 WEST BOULTON BLVD. METTAWA, IL 60045

WWW.SHOPMEDVET.COM

Phone 800-544-7521

57

Fax 800-204-2177

Syringes & Needles

Vet-Syringe & Terumo

VET-SYRINGE



BUY NOW

SYRINGES AND NEEDLES

1cc		
1CC25X5/8VS	1cc 25g x 5/8", Vet Use, T.B. 100/bx	\$6.99/bx
3cc		
3CC20X1.5VL	3cc 20g x 1 1/2", Vet Use, L/L 100/bx	\$5.99/bx
3CC20X1VL	3cc 20g x 1", Vet Use, L/L 100/bx	\$5.99/bx
3CC21X1VL	3cc 21g x 1", Vet Use, L/L 100/bx	\$5.99/bx
3CC22X1VL	3cc 22g x 1", Vet Use, L/L 100/bx	\$5.99/bx
3CC22X3/4VL	3cc 22g x 3/4", Vet Use, L/L, 100/bx	\$5.99/bx
3CC23X1VL	3cc 23g x 1", Vet Use, L/L, 100/bx	\$5.99/bx

SYRINGES ONLY

1cc		
1CCVLS	1cc L/S, Syringe only, Vet use, 100/bx	\$5.99/bx
3cc		
3CCVLL	3cc L/L, Syringe only, Vet use, 100/bx	\$4.99/bx
3CCVLS	3cc L/S, Syringe only, Vet use, 100/bx	\$4.99/bx
5cc		
5CCVLL	5cc L/L, Syringe only, Vet use, 100/bx	\$6.99/bx
5CCVLS	5cc L/S, Syringe only, Vet use, 100/bx	\$6.99/bx
10cc		
10CCVLL	10cc L/L, Syringe only, Vet use, 100/bx	\$9.99/bx
20cc		
20CCVELS	20cc eccentric L/S, Syringe only, Vet use, 50/bx	\$11.99/bx
20CCVLL	20cc L/L, Syringe only, Vet use, 50/bx	\$11.99/bx
30cc		
30CCVELS	30cc Eccentric L/S 30/bx	\$8.99/bx
30CCVLL	30cc L/L 30/bx	\$8.99/bx
60cc		
60CCVELS	60cc Eccentric L/S, Syringe Only, Vet Use, 25/bx	\$8.99/bx
60CCVCT	60cc, Catheter Tip, Syringe Only, Vet use, 25/bx	\$8.99/bx
60CCVLL	60cc luer lock, Syringe only, Vet use, 25/bx	\$8.99/bx

Terumo Syringe & Needle Combo

TERUMO®



Insulin & T.B.

05M2813	1/2cc 28x1/2 Insulin 100/bx	\$11.95/bx
01T	1cc L/S, T.B. 100/bx	\$9.95/bx
01T2516	1cc 25g x 5/8" T.B. 100/bx	\$12.95/bx
01T2713	1cc 27g x 1/2" T.B. 100/bx	\$12.95/bx
05M2913	1/2cc 29g x 1/2" Insulin 100/bx	\$11.95/bx
10M2813	1cc 28g x 1/2" Insulin 100/bx	\$11.95/bx

3cc		
03L2025	3cc 20g x 1", 100/bx	\$9.50/bx
03L2038	3cc 20g x 1 1/2", 100/bx	\$9.50/bx
03L2125	3cc 21g x 1", 100/bx	\$9.50/bx
03L2225	3cc 22g x 1", 100/bx	\$9.50/bx
03L2238	3cc 22g x 1 1/2", 100/bx	\$9.50/bx
03L2325	3cc 23g x 1", 100/bx	\$9.50/bx
03L2338	3cc 23g x 1.5", 100/bx	\$9.50/bx
03L2516	3cc 25g x 5/8", 100/bx	\$9.50/bx
03L2525	3cc 25g x 1", 100/bx	\$9.50/bx

Featuring SureVet Needles

T00098	3cc 22g x 1" SurVet L/S 100/bx	\$9.50/bx
100276	3cc 22g x 3/4" SurVet L/L 100/bx	\$9.50/bx
100278	3cc 25g x 5/8" SurVet L/L 100/bx	\$9.50/bx
100103	3cc 25 x 5/8" SurVet L/S 100/bx	\$9.50/bx

Terumo SurVet Needle

100279	22g x 3/4" Terumo 100/bx	\$9.95/bx
--------	--------------------------	-----------

Terumo Syringes

BUY NOW

Assorted Sizes

03L	3cc L/L 100/bx	\$8.95/bx
03S	3cc L/S 100/bx	\$8.95/bx
05L	5cc L/L 100/bx	\$13.50/bx
05S	5cc L/S 100/bx	\$13.50/bx
10L	10cc L/L 100/bx	\$13.95/bx
10S	10cc L/S 100/bx	\$13.95/bx
20L2	20cc L/L 50/bx	\$17.95/bx
20S2	20cc L/S 50/bx	\$17.95/bx
30L	30cc L/L 25/bx	\$10.95/bx
30S	30cc L/S 25/bx	\$10.95/bx
60C	60cc Catheter Tip 25/bx	\$15.95/bx
60ES	60cc Ecc Tip 25/bx	\$15.95/bx
60L	60cc L/L 25/bx	\$15.95/bx

Terumo Needles

1838RN	18g x 1.5" 100/bx	\$5.95/bx
1825RN	18g x 1" 100/bx	\$5.95/bx
1925RN	19g x 1" 100/bx	\$5.95/bx
2025RN	20g x 1" 100/bx	\$5.95/bx
2038RN	20g x 1.5", 100/bx	\$5.95/bx
2125RN	21g x 1" 100/bx	\$5.95/bx
2225RN	22g x 1" 100/bx	\$5.95/bx
2238RN	22g x 1.5" 100/bx	\$5.95/bx
2325RN	23g x 1" 100/bx	\$5.95/bx
2525RN	25g x 1" 100/bx	\$5.95/bx
2516RN	25g x 5/8" 100/bx	\$5.95/bx
2538RN	25g x 1 1/2" 100/bx	\$5.95/bx
2338RN	23 x 1 1/2 100/bx	\$5.95/bx

Syringes & Needles

Ulticare & Excel

Ulticare Veterinary U40 Insulin Syringe

Inside Ulticare's innovative Dispense and Dispose container you'll find 100 premium quality U40 insulin syringes. All for less than a box of the leading syringe.

07260	0.5cc, 29g, 1/2 inch needle, 100/box	\$21.35/bx
07261	1.0cc, 29g, 1/2 inch needle, 100/box	\$19.99/bx

U40 Insulin Syringe

ISU400529	0.5cc, 29g, 1/2 inch needle, 100/box	\$9.95/bx
ISU401029	1cc, 29g, 1/2 inch needle, 100/box	\$9.95/bx

BUY NOW



- Latex Free Products
- Non-Toxic
- Sterile & Non-Pyrogenic
- Positive Plunger stop to prevent spillage when drawing
- Smooth plunger motion
- Polypropylene construction

BUY NOW

EXEL^{INT}
MEDICAL PRODUCTS

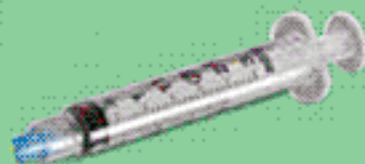

Exel 3cc Syringe with Needle

26100		\$8.50/bx
26102	3cc, 22g x 1", LL, 100/box	\$8.50/bx
26108	3cc, 20g x 1", LL, 100/box	\$8.50/bx
26110	3cc, 18g x 1.5", LL, 100/box	\$8.50/bx
26115	3cc, 22g x 3/4", LL, 100/box	\$8.50/bx
26601	3cc, 22g x 3/4", LS, 100/box	\$8.50/bx

Exel Syringes

26048	1cc tuberculin, luer slip, 100/box	\$13.55/bx
26200	3cc, LL, 100/box	\$8.95/ea
26201	3cc, LS, 100/box	\$8.95/bx
26231	5-6cc, LS, 100/box	\$18.00/bx
26265	10-12cc, LL, 100/box	\$19.70/bx
26266	10-12cc, LS, 100/box	\$19.70/bx
26267	10-12cc, curved tip, non-sterile, feeding, 50/box	\$16.99/bx

Exel T.B. Syringe with Needle

26044	1cc tuberculin, 25g x 5/8", 100/box	\$17.35/bx
-------	-------------------------------------	------------

Syringes & Needles

B-D Syringes and Needles



BUY NOW



B-D Luer-Lock Tip Syringe

309585	3cc, L/L 100/bx	\$11.99/bx
309646	5cc, L/L, 125/bx	\$19.95/bx
309647	Syringe B-D 5cc Luer Slip, 125/BX Syringe	\$16.95/bx
309604	10cc, L/L, 100/bx	\$18.99/bx
309661	20cc, L/L, 40/bx	\$16.99/bx
309650	30cc, L/L, 40/bx	\$19.99/bx
309653	60mL, L/L 40/bx	\$23.99/bx

B-D Syringe Luer Slip

301625	20cc Luer Slip, 40/bx	\$16.99/bx
301603	5cc luer slip, 40/bx	\$14.99/bx

B-D Syringe & Needle Combo

309626	1cc 25g x 5/8, T.B. 100/bx	\$19.99/bx
309580	3cc 18g x 1 1/2", 100/bx	\$14.99/bx
309579	3cc 20 x 1 1/2, 100/bx	\$14.99/bx
309578	3cc 20g x 1", 100/bx	\$14.99/bx
309575	3cc 21g x 1", 100/bx	\$14.99/bx
309574	3cc 22g x 1 1/2", 100/bx	\$14.99/bx
309572	3cc 22g x 1", 100/bx	\$14.99/bx
309571	3cc 23g x 1", 100/bx	\$14.99/bx
309582	3cc 25g x 1 1/2", 100/bx	\$14.99/bx
309581	3cc 25g x 1", 100/bx	\$14.99/bx
309570	3cc 25g x 5/8, 100/bx	\$14.99/bx

B-D Needles

305198	16g x 1 1/2", 100/bx	\$14.95/bx
305197	16g x 1", 100/bx	\$14.95/bx
305196	18g x 1 1/2", 100/bx	\$7.95/bx
305195	18g x 1", 100/bx	\$7.95/bx
305175	20g x 1", 100/bx	\$7.95/bx
305165	21g x 1", 100/bx	\$7.95/bx
305156	22g x 1 1/2", 100/bx	\$7.95/bx
305155	22g x 1", 100/bx	\$7.95/bx
305145	23g x 1", 100/bx	\$7.95/bx
305127	25g x 1 1/2", 100/bx	\$7.95/bx
305125	25g x 1", 100/bx	\$7.95/bx
305122	25g x 5/8", 100/bx	\$7.95/bx
305136	27g x 1 1/4", 100/bx	\$7.95/bx
305128	30g x 1", 100/bx	\$19.95/bx
305106	30g x 1/2", 100/bx	\$19.95/bx



Easy Touch™ Insulin Syringe

BUY NOW



EasyTouch™ Insulin Syringes are designed and manufactured to deliver the highest level of comfort to the consumer. Our special needles are triple-bevel cut to a super sharp point, electro-polished to remove microscopic burrs, and film coated for a smoother injection.

Picture used as a graphic representation actual product may vary

830165	1cc 30g x 5/16" U-100 insulin 100/bx	\$14.95/bx
830365	3/10cc 30g x 5/16" U-100 insulin 100/bx	\$14.95/bx
830565	1/2cc 30g x 5/16" U-100 insulin 100/bx	\$14.95/bx

Jorvet Dose Syringe

Dose Syringe - 400cc capacity: over 13 ounces. Manufactured with an almost unbreakable, clear nylon barrel excellent for use with stomach tubes or for rinsing out the mouth before a dental procedure. Includes silicone lubricant. Nozzle: 4" L. 1/4" i.d. dia

JOR111JW	Dose syringe, 400cc	\$54.60/ea
JOR111JWL	Dose syringe, 600 ml	\$81.00/ea
JOR111JWO	O-Ring for 400cc	
JOR111JWLD1	O-Ring for 600cc dose syringe	\$4.50/ea
JOR111JWD1	Nozzle pipe only	\$26.00/ea

Jorvet



BUY NOW



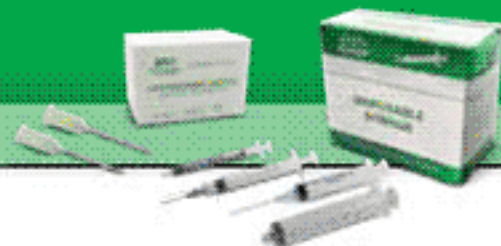

NIPRO®

Nipro Syringes

BUY NOW

JD01T	1cc Syringe L/S, T.B. 100/Bx	\$9.95/bx
JD03L	3cc L/L 100/bx	\$6.95/bx
JD03S	3cc L/S 100/bx	\$6.95/bx
JD05L	5cc L/L 100/bx	\$11.95/bx
JD05S	5cc L/S 100/bx	\$11.95/bx
JD10L	10cc L/L 100/bx	\$14.95/bx
JD10S	10cc L/S 100/bx	\$14.95/bx
JD20ES	20cc E/L/S 50/bx	\$19.99/bx
JD20L	20cc L/L 50/bx	\$19.99/bx
JD30ES	30cc E/L/S 50/bx	\$22.95/bx
JD30L	30cc L/L 50/bx	\$22.95/bx
JD50ES	50cc E/L/S 25/bx	\$14.50/bx
JD50L	50cc L/L 25/bx	\$14.95/bx



Nipro Luer Adapter (Multi-Sample)

Designed for optimum efficiency: Luer Adapter allows for multiple draws with a single view of patient needs. Dual capability permits use for either blood collection or a venous injection. Proprietary back end needle design facilitates smooth penetration of rubber tube stopper.

LM20G	Luer Adapter Multi-Sample, 100/Bx	\$14.50/bx
-------	-----------------------------------	------------

Blood Collection Needle **BUY NOW**

- Multiple-Draw needle design provides the convenience of several sample collections with a single venipuncture.
- Needle is ultra-sharp and with smooth edges for atraumatic insertion and easy penetration.
- Color-coded hubs assure accurate and convenient gauge size identification.

NM20G38	20g x 1 1/2" 100/bx	\$8.95/bx
NM20G25	20g x 1" 100/bx	\$8.95/bx
NM21G38	21g x 1 1/2" 100/bx	\$8.95/bx
NM21G25	21g x 1" 100/bx	\$8.95/bx
NM22G38	22g x 1 1/2" 100/bx	\$8.95/bx
NM22G25	22g x 1" 100/bx	\$8.95/bx

Nipro Syringe and Needle Combo

JD01T2516	1cc, 25 x 5/8" T.B. 100/bx	\$11.95/bx
JD01T2609	1cc 26 x 3/8 T.B. 100/bx	\$11.95/bx
JD01T2713	1cc 27x1/2 T.B. 100/bx	\$11.95/bx
JD03L2025	3cc 20 x 1 L/L 100/bx	\$7.95/bx
JD03L2038	3cc 20 x 1 1/2 L/L 100/bx	\$7.95/bx
JD03S2025	3cc 20 x 1 L/S 100/bx	\$7.95/bx
JD03L2125	3cc 21 x 1 L/L 100/bx	\$7.95/bx
JD03L2238	3cc 22 x 1 1/2 L/L 100/bx	\$7.95/bx
JD03L2225	3cc 22 x 1 L/L 100/bx	\$7.95/bx
JD03S2225	3cc 22 x 1 L/S 100/bx	\$7.95/bx
JD03L2219	3cc 22 x 3/4 L/L 100/bx	\$7.95/bx
JD03S2219	3cc 22 x 3/4 L/S 100/bx	\$7.95/bx
JD03S2516	3cc 22 x 5/8 L/S 100/bx	\$7.95/bx
JD03L2325	3cc 23 x 1 L/L 100/bx	\$7.95/bx
JD03L2538	3cc 25 x 1 1/2 L/L 100/bx	\$7.95/bx
JD03L2525	3cc 25 x 1 L/L 100/bx	\$7.95/bx
JD03L2516	3cc 25 x 5/8 L/L 100/bx	\$7.95/bx
JD05L2038	5cc 20 x 1 1/2 L/L 100/bx	\$17.95/bx
JD05L2025	5cc 20 x 1 L/L 100/bx	\$17.95/bx
JD05L2138	5cc 21 x 1 1/2 L/L 100/bx	\$17.95/bx
JD05L2225	5cc 22 x 1 L/L 100/bx	\$17.95/bx
JD05L2238	5cc 22 x 1 1/2 L/L 100/bx	\$17.95/bx
JD10L2038	10cc 20 x 1 1/2 L/L 100/bx	\$17.95/bx
JD10L2025	10cc 20 x 1 L/L 100/bx	\$17.95/bx
JD10L2238	10cc 22 x 1 1/2 L/L 100/bx	\$17.95/bx
JD10L2225	10cc 22 x 1 L/L 100/bx	\$17.95/bx

Nipro Needles **BUY NOW**

AH1838	18g x 1 1/2" 100/bx	\$4.95/bx
AH1825	18g x 1" 100/bx	\$4.95/bx
AH2038	20g x 1 1/2" 100/bx	\$4.95/bx
AH2025	20g x 1" 100/bx	\$4.95/bx
AH2125	21g x 1" 100/bx	\$4.95/bx
AH2238	22g x 1 1/2" 100/bx	\$4.95/bx
AH2225	22g x 1" 100/bx	\$4.95/bx
AH2219	22g x 3/4" 100/bx	\$4.95/bx
AH2325	23g x 1" 100/bx	\$4.95/bx
AH2525	25g x 1" 100/bx	\$4.95/bx
AH2538	25g x 1 1/2" 100/bx	\$4.95/bx
AH2516	25g x 5/8" 100/bx	\$4.95/bx
AH2732	27g x 1 1/4" 100/bx	\$4.95/bx
AH3013	30g x 1/2" 100/bx	\$6.95/bx

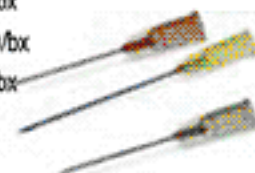

Syringes & Needles

Nylon & Bulb Syringes, Caps & Drenchers

Nylon Syringe Jorgensen

The nylon syringe, with an expanded range of sizes, is now available. Virtually unbreakable nylon with transparent barrel, economically priced with easy-to-read black etched dose markings. Combination of luer lock and luer slip adaptor.



JOR111AN	10cc	\$6.45/ea
JOR111BN	20cc	\$6.95/ea
JOR111CN	30cc	\$7.55/ea
JOR111DN	50cc	\$8.95/ea
JOR111FN	100cc	\$12.00/ea

With Dosage Wheel

JOR111AWN	Includes dosage wheel. 10cc.	\$8.65/ea
JOR111BWN	Includes dosage wheel. 20cc.	\$8.00/ea
JOR111CWN	Includes dosage wheel. 30cc.	\$8.70/ea
JOR111DWN	Includes dosage wheel. 50cc.	\$9.90/ea

O Ring Only

JOR111ANO	10cc, "O" ring.	\$0.90/ea
JOR111BNO	20cc, "O" ring.	\$0.90/ea
JOR111CNO	30cc, "O" ring.	\$1.05/ea
JOR111DNO	50cc, "O" ring.	\$1.50/ea
JOR111FNO	100cc, "O" ring.	\$1.35/ea

Sheep/Goat Oral Drencher Kit

A handy kit that has everything needed for drenching small ruminants. Includes an extra "O" ring to fit a 20cc nylon syringe, and an oral dose adaptor.

JOR111Q \$13.50/ea



Silicone Lubricant

JOR111SG 1 gallon \$107.00/ea
 JOR111S 30ml. \$4.80/ea



BUY NOW

Needle Counter

Red plastic box allows you to count the needles and blades plus gives you ability to secure them, insuring the safety of the surgical personnel during procedures. Foam Block/Adhesive, 20 ct.

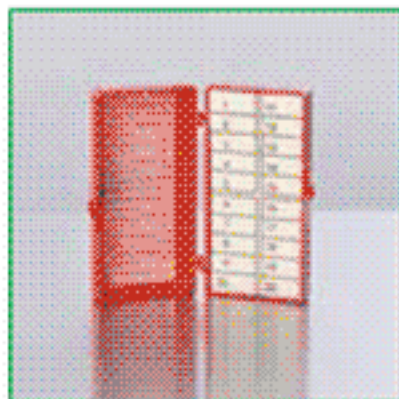

DYNJNC20A 20 ct, 64/cs

\$103.00/cs

Ear-Ulcer Syringe

BUY NOW

Soft pliable material makes these syringes safe and easy to use. Whether irrigating or suctioning, the smooth tapered tip facilitates fluid administration/retrieval and reduces trauma. Ribbed bulb provides a non-slip grip.

EAR-SYR-10Z	1oz	\$0.95/ea
EAR-SYR-20Z	2oz	\$1.49/ea
EAR-SYR-30Z	3oz	\$1.49/ea

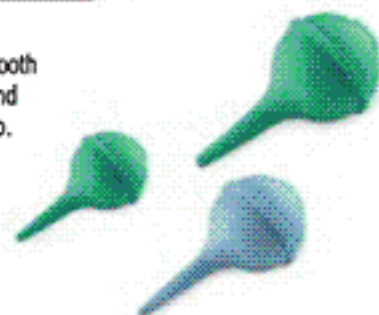

Ear Syringe

The ear/ulcer syringe is ideal for irrigating smaller wounds and cleansing nasal passages of newborns.

DYND70280	2oz, 50/cs	\$52.11/cs
DYND70277	3oz, 50/cs	\$52.11/cs

BUY NOW

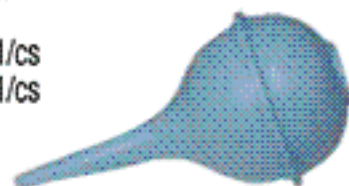

Jorvet Bulb Syringe



Excellent for aspiration of surgical sites. Also can be used to flush surgical sites. The rubber bulb is attached to a 60ml syringe, thus, 60ml capacity. Sterile.

JOR487B \$2.10/ea

BUY NOW

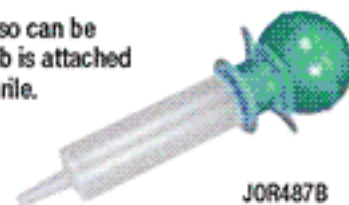

JOR487B

Feeding Syringe

Feeding and Irrigation Syringe: This kit includes a flat-top 60 cc piston syringe with luer tip adapter, I.V. pole bag with resealable flap and write-on patient I.D. Label. Irrigation/feeding syringe, IV pole bag, luer tip adapter, flat ring plunger, rounded with flat top, 60cc. 30 a case

DYND70642 Feeding Syringe Flat Tip w/Ring \$13.79/cs



Piston Syringe

BUY NOW

Contro-Piston Irrigation Syringe: Contro-Piston Syringe Offers Uninterrupted Action in a Single-Hand Technique The sterile, disposable syringe with thumb ring is designed to minimize hand slippage and prevent contamination. The barrel features raised, large and easy-to-read graduations, which are calibrated in oz and cc. The tip, elongated to facilitate tube feeding, has an extra-large orifice for better removal of clots and mucous shreds. Includes: Soft Tray and Paper Lidding. 50 a case

DYND20325 60mL Syringe \$39.95/cs



Syringes & Needles

Henke Roux Revolver & Ferromatic Automatic Syringe

Henke Roux Revolver **Jorvet**

A high quality precision-made revolver syringe. Of German origin it's known for its accuracy. Dosage is set by turning the dosage setting wheel at the rear of the barrel. For long lasting dependability, durability and accuracy, buy the "HENKE" Roux.

JOR53HB Henke Roux. 10cc, adjusts to 1/4, 1/2 & 1cc. \$57.00

BUY NOW

Henke Roux Revolver Parts

JOR53D12	Cap for #11 spring	\$0.60	JOR53D26	Glass barrel, 50cc	\$4.20
JOR53D18	Compressing spring	\$0.45	JOR53D42	Henke set screw	\$3.35
JOR53D44	Compression spring	\$2.10	JOR53D43	Henke steel ball, 4 mm	\$1.80
JOR53D31B	Disc for piston, 10cc	\$3.30	JOR53D28B	Inner rod, 10cc	\$7.05
JOR53D31	Disc for piston, 30cc & 50cc	\$1.65	JOR53D28A	Inner rod, 30cc	\$7.05
JOR53D20B	Dosage wheel, 10cc	\$6.00	JOR53D28	Inner rod, 50cc	\$7.05
JOR53D20	Dosage wheel, 30cc & 50cc	\$6.90	JOR53D33	Knurled knob	\$6.00
JOR53D36	Dosage wheel, 30cc minidose	\$9.00	JOR53D27B	Metal frame, 10cc	\$14.40
JOR53D24B	Front end with luerlock, 10cc	\$13.50	JOR53D27A	Metal frame, 30cc	\$14.70
JOR53D24	Front end with luerlock, 30cc & 50cc	\$10.60	JOR53D27	Plastic barrel with luerlock, 50cc	\$14.70
JOR53D26B	Glass barrel, 10cc	\$3.90	JOR53D32B	Outer rod, 10cc	\$9.60
JOR53D26A	Glass barrel, 30cc	\$3.90	JOR53D32A	Outer rod, 30cc	\$9.60
JOR53D13	Gudgeon bolt	\$1.35	JOR53D37	Outer rod, 30cc minidose	\$4.50
JOR53D7	Handle connecting screw	\$6.15	JOR53D32	Outer rod, 50cc	\$9.60
JOR53D55	Henke dosage repair kit (incl. 2, 11, 42, 43)	\$7.50	JOR53D260	Plastic barrel, 30cc	\$2.40
JOR53D49	Henke dosage wheel	\$19.50	JOR53D26P	Plastic barrel, 50cc	\$3.90
JOR53D2	Henke dosage wheel screw	\$1.50	JOR53D26R	Plastic barrel with luerlock, 50cc	\$10.50
JOR53D53	Henke forward handle, complete	\$24.00	JOR53D14	Ratchet tip	\$5.55
JOR53D56	Henke plunger rod kit (incl. 28, 30, 31, 32, 33) Henke plunger rod kit (incl. 28, 30, 31, 32, 33)	\$27.00	JOR53D1B	Rear grip, 10cc	\$33.00
JOR53D51	Henke ratchet clip	\$1.50	JOR53D1	Rear grip, 30cc & 50cc	\$36.00
JOR53D52	Henke ratchet screw	\$1.80	JOR53D30B	Rubber piston, 10cc	\$3.00
JOR53D45	Henke rear handle, complete	\$46.00	JOR53D30	Rubber piston, 30cc & 50cc	\$1.80
JOR53D54	Henke Roux repair kit	\$21.00	JOR53D35	Spring for handles	\$3.90
			JOR53D25B	Washer set, 10cc	\$3.30
			JOR53D25	Washer set, 30cc & 50cc	\$3.30

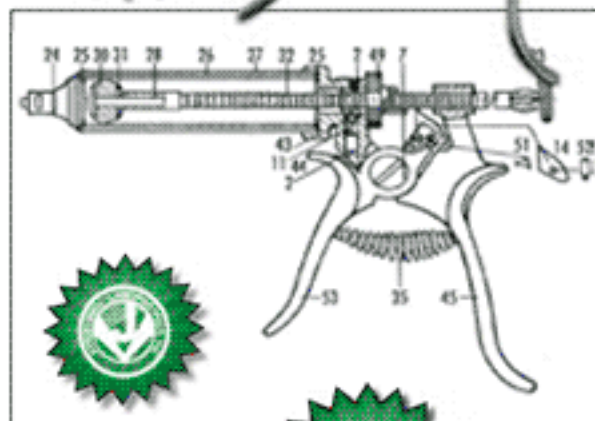

Ferromatic Automatic Syringe **Jorvet**

Unique design has dosage adjustments from .5ml to 5.0ml. Fits bottle tops from 30ml-120ml.

Features:

- One-piece front end with luer lock
- A valve accessory allowing user to adapt the syringe for use with a collapsible bottle (part #14c optional)
- Tubing and attachment to allow draw offs from bottles (optional)
- New plastic valve system to prevent valve "swelling"

JOR53F91 5cc, M91 \$116.00

BUY NOW

Ferromatic Automatic Syringe Parts

JOR53FD191	Barrel Frame, M91	\$27.00	JOR53FD16	Outlet valve spring*	\$0.00
JOR53FD21	Closing cap	\$2.70	JOR53FD591	Piston rod and handle, M91	\$10.50
JOR53FD11	Compression spring	\$3.90	JOR53FD27	Piston rod assembly, 3, 4, 5, 6	\$12.00
JOR53FD1191	Compression spring, M91	\$3.00	JOR53FD391	Piston, M91	\$5.50
JOR53FD6	Crutch handle	\$3.00	JOR53FD2891	Repair kit (4, 10M, 2 of 1291, 1391, 1691,	\$30.00
JOR53FD8	Dosing device	\$4.50	JOR53FD28	Repair kit (4, 10, 3 of 12, 13, 16, 17,	\$21.60
JOR53FD891	Dosing device M91	\$6.00		18, 20, 25)	
JOR53FD8M	Dosing device, M96	\$4.50	JOR53FD28M	Repair kit (4, 10M, 3 of 12, 13, 16,	\$21.60
JOR53FD10M	End washer, M86 & M91	\$1.80		17, 18, 20, 25)	
JOR53FD9	Fixing nut	\$2.25	JOR53FD12	Rubber valve*	\$3.00
JOR53FD991	Fixing nut, M91	\$2.25	JOR53FD19M	Screw cap - 07	\$9.00
JOR53FD1M	Frame, M86	\$24.00	JOR53FD19	Screw cap	\$4.50
JOR53FD2291	Front piece, M91	\$34.00	JOR53FD3191	Tubing	\$6.00
JOR53FD691	Front screw	\$10.50	JOR53FD3291	Attachment	\$6.00
JOR53FD2M	5cc, M86, M91	\$7.80	JOR53FD14C	Valve head, M91, collapsible bottle	\$43.00
JOR53FD7	Guiding cap	\$1.80	JOR53FD14G	Valve head, M91, non-collapsible bottle	\$30.00
JOR53FD791	Guiding cap M91	\$6.00	JOR53FD15	Valve head screw*	\$3.00
JOR53FD7M	Guiding cap, M86	\$1.80	JOR53FD14V91	Valve screw	\$6.00
JOR53FD23	Luerlock adaptor	\$4.50	JOR53FD1391	Valve spring	\$2.60
JOR53FD4	O-Ring Washer piston	\$2.40	JOR53FD18	Washer for 14c	\$0.00
JOR53FD3	Piston	\$3.30	JOR53FD20	Washer for 14g*	\$0.00
JOR53FD5M	Piston rod and handle, M86	\$9.00	JOR53FD4M	Washer piston	\$1.80

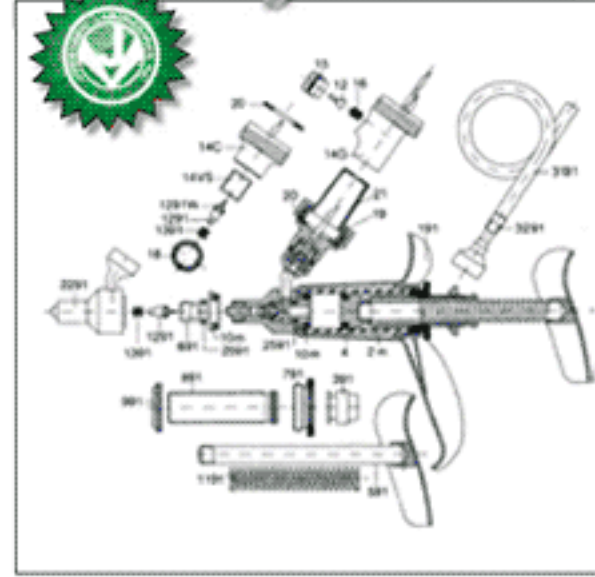

Syringes & Needles

Hauptner & Vetamatic Syringes

Hauptner Syringe **Jorvet**

Famously accurate and correct dosing.

BUY NOW

JOR31A	10cc, adjusts to 1/4, 1/2, 3/4, and 1cc doses.	NEW	\$108.00
JOR31B	30cc, adjusts to 1, 2, 3, 4, and 5cc doses.		\$83.00
JOR31C	50cc, adjusts to 1, 2, 3, 4, and 5cc doses.		\$88.35
JOR31E	25cc, adjusts to 1/2, 1, 1 1/2, 2 and 2 1/2. Excellent for injecting homec@		\$112.50

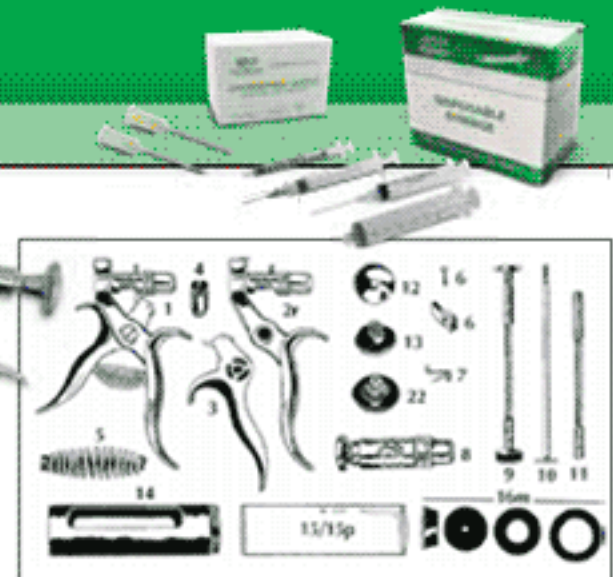

Hauptner Syringe Parts

JOR31TBM0	2cc Glass barrel	\$31.00
JOR31D1	Complete grip, 30cc & 50cc Complete grip, 30cc & 50cc	\$66.50
JOR31D22	Luerlock with endplate, 30cc & 50cc	\$6.60
JOR31D15A	Glass barrel, 10cc	\$3.90
JOR31D15E	Glass barrel, 25cc	\$3.90
JOR31D15B	Glass barrel, 30cc	\$3.90
JOR31D15C	Glass barrel, 50cc	\$3.90
JOR31D23	HAUPTNER repair kit (incl. 6, 7, 15c, 16m)	\$13.80
JOR31D10A	Inner rod, 10cc	\$8.40
JOR31D10E	Inner rod, 25cc	\$7.50
JOR31D10B	Inner rod, 30cc	\$8.70
JOR31D10C	Inner rod, 50cc	\$7.50
JOR31D22A	Luerlock with endplate, 10cc	\$9.00
JOR31D22E	Luerlock with endplate, 25cc	\$13.50
JOR31D14A	Metal cover, 10cc	\$15.00
JOR31D14E	Metal cover, 25cc	\$21.00
JOR31D14B	Metal cover, 30cc	\$15.00

JOR31D14C	Metal cover, 50cc	\$15.60
JOR31D11A	Outer rod, 10cc	\$9.00
JOR31D11E	Outer rod, 25cc	\$9.00
JOR31D11B	Outer rod, 30cc	\$9.30
JOR31D11C	Outer rod, 50cc	\$8.40
JOR31TBM	Perpendo TB syringe, 2cc	\$129.00
JOR31D16PPE	Piston rubber (only 25cc)	\$1.50
JOR31D15PB	Plastic barrel, 30cc	\$2.40
JOR31D15PC	Plastic barrel, 50cc	\$3.90
JOR31D12A	Plate for plunger, 10cc	\$4.50
JOR31D12E	Plate for plunger, 25cc	\$4.50
JOR31D12	Plate for plunger, 30cc & 50cc	\$2.70
JOR31H	Revolver Holder	\$0.00
JOR31D1A	Complete grip, 10cc	\$80.00
JOR31D1E	Complete grip, 25cc	\$66.50
JOR31D2RA	Thumb grip with regulator, 10cc	\$39.00
JOR31D2RE	Thumb grip with regulator, 25cc	\$42.00
JOR31D3	Grip with ratchet	\$27.00

JOR31D4	Lock screw	\$1.95
JOR31D8A	Dosage regulator, 10cc	\$24.00
JOR31D9A	Complete plunger, 10cc	\$22.80
JOR31D9B	Complete plunger, 30cc	\$24.00
JOR31D9C	Complete plunger, 50cc	\$22.50
JOR31D9E	Complete plunger, 25cc	\$24.00
JOR31TBC	TB caliper	\$90.00
JOR31TBN	TB needle	\$12.60
JOR31D13A	Tension screw, 10cc	\$3.90
JOR31D13	Tension screw, 25cc, 30cc, 50cc	\$3.90
JOR31D2A	Thumb grip less regulator, 10cc	\$28.00
JOR31D2	Thumb grip less regulator, 30cc & 50cc	\$19.50
JOR31D16A	Washer pack set, 10cc	\$4.50
JOR31D16E	Washer pack set, 25cc	\$4.50
JOR31D16	Washer pack set, 30cc & 50cc	\$4.20
JOR31D16M	Washer pack set, modified, 30cc & 50cc	\$4.50

Vetamatic Syringe, 5cc

A handy, sturdy automatic multidose syringe. Plastic valve and washer reduces swelling problems.

NOTE: Spare Parts Ordering: Parts 13, 1494 and 1694 as shown on parts diagram are not available individually. They can be purchased only as a repair kit: J-53vd 2894

JOR53V94 .5ml to 5.0ml. \$84.00/ea

Vetamatic Syringe Parts

JOR53VD794	Compression spring	\$2.40
JOR53VD9M	Dose fixing nut, M86	\$4.50
JOR53VD8M	Dosing screw and tube, M86	\$7.50
JOR53VD894	Dosing sheath	\$6.00
JOR53VD24A	Filler needle, 4 3/4"	\$10.50
JOR53VD24B	Filler needle, 7 1/2"	\$19.50
JOR53VD24C	Filler needle, 8 1/2"	\$19.50
JOR53VD994	Fixing nut	\$2.40
JOR53VD1794	Front end	\$18.00
JOR53VD17M	Front end, M86	\$21.00
JOR53VD294	Front screw	\$10.50
JOR53VD4M	Glass barrel, M86 & M91	\$7.80
JOR53VD1M	Metal frame	\$27.00
JOR53VD1294	Piston	\$4.50
JOR53VD594	Piston rod	\$28.00

JOR53VD2894	Repair kit (2 each of 13, 1494, 1694)	\$21.00
JOR53VD28	Repair kit (3, 11, 13, 2 of 14, 15, 16, 18)	\$18.00
JOR53VD28M	Repair kit M86 (3m, 13, 2 of 14, 15, 16, 18)	\$19.50
JOR53VD1094	Screw cap	\$6.00
JOR53VD10M	Screw cap, M86	\$4.20
JOR53VD26	Screw cap, M91	\$9.00
JOR53VD22	Sinker	\$2.25
JOR53VD6	Spring sleeve	\$2.10
JOR53VD7M	Spring, M86	\$3.90
JOR53VD23	Tubing	\$6.00
JOR53VD1494	Valve and washer	\$6.00

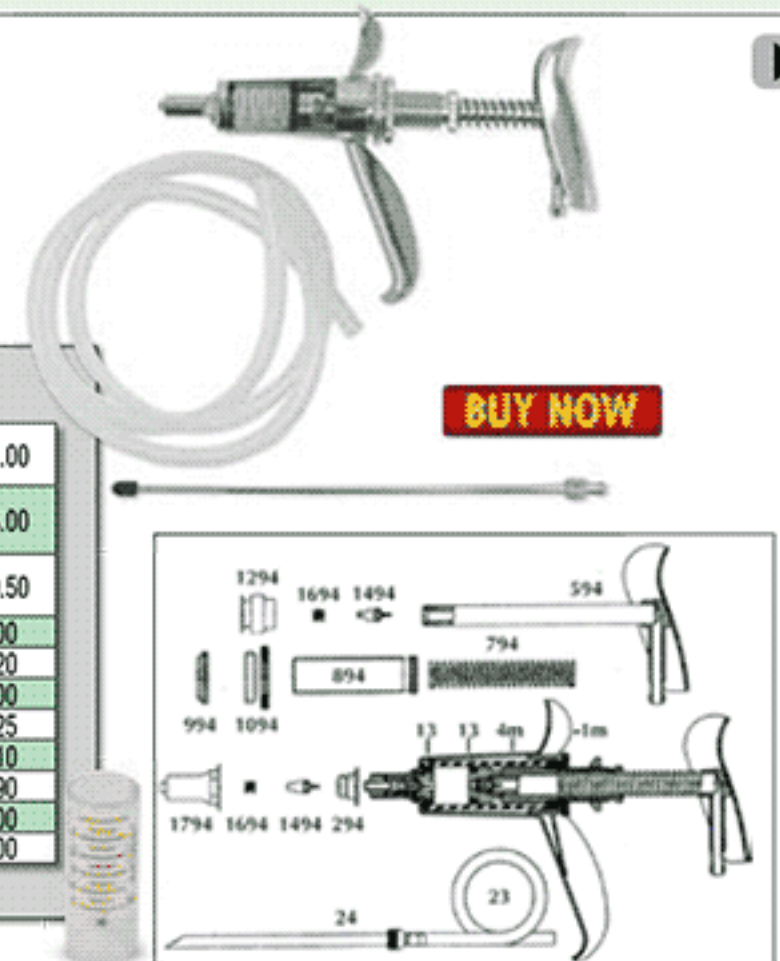

BUY NOW

Syringes & Needles

Vetamatic & Henke Drench-Matic Syringes

Henke Drench-Matic 23cc **JorVet**

An automatic syringe for administration of solutions and suspensions. Its transparent plastic graduated barrel allows instant check of dosage setting. An "anti-block" valve system prevents blocking, so that smooth continuous operation is guaranteed. Easily adjusts from 0-23ml in 2.5ml increments. Special hardened enamel painting provides both aesthetics and durability.

JOR128M Drench-Matic Syringe complete with container. \$172.00

Henke Drench-Matic Parts

JOR128MD1	Barrel frame	\$36.00/ea
JOR128MD32	Cap & nozzle	\$3.90/ea
JOR128MD31	Container complete	\$37.00/ea
JOR128MD24	Disc	\$1.80/ea
JOR128MD20	Dosing screw	\$7.80/ea
JOR128MD21	Dosing screw nut	\$7.50/ea
JOR128MD28	Feeding tube	\$10.50/ea
JOR128MD26	Frame screw	\$2.40/ea
JOR128MD3	Front end piece	\$15.00/ea
JOR128MD15	Front handle	\$33.00/ea
JOR128MD19	Handle screw	\$6.00/ea
JOR128MD22	Handle spring	\$6.00/ea
JOR128MD30	Injection attachment	\$15.00/ea
JOR128MD25	Knurled knob	\$12.00/ea
JOR128MD5	Lock nut for #3	\$3.00/ea
JOR128MD23	Lower spring screw	\$7.80/ea
JOR128MD8	Nozzle and washer	\$16.50/ea
JOR128MD9	Nozzle nut	\$7.50/ea

JOR128MD8W	Nozzle washer only	\$1.80/ea
JOR128MD14	Nylon piston	\$15.00/ea
JOR128MD11	Piston rod	\$28.00/ea
JOR128MD10	Piston rod complete (6,7,11,12,13,14)	\$47.00/ea
JOR128MD13	Piston washer	\$4.50/ea
JOR128MD2P	Plastic barrel, 23cc	\$10.50/ea
JOR128MD18	Plastic insert (2)	\$1.80/pr
JOR128MD17	Rear handle	\$40.00/ea
JOR128MD36	Repair kit (4,6,6w,8w,13,14,30w)	\$30.00/ea
JOR128MD4	Round washer	\$3.00/ea
JOR128MD16	Spring pin	\$1.20/ea
JOR128MD33	Straps	\$10.50/ea
JOR128MD6	Valve and washer	\$6.90/ea
JOR128MD12	Valve screw	\$9.00/ea
JOR128MD7	Valve spring	\$4.50/ea
JOR128MD30W	Washer for #30	\$2.10/ea



BUY NOW

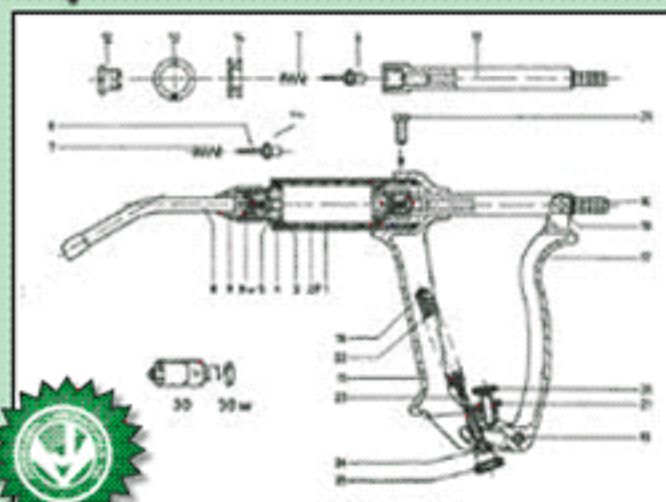

Vaxi-Drench 15 Injector/Drenche, 15cc

Designed for administration of all drenches or injectable solutions within its dose range. Comes complete with 2.9 liter vinyl reservoir, strapping, funnel and necessary tubing. Manufactured exclusively for Jorgensen Labs. Adjust from 2.5cc to 15cc in 1/2cc increments.

JOR126 Injector/Drencher \$274.00/ea **JorVet**



BUY NOW

Vetamatic Syringe Parts

JOR126D19	Adaptor	\$15.00
JOR126D31	Cap & nozzle	\$28.00
JOR126D29	Container complete	\$54.00
JOR126D18	Cylinder	\$24.00
JOR126D15	Cylinder cage	\$48.00
JOR126D17	Cylinder seal ring	\$3.90
JOR126D13	Lock nut	\$7.50
JOR126D23	Dosage adjustor screw & nut	\$7.50
JOR126D30	Feed tube & clamps	\$9.00
JOR126D22	Handle	\$30.00
JOR126D28	Handle clamp screw	\$2.70
JOR126D10	Injection attachment	\$24.00
JOR126D20	Lever	\$48.00
JOR126D21	Lever pad, set of 2	\$7.00
JOR126D27	Lever screw	\$12.00
JOR126D11	Needle nut	\$9.00

JOR126D12	Nozzle	\$15.00
JOR126D16	Nozzle nut	\$9.00
JOR126D9	Nozzle seal ring	\$2.70
JOR126D1	Piston cap	\$7.80
JOR126D5	Piston spacer	\$7.50
JOR126D4	Piston washer, (2)	\$6.75
JOR126D6	Push rod	\$38.00
JOR126D32	Repair kit, parts 2,3,4,7,8,9,17	\$22.50
JOR126D24	Return spring	\$6.00
JOR126D25	Return spring adjustor	\$12.00
JOR126D26	Return spring adjustor screw	\$9.00
JOR126D3	Valve & seal ring	\$8.70
JOR126D7	Valve & seal ring	\$8.70
JOR126D2	Valve spring	\$2.10
JOR126D8	Valve spring	\$2.10

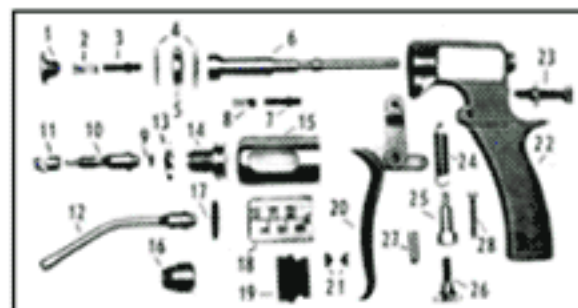

Syringes & Needles

Needles- Feeding, Straight and Curved

Curved Feeding Needle

Luerlock hub with stainless steel tube and nickel-plated silver ball on the end.

JOR194CAH	20g x 4"	\$45.00/ea
JOR194CBE	18g x 2"	\$38.00/ea
JOR194CCE	16g x 2"	\$46.00/ea
JOR194CCG	16g x 3"	\$46.00/ea
JOR194CDE	14g x 2"	\$55.00/ea
JOR194CDG	14g. x 3"	\$38.00/ea

BUY NOW



Straight Feeding Needle

Luerlock hub with stainless steel tube and nickel-plated silver ball on the end. Available in straight or curved. Specify type, gauge, and length when ordering.

JOR194SDH	14g x 4"	\$46.00/ea
-----------	----------	------------



Disposable Feeding Needle

Nylon luer hub accepts standard syringe. Sterile. 5/bag

- Soft silicone rubber covered tips
- Malleable shaft to any angle
- Sterile
- Luer hub

Jorvet

JOR194FA	20g x 1 1/2", 5 pk.	\$37.20/pk
JOR194FB	18g x 2", 5 pk	\$22.50/pk
JOR194FC	15g x 3", 5 pk	\$37.20/pk



Curved Needles, 2/pack

EJFNC10X4	10g x 4" 6.4mm Tip	\$37.03/pk
EJFNC12X25/8	12g x 2 5/8" Tip	\$27.48/pk
EJFNC12X4	12g x 4" 6.5mm Tip	\$23.63/pk
EJFNC12X4-ST	12g x 4" Tip	\$27.48/pk
EJFNC14X2	14g x 2" 4mm Tip	\$21.42/pk
EJFNC14X3	14g x 3" 4mm Tip	\$21.42/pk
EJFNC14X4	14g x 4" 4mm Tip	\$20.83/pk
EJFNC16X2	16g x 2" 3mm Tip	\$19.73/pk
EJFNC16X3	16g x 3" 3mm Tip	\$18.35/pk
EJFNC16X4	16g x 4" 3mm Tip	\$18.35/pk
EJFNC18X2	18g x 2" 2.4mm Tip	\$17.82/pk
EJFNC18X3	18g x 3" 2.4mm Tip	\$16.57/pk
EJFNC18X4	18g x 4" 2.4mm Tip	\$18.80/pk
EJFNC20X1.5	20g x 1.5" 4mm Tip	\$17.82/pk
EJFNC22X1.5	22g x 1.5" 2.4mm Tip	\$16.57/pk

Curved Needles, 3/pack

EJFNC-A	18g x 2", 14g x 3" - 3/PK	\$33.75/pk
EJFNC10X6	10g x 6" 6.4mm Tip	\$32.64/pk

BUY NOW



Jorvert Aluminum Hub Needles

Thunderbolt Aluminum Hub Hypodermic Needles have aluminum hubs with stainless steel needle cannulas and are especially designed for the demands of injecting large animals. The needles are razor sharp and individually packaged in their own disposable two-piece cartridges. Sterile, 100/pkg

Features:

- Color coded by gauge
- Marked with needle gauge and length
- Competitively priced



BUY NOW

Jorvet

Item#	Details	Price	Item#	Details	Price
AN14GX1.5	14g x 1.5", 100/bx	\$15.00/bx	AN16GX3/4	16g x 3/4", 100/bx	\$15.00/bx
AN14GX2	14g x 2", 100/bx	\$15.00/bx	AN16GX5/8	16g x 5/8", 100/bx	\$15.00/bx
AN14GX3/4	14g x 3/4", 100/bx	\$15.00/bx	AN18GX.75	18g x 3/4", 100/bx	\$15.00/bx
AN16GX1	16g x 1", 100/bx	\$15.00/bx	AN18GX1	18g x 1", 100/bx	\$15.00/bx
AN16GX1.5	16g x 1.5", 100/bx	\$15.00/bx	AN18GX1.5	18g x 1.5", 100/bx	\$15.00/bx
AN16GX2	16g x 2", 100/bx	\$15.00/bx	AN18GX2	18g x 2", 100/bx	\$15.00/bx
			AN20GX.5	20g x 1/2", 100/bx	\$15.00/bx

BUY NOW

Straight Needles, 2/pack

EJFNS10X4	10g x 4" 6.4mm Tip	\$32.64/pk
EJFNS10X6	10g x 6" 6.4mm Tip	\$32.64/pk
EJFNS12X25/8	12g x 2 5/8" Tip	\$24.22/pk
EJFNS12X4	12g x 4" 6.5mm Tip	\$24.22/pk
EJFNS12X4-ST	12g x 4" 4mm Tip	\$27.48/pk
EJFNS14X2	14g x 2" 4mm Tip	\$18.35/pk
EJFNS14X3	14g x 3" 4mm Tip	\$18.35/pk
EJFNS14X4	14g x 4" 4mm Tip	\$18.35/pk
EJFNS16X2	16g x 2" 3mm Tip	\$18.35/pk
EJFNS16X3	16g x 3" 3mm Tip	\$18.35/pk

Straight Needles, 2/pack

EJFNS16X4	16g x 4" 3mm Tip	\$18.35/pk
EJFNS18X2	18g x 2" 2.4mm Tip	\$18.80/pk
EJFNS18X3	18g x 3" 2.4mm Tip	\$18.80/pk
EJFNS18X4	18g x 4" 2.4mm Tip	\$18.80/pk
EJFNS20X1.5	20g x 1.5" 2.4mm	\$18.00/pk
EJFNS22X1.5	22g x 1.5" 2.4mm	\$16.57/pk

Straight Needles, 3/pack

EJFNS-A	18g x 2", 14g x 3", and 10" x 6" - 3/pk	\$38.28/pk
---------	---	------------

Syringes & Needles

JorVet Hypodermic Needles

Economy Hypodermic needles

Less expensive range of needles. Square hub with standard luer fit. Each needle imprinted with gauge size. 12/pkg.

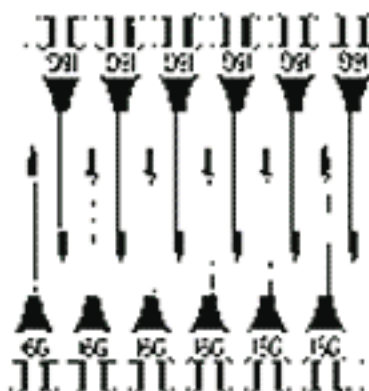

BUY NOW

JOR180BA	18g x 1/2", dz	\$5.70/dz
JOR180BB	18g x 3/4", dz	\$5.70/dz
JOR180BC	18g x 1", dz	\$5.70/dz
JOR180BD	18g x 1 1/2", dz	\$5.70/dz
JOR180BE	18g x 2", dz	\$5.55/dz
JOR180CA	16g x 1/2", dz	\$5.70/dz
JOR180CB	16g x 3/4" dz	\$5.70/dz
JOR180CC	16g x 1", dz	\$5.70/dz
JOR180CD	16g x 1 1/2", dz	\$5.70/dz
JOR180CE	16g x 2", dz	\$5.55/dz
JOR180CG	16g x 3", dz	\$5.55/dz
JOR180CH	16g x 4", dz	\$5.55/dz
JOR180DA	14g x 1/2", dz	\$5.70/dz
JOR180DB	14g x 3/4", dz	\$5.70/dz
JOR180DC	14g x 1", dz	\$5.70/dz
JOR180DD	14g x 1 1/2", dz	\$5.70/dz
JOR180DE	14g x 2", dz	\$5.55/dz
JOR180DG	14g x 3", dz	\$5.55/dz
JOR180DH	14g x 4", dz	\$5.55/dz

Stainless Steel Hypodermic Needle **JorVet**

Stainless steel. Round hub. Packaged in cardboard box or plastic clear case. 12/pkg.

BUY NOW

JOR174EC	12g x 1"	\$7.80/dz
JOR174ED	12g x 1 1/2"	\$7.80/dz
JOR174EE	12g x 2"	\$7.80/dz
JOR174EG	12g x 3"	\$8.10/dz
JOR174EH	12g x 4" dzn	\$9.30/dz
JOR174DB	14g x 3/4"	\$7.50/dz
JOR174DC	14g x 1"	\$7.50/dz
JOR174DD	14g x 1 1/2"	\$7.50/dz
JOR174DE	14g x 2"	\$7.50/dz
JOR174DG	14g x 3"	\$7.95/dz
JOR174DH	14g x 4"	\$8.10/dz
JOR174CA	16g x 1/2"	\$7.05/dz
JOR174CB	16g x 3/4"	\$7.05/dz
JOR174CC	16g x 1", 12/bx	\$7.05/dz
JOR174CD	16g x 1.5", 12/bx	\$7.05/dz
JOR174CE	16g x 2"	\$7.05/dz
JOR174CG	16g x 3"	\$7.65/dz
JOR174CH	16g x 4"	\$7.80/dz
JOR174BA	18g x 1/2"	\$6.75/dz
JOR174BB	18g x 3/4"	\$6.75/dz
JOR174BC	18g x 1", 12/bx	\$6.75/dz
JOR174BD	18g x 1.5", 12/bx	\$6.75/dz
JOR174BE	18g x 2"	\$6.75/dz
JOR174BG	18g x 3"	\$7.35/dz
JOR174BH	18g x 4"	\$7.65/dz
JOR174AA	20g x 1/2"	\$6.45/dz
JOR174AB	20g x 3/4"	\$6.45/dz
JOR174AC	20g x 1"	\$6.45/dz
JOR174AD	20g x 1 1/2"	\$6.45/dz
JOR174AE	20g x 2"	\$6.45/dz



JOR870 Series

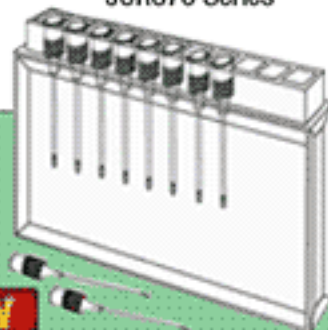

Hypodermic Needles

Premium Needles. German quality. Extra sharp reusable stainless steel. Round hub. Packaged in attractive clear plastic case. 10/pkg.

BUY NOW

14 Gauge

JOR870DA	14g x 1/2", 10pk	\$9.00/pk
JOR870DB	14g x 3/4", 10pk	\$9.00/pk
JOR870DC	14g x 1", 10pk	\$22.50/pk
JOR870DH	14g x 4", 10pk	\$16.50/pk

16 Gauge

JOR870CB	16g x 3/4", 10pk	\$19.50/pk
JOR870CC	16g x 1", 10p	\$19.50/pk
JOR870CG	16g x 3", 10pk	\$16.50/pk
JOR870CH	16g x 4", 10pk	\$13.50/pk

18 Gauge

JOR870BB	18g x 3/4", 10pk	\$9.00/pk
----------	------------------	-----------



JorVet

Syringes & Needles

JorVet Biopsy Needles



Franseen Style Biopsy Needle



Used to obtain core biopsy specimens for histology and impression smears. Attaches to standard syringe for aspiration. Cannula point design suitable for cutting difficult lesions. Also available in echogenic (ultrasound) tips. Sterile. Not autoclavable.



JOR526	Unmarked Needle. 18g x 9cm.t	\$19.80/ea
JOR526B	Unmarked Needle. 20g x 9cm.	\$15.30/ea
JOR526C	Unmarked Needle. 22g x 15cm.	\$15.30/ea

Franseen Style Biopsy Needle (Ultra Sound)

Used to obtain core biopsy specimens for histology and impression smears. Attaches to standard syringe for aspiration. Cannula point design suitable for cutting difficult lesions. Also available in echogenic (ultrasound) tips. Sterile. Not autoclavable.



JOR526EA	Marked Needle. 18g x 15cm.	\$16.50/ea
JOR526EC	Marked Needle. 20g x 15cm.	\$22.50/ea

Soft-Tissue Biopsy Needle



Long enough to reach any biopsy site. 1mm x 20mm specimen chamber.

JOR118	14g x 41/2" L shaft.	\$21.00/ea
--------	----------------------	------------



Rosenthal Bone Biopsy Needle

For use in bone marrow biopsy. Containing large spool luer lock hub, sharp pointed cannula and fitted stylet with matched bevel point. Autoclavable.



JOR116RA	18g x 1"	\$63.00/ea
JOR116RB	16g x 1 5/16"	\$63.00/ea



Vin-Silverman Biopsy Needle

For use in bone marrow biopsy. Containing large spool luer lock hub, sharp pointed cannula and fitted stylet with matched bevel point. Autoclavable.

JOR116VS	14g x 2 3/8".	\$194.00/ea
----------	---------------	-------------



FUS Needle

21g olive tipped needles are perfect for flushing of the small male feline urethra in cases of obstructive FLUTD. The blunt tip prevents trauma to the sensitive urethral lining. Rather than forcing struvite plugs back into the bladder with saline, it is suggested that JOR153w Walpole's solution is infused to dissolve away any crystal formation. Then a JOR153 series Jackson catheter is inserted to ensure urethral patency. Luer mount fits any syringe. Stainless steel. Autoclavable. Individually packaged.



JOR153C	21g x 1/2"	\$18.00/ea
JOR153D	21g x 1"	\$18.30/ea
JOR153E	21g x 1 1/2"	\$18.00/ea

True Cut Style Biopsy Needle

Long enough to reach any biopsy site. 1mm x 20mm specimen chamber.



JOR118A	18g x 10cm (4").	\$21.60/ea
JOR118B	18g x 10cm (4").	\$21.60/ea
JOR118C	18g x 10cm (4").	\$21.60/ea
JOR118D	18g x 10cm (4").	\$25.50/ea



Super Core Biopsy Needle



Sterile. Not autoclavable.

Features:

- Spring activated single handle operation
- Ideal lightweight design
- Echogenic tip for ultrasound visualization
- 20mm specimen notch
- Marked with cm graduations

JOR528	14g x 9cm	\$36.00/ea
JOR528A	16g x 9cm	\$36.00/ea
JOR528B	16g x 15cm	\$36.00/ea
JOR528C	18g x 9cm	\$36.00/ea



Osty Core Bone Biopsy Needle

For taking core samples of bone (i.e. suspected osteosarcoma). Sterile. Not autoclavable. NOTE: Not for bone marrow aspirates.

JOR116C	16g x 7.5cm (3").	\$55.50/ea
---------	-------------------	------------



Syringes & Needles

Jorvet Needles

Chiba Style Biopsy Needle Unmarked Needle)

General purpose aspiration biopsy needle. Short bevel removes sample from controlled area. Attaches to standard syringe. Small sizes for fine needle aspirates. Echogenic enhanced tip (ultrasound) available. Sterile. Not autoclavable. **Jorvet**

JOR527	18g x 9cm	\$12.60/ea
JOR527A	18g x 15cm	\$12.75/ea
JOR527AB	18g x 20cm, (8")	\$13.20/ea
JOR527B	20g x 9cm	\$14.40/ea
JOR527D	22g x 9cm	\$12.00/ea
JOR527E	22g x 15cm	\$14.40/ea



Jorvet Spinal Needles

Spinal Needle. General purpose aspiration biopsies and drainage procedures. Matched ground bevel eliminates possibility of tissue coring. Attaches to standard luer fitting. Available with echogenic enhanced tip (ultra-sound). Not autoclavable. Sterile.

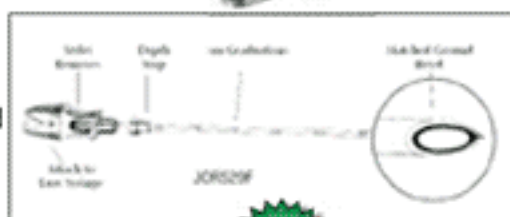

JOR529A	Unmarked Needle. 18g x 15cm (6")	\$12.00/ea
JOR529B	Unmarked Needle. 20g x 9cm (3 3/4")	\$10.50/ea
JOR529C	Unmarked Needle. 20g x 15cm (6")	\$10.50/ea
JOR529EB	Echogenic Tip.w/ultrasound tip. 20g x 9cm (33/4")	\$12.30/ea
JOR529ED	Echogenic Tip.w/ultrasound tip, 22g x 9cm	\$15.00/ea

Chiba Ultrasound Biopsy Needle, Echogenic Enhanced Tip (Ultrasound)

General purpose aspiration biopsy needle. Short bevel removes sample from controlled area. Attaches to standard syringe. Small sizes for fine needle aspirates. Echogenic enhanced tip (ultrasound) available. Sterile. Not autoclavable.

JOR527EA	18g x 15cm	\$14.40/ea
JOR527EB	20g x 9cm	\$16.50/ea
JOR527EC	20g x 15cm	\$15.75/ea
JOR527ED	22g x 9cm	\$16.50/ea



Jorvet Lateral Flow Vented Needle

JOR593	10/pk	\$10.50/ea
--------	-------	------------

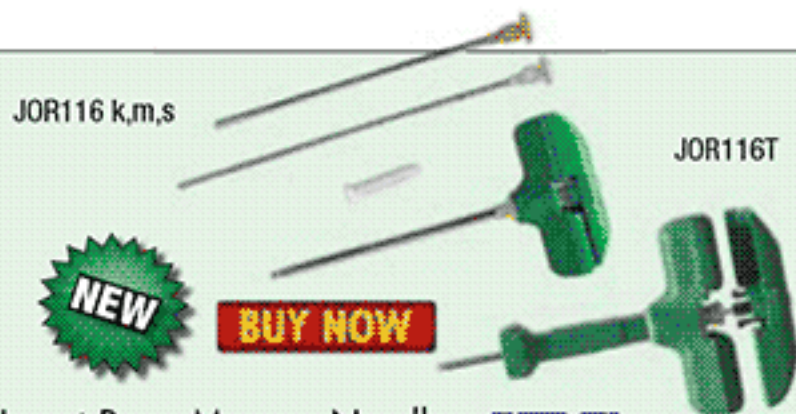

Jorvet Bone Marrow Needle **Jorvet**

Large hand grip for increased torque. Adjustable depth stop from 3/8" to 1 7/8" shaft. Luer lock syringe attachment. Similar to Jamshidi style. Can also be used for intraosseous fluid administration. Sterile. Green. Not autoclavable.

JOR116T	16 gauge, regular tip	\$21.00/ea
---------	-----------------------	------------

Bone Marrow Biopsy/Aspiration

These bone marrow needles allow for an actual biopsy versus the aspiration other needles provide. A special reamer is included to allow retrieval of actual tissue sample. Notice the difference in tip design, a double-side diamond. Not autoclavable. Sterile.

JOR116K	8g x 4"	\$40.50/ea
JOR116M	11g x 4"	\$40.50/ea
JOR116S	13g x 4" (reamer not included)	\$30.00/ea

Irrivet Wound Irrigation Syringe Kit

IRRIVET is a unique, spring-loaded, self-refilling system that quickly and easily irrigates contaminated wounds. Simple, one-hand, thumb-controlled pressure provides a forceful 7.6 psi stream directly to the desired area (or a gentler stream if needed). The soft flexible tip has an inside diameter equivalent to an 18-19 gauge needle. The soft, flexible 23/4" tip eliminates needlesticks for the user and minimizes trauma to the patient. Tip length can be trimmed. Concave Splatter-Gard™ prevents contamination from body secretions. The 6' tubing attaches to a standard IV bag.

JOR754	2 3/4" tip	\$22.80/ea
--------	------------	------------

BUY NOW

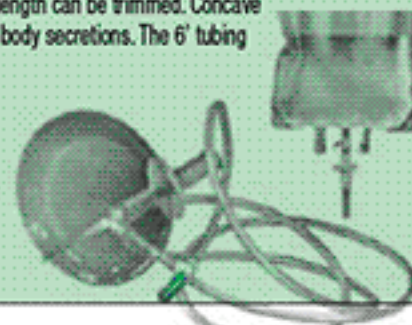

Intraosseous Infusion Needle

Intraosseous infusion is an excellent option when vascular access is difficult. Fluids and most IV drugs can be administered in this fashion. This method is mainly used in small animals and birds where blood vessels are small to begin with. The most common site of placement is the proximal femur. The point of entry for the canula is the trochanteric fossa. This method is for short time use and an IV catheter should be placed as soon as possible.

JOR116Q	Sterile, 12/pkg 18g x 3.5cm	\$19.80/ea
---------	-----------------------------	------------



Blunt End Needle, Jorgensen

Without olive tip. Stainless steel shaft and luer lock fitting.

JOR156D	23g x 1" (2.5cm)	\$9.00/ea
JOR156DS	30g x 1" (2.5cm)	\$13.20/ea

Special tip for easy insertion into lacrimal duct. Luer mount fits any syringe. Olive tip. Stainless steel.

JOR156DC	blunt tip, 23g, curved	\$12.00/ea
----------	------------------------	------------



Syringes & Needles

Jorvet Needles

BUY NOW

Thunderbolt Aluminum Hub Hypodermic Needles

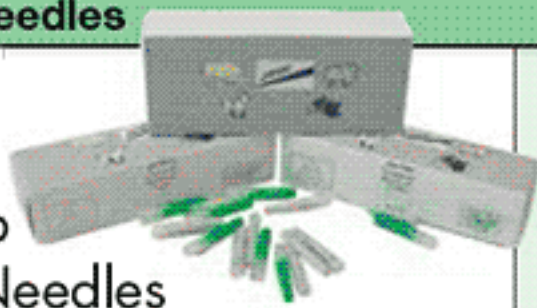

Aluminum hub hypodermic needles with stainless steel needle cannulas are especially designed for the demands of injecting large animals. The needles are razor sharp and individually packaged in their own disposable two-piece cartridges. Sterile. 100/pkg.

Features:

- Color coded by gauge
- Marked with needle gauge and length
- Competitively priced

JOR971	20g x 1/2"	\$15.75/bx
JOR972	20g x 1"	\$15.75/bx
JOR956	14g x 3/4"	\$15.75/bx
JOR965B	18g x 1/2"	\$15.75/bx



Loopuyt's Needle

BUY NOW

For taking core samples of bone (i.e. suspected osteosarcoma). Sterile. Not autoclavable.

JOR177A	#1, dozen	\$36.00/dz
JOR177B	#3, dozen	\$36.00/dz
JOR177C	#5, dozen	\$36.00/dz



Anal Sac Excision Kit

The anal sac excision kit employs a hot liquefied gel injected in to the sac. The gel is in a 2ml cartridge that is first boiled to a liquid and loaded in a specially designed syringe. Then, via a 19g blunt needle, is injected into each anal sac. The gel then hardens and gives the sac a readily defined and easily dissected shape for quick removal.

JOR101D3	\$12.60/pk
----------	------------

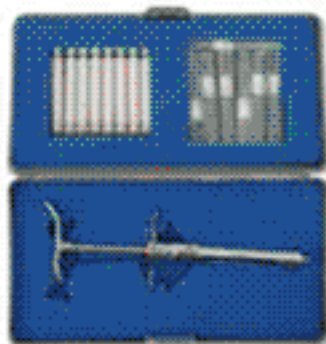

Blunt End Needle

BUY NOW

Blunt tip needles. These blunt end needles have a wide range of applications around the clinic including:

- Anal sac irrigation.
- Wound flushing.
- Lacrimal duct flush.
- Male cat urethral flush.
- Feeding needle.

These blunt ends have a polished straight stainless cannula with a polypropylene color-coded hub. Non-sterile 5 pack



JOR1033	15g x 1 1/2", Brown, 5pk	\$7.90/pk
JOR1033A	15g x 1/2", Brown, 5pk	\$5.90/pk
JOR1033B	18g x 1 1/2", Green, 5pk	\$5.90/pk
JOR1033C	18g x 1/2", Green, 5pk	\$5.90/pk
JOR1033D	20g x 1 1/2", Pink, 5pk	\$8.40/pk
JOR1033E	20g x 1/2", Pink, 5pk	\$8.40/pk
JOR1033F	25g x 1 1/2", Red, 5pk	\$5.90/pk
JOR1033G	25g x 1/2", Red, 5pk	\$5.90/pk



Blunt tip needles. **Straight but flexible.** Have a polypropylene burr free shaft with poly hub 5 pack non-sterile.

JOR1032	14g x 1 1/2", Green, 5pk	\$5.50/pk
JOR1032A	14g x 1", Green, 5pk	\$5.90/pk
JOR1032B	16g x 1 1/2", Gray, 5pk	\$6.90/pk
JOR1032C	16g x 1", Gray, 5pk	\$5.90/pk
JOR1032D	18g x 1 1/2", Green, 5pk	\$6.90/pk

JOR1032E	18g x 1", Green, 5pk	\$5.90/pk
JOR1032F	22g x 1 1/2", Blue, 5pk	\$6.30/pk
JOR1032G	22g x 1", Blue, 5pk	\$5.40/pk
JOR1032H	22g x 1/2", Blue, 5pk	\$4.75/pk

JOR1032J	25g x 1 1/2", Red, 5pk	\$5.60/pk
JOR1032K	25g x 1", Red, 5pk	\$6.15/pk
JOR1032M	25g x 1/2", Red, 5pk	\$5.25/pk
JOR1032N	30g x 1/2", Pink, 5pk	\$4.90/pk
JOR1032X	kit, 26 needles	\$26.00/set

Double End Transfer Needle

Double ended transfer needle. One end is a 1/2" 17g needle and the other end is a 1" x 19g needle. Sterile. The best choice for rehydrating solutions.

JOR173S	Sterile, 12/pkg.	\$21.75/dz
---------	------------------	------------



Transfer Needle Double Pointed

JOR173	Stainless steel, 16g x 1 1/4", 12/pkg.	\$43.50/dz
--------	--	------------



Transfer Needle

BUY NOW

has a concave metal plate where the finger can steady the transfer needle during mixing. Stainless steel. 14g x 3". Packaged in plastic vial.



JOR173T	Sterile, 12/pkg	\$0.92/pk
---------	-----------------	-----------

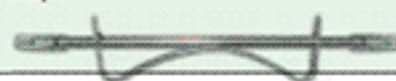

BUY NOW

Lacrimal Needle

Special tip for easy insertion into lacrimal duct. Luer mount fits any syringe. Olive tip. Stainless steel.

JOR156CA	Curved, 0.60mm x 30mm (~23g).	\$18.00/ea
JOR156A	Straight, 0.60mm x 30mm (~23g).	\$15.00/ea
JOR156F	Straight, 23g x 3/4" (~2cm) reinforced shaft 1/2" (1.3cm) extension.	\$15.00/ea



HI-TECH GERMAN SURGICAL INSTRUMENTS

LIFETIME WARRANTY

We guarantee every HI-TECH surgical instrument to be free of functional defects in workmanship and materials. HI-TECH promises to repair or replace, free of charge, any surgical instrument that does not meet these requirements when used for their intended surgical purpose.

HI-TECH promises to repair instruments that have been abused or subjected to abnormal use for a small surcharge.

Warranty Applies to Hi-Tech German Instruments only not Jorgensen German Instruments

CARE AND HANDLING

With proper care and handling, HI-TECH instruments will last for years. Please use these guidelines for all HI-TECH stainless steel instruments.

- Brand new instruments should be cleaned prior to first sterilization.
- Contaminated instruments should be processed as soon as possible.
- Stubborn protein particles can be removed with a scrub brush. Never use steel wool, abrasives or an acid rinse.
- Open joints on instruments prior to preparation
- Do not use multipurpose detergents to wash or soak instruments. Instead, use a low-suds detergent specifically designed for instruments. (re-order #LSD) The pH of the product should never be higher than 8.
- When using ultrasonics, a detergent with a pH of either 6, 7 or 8 must be used.
- Lubrication is vital to a long instrument life. We recommend a water soluble instrument milk (re-order #ILG)
- Avoid silicone lubricants because they tend to build up and mix with debris to clog moving parts, which becomes almost impossible to remove.
- Debris buildup can have a "rust-like" appearance.
- Rinse your cleaned instruments in demineralized water. Be sure to remove all residual cleaning compounds before sterilization, as they can cause stains.
- Dry the instrument thoroughly after rinsing.

INSTRUMENT CHECK-UP

The best time to check your instruments is after they have been cleaned, lubricated, and have cooled off.

Please check the following:

1. FUNCTION:

Splitters, nippers and scissors must cut cleanly (resharpen if needed) and close properly.

Needle holders and clamps must engage properly and meet correctly at the tips.

Instruments which have been dropped or otherwise damaged should be inspected carefully for cracking, bent tips or breakage.

2. SURFACE:

Inspect the surface for any signs of staining or other irregularity. If you find any staining, investigate the source and avoid it in the future.

SOME COMMON SOURCES OF STAINING ARE:

Inadequate cleaning, mixing dissimilar metals, water impurities, unsuitable or improper preparation and usage of cleaning and disinfecting or maintenance agents, Non-Compliance with operating procedures of cleaning and sterilizing equipment.

Storage

Allow instruments to dry thoroughly before storing them in a clean, dry environment. Never store them in an area where chemicals may emit corrosive vapors or where temperature and moisture variations may cause condensation on the instruments.

Quick Checklist

1. Rinse soiled instruments immediately. Thoroughly clean before autoclaving.
2. Autoclave and sterilize instruments in an open position.
3. Do not pile up or entangle instruments.
4. Follow the recommendations of the equipment and solution manufacturers.
5. Keep instruments properly lubricated.
6. Inspect instruments regularly.

Instrument Care & Protection Guide

The high grade instruments you own represent a considerable investment. The following guide will help you protect this investment and should enable you to receive many years of use from your instruments. All Hi-Tech German, stainless steel, surgical instruments are made of corrosion resistant, high grade, specialty steels which can meet the varying requirements of cutting, clamping, retracting, chiseling, etc. One of the special characteristics of these steels is that they form passive layers on the surface which protects against corrosion. These layers can be thought of as an invisible patina. With repeated use and exposure to the air, this oxidation process continues, making the instrument even more corrosion resistant with proper maintenance. However, a word of caution is in order: While every effort is made in the manufacturing process to make the instruments corrosion resistant, you must do your part by treating them properly. If not, the steel can rust or stain, reducing the life of the instrument or even rendering it useless. In a sense, the word "stainless" is a misnomer and should not be taken literally. Later in this guide we will discuss the most common problems encountered with instrument maintenance.

Proper Usage

Instruments are designed for a particular purpose and they should be used for only that purpose. It is important to choose the proper instrument for the task to be accomplished. For instance, a nail splitter should not be used to cut wire.

Water

Because tap water contains many minerals which may cause discoloration and staining, we recommend the use of distilled water for cleaning, disinfecting, sterilizing and rinsing instruments. To avoid staining, use a cleaning solution with a pH near neutral (7). If you do use tap water for rinsing, please make sure you dry the instrument thoroughly to avoid stains.

Brand New Instruments

Newly purchased instruments must be cleaned, lubricated and autoclaved before use.

Manual Cleaning

When handling instruments be very careful not to damage their fine tip and mechanisms. If instruments have been exposed to blood, tissue, saline or other foreign matter, you must rinse them in warm (not hot) water before these substances are allowed to dry. After rinsing, immerse them in a cleaning solution. A number of compounds, such as certain chemicals, are highly corrosive to stainless steel. To be on the safe side, rinse and dry instruments immediately in case they have come in contact with any potentially harmful substances. If no ultrasonic cleaner is available, clean the instrument very carefully. Pay particular attention when cleaning the box locks, serrations, hinges and all other hard to reach areas. Use nylon (not steel) brushes (such as a toothbrush), and warm (not hot) cleaning solutions.

Follow the manufacturer's instruction for preparation of cleaning solutions. Change these solutions daily!

Ultrasonic Cleaning

This is by far the most effective and most efficient way to clean your instruments. Follow the manufacturer's recommendation for mixing the solution and the duration of the cleaning cycle.

Before putting soiled instruments into an ultrasonic cleaner, we recommend that they be cleaned in a cleaning solution, of all visible debris clinging to them.

Please observe the following:

1. Do not mix dissimilar metals (like chrome and stainless) in the same cycle.
2. Open all instruments so ratchets and box locks are accessible.
3. When loading, avoid piling instruments on top of each other. This could damage delicate instruments.
4. After the cycle is finished, remove the instruments, rinse and dry them off immediately.
5. Also allow them to air dry thoroughly.

Lubrication and Autoclaving

Remember, autoclaving is no substitute for cleaning. If the instruments are not thoroughly cleaned beforehand, irreparable damage may occur during the autoclaving process. Before autoclaving, lubricate all instruments with moving parts, such as box locks and hinges. Use instrument milk or surgical lubricants, not industrial oils. Always sterilize instruments in an open or unlocked position. DO NOT overload the chamber and be sure to stack the instruments carefully so no damage occurs to the delicate instruments.

It is recommended that the instruments be wrapped in cloth inside the container or that a cloth be placed on the bottom of the pan to absorb moisture. The cloth should be pH (7) neutral and have no residue of detergents. During and after the drying cycle, avoid cooling the instrument suddenly. This can happen when a rush of cold air enters the autoclave chamber or when the hot instruments are placed on a cool, metal surface. If this happens, condensation can occur which may result in the staining of the instruments.

Cold Sterilization and Disinfection

Prolonged immersion in disinfection or sterilization solution can be detrimental to surgical instruments. We recommend that you do not immerse the instruments longer than twenty minutes. To render the instruments sterile and ready for use, we recommend the use of an autoclave cycle. This saves time and is more gentle to the instruments. Rinse and dry instruments thoroughly after disinfection.

GERMAN SPAY PACKS

LIFETIME WARRANTY*



The Canine Spay Pack includes 18 stainless steel instruments.
Available in three grades: Economy, Hi-Tech and Integra/Integra/Miltex.

- 1 Mayo Scissors 6 3/4" straight
- 1 #3 Scalpel/Blade Handle
- 1 Snook Hook 8"
- 2 Kelly Hemostat Forceps 5 1/2" curved
- 1 Metzenbaum Scissor, 5 1/2" curved
- 1 Tissue Forceps, 5 1/2", 1 x 2 teeth
- 4 Backhaus Towel Forceps 3 1/2"
- 1 Olsen-Hegar Needle Holder 6 1/2"
- 1 Adson-Brown Forceps 4 3/4" 7x7
- 1 Allis Forceps 6" 4x5
- 2 Halstead Mosquito Forceps, 5" curved
- 2 Rochester-Carmalt Forceps, 6.25" curved

HI-TECH
FINEST QUALITY
GERMAN SURGICAL
INSTRUMENTS

*German
Instruments Only

BUY NOW

Canine Spay Pack

CSPAY-GER	18 Instruments	\$291.99/ea	GERMAN WITH LIFETIME WARRANTY
CSPAY-ECON	18 Instruments	\$39.95/ea	ECONOMY
CSPAY-MIL	18 Instruments	\$904.97/ea	Integra/Miltex WITH LIFETIME WARRANTY

The Feline Spay Pack includes 18 stainless steel instruments.
Available in three grades: Economy, Hi-Tech and Integra/Miltex.

- 1 Mayo Scissors 6 3/4" straight
- 1 #3 Scalpel/Blade Handle
- 1 Snook Hook 8", Small End 4mm
- 2 Kelly Hemostat Forceps 5 1/2" curved
- 1 Metzenbaum Scissor, 5 1/2" curved
- 1 Tissue Forceps, 5 1/2", 1 x 2 teeth
- 4 Backhaus Towel Forceps 3 1/2"
- 1 Olsen-Hegar Needle Holder 5 1/2"
- 1 Adson-Brown Forceps 4 3/4" 7x7
- 1 Allis Forceps 6" 4x5
- 2 Halstead Mosquito Forceps, 5" curved
- 2 Rochester-Carmalt Forceps, 6.25" curved

HI-TECH
FINEST QUALITY
GERMAN SURGICAL
INSTRUMENTS

*German
Instruments Only

BUY NOW

Feline Spay Pack

FSPAY-GER	18 Instruments	\$291.99/ea	GERMAN WITH LIFETIME WARRANTY
FSPAY-ECON	18 Instruments	\$39.95/ea	ECONOMY
FSPAY-MIL	18 Instruments	\$899.00/ea	Integra/Miltex WITH LIFETIME WARRANTY

SEE THE END OF THIS SECTION For A Full Assortment
Of Genral and Specialized Instrument Packs

13822 WEST BOULTON BLVD. METTAWA, IL 60045

Phone 800-544-7521

73

WWW.SHOPMEDVET.COM

Fax 800-204-2177

Instruments

Surgical Blades & Handles

Stainless Steel Surgical Blades

Vendor	Item#	Details	Price
Various	10SS	#10, 100/bx	\$16.00/bx
	11SS	#11, 100/bx	\$16.00/bx
	12SS	#12, 100/bx	\$16.00/bx
	15SS	#15, 100/bx	\$16.00/bx
	20SS	#20, 100/bx	\$16.00/bx
	21SS	#21, 100/bx	\$16.00/bx
	22SS	#22, 100/bx	\$16.00/bx
	23SS	#23, 100/bx	\$16.00/bx
	24SS	#24, 100/bx	\$16.00/bx

JORGENSEN	JOR580S	#10, 100-pk	\$15.40/bx
	JOR581S	#11, 100-pk	\$15.40/bx
	JOR582S	#12, 100-pk	\$15.40/bx
	JOR583S	#15, 100-pk	\$15.40/bx
	JOR584S	#20, 100-pk	\$15.40/bx
	JOR585S	#21, 100-pk	\$15.40/bx
	JOR586S	#22, 100-pk	\$15.40/bx

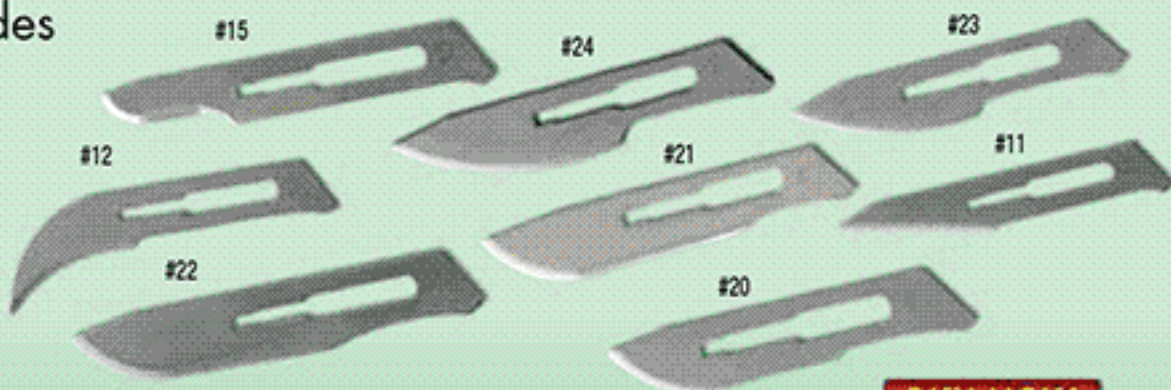

Carbon Steel Surgical Blades

Item#	Details	Price	Item#	Details	Price
#10	#10, 100/bx	\$13.00/bx	#20	#20, 100/bx	\$13.00/bx
#11	#11, 100/bx	\$13.00/bx	#21	#21, 100/bx	\$13.00/bx
#12	#12, 100/bx	\$13.00/bx	#22	#22, 100/bx	\$13.00/bx
#15	#15, 100/bx	\$13.00/bx	#23	#23, 100/bx	\$13.00/bx
			#24	#24, 100/bx	\$13.00/bx

BUY NOW

Chisel Blades

#312	12/bx	\$9.95/bx
#313	12/bx	\$9.95/bx
#314	12/bx	\$9.95/bx
#316	12/bx	\$9.95/bx

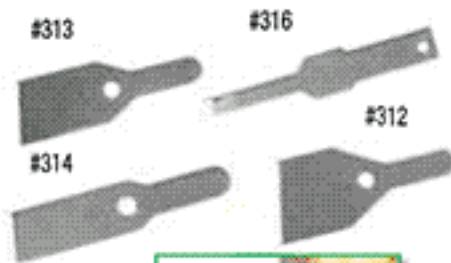

BUY NOW

Micro Scalpel Blades

Vendor	Item#	Details	Price
SWANN-MORTON	JOR890	Handle Only, 25/bx	\$13.50/ea
	JOR891	#64 Micro Scalpel Blade, 25 pk	\$52.00/ea
	JOR891A	#65 Micro Scalpel Blade, 25/pk	\$52.00/ea
	JOR891AXS	#65 blades (extra small #11), 25/pk	\$62.00/ea



BUY NOW

Mini Blades

Vendor	Details	Price
ECONOMY	#6100 12/bx	\$9.95/bx
	#6200 12/bx	\$9.95/bx
	#6400 12/bx	\$9.95/bx
	#6700 12/bx	\$9.95/bx



BUY NOW

Scalpel Handles

RULER ON INTEGRA/MILTEX ONLY!

Vendor	Item#	Details	Price
ECONOMY	6-450	#3, fits blades #10-#15	\$1.50/ea
	6-455	#4, fits blades #20-#24	\$2.00/ea
	6-460	#7, fits blades #10-#15	\$3.00/ea
	6-460-S	#7, Satin Finish	\$6.00/ea
MID GRADE			
GERMAN	06-100	#3, 5" graduated in mm and cm	\$6.49/ea
	06-102	#4, 5.25", with graduated mm and cm markings	\$6.49/ea
	06-104	#7, 6.5", fits blades 10-15	\$10.99/ea
JORGENSEN	JOR55A	Size 3	\$2.60/ea
	JOR55B	Size 4	\$3.00/ea
	JOR55GA	German-made, Size #3	\$6.90/ea
	JOR55GB	German-made, Size #4	\$6.90/ea
INTEGRA/MILTEX	MIL4-7	#3, fits blades #10-#15	\$18.30/ea
	MIL4-8	#4, fits blades #20-#24	\$18.77/ea
	MIL4-9	#7, fits blades #10-#15	\$29.95/ea

JOR55A

JOR55B

NEW

Mini and Chisel Blade Handles

Vendor	Item#	Details	Price
ECONOMY	#13	4"	\$9.95/ea
	#13L	5.25"	\$9.95/ea
	#14P	4.25"	\$9.95/ea
GERMAN	36-100	10cm	\$18.00/ea
	36-101	6.25"	\$12.00/ea



Plastic Scalpel Handle

Vendor	Item#	Details	Price
JORGENSEN	JOR55PA	Size #3	\$4.20/ea
	JOR55PB	Size #4	\$4.20/ea



Folding Scalpel Handle

Vendor	Item#	Details	Price
JORGENSEN	JOR55FA	Size #3	\$6.00/ea
	JOR55FFB	Size #4	\$6.00/ea

BUY NOW



Disposable Scalpels & Suture Needles

Disposable Scalpels

BUY NOW

Vendor	Item#	Details	Price
Economy	DS10	#10, 10/bx	\$7.00/bx
	DS11	#11, 10/bx	\$7.00/bx
	DS12	#12, 10/bx	\$7.00/bx
	DS15	#15, 10/bx	\$7.00/bx
	DS20	#20, 10/bx	\$7.00/bx
	DS21	#21, 10/bx	\$7.00/bx

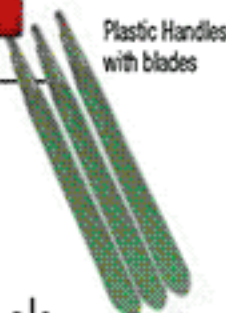

Disposable Stainless Steel Scalpels (Stainless Steel)

Jorvet

Vendor	Item#	Details	Price
JORGENSEN	JOR580	#10, 10-pk	\$7.50/bx
	JOR581	#11, 10-pk	\$7.50/bx
	JOR582	#12, 10-pk	\$7.50/bx
	JOR583	#15, 10-pk	\$7.50/bx
	JOR584	#20, 10-pk	\$7.50/bx
	JOR585	#21, 10-pk	\$7.50/bx
	JOR586	#22, 10-pk	\$7.50/bx



Swann-Morton Disposable Scalpel

Vendor	Item#	Details	Price
JORGENSEN	JOR55DA	size #10, 10/box	\$9.90/bx
	JOR55DB	size #11, 10/box	\$9.90/bx
	JOR55DC	size #12, 10/box	\$9.90/bx
	JOR55DD	size #15, 10/box	\$9.90/bx
	JOR55DE	size #20, 10/box	\$9.90/bx
	JOR55DF	size #21, 10/box	\$9.90/bx
	JOR55DG	size #22, 10/box	\$9.90/bx



Reverse Cutting Suture Needles

BUY NOW

Choose from a full selection of needles for all veterinary needs. Sizes available include 2, 4, 6, 8, 10, 11, 12, 13, 14, 16, 18 and 20 in 3/8-circle & 1/2 Reverse Circle models. 12/pk. Price is for (1) 12/PK OF ONE size only. Please specify size when ordering.

3/8" Circle			1/2" Circle		
JOR7011-2	size 2, 55mm	\$9.30dz	JOR7031-11	size 11, 25mm	\$9.30dz
JOR7011-4	size 4, 49mm	\$9.30dz	JOR7031-2	size 2, 45mm	\$9.30dz
JOR7011-6	size 6, 43mm	\$9.30dz	JOR7031-4	size 4, 45mm	\$9.30dz
JOR7011-8	size 8, 39mm	\$9.30dz	JOR7031-6	size 6, 35mm	\$9.30dz
JOR7011-10	size 10, 33mm	\$9.30dz	JOR7031-8	size 8, 29mm	\$9.30dz
JOR7011-11	size 11, 31mm	\$9.30dz	JOR7031-10	size 10, 26mm	\$9.30dz
JOR7011-12	size 12, 28mm	\$9.30dz	JOR7031-12	size 12, 23mm	\$9.30dz
JOR7011-14	size 14, 25mm	\$9.30dz	JOR7031-13	size 13, 22mm	\$9.30dz
JOR7011-16	size 16, 22mm	\$9.30dz	JOR7031-14	size 14, 19mm	\$9.30dz
JOR7011-18	size 18, 20mm	\$9.30dz	JOR7031-16	size 16, 17mm	\$9.30dz
JOR7011-20	size 20, 17mm	\$9.30dz	JOR7031-18	size 18, 15mm	\$9.30dz

JOR7031XL 3/8-circle. 3 1/4". Extra heavy needles for bovine and equine use. 12/pk. **\$36.00pk**

Taper Suture Needles

Choose from a full selection of needles for all veterinary needs. Sizes available include 2, 4, 6, 8, 10, 11, 12, 13, 14, 16, 18 and 20 in 3/8- & 1/2 Taper Circle. Models 12/pk. Price is for (1) 12/PK OF ONE size only. Please specify size when ordering.

3/8" Circle			1/2" Circle		
JOR6017-2	size 2, 55mm	\$9.30dz	JOR6037-2	size 2, 45mm	\$9.30dz
JOR6017-4	size 4, 49mm	\$9.30dz	JOR6037-4	size 4, 40mm	\$9.30dz
JOR6017-6	size 6, 22mm	\$9.30dz	JOR6037-6	size 6, 35mm	\$9.30dz
JOR6017-8	size 8, 39mm	\$9.30dz	JOR6037-8	size 8, 29mm	\$9.30dz
JOR6017-10	size 10, 33mm	\$9.30dz	JOR6037-10	size 10, 26mm	\$9.30dz
JOR6017-12	size 12, 28mm	\$9.30dz	JOR6037-12	size 12, 23mm	\$9.30dz
JOR6017-14	size 14, 25mm	\$9.30dz	JOR6037-14	size 14, 25mm	\$9.30dz
JOR6017-16	size 16, 22mm	\$9.30dz	JOR6037-16	size 16, 17mm	\$9.30dz
JOR6017-18	size 18, 20mm	\$9.30dz	JOR6037-18	size 18, 13mm	\$9.30dz
JOR6017-20	size 20, 17mm	\$9.30dz	JOR6037-20	size 20, 13mm	\$9.30dz

JOR6037XL 3/8-circle. 3 1/4". Extra heavy needles for bovine and equine use. 12/pk. **\$30.00pk**

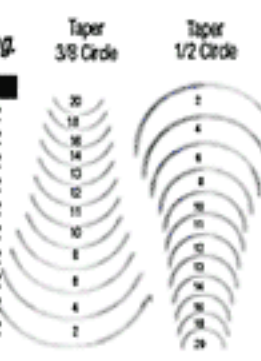
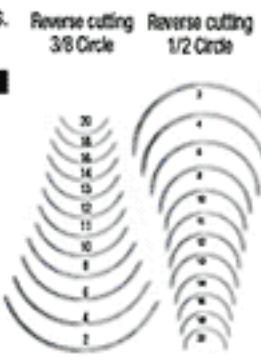

Needle Rack

Jorvet

BUY NOW



Convenient spring action model for holding suture needles.
JOR105R \$15.00/ea



Needle Sterilization Rack

Item# MIL3-50
Details Rack
Price \$29.62/ea

MILTEX



Blade-Safe Surgical Blade Remover

Vendor **INTEGRA/MILTEX** Item# MIL4-100 Details safely removes blades from handles, protecting hands Price \$24.40/ea



INTEGRA Millex Suture Needles

1/2 Circle Taper Point Needle

Regular Surgeon's Needles, 1/2 circle, taper point

MIL-192A-10	Size 10, 35mm, 12/pk	\$47.04 /Pk
MIL-192A-12	Size 12, 29mm, 12/pk	\$47.04 /Pk
MIL-192A-14	Size 14, 24mm, 12/pk	\$47.04 /Pk
MIL-192A-16	Size 16, 22mm, 12/pk	\$47.04 /Pk
MIL-192A-18	Size 18, 18mm, 12/pk	\$47.04 /Pk
MIL-192A-20	Size 20, 13mm, 12/pk	\$47.04 /Pk

Starburst graphic with 'NEW' and 'Please specify size when ordering.'



1/2 Circle Cutting Edge Needle

Regular Surgeon's Needles, 1/2 circle, cutting edge

MIL-192-10	Size 10, 35mm, 12/pk	\$50.96 /Pk
MIL-192-12	Size 12, 29mm, 12/pk	\$50.96 /Pk
MIL-192-14	Size 14, 24mm, 12/pk	\$50.96 /Pk
MIL-192-16	Size 16, 22mm, 12/pk	\$50.96 /Pk
MIL-192-18	Size 18, 18mm, 12/pk	\$50.96 /Pk
MIL-192-20	Size 20, 13mm, 12/pk	\$50.96 /Pk

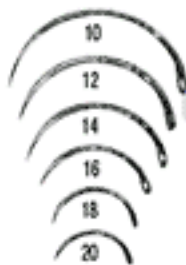

3/8 Circle Taper Point Needle

Regular Surgeon's Needles, 3/8 circle, round body, taper point

MIL-140A-10	Size 10, 35mm, 12/pk	\$47.04 /Pk
MIL-140A-12	Size 12, 29mm, 12/pk	\$47.04 /Pk
MIL-140A-14	Size 14, 24mm, 12/pk	\$47.04 /Pk
MIL-140A-16	Size 16, 22mm, 12/pk	\$47.04 /Pk
MIL-140A-18	Size 18, 18mm, 12/pk	\$47.04 /Pk
MIL-140A-20	Size 20, 13mm, 12/pk	\$47.04 /Pk



3/8 Circle Cutting Edge Needle

Regular Surgeon's Needles, 3/8 circle, cutting edge, reverse cutting

MIL-140-10	Size 10, 35mm, 12/pk	\$41.16/Pk
MIL-140-12	Size 12, 29mm, 12/pk	\$41.16/Pk
MIL-140-14	Size 14, 24mm, 12/pk	\$41.16/Pk
MIL-140-16	Size 16, 22mm, 12/pk	\$41.16/Pk
MIL-140-18	Size 18, 18mm, 12/pk	\$41.16/Pk
MIL-140-20	Size 20, 13mm, 12/pk	\$41.16/Pk



INTEGRA Millex
Needle Sizes

10	12	14	16	18	20
35mm	29mm	24mm	22mm	18mm	13mm

Instruments

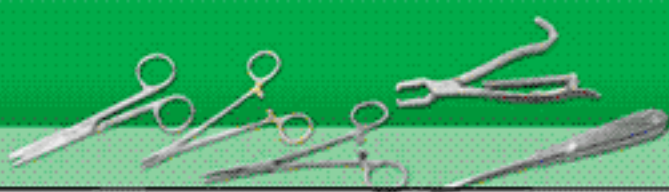

Needles and Needle Holders

BUY NOW

Aesculap Mayo Hegar Needle Holder



Vendor	Item#	Details	Price
JORGENSEN	JOR661	Tungsten Carbide Inserts, Gold-plated Rings, Combination Scissors, 5 1/2"	\$105.00/ea
	JOR661A	Tungsten Carbide Inserts, Gold-plated Rings, 6 1/2"	\$114.00/ea

Aesculap Olsen Hegar Needle Holder (w/Scissors)



Vendor	Item#	Details	Price
JORGENSEN	JOR660	Tungsten Carbide Inserts, Gold-plated Rings, Combination Scissors, 5 1/2"	\$132.00/ea
	JOR660A	Tungsten Carbide Inserts, Gold-plated Rings, Combination Scissors, 6 1/2"	\$135.00/ea

Baumgartner Needle Holder

BUY NOW



Vendor	Item#	Details	Price
Economy	11-1195	5"	\$3.95/ea
MID GRADE	11-1195-S	5", Satin Finish	\$6.95/ea
German	12-105	5.25"	\$25.00/ea
INTEGRA/MILTEX	MIL8-40	5.25"	\$95.17/ea

Crile Wood Needle Holder

BUY NOW



Vendor	Item#	Details	Price
German	12-113	6"	\$35.00/ea
	12-114	8"	\$35.00/ea
Economy	4-534	6"	\$2.95/ea
JORGENSEN	JOR78X	Tungsten Carbide Jaws, 6" (15cm)	\$53.00/ea

Castroviejo Needle Holder

Jorvet



Vendor	Item#	Details	Price
JORGENSEN	JOR231	5 1/2", Economy	\$90.00/ea
	JOR231E	5 1/2", Economy	\$54.00/ea

Keith Needle

BUY NOW

Triangular cutting point

Vendor	Item#	Price
JORGENSEN	JOR7050A	\$5.40/pk
	JOR7050B	\$5.40/pk
	JOR7050C	\$5.40/pk
	JOR7050D	\$5.40/pk
	JOR7050E	\$5.40/pk
	JOR7050E	\$9.00/pk



Derf Needle Holder

Vendor	Item#	Details	Price
Economy	11-1200	4.75"	\$3.95/ea
MID GRADE	11-1200-S	4.75", Satin Finish	\$6.95/ea
German	12-100	4.75"	\$24.00/ea
INTEGRA/MILTEX	MIL8-4	4 3/4", w/Scissors	\$94.45/ea
	MIL8-4TC	4.75" Tungsten Carbide	\$189.97/ea

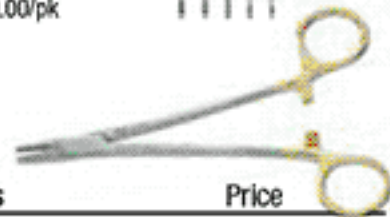

Halsey Needle Holder

BUY NOW

Vendor	Item#	Details	Price
German	12-152	5" Smooth Jaw	\$59.00/ea
	12-153	5", Smooth Jaw Tungsten Carbide	\$59.00/ea
INTEGRA/MILTEX	MIL8-8TC	5", Tungsten Carbide	\$189.97/ea



Masson Needle Holder

BUY NOW

Vendor	Item#	Details	Price
JORGENSEN	JOR78M	Masson Needle Holder	\$48.00/ea



Mathieu Needle Holder

BUY NOW

Vendor	Item#	Details	Price
German	12-119	5.5"	\$40.00/ea
	12-120	6.25" With Spring Handles	\$40.00/ea
JORGENSEN	JOR80	Economy, 7"	\$15.60/ea
	JOR80WT	German, Tungsten Carbide Jaws, 6 1/2"	\$90.00/ea
	JOR80WTH	Heavy Duty, Tungsten Carbide Jaws, 8"	\$155.00/ea

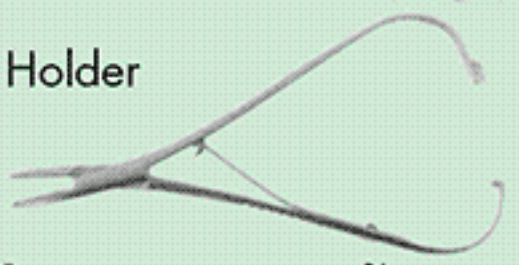

Needle Holders



Mayo Hegar Needle Holder

BUY NOW



Vendor	Item#	Details	Price
Economy	11-1225	8"	\$4.95/ea
	11-1205	5"	\$3.95/ea
	11-1215	6"	\$3.95/ea
	11-1220	7"	\$4.95/ea
	German	12-161	5.5" Tungsten Carbide
12-162		6" Tungsten Carbide	\$55.00/ea
12-163		7" Tungsten Carbide	\$55.00/ea
12-106		5.5"	\$24.00/ea
12-107		6"	\$24.00/ea
12-108		7"	\$24.00/ea
12-110		8"	\$24.00/ea
INTEGRA/MILTEX		MIL8-46TC	7" Tungsten Carbide
	MIL8-42	5"	\$84.04/ea
	MIL8-44	6"	\$85.49/ea
	MIL8-46	7"	\$94.15/ea
	MIL8-44TC	6" Tungsten Carbide	\$192.74/ea
JORGENSEN	JOR78A	Economy, Stainless steel, 6"	\$8.00/ea
	JOR78B	Economy, Stainless steel, 7"	\$10.00/ea
	JOR78WTA	German, Tungsten Carbide Jaws, 6"	\$96.00/ea
	JOR78WTB	German, Tungsten Carbide Jaws, 7"	\$84.00/ea

Olsen Hegar Needle Holder (with Scissors)

BUY NOW



Vendor	Item#	Details	Price
ECONOMY	11-1231	7.5, w/Scissors	\$5.95/ea
	11-1230	5.5", w/Scissors	\$5.95/ea
	11-1235	6.5", w/Scissors	\$5.95/ea
	OHTC5.5	5.5" Tungsten Carbide, w/Scissors	\$35.00/ea
	OHTC6.5	6.5" Tungsten Carbide, w/Scissors	\$27.95/ea
	OHTC7.5	7.5" Tungsten Carbide, w/Scissors	\$42.00/ea
GERMAN	12-195	5", Tungsten Carbide	\$60.00/ea
	12-118	7.25", w/Scissors	\$35.00/ea
	12-116	5.5" (with scissors)	\$35.00/ea
	12-117	6.5", w/Scissors	\$35.00/ea
	12-196	5.5" Tungsten Carbide (with scissors)	\$60.00/ea
	12-197	6.5" Tungsten Carbide (with scissors)	\$60.00/ea
	12-198	7.5" Tungsten Carbide	\$60.00/ea
	MID-GRADE	11-1205-S	5", Satin Finish
11-1230-S		5.5", Satin Finish, w/Scissors	\$7.95/ea
11-1215-S		6" Satin Finish	\$6.95/ea
11-1235-S		6.5", Satin Finish, w/Scissors	\$7.95/ea
11-1231-S		7.5", Satin Finish, w/Scissors	\$7.95/ea
11-1225-S		8", Satin Finish	\$7.95/ea
INTEGRA/MILTEX	MIL8-15TC	5.5" Tungsten Carbide, w/Scissors	\$241.44/ea
	MIL8-16TC	6.5" Tungsten Carbide, w/Scissors	\$249.11/ea
	MIL8-17TC	7.5" Tungsten Carbide, w/Scissors	\$277.32/ea
	MIL8-15	5.5", w/Scissors	\$146.97/ea
	MIL8-16	6.5", w/Scissors	\$154.84/ea
	MIL8-17	7.5", w/Scissors	\$180.70/ea
	JORGENSEN	JOR79A	Economy, 6", w/Scissors
JOR79B		Economy, 7", w/Scissors	\$13.60/ea
JOR79WTA		Tungsten Carbide Jaws, 5 1/2", w/Scissors	\$96.00/ea
JOR79WTB		Tungsten Carbide Jaws, 6 1/2", w/Scissors	\$99.00/ea
JOR79WTD		Tungsten Carbide Jaws, 7 1/2", w/Scissors	\$102.00/ea

SEE OUR DENTAL & LARGE ANIMAL SECTION FOR MORE INSTRUMENTS!

Webster Needle Holder

BUY NOW

Vendor	Item#	Details	Price
Economy	11-1250	5"	\$2.95/ea
	11-1250	5"	\$2.95/ea
	11-1251	6"	\$2.95/ea
MID GRADE	11-1250-S	5", Satin Finish	\$5.95/ea
	11-1251-S	Economy, 6" Satin	\$5.95/ea



Vendor	Item#	Details	Price
GERMAN	12-102	4.75"	\$24.00/ea
	12-151	5" Smooth Jaw, Tungsten Carbide	\$59.00/ea
INTEGRA/MILTEX	MIL8-6	5" Smooth	\$94.45/ea



Forceps



Adson Dressing Forceps



BUY NOW

Vendor	Item#	Details	Price
<i>Economy</i>	7-905	4.75"	\$1.95/ea
<i>German</i>	15-120	4.75"	\$16.00/ea
<i>INTEGRA/MILTEX</i>	MIL6-118	4.75"	\$50.19/ea
	MIL6-123	For Suture, 1 X 2 teeth, 4-3/4" (12.1 cm), with tying platform	\$117.85/ea
<i>JORGENSEN</i>	JOR92BX	4 3/4" (12cm).	\$3.60/ea
	JOR92BXW	German, 4 3/4" (12cm).	\$14.25/ea
<i>MID GRADE</i>	7-905-S	4.75",Satin Finish	\$4.95/ea

Adson Tissue Forceps



BUY NOW

FULL SIZE

Vendor	Item#	Details	Price
<i>ECONOMY</i>	8-950	4.5", 1x2 teeth	\$1.95/ea
<i>GERMAN</i>	15-124	4.75", 1x2 teeth	\$13.00/ea
	15-129	4.75", 2x3 teeth	\$21.50/ea
<i>INTEGRA/MILTEX</i>	MIL6-120	4.75", 1x2 teeth	\$53.35/ea
	MIL6-121	4.75", 1x2 teeth W/Serrated Tips	\$56.59/ea
<i>JORGENSEN</i>	JOR92Q	Economy, 1 x 2 teeth. 4 3/4", Small delicate	\$14.75/ea
	JOR92QW	German, 1 x 2 teeth. 4 3/4", Small delicate (12cm)	\$13.50/ea
<i>MID GRADE</i>	8-950-S	1X2 Teeth,4.5", Satin Finish	\$4.95/ea

Brown Forceps



BUY NOW

Vendor	Item#	Details	Price
<i>ECONOMY</i>	8-955	4.75", 9x9 teeth	\$3.95/ea
<i>MID GRADE</i>	8-955-S	9X9 Teeth, 4.75",Satin Finish	\$6.95/ea
<i>GERMAN</i>	15-125	4.75", 7x7 teeth	\$24.00/ea
	JOR92BA	4 1/2", 7 x 8 teeth	\$31.50/ea
<i>INTEGRA/MILTEX</i>	MIL6-124	4.75", 7x7 teeth	\$72.55/ea

Allis Tissue Forceps



BUY NOW

Vendor	Item#	Details	Price
<i>ECONOMY</i>	10-1005	5.5", 2x3 teeth	\$2.95/ea
<i>MID-GRADE</i>	10-1000	6", 4x5 Teeth	\$3.10/ea
	10-1000-S	4X5 Teeth,6", Satin Finish	\$5.99/ea
<i>GERMAN</i>	17-108	6", 5x6 Teeth	\$20.00/ea
	17-106	6", 4x5 Teeth	\$20.00/ea
	17-104	6", 3x4 Teeth	\$30.00/ea
	17-110	7", 5x6 Teeth	\$20.00/ea
<i>INTEGRA/MILTEX</i>	MIL16-6	6", 4x5 teeth	\$84.06/ea
	MIL16-8	6", 5x6 Teeth	\$84.06/ea
<i>JORGENSEN</i>	JOR80A	Economy, 6"	\$8.00/ea
	JOR80AW	German, 6"	\$27.00/ea
	JOR80B	Economy, 7"	\$9.60/ea

Alligator Forceps



Vendor	Item#	Details	Price
<i>JORGENSEN</i>	JOR93A	3 1/2" Shaft	\$28.50/ea
	JOR93B	5 1/2" Shaft	\$39.00/ea
	JOR93C	8" Shaft	\$54.00/ea
	JOR93D	12" Shaft	\$63.00/ea
	JOR93BW	5 1/2" Shaft	\$69.00/ea

BUY NOW

Extraction Alligator Forceps



Vendor	Item#	Details	Price
<i>JORGENSEN</i>	JOR93E	21" Shaft	\$140.00/ea

Hartman Alligator Forceps



Vendor	Item#	Details	Price
<i>ECONOMY</i>	10-1105	3.5"	\$24.00/ea
	10-1110	5.5"	\$24.00/ea
<i>GERMAN</i>	21-147	5.5"	\$60.00/ea

Babcock Forceps



BUY NOW

Vendor	Item#	Details	Price
<i>ECONOMY</i>	7-160	8.25"	\$11.00/ea

Baby Mixer Forceps

Jorvet

Vendor	Item#	Details	Price
<i>INTEGRA/MILTEX</i>	MIL7-210	5-1/4" (13.3 cm), fully curved, extra delicate	\$119.69/ea

BUY NOW

Bishop-Harmon Forceps

Jorvet



Vendor	Item#	Details	Price
<i>GERMAN</i>	13-111	Micro Tissue, 1x2 teeth, 3.5"	\$30.00/ea
	13-110	dressing, 3.5"	\$30.00/ea

Beasley Babcock forceps

Vendor	Item#	Price
<i>JORGENSEN</i>	JOR92W	\$15.00/ea

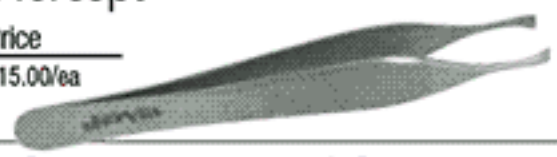

Forceps

Bennett Cilia Forceps



Vendor	Item#	Details	Price
INTEGRA/MILTEX	MIL18-1112	3" CJT SHAPED JAWS, 3MM DIA.	\$242.90/ea

Bozeman Hemostat Forceps

Vendor	Item#	Details	Price
GERMAN	12-233	10.5" Curved	\$29.00/ea

Bovine Forceps



Vendor	Item#	Details	Price
JORGENSEN	JOR15C	Stainless Steel, 12"	\$52.00/ea

Castroviejo Fixation Forceps



Vendor	Item#	Details	Price
JORGENSEN	JOR232E	Economy, 1 x 1 teeth, 3 1/2"	\$24.00/ea
	JOR232	For suturing the cornea. 1 x 1 delicate teeth.-made. 3 1/2".	\$89.00/ea

Crile Forceps

BUY NOW

Vendor	Item#	Details	Price
ECONOMY	4-530	5.5" Straight	\$2.95/ea
	4-531	5.5" Curved	\$2.95/ea
	4-532	6.25" Straight	\$2.95/ea
	4-533	6.25" Curved	\$2.95/ea
MID GRADE	4-530-S	5.5", Straight, Satin Finish	\$5.95/ea
	4-531-S	5.5", Curved, Satin Finish	\$5.95/ea
	4-532-S	6.25", Straight Satin Finish	\$5.95/ea
	4-533-S	6.25", Curved, Satin Finish	\$5.95/ea
JORGENSEN	JOR72C	Economy, Curved, 6"	\$6.20/ea
	JOR72S	Economy, Straight, 6"	\$6.00/ea
	JOR72CW	German, Curved, 6"	\$25.00/ea
	JOR72SW	German, Straight, 6"	\$24.00/ea
GERMAN	07-113	5.5" Straight	\$16.00/ea
	07-114	5.5" Curved	\$16.00/ea
	07-115	6.25" Straight	\$16.00/ea
	07-116	6.25" Curved	\$16.00/ea
INTEGRA/MILTEX	MIL7-42	5.5" Straight	\$57.56/ea
	MIL7-44	5.5" Curved	\$58.24/ea

Crile-Rankin Forceps

BUY NOW

Vendor	Item#	Details	Price
GERMAN	13-183	6.25" Straight	\$18.00/ea
	13-184	6.25" Curved	\$18.00/ea

Carmalt Forceps

Jorvat

Vendor	Item#	Details	Price
JORGENSEN	JOR83C	Economy, Curved 6 1/4"	\$10.00/ea
	JOR83S	Economy, Straight, 6 1/4"	\$10.00/ea
	JOR83CW	German, Curved, 6 1/4"	\$31.00/ea
	JOR83SW	German, Straight, 6 1/4"	\$31.00/ea

Debakey Y Vascular Tissue Forceps

Vendor	Item#	Details	Price
JORGENSEN	JOR92DV	1.5mm tips, 6" (15cm).	\$46.00/ea
INTEGRA/MILTEX	MIL24-572	8" (20.3 cm), 1.5 mm wide jaws	\$228.56/ea/ea

DEBAKEY Thoracic Tissue Forceps

Vendor	Item#	Details	Price
INTEGRA/MILTEX	MIL24-552	7 1/2", (19.7 cm), 2.5 mm wide jaws	\$216.78/ea

Desmarres-Chalazion Forceps

BUY NOW

Vendor	Item#	Details	Price
GERMAN	20-145	11 x 17mm	\$80.00/ea
	20-147	12 x 23mm	\$80.00/ea
	20-149	17 x 28mm	\$80.00/ea

Doyen Forceps

Vendor	Item#	Details	Price
ECONOMY	7-131	9" Straight	\$9.29/ea
	7-132	9" Curved	\$9.29/ea
GERMAN	17-130	9" Straight	\$48.00/ea
	17-132	9" Curved	\$32.00/ea
JORGENSEN	JOR135C	Excellent for ear cropping, Curved, 4" jaws. Stainless steel, 9".	\$22.50/ea
	JOR135S	Straight	\$22.50/ea
MILTEX	MIL16-160	9" Straight	\$337.11/ea

Instruments

Forceps

Esophageal Foreign Body Forceps

Jorvet

Vendor	Item#	Details	Price
JORGENSEN	JOR212EFB	25cm shaft x 3.0mm diameter	\$160.00/ea
	JOR212EFA	50cm shaft x 4.2mm diameter	\$180.00/ea
	JOR212EF	50cm shaft x 7.5mm/6mm diameter. Extra long forceps (83cm or 29" long shafts). Diameter jaws 13mm x 9mm. Maximum jaw gap is 30mm.	\$165.00/ea

BUY NOW

Extracting Forceps

Vendor	Item#	Details	Price
GERMAN	V-307A	7", Universal Root Forceps	\$48.00/ea
	V-307B	7", Splitter/Seperator Forceps	\$48.00/ea
	V-307C	7", Incisor/Bicuspid Forceps	\$48.00/ea
	V-307D	7", Molar/Extractor Forceps	\$48.00/ea

BUY NOW

Eye Dressing Forceps

Vendor	Item#	Details	Price
ECONOMY	10-1025	4" Straight	\$2.95/ea
	10-1030	4" 1/2 Curved	\$2.95/ea
	10-1035	4" Full curved	\$2.95/ea
MID GRADE	10-1025-S	4", Straight Satin Finish	\$5.95/ea
	10-1030-S	4", 1/2 Curved Satin Finish	\$5.95/ea
	10-1035-S	4", Curved, Satin Finish	\$5.95/ea
GERMAN	15-145	4" Straight, Serrated	\$14.00/ea
	15-146	4.5" Curved, Half Curved, Serrated	\$14.00/ea
	15-147	Eye Dressing Forceps Full Curved Standard 4"	\$14.00/ea
INTEGRA/MILTEX	MIL18-780	4" Straight	\$47.98/ea
	MIL18-782	4" 1/2 Curved	\$49.51/ea
	MIL18-784	4" Full Curved	\$49.36/ea

Ferguson Angiotribe Forceps

Vendor	Item#	Details	Price
GERMAN	07-156	6.25" Straight	\$48.00/ea
	07-157	6.25" Curved	\$48.00/ea
	07-158	7.5" Straight	\$48.00/ea
	07-159	7.5" Curved	\$48.00/ea
JORGENSEN	JOR73C	Curved, Economy, 7"	\$13.80/ea
	JOR73CW	Curved, 6 1/2" (16.5cm)	\$123.00/ea
	JOR73S	Economy, Straight, 7"	\$14.50/ea
BUY NOW	JOR73SW	German, Straight, 6 1/2" (16.5cm)	\$87.00/ea

Feilchenfeld Splinter Forceps

Vendor	Item#	Details	Price
MID GRADE	16-105-S	3", Satin Finish	\$12.00/ea
GERMAN	16-105	3"	\$9.00/ea

Feline Declaw Forceps

Vendor	Item#	Details	Price
JORGENSEN	JOR1026	Stainless Steel, 4"	\$36.00/ea
	JOR1026A	Stainless Steel, 5 1/4"	\$36.00/ea

Forester Sponge Forceps

Vendor	Item#	Details	Price
ECONOMY	6-840	9.5"	\$6.95/ea
MID GRADE	6-840-S	9.5", Satin Finish	\$9.95/ea
GERMAN	09-106	9.5"	\$32.00/ea
INTEGRA/MILTEX	MIL7-600	9-1/2" (24.1 cm), straight, serrated jaws	\$87.66/ea

Graefe Iris Forceps

Vendor	Item#	Details	Price
JORGENSEN	JOR231GC	Serrated, Curved, 4"	\$9.00/ea
	JOR231GS	Straight 4"	\$9.00/ea

Halsted Mosquito Forceps

Vendor	Item#	Details	Price
INTEGRA/MILTEX	MIL7-10	Curved, Extra Delicate	\$76.15/ea

Iris Forceps

Vendor	Item#	Details	Price
MID GRADE	10-1040-S	1X2 Teeth, 4", Straight Satin Finish	\$5.95/ea
	10-1045-S	1X2 Teeth, 4 1/2", Curved, Satin Finish	\$5.95/ea

Jones Artery Forcep

Vendor	Item#	Details	Price
JORGENSEN	JOR95	5"	\$5.70/ea

Forceps

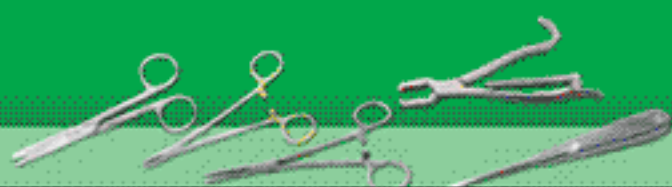

Jewelers Forceps

BUY NOW

Vendor	Item#	Details	Price
GERMAN	10-557	#5 super fine, 4 3/8"	\$15.00/ea
	10-558	#6	\$15.00/ea
	10-559	#7	\$15.00/ea
INTEGRA/MILTEX	MIL17-306	#6	\$68.22/ea



Kantrowitz Thoracic Forceps

BUY NOW

Vendor	Item#	Details	Price
INTEGRA/MILTEX	MILMH25-836	7 1/2" (19.1 cm), delicate right angle jaws	\$99.67/dz

Kelly Forceps

BUY NOW

Vendor	Item#	Details	Price
ECONOMY	4-520	5.5" Straight	\$2.95/ea
	4-521	5.5" Curved	\$2.95/ea
	4-522	6.25" Straight	\$2.95/ea
	4-523	6.25" Curved	\$2.95/ea
	4-560	8.5" Straight	\$2.95/ea
MID GRADE	4-520-S	5.5", Straight, Satin Finish	\$5.95/ea
	4-521-S	5.5", Curved, Satin Finish	\$5.95/ea
JORGENSEN	JOR71C	Curved, 5 1/2"	\$5.30/ea
	JOR71CW	German, Curved, 5 1/2"	\$24.00/ea
	JOR71SW	German, Straight, 5 1/2"	\$24.00/ea
	JOR71S	Straight, 5 1/2"	\$5.30/ea
GERMAN	07-109	5.5" Straight	\$16.00/ea
	07-110	5.5" Curved	\$16.00/ea
	07-111	6.25" Straight	\$16.00/ea
	07-112	5.5" Curved	\$16.00/ea
INTEGRA/MILTEX	MIL7-36	5.5" Straight	\$56.30/ea
	MIL7-38	5.5" Curved	\$58.93/ea



Kelly-Rankin Forceps

BUY NOW

Vendor	Item#	Details	Price
GERMAN	07-108	6.25" Curved	\$18.00/ea



Littauer Forceps

BUY NOW

Vendor	Item#	Details	Price
GERMAN	21-223	3.5"	\$12.00/ea
INTEGRA/MILTEX	MIL18-1100	3.5"	\$33.90/ea



Lucae Forceps

Jorvet



Vendor	Item#	Details	Price
JORGENSEN	JOR92X	5 3/4" (14cm).	\$15.00/ea



McLean OB Forceps

Jorvet

Vendor	Item#	Details	Price
JORGENSEN	JOR22H	8" L.	\$36.00/ea



Michel Forceps

NEW

Can be used both for applying and removing Michel clips. Stainless steel. 12cm. 100 clips/rack.

BUY NOW

Vendor	Item#	Details	Price
MID GRADE	5-960-S	5", Satin Finish	\$9.95/ea

Vendor	Item#	Details	Price
INTEGRA/MILTEX	MIL17-2510	4-3/4" (12.1 cm), serrated jaws, 0.5 mm wide	\$70.73/ea



Magill Forceps

BUY NOW

Vendor	Item#	Details	Price
JORGENSEN	JOR631C	Large	\$15.00/ea
	JOR631B	Medium	\$15.00/ea
	JOR631A	Small	\$15.00/ea



Lesser Suture Retrieval Forceps

Vendor	Item#	Price
JORGENSEN	JOR1066	\$123.00/ea





Mosquito Forceps

BUY NOW

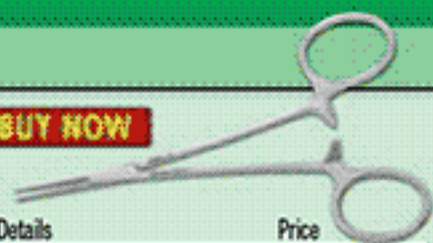

Vendor	Item#	Details	Price
ECONOMY	4-500	3.5" Straight	\$2.95/ea
	4-501	3.5" Curved	\$2.95/ea
	4-510	5-5.5" Straight	\$2.95/ea
	4-511	5-5.5" Curved	\$2.95/ea
GERMAN	07-100	3.5" Straight	\$15.00/ea
	07-101	3.5" Curved	\$15.00/ea
	07-102	5" Straight	\$16.00/ea
	07-104	5" Curved	\$16.00/ea
MID GRADE	4-500-S	3.5", Straight, Satin Finish	\$5.95/ea
	4-501-S	3.5", Curved Satin Finish	\$5.95/ea
	4-510-S	5-5.5", Straight, Satin Finish	\$5.95/ea
	4-511-S	5-5.5", Curved Satin Finish	\$5.95/ea
JORGENSEN	JOR70C	Economy, Curved, 5"	\$5.30/ea
	JOR70S	Economy, Straight, 5"	\$5.30/ea
	JOR70CW	German, Curved, 5"	\$27.00/ea
	JOR70SW	German, Straight, 5"	\$27.00/ea
INTEGRA/MILTEX	MIL7-2	5" Straight	\$55.74/ea
	MIL7-24	3.5" Straight	\$65.03/ea
	MIL7-26	3.5" Curved	\$67.13/ea
	MIL7-4	5" Curved	\$57.30/ea
	MIL7-8	5" Straight Delicate	\$74.47/ea

Jorvet Pig OB Forcep

BUY NOW

Danish model. These forceps open sideways, making it practically impossible to catch the uterine lining. The piglet is gently grasped either around the head or the hips. No need of inserting your hand to place the instrument.



Vendor	Item#	Details	Price
JORGENSEN	JOR22	23" L.	\$25.50/ea

Jorvet Puppy OB Forceps

BUY NOW

Stainless steel. Same design as JOR22.

Vendor	Item#	Details	Price
JORGENSEN	JOR22A	Stainless Steel, 8" L.	\$14.25/ea

Jorvet Nylon Forceps

NOTE: Not intended for everyday surgical use. These instruments are useful for a variety of clinical uses at a very affordable price. These instruments will come in handy for a lot of non surgical procedures.

- Autoclavable
- Will not rust
- Very inexpensive
- Non-repairable

Jorvet

BUY NOW

Nylon Hemostat Forceps

Vendor	Item#	Details	Price
JORGENSEN	JOR579H	5"	\$2.25/ea

Nylon Sponge Forceps

Vendor	Item#	Details	Price
JORGENSEN	JOR579S	8"	\$3.00/ea

Nylon Thumb Forceps

Vendor	Item#	Details	Price
JORGENSEN	JOR579T	4 1/2"	\$3.30/ea

Nylon Towel Clamp

Vendor	Item#	Details	Price
JORGENSEN	JOR579C		\$3.30/ea

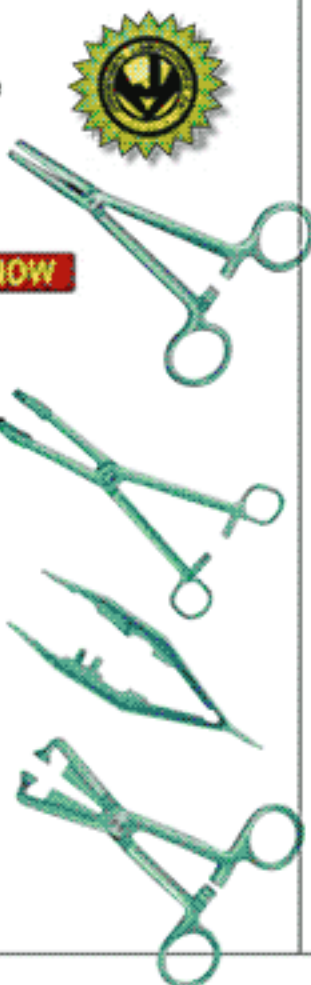

Pierse Colibri Type Corneal Forceps

BUY NOW



Vendor	Item#	Details	Price
INTEGRA/MILTEX	MIL18-880	3-1/4", TIPS 0.12mm	\$488.08/ea

Rochester-Carmalt Forceps

BUY NOW



Vendor	Item#	Details	Price
ECONOMY	4-540	6.25" Straight	\$4.95/ea
	4-541	6.25" Curved	\$4.95/ea
	4-542	8" Straight	\$5.95/ea
	4-543	8" Curved	\$5.95/ea
MID GRADE	4-540-S	6.25", Straight, Satin Finish ⁶	\$7.95/ea
	4-541-S	6.25", Curved, Satin Finish ⁶	\$7.95/ea
	4-542-S	8", Straight, Satin Finish ⁶	\$8.95/ea
	4-543-S	8", Curved, Satin Finish ⁶	\$8.95/ea
GERMAN	07-137	6.25" Straight	\$29.00/ea
	07-138	6.25" Curved	\$29.00/ea
	07-139	8" Straight	\$29.00/ea
	07-140	8" Curved	\$29.00/ea
INTEGRA/MILTEX	MIL7-170	6.25" Straight	\$98.05/ea
	MIL7-172	6.25" Curved	\$102.35/ea
	MIL7-180	8" Straight	\$153.42/ea
	MIL7-182	8" Curved	\$161.29/ea



Forceps

Rochester-Ochsner Forceps



BUY NOW

Vendor	Item#	Details	Price
ECONOMY	4-482	7.25" Straight	\$3.95/ea
	4-580	6.25" Straight	\$3.95/ea
	4-584	8" Straight	\$3.95/ea
	4-586	6.25" Curved	\$3.95/ea
	4-588	7.25" Curved	\$3.95/ea
	4-590	8" Curved	\$3.95/ea
JORGENSEN	JOR72R0	Curved, Economy, 1 x 2 teeth at tip. 6 1/4" (16cm).	\$7.50/ea
	JOR72R0W	Curved, 1 x 2 teeth at tip. 6 1/4" (16cm).	\$28.50/ea
	JOR72RS	Straight, Economy, 1 x 2 teeth at tip. 6 1/4" (16cm).	\$7.50/ea
	JOR72RSW	Straight, 1 x 2 teeth at tip. 6 1/4" (16cm).	\$30.00/ea
MID GRADE	4-580-S	6.25", Straight Satin Finish	\$6.95/ea
	4-586-S	6.25", Curved Satin Finish	\$6.95/ea
GERMAN	07-141	5.5" Curved	\$18.00/ea
	07-142	6.25" Curved	\$18.00/ea
	07-143	7.25" Curved	\$18.00/ea
	07-144	6.25" Straight	\$18.00/ea
	07-145	7.25" Straight	\$18.00/ea
	07-146	8" Curved	\$25.00/ea
	07-147	5.5", Straight	\$18.00/ea
	07-149	8" Straight	\$18.00/ea
	07-150	10", Curved	\$39.00/ea
	INTEGRA/MILTEX	MIL7-154	8" Straight

Splinter Forceps



BUY NOW

Vendor	Item#	Details	Price
ECONOMY	8-900	4.5"	\$2.95/ea
MID GRADE	8-900-S	4.5", Satin Finish	\$5.95/ea
GERMAN	16-112	4.5" Straight	\$15.00/ea
	16-115	5.5"	\$18.00/ea
INTEGRA/MILTEX	MIL6-304	4.5"	\$24.63/ea

Sterilizer Forceps



BUY NOW

Vendor	Item#	Details	Price
ECONOMY	11-1185	8"	\$30.00/ea
GERMAN	10-104	8"	\$24.00/ea

Swiss Tweezer Forceps

Vendor	Item#	Details	Price
GERMAN	36-109	#1 fine, 4 3/4"	\$9.00/ea
	36-110	#2 strong fine, 4 3/4"	\$9.00/ea
	36-111	#4 fine, 4 3/8"	\$9.00/ea
	36-112	#5 super-fine, 4 3/8"	\$22.00/ea
	36-113	#6, 4 1/2"	\$9.00/ea
	36-114	#7, fine, curved 4 1/2"	\$17.00/ea



Rochester-Pean Forceps



BUY NOW

Vendor	Item#	Details	Price
ECONOMY	4-552	7.5" Curved	\$11.00/ea
	4-554	7-8" Straight	\$4.95/ea
GERMAN	07-119	6.25" Straight	\$29.00/ea
	07-120	6.25" Curved	\$29.00/ea
	07-123	8" Straight	\$29.00/ea
	07-124	8" Curved	\$29.00/ea
	07-125	9" Curved	\$29.00/ea
MILTEX	MIL7-138	6.25" Curved	\$72.38/ea

Sponge Forceps

BUY NOW

Vendor	Item#	Details	Price
JORGENSEN	JOR85	9 1/2"	\$6.90/ea

Skin Staple Removing Forceps

Vendor	Item#	Details	Price
INTEGRA/MILTEX	MIL9-62	5 1/2" (14 cm)	\$219.61/dz

Tissue Forceps

BUY NOW

Vendor	Item#	Details	Price
INTEGRA/MILTEX	MIL6-46	standard pattern serrated handles, 6" (15.2 cm)	\$30.24/ea

Iris Tissue Forceps

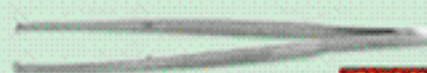

BUY NOW

Vendor	Item#	Details	Price
ECONOMY	10-1040	4", 1x2 teeth Straight	\$2.95/ea
	10-1045	4", 1x2 teeth 1/2 Curved	\$2.95/ea
	10-1050	4", 1x2 teeth Curved	\$2.95/ea
MID GRADE	10-1040-S	1X2 Teeth, 4", Straight Satin Finish	\$5.95/ea
	10-1050-S	1X2 Teeth, 4" Curved Satin Finish	\$5.95/ea
GERMAN	15-150	4" Straight, Standard 1x2 Teeth	\$14.00/ea
	15-151	4" Half Curved, Standard 1x2 Teeth	\$14.00/ea

Russian Tissue Forcep

BUY NOW

Vendor	Item#	Details	Price
ECONOMY	8-960	6"	\$3.95/ea
	8-965	8"	\$3.95/ea
JORGENSEN	JOR92R		\$7.50/ea
MID GRADE	8-960-S	6", Economy,	\$6.95/ea
		Satin Finish	
GERMAN	15-110	6"	\$12.00/ea
INTEGRA/MILTEX	MIL6-142	6"	\$51.16/ea



Forceps & Clamps

Tissue Forceps

BUY NOW

Vendor	Item#	Details	Price
JORGENSEN	JOR92	5 1/2"	\$2.10/ea
	JOR92TB	2 x 3 teeth Economy, 5 1/2"	\$4.05/ea
	JOR92TBW	2 x 3 Teeth, 5 1/2"	\$9.90/ea
	JOR92TCW	3 x 4 Teeth, 5 1/2"	\$13.50/ea
	JOR92TC	3 x 4 Teeth, Economy, 5 1/2"	\$4.50/ea
	JOR92TD	4 x 5 Teeth Economy, 5 1/2"	\$4.50/ea
	JOR92TA	Economy, 1 x 2 teeth	\$2.70/ea
	JOR92TAW	German, 1 x 2 teeth	\$7.50/ea



Thumb Tissue Forceps

BUY NOW

Vendor	Item#	Details	Price
ECONOMY	8-920	5-5.5", 1x2 teeth	\$1.95/ea
	8-925	6-6.5", 1x2 teeth	\$1.95/ea
MID GRADE	8-920-S	1 X 2 Teeth, 5-5.5", Satin Finish	\$4.95/ea
	8-925-S	1X2 Teeth, 6-6.5", Satin Finish	\$4.95/ea
GERMAN	14-104	5.5", 1x2 teeth	\$12.00/ea
	14-122	5.5", 2x3 teeth	\$12.00/ea
	14-132	5.5", 3x4 teeth	\$12.00/ea
INTEGRA/MILTEX	MIL6-42	5", 1x2 teeth	\$25.48/ea



Thumb Dressing Forceps

BUY NOW

Vendor	Item#	Details	Price
ECONOMY	7-855	4.5"	\$1.95/ea
	7-865	5.5"	\$1.95/ea
	7-880	8"	\$3.95/ea
MID GRADE	7-855-S	4.5", Satin Finish	\$4.95/ea
	7-865-S	5.5", Satin Finish	\$4.95/ea
	7-880-S	8", Satin Finish	\$4.95/ea
GERMAN	13-106	5.5"	\$9.00/ea
INTEGRA/MILTEX	MIL6-6	5"	\$23.14/ea
	MIL6-8	5.5"	\$23.73/ea



Young Tongue Seizing Forceps

BUY NOW

Vendor	Item#	Details	Price
GERMAN	33-287	6.25"	\$39.00/ea
JORGENSEN	JOR895	Stainless Steel, 6 3/4" (17cm) L.	\$16.50/ea

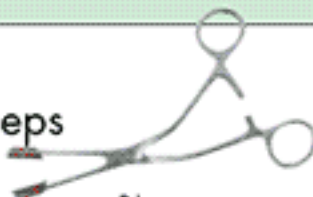

Verbrugge Forceps

Vendor	Item#	Details	Price
JORGENSEN	JOR213VA	6.5"	\$192.00/ea
	JOR213VB	9.5"	\$226.00/ea



BUY NOW

Backhaus Towel Clamps

BUY NOW

Vendor	Item#	Details	Price
ECONOMY	5-805	3.5"	\$3.95/ea
	5-806	5.5"	\$3.95/ea
MID GRADE	5-805-S	3.5", Satin Finish	\$6.95/ea
	5-806-S	5.5", Satin Finish	\$6.95/ea
GERMAN	11-100	3.5"	\$14.00/ea
	11-101	5.25"	\$14.00/ea
INTEGRA/MILTEX	MIL7-504	3.5"	\$51.89/ea
	MIL7-506	5.25"	\$53.67/ea



Baby Doyen Intestinal Clamp

JorVet BUY NOW

Vendor	Item#	Details	Price
JORGENSEN	JOR135CW	18cm cvd, 61/2" flexible blade with diagonal serrations.	\$117.00/ea
	JOR135SW	18cm cvd, 61/2" flexible blade with diagonal serrations.	\$110.00/ea

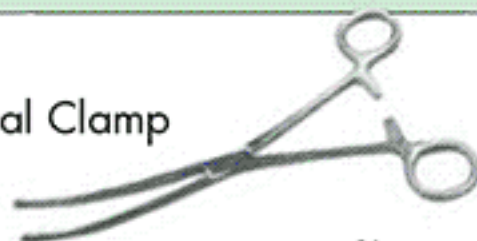

Backhaus Towel Clamp

Vendor	Item#	Details	Price
JORGENSEN	JOR81S	Economy with stops (Roeder). 5 1/2".	\$6.90/ea
	JOR81A	Economy. 3 1/2"	\$5.00/ea
	JOR81B	Economy. 5 1/2".	\$5.40/ea
BUY NOW	JOR81AW	German, 3 1/2"	\$20.80/ea
	JOR81BW	German, 5 1/2"	\$22.80/ea
	JOR81WS	German-Made with stops (Roeder). 5 1/2".	\$26.00/ea



Condyle Clamp

An improvement over the old style rectangular plexi-glass condyle clamp. This triangular, stainless steel, two-sided clamp fits over the humeral condyles and allows greater alignment. A lag screw can be inserted through the hole in the middle of the triangular plate. Reduction may be checked by radiography prior to lag screw fixation. Pressure should be applied proximo-laterally not just purely laterally.

Vendor	Item#	Price
JORGENSEN	JOR213C	\$106.00/ea



BUY NOW

DeBakey Vascular Clamp

Vendor	Item#	Details	Price
JORGENSEN	JOR72DV	Slightly Curved 7.5cm L jaw, Stainless steel., 23cm Stainless steel., 23cm	\$270.00/ea



BUY NOW

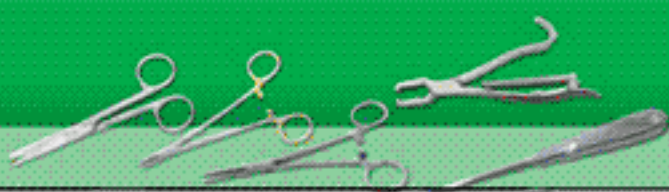

Clamps

Breed Specific Ear Trim Clamp

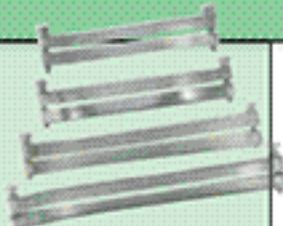

JorVet BUY NOW

Vendor	Item#	Details	Price
JORGENSEN	JOR49MCv	Doberman Pattern, 15 cm. 6"	\$39.00/ea
	JOR49MB	Boxer Pattern, 13.5cm. 5.4"	\$39.00/ea
	JOR49MD	Great Dane Pattern, 18.5cm. 7.4"	\$39.00/ea
	JOR49ME	Boston Terrier Pattern, 12cm. 4.8"	\$39.00/ea

Ear Clamp **JorVet BUY NOW**

Vendor	Item#	Details	Price
JORGENSEN	JOR49HC	Curved, 14 cm.	\$80.00/ea
	JOR49HB	Straight, 10 cm.	\$82.00/ea
	JOR49HD	Straight, 14 cm.	\$46.00/ea



Hernia Clamp **BUY NOW**

Vendor	Item#	Details	Price
JORGENSEN	JOR56G	Aluminum. 14cm.	\$46.50/ea



Huston Umbilical Clamp **BUY NOW**

Vendor	Item#	Details	Price
JORGENSEN	JOR56HA	Huston Hernia Clamp. 5"	\$9.00/ea
	JOR56HB	Huston Hernia Clamp. 7"	\$10.50/ea



Jones Towel Clamp **BUY NOW**

Vendor	Item#	Details	Price
ECONOMY	5-815	3.5"	\$2.95/ea
MID GRADE	5-815-S	3.5",Satin Finish	\$5.95/ea
GERMAN	11-110	4.5"	\$14.00/ea



Instrument Clamp Covers

JorVet

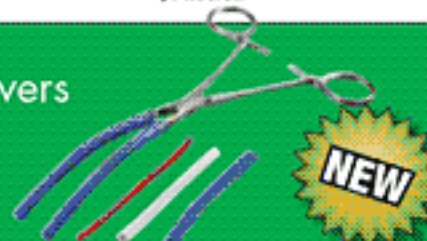

Vendor	Item#	Details	Price
JORGENSEN	JOR928	Packaged 12 per bag, four each of three sizes and colors: 2.5mm x 50mm (1/10" x 2"), 5mm x 50mm (2/10" x 2"), 7.5mm x 50mm (3/10" x 2").	\$22.50/dz

BUY NOW

Ligament Meniscus Clamp **BUY NOW**

Vendor	Item#	Price
JORGENSEN	JOR236C	\$170.00/ea



Lorna Towel Clamp **BUY NOW**

Vendor	Item#	Details	Price
ECONOMY	5-820	3.5"	\$4.95/ea
	5-821	5.5"	\$4.95/ea
MID GRADE	5-820-S	3.5",Satin Finish	\$7.95/ea
	5-821-S	5.5",Satin Finish	\$7.95/ea
GERMAN	11-104	4"	\$24.00/ea
	11-105	5.25"	\$24.00/ea
INTEGRA/MILTEX	MIL7-515	5.25"	\$122.48/ea

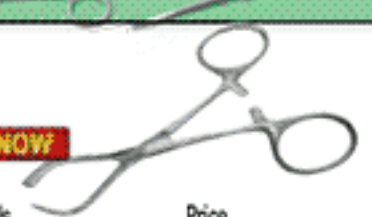

Martin Cartilage Clamp

Vendor	Item#	Details	Price
GERMAN	33-111	7"	\$60.00/ea



Micro Tooth Meniscus Clamp **BUY NOW**

Management of meniscal injuries is very important. In medium and small dogs space limits access. The toothed minimeniscus forceps are designed to grasp damaged meniscus tissue to facilitate removal using micro blades.

Vendor	Item#	Details	Price
JORGENSEN	JOR236H	The toothed minimeniscus forceps are designed to grasp damaged meniscus tissue to facilitate removal using micro blades.	\$36.00/ea



Vasectomy Ring Clamp (No Scalpel) **BUY NOW**

Vendor	Item#	Details	Price
INTEGRA/MILTEX	MIL29-805	5 1/2" (14cm), gold finger rings	\$203.54/ea



DeBaKey Vascular Clamp **BUY NOW**

Vendor	Item#	Details	Price
JORGENSEN	JOR72DV	Slightly Curved 7.5cm L jaw, Stainless steel., 23cm	\$270.00/ea



X-Small Serrated Bone Clamp **BUY NOW**

Vendor	Item#	Details	Price
JORGENSEN	JOR854	5" L	\$80.00/ea

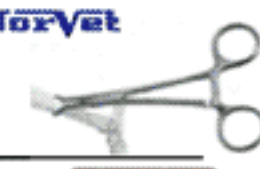

Instruments

Scissors

Aesculap Mayo Scissors

BUY NOW



Vendor	Item#	Details	Price
JORGENSEN	JOR663C	Tungsten Carbide Inserts, Gold-plated Rings, Curved 6 3/4"	\$193.00/ea
	JOR663	Tungsten Carbide Inserts, Gold-plated Rings, Straight, 6 3/4"	\$184.00/ea

Aesculap Metzenbaum Scissors

JorVet BUY NOW



Vendor	Item#	Details	Price
JORGENSEN	JOR662C	Tungsten Carbide Inserts, Gold-plated Rings, Curved 5 1/2"	\$185.00/ea
	JOR662DC	Tungsten Carbide Inserts, Gold-plated Rings, Curved 7"	\$205.00/ea
	JOR662D	Tungsten Carbide Inserts, Gold-plated Rings, Straight 7"	\$190.00/ea
	JOR662	Tungsten Carbide Inserts, Gold-plated Rings, Straight 5 1/2"	\$190.00/ea

Angle Serrated Wire Cutting Scissors

BUY NOW



Vendor	Item#	Details	Price
ECONOMY	4-380	5"	\$2.95/ea
MID GRADE	4-380-S	5",Satin Finish	\$5.95/ea

Bandage Scissors

BUY NOW



Vendor	Item#	Details	Price
INTEGRA/MILTEX	MIL5-700	5-1/2" (14 cm), Pink	\$46.89/ea

Castroviejo Scissors

BUY NOW



Vendor	Item#	Details	Price
GERMAN	01-158	4"	\$90.00/ea

Ear Cropping Scissors

BUY NOW



Vendor	Item#	Details	Price
GERMAN	01-164	6.25"	\$38.00/ea
	01-165	6.5" Sharp/Blunt	\$38.00/ea
	01-166	6.5" Blunt/Blunt	\$38.00/ea



Earcrop Cartilage Scissors

Vendor	Item#	Details	Price
JORGENSEN	JOR49S	one serrated edge. Stainless steel. 6 1/2"	\$30.00/ea

BUY NOW

Martin Cartilage Scissors

Vendor	Item#	Details	Price
JORGENSEN	JOR49X	8" 4 1/4" (10.8cm)	\$67.50/ea
GERMAN	33-110	8" Straight	\$45.00/ea
	33-112	8" Curved	\$50.50/ea
INTEGRA/MILTEX	MIL27-1000	8" Straight	\$183.56/ea

BUY NOW

German Surgical Scissors

JorVet

Vendor	Item#	Details	Price
JORGENSEN	JOR75BW	Curved, Blunt/Blunt 5 1/2"	\$22.00/ea
	JOR75AW	Curved, Sharp/Blunt, 5 1/2"	\$22.00/ea
	JOR75FW	Curved, Sharp/Sharp, 5 1/2"	\$22.00/ea
	JOR75DW	Straight, Blunt/Blunt, 5 1/2"	\$22.00/ea
	JOR75EW	Straight, Sharp/Sharp, 5 1/2"	\$22.00/ea

German Bandage Scissors

BUY NOW

Vendor	Item#	Details	Price
JORGENSEN	JOR74WA	5 1/2"	\$28.50/ea
	JOR74WB	7 1/2"	\$32.30/ea

Iris Ribbon Scissors

Vendor	Item#	Details	Price
INTEGRA/MILTEX	MIL18-1418	3.75" Curved	\$123.29/ea

BUY NOW

Iris Scissors

BUY NOW

JorVet

Vendor	Item#	Details	Price
ECONOMY	4-330	4.5" Straight	\$2.95/ea
	4-331	4.5" Curved	\$2.95/ea
MID GRADE	4-330-S	4.5",Straight, Satin Finish	\$5.95/ea
	4-331-S	4.5",Curved, Satin Finish	\$5.95/ea
JORGENSEN	JOR75IWC	Curved, 4 1/2"	\$22.80/ea
	JOR75IWS	Straight, 4 1/2"	\$22.80/ea
GERMAN	01-144	3.5" Straight	\$15.00/ea
	01-145	3.5" Curved Delicate	\$15.00/ea
	01-148	4.5" Straight	\$15.00/ea
	01-149	4.5" Curved	\$15.00/ea
	01-150	4.5" Curved Tungsten Carbide	\$68.00/ea
	01-151	4.5" Straight Tungsten Carbide	\$68.00/ea
INTEGRA/MILTEX	MIL5-302	3.5" Curved	\$67.71/ea
	MIL5-304	4.5" Straight	\$63.38/ea
	MIL5-304-TC	4 1/2" (11.4 cm), Straight, Tungsten Carbide	\$165.39/ea
	MIL5-306	4.5" Curved	\$66.30/ea

Instruments

Scissors

Knowles Bandage Scissors

Vendor	Item#	Details	Price
ECONOMY	2-150	5.5"	\$3.95/ea
JORGENSEN	JOR74X	(5 1/2")	\$25.50/ea
MID GRADE	2-150-S	5.5", Satin Finish	\$6.95/ea
GERMAN	02-106	5.5"	\$22.00/ea
INTEGRA/MILTEX	MIL5-560	5.5"	\$74.62/ea

Lister Bandage Scissors

Vendor	Item#	Details	Price
ECONOMY	2-120	3.5"	\$2.95/ea
	2-125	4.5"	\$2.95/ea
	2-130	5.5"	\$2.95/ea
	2-145	7.5"	\$3.95/ea
JORGENSEN	JOR74A	5 1/2"	\$4.05/ea
	JOR74B	7 1/2"	\$15.83/ea
MID GRADE	2-120-S	3.5", Satin Finish	\$5.95/ea
	2-125-S	4.5", Satin Finish	\$5.95/ea
	2-130-S	5.5", Satin Finish	\$5.95/ea
	2-145-S	7.5", Satin Finish	\$6.95/ea
GERMAN	02-100	3.5"	\$18.00/ea
	02-101	4.5"	\$18.00/ea
	02-102	5.5"	\$18.00/ea
	02-103	7.5"	\$18.00/ea
INTEGRA/MILTEX	MIL5-510	3.5"	\$50.63/ea
	MIL5-512	4.5"	\$52.58/ea
	MIL5-516	7.25"	\$90.00/ea
	MIL5-550	8"	\$147.44/ea

Littauer Stitch Scissors

Vendor	Item#	Details	Price
ECONOMY	4-370	4.5"	\$2.95/ea
	4-371	5.5"	\$2.95/ea
MID GRADE	4-370-S	4.5", Straight Satin Finish	\$5.95/ea
JORGENSEN	JOR76	Economy, 5 1/2"	\$4.80/ea
GERMAN	02-113	4.5"	\$18.00/ea
	02-114	5.5"	\$18.00/ea
INTEGRA/MILTEX	MIL9-102	4.5"	\$82.49/ea

Mayo Dissecting Scissors

Vendor	Item#	Details	Price
GERMAN	01-308	6.75" Tungsten Carbide Straight	\$86.00/ea
	01-309	6.75" Tungsten Carbide Curved	\$86.00/ea
INTEGRA/MILTEX	MIL5-120	5.5" Straight	\$62.67/ea
	MIL5-124	6.75" Straight	\$73.38/ea
	MIL5-126	6.75" Curved	\$78.63/ea

Mayo Scissors

Vendor	Item#	Details	Price
ECONOMY	4-300	5.5" Straight	\$2.95/ea
	4-301	5.5" Curved	\$2.95/ea
	4-302	6.75" Straight	\$3.95/ea
	4-303	6.75" Curved	\$3.95/ea
MID GRADE	4-301-S	5.5", Curved, Satin Finish	\$5.95/ea
	4-300-S	5.5", Straight Satin Finish	\$5.95/ea
	4-303-S	6.75", Curved, Satin Finish	\$6.95/ea
	4-302-S	6.75", Straight, Satin Finish	\$6.95/ea
GERMAN	01-122	5.5" Straight Rounded Blades	\$19.00/ea
	01-123	5.5" Curved	\$19.00/ea
	01-124	6.75" Straight, Rounded Blades	\$19.00/ea
	01-125	6.75" Curved Rounded Blades	\$19.00/ea
JORGENSEN	JOR77CWA	Curved, 5 1/2"	\$24.70/ea
	JOR77CWB	Curved, 6 3/4"	\$25.80/ea
	JOR77SWA	Straight, 5"	\$22.80/ea
	JOR77SWB	Straight, 7"	\$24.70/ea
	JOR77AC	Economy, Curved, 7"	\$7.80/ea
	JOR77BC	Economy, Serrated, Curved	\$8.00/ea
	JOR77BS	Economy, Serrated, Straight	\$7.80/ea
	JOR77AS	Economy, Straight, 7"	\$7.00/ea

Metzenbaum Scissors

Vendor	Item#	Details	Price
ECONOMY	4-320	5.75" Straight	\$3.95/ea
	4-321	5.75" Curved	\$3.95/ea
	4-322	7" Straight	\$3.95/ea
	4-323	7" Curved	\$3.95/ea
MID GRADE	4-320-S	5.75", Straight, Satin Finish	\$6.95/ea
	4-321-S	5.75", Curved, Satin Finish	\$6.95/ea
	4-322-S	7", Straight Satin Finish	\$6.95/ea
	4-323-S	7", Curved Satin Finish	\$6.95/ea
GERMAN	01-128	5.5" Straight	\$21.00/ea
	01-129	5.5" Curved	\$21.00/ea
	01-130	7" Straight	\$21.00/ea
	01-131	7" Curved	\$21.00/ea
	01-155	5.75" Curved Tungsten Carbide	\$78.00/ea
	01-320	9" Curved Tungsten Carbide	\$99.00/ea
INTEGRA/MILTEX	MIL5-179	5.5" Straight	\$79.53/ea
	MIL5-180	5.5" Curved	\$82.94/ea
	MIL5-181	7" Straight	\$89.87/ea
	MIL5-182	7" Curved	\$91.88/ea
	MIL5-186	9" Straight	\$160.38/ea
	MIL5-190	11" (27.9 cm), (NELSON), straight Standard Pattern	\$231.08/ea
	MIL5-284	5" Curved Delicate	\$95.83/ea

Scissors

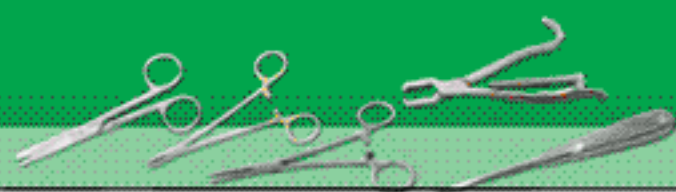

Mayo-Stille Scissors

BUY NOW



Vendor	Item#	Details	Price
GERMAN	12-167	5.5" Curved	\$32.00/ea
	12-168	5.5" Straight	\$32.00/ea
	12-169	6.75" Curved	\$32.00/ea
	12-170	6.75" Straight	\$32.00/ea

Northbent Stitch Scissors

Vendor	Item#	Details	Price
GERMAN	02-116	4.5"	\$18.00/ea

BUY NOW



Operating Scissors



BUY NOW

Vendor	Item#	Details	Price
ECONOMY	4-180	4.5" Sharp/Blunt Straight	\$2.95/ea
	4-200	4.5" Sharp/Sharp Curved	\$2.95/ea
	4-201	4.5" Blunt/Blunt Straight	\$2.95/ea
	4-202	4.5" Sharp/Blunt Curved	\$2.95/ea
	4-204	4.5" Blunt/Blunt Curved	\$2.95/ea
	4-221	4.5" Sharp/Sharp Straight	\$2.95/ea
	4-220	5.5" Sharp/Blunt Straight	\$2.95/ea
	4-222	5.5" Sharp/Sharp Straight	\$2.95/ea
	4-223	5.5" Sharp/Blunt Curved	\$2.95/ea
	4-224	5.5" Sharp/Sharp Curved	\$2.95/ea
	4-226	5.5" Blunt/Blunt Straight	\$2.95/ea
	4-228	6.5" Blunt/Blunt Straight	\$2.95/ea
	4-230	5.5" Blunt/Blunt Curved	\$2.95/ea
	4-232	6.5" Blunt/Blunt Curved	\$2.95/ea
	4-240	6.5" Sharp/Blunt Straight	\$3.95/ea
	4-241	6.5" Sharp/Sharp Straight	\$3.95/ea
	4-244	6.5" Sharp/Blunt Curved	\$3.95/ea

Vendor	Item#	Details	Price
MID GRADE	4-180-S	4 1/2", Sharp/Blunt Straight Satin Finish	\$5.95/ea
	4-200-S	4.5", Sharp/Sharp, Curved, Satin Finish	\$5.95/ea
	4-201-S	4.5", Blunt/Blunt, Straight, Satin Finish	\$5.95/ea
	4-202-S	4 1/2", Sharp/Blunt, Curved, Satin Finish	\$5.95/ea
	4-204-S	4 1/2", Blunt/Blunt, Curved, Satin Finish	\$5.95/ea
	4-221-S	4 1/2", Sharp/Sharp, Straight, Satin Finish	\$5.95/ea
	4-220-S	5.5", Sharp/Blunt, Straight Satin Finish	\$5.95/ea
	4-222-S	5.5", Sharp/Sharp, Straight, Satin Finish	\$5.95/ea
	4-223-S	5.5", Sharp/Blunt, Curved, Satin Finish	\$5.95/ea
	4-224-S	5.5", Sharp/Sharp, Curved, Satin Finish	\$5.95/ea
	4-226-S	5 1/2", Blunt/Blunt, Straight, Satin Finish	\$5.95/ea
	4-228-S	6 1/2", Blunt/Blunt, Straight, Satin Finish	\$5.95/ea
	4-230-S	5 1/2", Blunt/Blunt, Curved, Satin Finish	\$5.95/ea
	4-232-S	6 1/2", Blunt/Blunt, Curved, Satin Finish	\$5.95/ea
	4-240-S	6.5", Sharp/Blunt, Straight, Satin Finish	\$6.95/ea
	4-241-S	6.5", Sharp/Sharp, Straight, Satin Finish	\$6.95/ea
	4-244-S	6.5", Sharp/Blunt, Curved, Satin Finish	\$6.95/ea

Vendor	Item#	Details	Price
GERMAN	01-100	4.5" Sharp/Blunt Straight	\$19.00/ea
	01-101	4.5" Blunt/Blunt Straight	\$19.00/ea
	01-102	4.5" Sharp/Sharp Straight	\$19.00/ea
	01-103	4.5" Sharp/Blunt Curved	\$19.00/ea
	01-104	4.5" Blunt/Blunt Curved	\$19.00/ea
	01-105	4.5" Sharp/Sharp Curved	\$19.00/ea
	01-108	5.5" Sharp/Blunt Straight	\$19.00/ea
	01-109	5.5" Blunt/Blunt Straight	\$19.00/ea
	01-110	5.5" Sharp/Sharp Straight	\$19.00/ea
	01-111	5.5" Sharp/Blunt Curved	\$19.00/ea
	01-112	5.5" Blunt/Blunt Curved	\$19.00/ea
	01-113	5.5" Sharp/Sharp Curved	\$19.00/ea
	01-114	6.5" Sharp/Blunt Straight	\$19.00/ea
	01-115	6.5" Blunt/Blunt, Straight	\$19.00/ea
	01-116	6.5" Sharp/Sharp Straight	\$19.00/ea
	01-117	6.5" Sharp/Blunt Curved	\$19.00/ea
	01-118	6.5" Blunt/Blunt Curved	\$19.00/ea
	01-119	6.5" Sharp/Sharp Curved	\$19.00/ea

Vendor	Item#	Details	Price
INTEGRA/MILTEX	MIL5-12	4.5" Sharp/Blunt Straight	\$51.89/ea
	MIL5-14	5" Sharp/Blunt Straight	\$52.45/ea
	MIL5-16	5.5" Sharp/Blunt Straight	\$53.40/ea
	MIL5-18	6.5" Sharp/Blunt Straight	\$61.43/ea
	MIL5-2	4.5" Sharp/Sharp Straight	\$51.89/ea
	MIL5-22	4.5" Blunt/Blunt Straight	\$51.89/ea
	MIL5-24	5" Blunt/Blunt Straight	\$52.45/ea
	MIL5-26	5.5" Blunt/Blunt Straight	\$53.40/ea
	MIL5-36	5.5" Sharp/Sharp Curved	\$60.34/ea
	MIL5-38	6.5" Sharp/Sharp Curved	\$69.90/ea
	MIL5-4	5" Sharp/Sharp Straight	\$52.45/ea
	MIL5-42	4.5" Sharp/Blunt Curved	\$58.04/ea
	MIL5-46	5.5" Sharp/Blunt Curved	\$61.89/ea
	MIL5-48	6.5" Sharp/Blunt Curved	\$68.24/ea
	MIL5-52	4.5" Blunt/Blunt Curved	\$56.59/ea
	MIL5-56	5.5" Blunt/Blunt Curved	\$60.34/ea
	MIL5-58	6.5" Blunt/Blunt Curved	\$70.31/ea
	MIL5-6	5.5" Sharp/Sharp Straight	\$53.40/ea
	MIL5-8	6.5" Sharp/Sharp Straight	\$62.67/ea

Scissors

Jorvet Post Mortem Scissors

Heavy-duty scissors with one serrated edge and black finished rings. **Jorvet**

Vendor	Item#	Details	Price
JORGENSEN	JOR75N	2" cutting blade, 7 3/4"L	\$25.50/ea

Serrated Spay Scissors

Serrated, Curved Spay Scissors. 12".

Vendor	Item#	Details	Price
JORGENSEN	JOR87	12"	\$40.00/ea
	JOR87L	16"	\$42.00/ea

Ribbon Iris Scissors

Vendor	Item#	Details	Price
GERMAN	14-110	4.25" Curved	\$59.00/ea
BUY NOW	14-111	4.25" Straight	\$59.00/ea

Spencer Stitch Scissors

Vendor	Item#	Details	Price
ECONOMY	4-360	3.5"	\$2.95/ea
MID GRADE	4-360-S	3.5", Satin Finish	\$5.95/ea
JORGENSEN	JOR76SW	German, 3 1/2" x 3 1/2"	\$28.00/ea
	JOR76W	German, 5 1/2"	\$28.00/ea
GERMAN	02-112	3.5" Straight	\$17.00/ea
INTEGRA/MILTEX	MIL9-100	3"	\$71.39/ea

Stevens Tenotomy Scissors

Vendor	Item#	Details	Price
JORGENSEN	JOR75TB	Straight, Blunt, 4 1/4" (10.8cm) x 4 1/4" (10.8cm)	\$26.25/ea
	JOR75TS	Straight, Pointed, 4 1/4" (10.8cm) x 4 1/4" (10.8cm)	\$26.25/ea
GERMAN	01-250	4.25" Straight Sharp	\$28.00/ea
	01-251	4.25" Curved Sharp	\$28.00/ea
INTEGRA/MILTEX	MIL18-1470	4.25" Straight	\$102.62/ea
	MIL18-1474	4.25" Curved	\$109.97/ea
	MIL18-1476	4-1/2" (11.4 cm), curved, long blades, blunt point	\$109.97/ea
	MIL18-1466	4-1/8" (10.5 cm), curved, short blades, blunt points	\$109.97/ea

Stitch Scissors

Vendor	Item#	Details	Price
JORGENSEN	JOR76SW	German, 3 1/2"	\$28.00/ea
	JOR76W	German, 5 1/2"	\$28.00/ea

Strabismus Scissors

Vendor	Item#	Details	Price
GERMAN	01-142	4.5" Straight	\$48.00/ea
	01-143	4.5" Curved	\$48.00/ea

BUY NOW

Super Cut Mayo Scissors

Vendor	Item#	Details	Price
JORGENSEN	JOR910SC	Curved, 5 1/2" (14cm)	\$106.00/ea
	JOR910C	Curved, 6 3/4" (17cm)	\$106.00/ea
	JOR910SA	Straight, 5 1/2" (14cm)	\$105.00/ea
	JOR910S	Straight, 6 3/4" (17cm)	\$105.00/ea

Super Cut Metzenbaum Scissors

Vendor	Item#	Details	Price
JORGENSEN	JOR911CA	Curved, 5 3/4" (14cm)	\$105.00/ea
	JOR911C	Curved, 7" (18cm)	\$103.50/ea
	JOR911S	Straight, 7" (18cm)	\$123.00/ea

Supercut Gradle Scissors

Vendor	Item#	Details	Price
INTEGRA/MILTEX	MIL18-SC-1652	3-3/4" CURVED	\$204.32/ea

Supercut Mayo Scissors

Vendor	Item#	Details	Price
INTEGRA/MILTEX	MIL5-SC-122	5-1/2" (14 cm), curved	\$174.70/ea

Jorvet Surgical Scissors

Vendor	Item#	Details	Price
JORGENSEN	JOR75CW	German, Straight, Sharp/Blunt, 5 1/2"	\$22.00/ea

Vise Grip Style Pin Removal Forceps

Vendor	Item#	Details	Price
JORGENSEN	JOR4420	Stainless steel 7" (175mm)	\$99.00/ea

Instruments

Scissors & Nail Nippers

Utility Bandage Scissors

BUY NOW



Vendor	Item#	Details	Price
ECONOMY	3-169	5.5"	\$3.95/ea
	3-170	7.5"	\$3.95/ea
GERMAN	02-109	7.5"	\$7.00/ea
INTEGRA/MILTEX	MIL5-1000	7.5"	\$22.06/ea
	MIL5-998	6.5"	\$22.06/ea

Universal Lister Scissors

BUY NOW



Universal Lister Bandage Scissors. Black. 5 1/2".
Smaller than JOR75u.

Vendor	Item#	Details	Price
JORGENSEN	JOR75U	7 1/2"	\$9.40/ea
	JOR75US	Black, 5 1/2" Smaller than JOR75u.	\$9.00/ea

Anvil Nail Splitting Forceps

BUY NOW

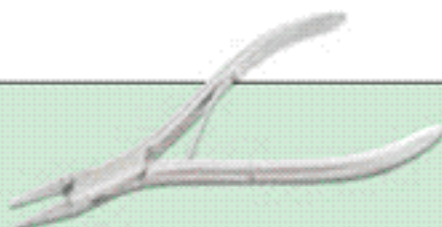

Vendor	Item#	Details	Price
GERMAN	35-120	5"	\$36.00/ea
INTEGRA/MILTEX	MIL40-230	5"	\$193.10/ea

Barrel Spring Nail Nipper

BUY NOW

INTEGRA Miltex



Vendor	Item#	Details	Price
GERMAN	35-125	4.5", Concave	\$59.00/ea
	35-127	concave, 5.5"	\$39.00/ea
INTEGRA/MILTEX	MIL40-205	4.5" Concave Jaws, Barrel spring	\$48.93/ea
	MIL40-207	5.5" Concave Jaws, Barrel spring	\$60.67/ea

Double Action Nail Nipper

BUY NOW



Vendor	Item#	Details	Price
GERMAN	35-129	concave, 5 1/2", barrel spring,	\$72.00/ea

Westcott Tenotomy Scissors

BUY NOW

NEW



Vendor	Item#	Details	Price
INTEGRA/MILTEX	MIL18-1487	5-1/4" (13.3 cm), right, wide handles	\$421.51/ea

White's Toenail Scissors

BUY NOW



Vendor	Item#	Details	Price
JORGENSEN	JOR84	4"	\$6.90/ea
	JOR84G	German-made, 4"	\$33.00/ea
GERMAN	01-228	4.5"	\$35.00/ea

Wire Cutting Scissors

BUY NOW



Vendor	Item#	Details	Price
MID GRADE	4-380-S	5", Satin Finish	\$5.95/ea
GERMAN	14-120	4 3/4", Angle Serrated	\$19.00/ea
	14-121	4.25" Curved	\$20.00/ea
	14-123	4.25" Straight	\$18.00/ea

Double Spring Nail Nipper

BUY NOW



Vendor	Item#	Details	Price
GERMAN	35-132	straight, 6"	\$36.00/ea
	35-134	concave, 5 1/2"	\$36.00/ea
	35-138	angled concave, 5 1/2"	\$36.00/ea
	35-136	concave, 6 1/2"	\$36.00/ea
INTEGRA/MILTEX	MIL40-210SS	5.5" Concave	\$161.37/ea

Hoof Crease Nail Puller

BUY NOW



Vendor	Item#	Details	Price
JORGENSEN	JOR1024	12" (30cm) Stainless	\$39.00/ea

Hoof nipper or trimmer

Vendor	Item#	Price
JORGENSEN	JOR1024B	\$51.00/ea



BUY NOW

Nail Nippers

Nail Splitter

INTEGRA *Miltek*

BUY NOW



Vendor	Item#	Details	Price
MILTEX	MIL40-226A	Straight Jaws, Extra Narrow, Double Spring	\$210.18/ea
MILTEX	MIL40-226-SS	5" Straight, Double Spring	\$208.36/ea

Equine Shoe Puller/Spreader

Jorvet

To remove the shoes or also to adjust a shoe by spreading it for a better fit. **BUY NOW**



Vendor	Item#	Details	Price
JORGENSEN	JOR1024A	12" (30cm) Stainless	\$42.00/ea

Tissue/Cuticle Nipper

INTEGRA *Miltek*

BUY NOW



Vendor	Item#	Details	Price
GERMAN	35-117	4.5" Convex Jaws	\$36.00/ea
MILTEX	MIL40-250SS	4.5"	\$97.47/ea

Bone Plate Holding Forceps

BUY NOW

Vendor	Item#	Details	Price
JORGENSEN	JOR212P	6" (15 cm).	\$133.00/ea

Bone Holding Forceps

BUY NOW

Vendor	Item#	Details	Price
GERMAN	33-150	7" with Ratchet	\$58.00/ea
JORGENSEN	JOR159M	10cm, 4" Medium, 135mm.	\$105.00/ea
JORGENSEN	JOR213	Stainless steel, 15 cm, 6".	\$133.00/ea

Bone Fragment Forceps

BUY NOW

Vendor	Item#	Details	Price
GERMAN	13-114	curved with ratchet, 5.5"	\$34.00/ea
JORGENSEN	JOR212	6" Stainless Steel	\$133.00/ea
JORGENSEN	JOR212M	Medium, 135mm.	\$119.00/ea/ea

Kern Holding Forceps

BUY NOW

Vendor	Item#	Details	Price
GERMAN	33-142	6.75" Petite Size with Ratchet	\$98.00/ea
GERMAN	33-146	9" Standard Size with Ratchet	\$120.00/ea
INTEGRA/MILTEX	MIL27-2	8.5"	\$474.50/ea

Baby Kerns Bone Forceps

INTEGRA *Miltek*

Vendor	Item#	Details	Price
JORGENSEN	JOR159	15cm, 6"	\$147.00/ea
JORGENSEN	JOR159L	Standard, 8" (21cm)	\$169.00/ea

Mini Baby Kerns Bone Holding Forceps

Vendor	Item#	Details	Price
JORGENSEN	JOR159M	10cm, 4"	\$105.00/ea

Liston Bone Cutting Forceps

Vendor	Item#	Details	Price
GERMAN	33-157	7.5" Straight	\$76.00/ea
GERMAN	33-157A	7.5" Angled on Flat	\$76.00/ea
GERMAN	33-162	10.5" Straight	\$150.00/ea
JORGENSEN	JOR223	German, Stainless Steel, 5 1/2".	\$175.00/ea

Ruskin-Liston Bone Cutting Forceps

Vendor	Item#	Details	Price
GERMAN	V-375	7.5" Double Action Straight	\$99.00/ea
GERMAN	V-375B	7.5" Double Action, Angled Standard Blades	\$170.00/ea
JORGENSEN	JOR223A	5.5" Double Action Straight	\$210.00/ea
JORGENSEN	JOR223B	7.5" Double Action Straight	\$220.00/ea

Twin Point Fragment Forceps

Vendor	Item#	Details	Price
JORGENSEN	JOR212TS	Straight Tip, 6 1/2"	\$123.00/ea
Jorvet	JOR212TC	Curved Tip, 6 1/2"	\$133.00/ea

Jorvet Small Fragment Forceps

Single pointed reduction forceps typically applies pressure at the exact point where it is desirable to place an implant. **BUY NOW**

Vendor	Item#	Details	Price
JORGENSEN	JOR212S	5 1/4"	\$122.00/ea
JORGENSEN	JOR212L	Extra Large, 8". May be used to provide temporary stabilization of osteotomy while the plate is contoured and placed.	\$128.00/ea
JORGENSEN	JOR212LS	Large, Spin Lock Closure, 7 1/2"	\$163.00/ea
JORGENSEN	JOR212M	Medium, 135mm.	\$119.00/ea

Jorvet Small Angles Bone Cutter

Especially useful for small dogs and cats. The jaws have the ideal size and angle for:

- Femoral head and neck excision
- Tibial crest translocation
- Many other small bone cutting procedures

Vendor	Item#	Details	Price
JORGENSEN	JOR223S	15mm blade, 6 1/2" (170mm) length.	\$125.00/ea

Instruments



Rongeurs

Beyer Rongeur

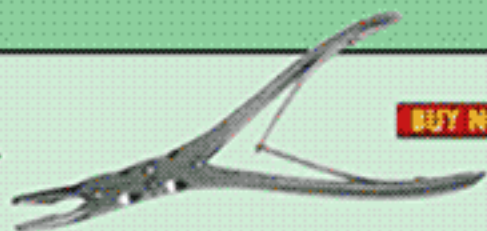

BUY NOW

Vendor	Item#	Details	Price
GERMAN	33-163	7", Curved, Double Action 3mm Jaw	\$150.00/ea

Bone Rongeur



BUY NOW

Vendor	Item#	Details	Price
GERMAN	33-162A	Straight Jaws (10x25mm), 10.5"	\$150.00/ea

Duck-Billed Mini Rongeur



BUY NOW

Vendor	Item#	Details	Price
JORGENSEN	JOR224	2mm bite, 5 1/4" 51/4"	\$134.00/ea
GERMAN	V-415	5.25"	\$82.00/ea

Jorvet Ecklin-Duckbill Rongeur

BUY NOW

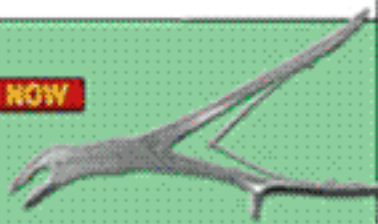

Vendor	Item#	Details	Price
JORGENSEN	JOR225E	8 1/2"	\$196.00/ea/ea

Equine Dental Compound Rongeur

BUY NOW



Vendor	Item#	Details	Price
JORGENSEN	JOR225X	9" length	\$110.00/ea

Laminectomy Rongeurs

Jorvet BUY NOW

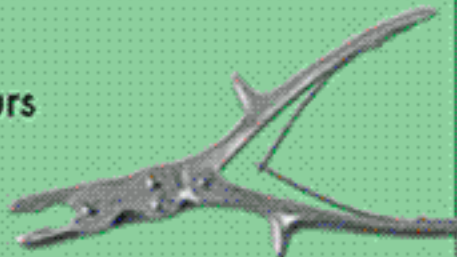

Vendor	Item#	Details	Price
JORGENSEN	JOR225LRA	2mm x 16cm 2mm x 16cm	\$135.00/ea
	JOR225LRB	3mm x 16cm 3mm x 16cm	\$135.00/ea
	JOR225LRC	4mm x 16cm 4mm x 16cm	\$135.00/ea

Leksell Rongeur

TOP SELLER



BUY NOW

Vendor	Item#	Details	Price
GERMAN	33-164	8" Standard Curve, 3mm Bite Jaws	\$150.00/ea

Lempert Rongeur

BUY NOW



Vendor	Item#	Details	Price
GERMAN	33-160	7", 8mm bite, Curved	\$98.00/ea
	33-256	6.25" 2.5mm bite, Straight	\$110.00/ea

Micro Friedman Rongeur

BUY NOW



Vendor	Item#	Details	Price
GERMAN	36-102	5 1/2", 1.3mm Jaws, Curved	\$99.00/ea
	36-103	5 1/2", 1.3mm Jaws, Straight	\$99.00/ea
JORGENSEN	JOR224F	Very delicate, 5 1/2" (14cm) Curved Jaw, 1.3mm W	\$102.00/ea

Oral Surgery Rongeur

BUY NOW



Vendor	Item#	Details	Price
INTEGRA/MILTEX	MIL22-486	5 1/2" (14 cm), no. 4 pattern, slightly curved beaks	\$379.61/ea

Ruskin Rongeur

BUY NOW

Jorvet

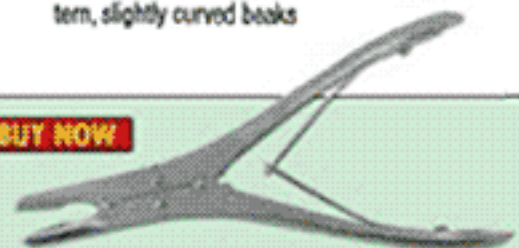

Vendor	Item#	Details	Price
JORGENSEN	JOR225C	Curved, 4mm bite, 18cm (7")	\$190.00/ea
	JOR225S	Straight, 4mm bite, 18cm (7")	\$190.00/ea

Jorvet Stille-Luer Rongeur

Jorvet BUY NOW



Vendor	Item#	Details	Price
JORGENSEN	JOR225L	Curved, 8mm bite, 22cm (8 1/2")	\$190.00/ea

Elevators & Chisels



Chandler Elevator

BUY NOW



Vendor	Item#	Details	Price
GERMAN	46-250	1/2" Taper	\$25.20/ea
	46-252	3/4" Taper	\$28.32/ea

Lane Elevator

BUY NOW



Vendor	Item#	Details	Price
GERMAN	33-261	Broad	\$39.00/ea

Freer Elevator

BUY NOW



Vendor	Item#	Details	Price
JORGENSEN	JOR2260	Stainless Steel, 7" (18cm).	\$49.00/ea

Key Periosteal Elevator



Vendor	Item#	Details	Price
GERMAN	V-420A	7", 6mm wide	\$36.00/ea
	V-420B	7", 12mm wide	\$36.00/ea
	V-420C	7", 19mm wide	\$36.00/ea
JORGENSEN	JOR226A	German, Stainless Steel, 190mm. (7 1/2"), Blade, 12mm	\$64.00/ea
JORGENSEN	JOR226B	German, Stainless Steel, 190mm. (7 1/2"), Blade, 19mm	\$64.00/ea
JORGENSEN	JOR226C	Blade, 19mm	\$64.00/ea

Periosteal Elevator



Vendor	Item#	Details	Price
GERMAN	33-272	14mm	\$50.00/ea
JORGENSEN	JOR226S	180mm. (7 1/2"), Curved 6mm tip	\$68.00/ea
JORGENSEN	JOR226R	180mm. (7 1/2"), Square 6mm tip	\$63.50/ea

Chisel

BUY NOW



Vendor	Item#	Details	Price
GERMAN	13-174	5/16" x 5.5" straight	\$39.00/ea
	13-175	3/8" x 5.5" straight	\$39.00/ea
	13-177	1/2" x 5.5" straight	\$39.00/ea

Jorvet Bone Chisel

BUY NOW



Vendor	Item#	Details	Price
JORGENSEN	JOR227A	Stainless Steel, 6mm, 17cm L (6 1/2")	\$54.00/ea
JORGENSEN	JOR227B	Stainless Steel, 12mm, 17cm L (6 1/2")	\$54.00/ea

Jorgensen Osteotome

BUY NOW



Vendor	Item#	Details	Price
GERMAN	V-430	5" 10mm wide	\$28.00/ea
JORGENSEN	JOR228A	Stainless Steel, 13.5cm (5"), Blade 10mm W	\$42.00/ea
JORGENSEN	JOR228B	Stainless Steel, 13.5cm (5"), Blade 16mm W	\$42.00/ea

U.S Army Pattern Chisel

BUY NOW



Vendor	Item#	Details	Price
German	V-425A	6mm	\$36.00/ea
	V-425B	12mm	\$36.00/ea

Key Periosteal Elevator

BUY NOW



Vendor	Item#	Details	Price
JORGENSEN	JOR226C	German, Stainless Steel, 190mm. (7 1/2"), Blade, 19mm	\$64.00/ea
JORGENSEN	JOR226A	German, Stainless Steel, 190mm. (7 1/2"), Blade, 6mm	\$64.00/ea
JORGENSEN	JOR226B	German, Stainless Steel, 190mm. (7 1/2"), Blade, 12mm	\$64.00/ea

Periosteal Elevator



A popular configuration available in 6mm curved tip. Lightweight fiber handle.

Vendor	Item#	Details	Price
JORGENSEN	JOR226S	180mm. (7 1/2"), Curved 6mm tip	\$68.00/ea
JORGENSEN	JOR226R	180mm. (7 1/2"), Square 6mm tip	\$63.50/ea

Lambotte Osteotome

BUY NOW



Vendor	Item#	Details	Price	
GERMAN	33-224	4mm, 5"	\$32.00/ea	
	33-227	10mm x 5" straight	\$32.00/ea	
	33-229	14mm, 5"	\$32.00/ea	
	33-231	21mm, 8" Straight	\$32.00/ea	
	33-232	4mm, 7"	\$32.00/ea	
	33-234	6mm, 8" Straight	\$32.00/ea	
	33-235	10mm, 8" Straight	\$32.00/ea	
	33-236	13mm, 8" Straight	\$32.00/ea	
	33-238	19mm, 8" Straight	\$32.00/ea	
	33-248	25mm, 8", Straight	\$48.00/ea	
	INTEGRA/	MIL27-488	6mm, 9"	\$145.87/ea
	MILTEX	MIL27-490	13mm, 9"	\$148.07/ea

Instruments

Rasps & Curettes

Excision Rasp

BUY NOW



Vendor	Item#	Details	Price
JORGENSEN	JOR209	Excision Arthroplasty, Stainless steel, 17cm or 6.5" in length	\$66.00/ea

Putti Bone Rasp

BUY NOW

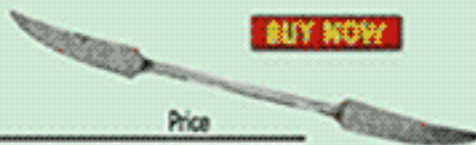

Vendor	Item#	Details	Price
GERMAN	33-362	10.5", double-ended, flat	\$130.00

Diamond Molar Rasps

BUY NOW



Vendor	Item#	Details	Price
JORGENSEN	JOR41R	Rasp, Molar For Rabbits	\$36.00/ea

Modular Osteotome

BUY NOW

A comfortable fiber composite handle with metal end to take hammering. Blade 1.1mm in thickness. This makes a great choice for procedures like block sulcoplasty. The blades can be changed intra-operatively for proper fit during the procedure. Supplied as a complete kit with 7 different blades, or purchase handle and blades separately.

Vendor	Item#	Details	Price
JORGENSEN	JOR1068	handle only and screw driver for changing blades	\$93.00/ea

Modular Osteotome Blades

BUY NOW

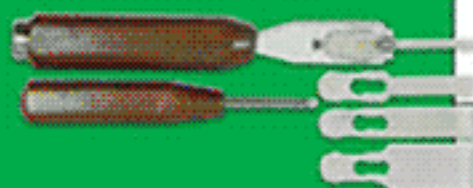

Vendor	Item#	Details	Price
JORGENSEN	JOR1068MD	10mm	\$42.00/ea
	JOR1068ME	12mm	\$42.00/ea
	JOR1068MF	15mm	\$42.00/ea
	JOR1068MG	20mm	\$42.00/ea
	JOR1068MA	4mm	\$42.00/ea
	JOR1068MB	6mm	\$42.00/ea
	JOR1068MC	8mm	\$42.00/ea
	JOR1068MK	Handle and set of all 7 blades, includes screw driver	\$295.00/ea

Super-Slim Block Resection Osteotome

J&Vet

Vendor	Item#	Price
JORGENSEN	JOR1068A	\$38.00/ea



Fomon Rasp



BUY NOW

Vendor	Item#	Details	Price
JORGENSEN	JOR209F	8 1/4" (21cm).	\$105.00/ea
GERMAN	21-276	8.25"	\$90.00/ea
INTEGRA/MILTEX	MIL21-369	8.25"	\$166.39/ea

Trochlear Rasp

BUY NOW

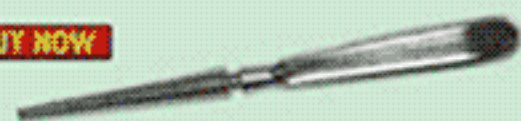

Vendor	Item#	Details	Price
JORGENSEN	JOR210	6.5"	\$99.00/ea

Putti Bone Rasp

BUY NOW



INTEGRA Miltex

Vendor	Item#	Details	Price
INTEGRA/MILTEX	MIL27-702	12" (30.5 cm), round and half-round tapered curved ends	\$313.87/ea

Saalfeld Comedone Extractor

INTEGRA Miltex



Vendor	Item#	Details	Price
INTEGRA/MILTEX	MIL33-204	5-3/4" (14.6 cm), with acne lancet	\$31.34/ea
	MIL33-206	4-1/4", (10.8 cm), with acne lancet	\$24.28/ea

BUY NOW

Modified Stifle Retractor

J&Vet

NEW

Designed for medium and large dogs (the group with the highest incidence of meniscal damage), this improved model has longer jaw tips which are self-protecting when the instrument is in the closed position. Once inserted atraumatically into the stifle, distraction exposes the longer tips for maximum grip. The best instrument to examine the caudal horn of the medial meniscus.

Vendor	Item#	Details	Price
JORGENSEN	JOR240WM	(15-50 Kg), 7 1/2"	\$213.00/ea

BUY NOW



NEW

Instruments



Curettes

Billeau Ear Curette

Vendor	Item#	Details	Price
JORGENSEN	JOR49P	German, 6"	\$24.00/ea

BUY NOW

Bone Curette **BUY NOW**

Vendor	Item#	Details	Price
GERMAN	13-127	#5, 6.75" Oval	\$28.00/ea
	13-140	Round Size 5, 12mm, 6.75"	\$48.00/ea
	13-141	Round 14mm, 6.75"	\$48.00/ea
	V-405B-R	Round 3mm	\$32.00/ea
	V-405C-O	Oval 5mm x 7mm	\$32.00/ea
	V-405C-R	Round 8mm	\$32.00/ea
JORGENSEN	JOR222	Oval 6mm x 8mm	\$37.50/ea
	JOR13123	Round 3mm	\$32.00/ea

Buck Ear Curette **BUY NOW**

Vendor	Item#	Details	Price
INTEGRA/MILTEX	MIL19-294	6-1/2", Angled Blunt Size 1	\$37.71/ea
	MIL19-296	Ang Blunt Size 2	\$37.71/ea
JORGENSEN	JOR49F	Straight, Stainless steel, 6"	\$12.00/ea
	JOR49FG	Straight, German-made, 6"	\$18.00/ea/ea
	JOR49G	Curved head, 6"	\$12.00/ea/ea

Curette (without hole) **BUY NOW**

Vendor	Item#	Details	Price
INTEGRA/MILTEX	MIL40-57/3	large, 2.5 mm diameter	\$46.88/ea

Double Ended Disposable Ear Curettes

Vendor	Item#	Details	Price
JORGENSEN	JOR1059B	Curve Loop, 3pk	\$6.30/ea
	JOR1059C	Mini loop, 3pk	\$6.30/ea
	JOR1059A	Scoop End, 3pk	\$6.30/ea
	JOR1059	Set of 3	\$6.00/set

Double Ended Curette

Vendor	Item#	Details	Price
GERMAN	35-165	1.5 & 2.0mm Round Cups	\$25.00/ea
	35-167	2.5 & 3.5mm Round Cups	\$25.00/ea

Ferguson Stone Scoop

Vendor	Item#	Details	Price
JORGENSEN	JOR896	Stainless Steel	\$108.00/ea

BUY NOW

Fox Dermal Curette

Vendor	Item#	Details	Price
INTEGRA/MILTEX	MIL33-5B	5 1/2" (14 cm), round, 1 mm diameter	\$68.51/ea

Jorvet Hatt Spoon Curette **BUY NOW**

Vendor	Item#	Details	Price
JORGENSEN	JOR222P	12mm x 18mm scoop	\$73.00/ea
	JOR222N	17mm x 30mm scoop	\$73.00/ea
	JOR222O	7mm x 12mm scoop	\$73.00/ea

Jorvet House Curette **BUY NOW**

Vendor	Item#	Details	Price
JORGENSEN	JOR222H	2.5mm + 3.0mm ends	\$47.00/ea

Volkman Bone Curette **BUY NOW**

Vendor	Item#	Details	Price
JORGENSEN	JOR222A	Excellent for OCD lesions. Oval cutting surface. - made. Stainless steel. 22cm., #000	\$37.50/ea
	JOR222B	Excellent for OCD lesions. Oval cutting surface. - made. Stainless steel. 22cm., #2	\$37.50/ea

Dermal Curette (Sterile Disposable) **BUY NOW**

Vendor	Item#	Details	Price
INTEGRA/MILTEX	MIL33-54	4mm, 50/pk	\$142.28/pk

Jorvet Avian Oral Speculum **BUY NOW**

Vendor	Item#	Details	Price
JORGENSEN	JOR51X	Small. 4 3/4" x 1/4". (i.e., parakeets)	\$10.50/ea
	JOR51Y	Medium. 4 3/4" x 3/8". (i.e., African grey parrots)	\$12.30/ea
	JOR51Z	Large. 7 1/2" x 5/8". (i.e., full-size macaws)	\$15.30/ea
	JOR51S	Set of 3	\$30.00/set

Instruments

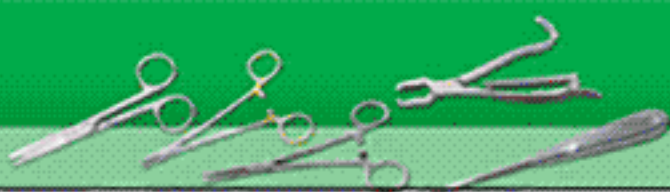

Retractors

Alm Retractor Sharp

Vendor	Item#	Details	Price
JORGENSEN	JOR244A	Small excels or avian pelorits, Stainless steel, 2 1/4" (7cm).	\$38.00/ea

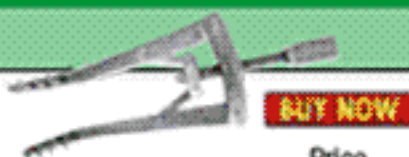

Balfour Retractor

Vendor	Item#	Details	Price
GERMAN	25-170	7" spread	\$180.00/ea
JORGENSEN	JOR242L	(A) 180mm (B) 45 x 80mm 180mm, 45 x 80mm	\$240.00/ea



Baby Balfour Retractor

Vendor	Item#	Details	Price
GERMAN	25-170A	4" spread	\$180.00/ea

JORGENSEN JOR242 for most small animals under 60 lbs. Works well for most small animals under 60 lbs.



Barraquer Retractor

Vendor	Item#	Details	Price
GERMAN	33-100	1.75" small blades 10mm wide	\$13.00/ea



Barraquer Eyelid Speculum

Vendor	Item#	Details	Price
INTEGRA/MILTEX	MIL18-36	1-1/4" (3.2 cm), small blades 10 mm wide, non-magnetic	\$59.51/ea



Castroviejo Eye Speculum

Vendor	Item#	Details	Price
GERMAN	20-105	3.5"	\$98.00/ea

Covault Retractor

Vendor	Item#	Details	Price
GERMAN	27-501	7"	\$30.00/ea



Eyelid Retractor

Vendor	Item#	Price
JORGENSEN	JOR68	\$30.00/ea



Gelpi Retractor

Vendor	Item#	Details	Price
ECONOMY	22-120	6.75"	\$52.00/ea
GERMAN	22-135	3.5"	\$75.00/ea
	22-137	5.5"	\$75.00/ea
	22-150	7.5"	\$75.00/ea
JORGENSEN	JOR240	18cm (7")	\$96.00/ea

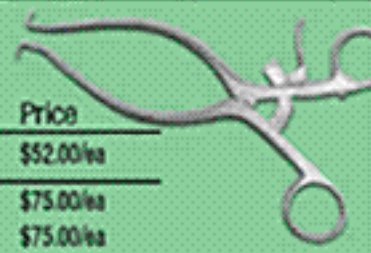

Mini Gelpi Retractor

Vendor	Item#	Details	Price
JORGENSEN	JOR240ME	Economy	\$36.00/ea
	JOR240M	German	\$123.00/ea
	JOR240S	Small	\$87.00/ea



Super Mini Gelpi Retractor

Vendor	Item#	Price
JORGENSEN	JOR240MA	\$59.00/ea



Gillies Retractor Fine

Vendor	Item#	Details	Price
JORGENSEN	JOR243G	7" (18cm).	\$27.00/ea



Harrington Retractor

Vendor	Item#	Details	Price
INTEGRA/MILTEX	MIL11-316	12"	\$313.68/ea



Hauptman OHE Retractor

Vendor	Item#	Details	Price
JORGENSEN	JOR925	Cat/Small Dog	\$119.00/ea
	JOR925X	CD ROM Instructions	\$3.00/ea
	JOR925B	Large Dog	\$119.00/ea
	JOR925A	Medium Dog	\$119.00/ea
	JOR925C	Set of 3	\$321.00/ea



Heaney Retractor

Vendor	Item#	Details	Price
INTEGRA/MILTEX	MIL11-182	10-1/2" (26.7 cm), blade 1-1/8" (2.8 cm) x 2-7/8" (7.3 cm)	\$145.43/ea



Hohman Retractor

Vendor	Item#	Details	Price
GERMAN	V-450A	12mm	\$32.00/ea
	V-450B	18mm	\$38.00/ea
JORGENSEN	JOR235A	12mm W x 24cm L (9"). Medium breeds	\$67.00/ea
	JOR235B	18mm W x 24cm L (9 1/2"). Large breeds	\$61.00/ea
	JOR235C	8mm	\$61.00/ea



Mini Hohman Retractor

Vendor	Item#	Details	Price
GERMAN	33-361	6.5" x 8mm	\$30.00/ea
JORGENSEN	JOR235M	6mm x 16cm	\$46.50/ea



Super Mini 4mm Hohman Retractor

greatly improve exposure and access in the small surgical field of joint surgery. Stainless steel.

Vendor	Item#	Price
JORGENSEN	JOR235MA	\$62.00/ea

Dandy Nerve Hook

Vendor	Item#	Details	Price
MILTEX	MIL26-1150	9" (22.9 cm), straight	\$75.30/ea



Instruments

Retractors & Specula

Lip Retractor

BUY NOW



Vendor	Item#	Details	Price
JORGENSEN	JOR1056	6 1/2" long and autoclavable.	\$21.00/ea

DesMarres Lip Retractor



Vendor	Item#	Details	Price
JORGENSEN	JOR243B	10mm, 16cm (6 1/4")	\$30.00/ea
BUY NOW	JOR243C	12mm, 16cm (6 1/4")	\$30.00/ea
	JOR243A	8mm, 16cm (6 1/4")	\$30.00/ea

The Lone Star Veterinary Retractor System

The Lone Star Veterinary Retractor System consists of two components, the autoclavable plastic ring and the accessory elastic stays. Because of its unique design, the retractor ring easily can be adapted to the patient's anatomy. The elastic stays allow the surgeon flexibility over the amount of tension applied and precise retraction of the incision without obstruction. Prep and drape patient in usual manner, then apply the retractor.

BUY NOW



Vendor	Item#	Details	Price
JORGENSEN	JOR4407	Retractor Ring Only, Small	\$132.00/ea
	JOR4405	Retractor Ring Only, Large	\$141.00/ea
	JOR4411	Elastic Stays Only, 8 Pack	\$71.00/ea

Retractor Guards

Vendor	Item#	Details	Price
JORGENSEN	JOR929	Assorted pack of 3 sizes	\$27.00/ea

Ribbon Retractor **BUY NOW**

Vendor	Item#	Details	Price
INTEGRA/MILTEX	MIL11-130	3/4" x 13"	\$36.98/ea

Baby Ribbon Retractor

Vendor	Item#	Details	Price
INTEGRA/MILTEX	MIL11-144	5/8" x 8"	\$34.96/ea

Skin Retractor **BUY NOW**

Vendor	Item#	Details	Price
ECONOMY	12-1465	5"	\$3.90/ea
MID GRADE	12-1465-S	6.25", Economy, Satin Finish	\$4.95/ea
GERMAN	27-502	4.75"	\$17.00/ea

Senn Retractor **BUY NOW**

Vendor	Item#	Details	Price
ECONOMY	12-1450	6.25" Sharp	\$4.30/ea
	12-1455	6.25" Blunt	\$4.95/ea
GERMAN	21-332	6.25" Sharp	\$18.00/ea
	21-333	6.25" Blunt	\$18.00/ea
INTEGRA/MILTEX	MIL11-76	6.25 Sharp	\$60.75/ea

Senn Retractor w/Blunt Prongs

Vendor	Item#	Details	Price
JORGENSEN	JOR243B	16cm (6 1/4")	\$10.00/ea

Senn-Mueller Retractor **BUY NOW**

Double end retractor. Three sharp hooks on one end and a wide plate on the other end.

Vendor	Item#	Details	Price
JORGENSEN	JOR243	16cm (6 1/4")	\$12.00/ea

Snook Retractor

Vendor	Item#	Details	Price
ECONOMY	1-100	8"	\$6.95/ea
GERMAN	27-500	8"	\$17.00/ea
	27-500SM	8" small hook	\$26.50/ea
	27-500N	8" Narrow pattern hook	\$25.00/ea
	27-500W	8" Wide pattern hook	\$25.00/ea
INTEGRA/MILTEX	MIL6-008	8"	\$63.91/ea

Spay Hook

Vendor	Item#	Details	Price
JORGENSEN	JOR112A	Snook, Flat, Stainless Steel, 8"	\$14.85/ea

Stifle Lever

Examination and management of meniscal injuries is made extremely difficult by the limited access to the medial meniscus during routine approaches. Exposure of the medial meniscus is typically achieved by either use of a stifle distractor or by a Hohman retractor. Hohman retractors are not designed for levering against articular cartilage in that the blade does not "fit" the trochlea. The stifle lever is designed to substitute the Hohman. The caudal surface of the stifle lever is contoured to fit the trochlea of large dogs. The load is dissipated over a large area minimizing trauma. The ring style handle is convenient for retraction by the surgeon using the thumb. The tip atraumatically hooks behind the caudal aspect of the tibial plateau.

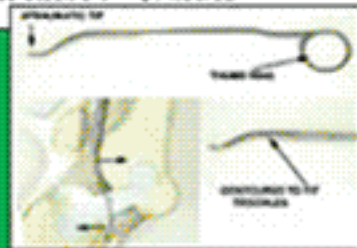

Vendor	Item#	Details	Price
JORGENSEN		9" (225mm) length.	\$61.00/ea

Stifle Fat Pad Retractor **BUY NOW**

Vendor	Item#	Details	Price
JORGENSEN	JOR243A	16cm (6 1/4")	\$21.00/ea

Retractors/Orthopedic & OB - Wire Products

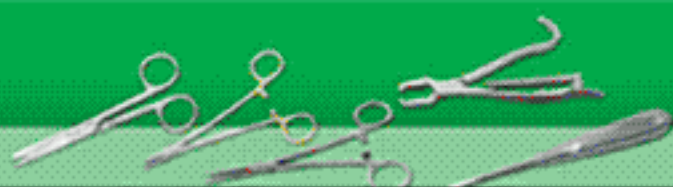

Jorvet Stifle Retractor

BUY NOW



Vendor	Item#	Price
JORGENSEN	JOR240W	\$210.00/ea

Jorvet Small Stifle Retractor

The examination of the meniscus and intraarticular structure during anterior cruciate repair is a real necessity. This visualization often is difficult even in the largest of dogs. The stifle retractor allows gentle retraction between the femur and tibia, exposing the entire stifle joint to a thorough exam without damaging the joint surface. Stainless steel.

Vendor	Item#	Details	Price
JORGENSEN	JOR240WA	6mm profile. The small overlapping tips allow atraumatic entry into small arthrotomies and small stifles.	\$161.00/ea
	JOR240WB	Tips differ by the smaller 3mm versus 6mm profile of JOR240wa. (<50 Kg), X-Small	\$158.00/ea
	JOR235SA	6 1/2" (170mm)	\$61.00/ea

Stifle Distractor w/Spinlock

Jorvet

The working tips on our spinlock are the same as the ratchet version. The spinlock offers more secure distraction as it is less likely to slip. The spinlock also offers an infinite range of position versus the ratchet.

Vendor	Item#	Details	Price
JORGENSEN	JOR240WAS		\$180.00/ea
BUY NOW	JOR240WBS	X-Small	\$180.00/ea



U.S Army Retractor

BUY NOW

Vendor	Item#	Details	Price
ECONOMY	22-112	8.5"	\$21.50/ea
GERMAN	22-111	8.5"	\$28.00/ea
INTEGRA/MILTEX	MIL11-122	8.5"	\$94.71/ea

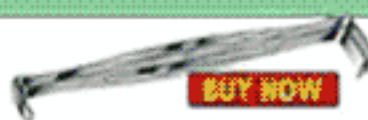

Weitlaner Retractor

BUY NOW

Vendor	Item#	Details	Price
ECONOMY	12-1460	5.5"	\$30.00/ea
JORGENSEN	JOR241E	18cm (7"), Economy	\$43.50/ea
	JOR241	18cm (7"), Stainless Steel, Blunt hooked retractor-made.	\$96.00/ea
MID GRADE	12-1460-S	5.5", Satin Finish	\$33.00/ea
GERMAN	21-316	5.5" 3x4 Sharp	\$55.00/ea
	21-316B	5.5" 3x4 Blunt	\$55.00/ea
	21-317	6" 3x4 Teeth, Blunt	\$58.00/ea



Super Mini Weitlaner Retractor

BUY NOW

Stainless steel. Blunt hooked retractor. German-made.

Vendor	Item#	Details	Price
JORGENSEN	JOR241MA	18cm (7"), 3 5/8"	\$61.00/ea

Jorvet Cerclage Wire Passer

BUY NOW

This is a simple instrument for passage of cerclage wire around fracture sites. Stainless steel. 15cm.

- Minimizes trauma to surrounding tissue
- Saves surgical time
- Double-ended for a whole range of bone sizes

Jorvet

Vendor	Item#	Price
JORGENSEN	JOR217	\$42.00/ea



Jorvet Curved Graft Passer

BUY NOW

Vendor	Item#	Details	Price
JORGENSEN	JOR236	Large, 4.5cm dia. head, 17cm L	\$101.00/ea
	JOR236S	Small, 3.0cm dia. head, 15cm L	\$95.00/ea
	JOR236L	X-Large, 6.0cm dia. head	\$101.00/ea
	JOR236XS	X-Small, 2.0cm dia. head.	\$106.00/ea
	JOR236XL	XX-Large, 8.0cm dia. head	\$109.00/ea



BUY NOW

Jorvet Cerclage Wire

Vendor	Item#	Details	Price
JORGENSEN	JOR260A	18g x 10m	\$10.20/ea
	JOR260B	20g x 10m	\$10.20/ea
	JOR260C	22g x 10m	\$10.20/ea
	JOR260D	24g x 10m	\$10.20/ea
	JOR260E	26g, 10m	\$10.20/ea
	JOR260F	28g, 10m	\$10.20/ea



Cerclage Wire Tightener

Vendor	Item#	Details	Price
JORGENSEN	JOR218L	5"L	\$178.00/ea

BUY NOW

Cerclage Wire Eyelet

Vendor	Item#	Details	Price
JORGENSEN	JOR260AL	18g, 6 pack	\$15.00/pk
	JOR260BL	20g, 6 pack	\$15.00/pk

BUY NOW

Jorvet

Cerclage Wire Button

Jorvet

Vendor	Item#	Details	Price
JORGENSEN	JOR260X	Fits 3.5mm DCP holes.	\$29.00/ea

BUY NOW



Double Loop Cerclage Wire Tightener

Jorvet

Vendor	Item#	Price
JORGENSEN	JOR218LD	\$140.00/ea

BUY NOW



Meniscus Knife

BUY NOW

Vendor	Item#	Details	Price
JORGENSEN	JOR236M	15cm	\$102.00/ea

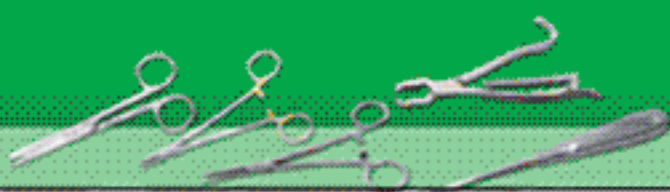

Orthopedic & OB - Wire Products

Gigli Saw Handles **BUY NOW**

Vendor	Item#	Details	Price
GERMAN	13-213	German	\$24.00/ea
INTEGRA/MILTEX	MIL26-119	Handles	\$161.76/ea
JORGENSEN	JOR107H	Wire Only	\$11.10/ea



Gigli Wire **BUY NOW**

Vendor	Item#	Details	Price
GERMAN	33-180	12"	\$17.00/ea
	33-182	20"	\$17.00/ea
	MIL26-130	12"	\$11.16/ea
	MIL26-132	20"	\$13.30/ea
JORGENSEN	JOR107	52 cm. Wire Only	\$9.00/ea

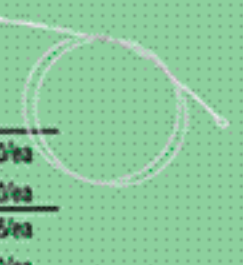

Gigli Saw Set **BUY NOW**

Vendor	Item#	Details	Price
GERMAN	GIGLI-GER	Includes 2 gigli handles and a 12" & 20" saw wire	\$50.00/ea

Modified Gigli Bone Saw **BUY NOW**

Locking clip holds wire in proper position.

Vendor	Item#	Price
JORGENSEN	JOR107M	\$9.00/ea



K-Wire Bender **BUY NOW**

Vendor	Item#	Details	Price
JORGENSEN	JOR211	Bender	\$66.00/ea



K-Wire Cutter **BUY NOW**

Vendor	Item#	Details	Price
GERMAN	V-400	Tc Jaw, 9"	\$199.00/ea
JORGENSEN	JOR2208A	8.5"	\$210.00/ea
	JOR2208B	Tungsten Carbide Inserts, Cuts wire up to 2.2mm. 9"L.	\$210.00/ea
	JOR49C	Wire Cutter with notched cutout. Stainless steel. Also useful for cutting suture wire.	\$20.70/ea

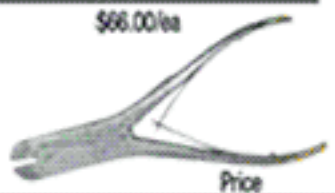

K-Wire Extraction Forceps **BUY NOW**

Vendor	Item#	Details	Price
JORGENSEN	JOR2110	5 1/2"	\$77.00/ea



K-wire Storage Dispenser **BUY NOW**

Vendor	Item#	Details	Price
JORGENSEN	JOR2500	Stainless Steel, Autoclavable	\$145.00/ea



Jorvet K-wire/Small Pin Punch Smaller **BUY NOW**

Vendor	Item#	Details	Price
JORGENSEN	JOR215A	Small, 1.6mm fine tip.	\$54.00/ea



Hauptner OB wire **BUY NOW**

Vendor	Item#	Details	Price
JORGENSEN	JOR18H	10 meters	\$27.00/ea



Lyss OB Handle **BUY NOW**

Vendor	Item#	Details	Price
JORGENSEN	JOR21L	Stainless Steel, 3"L.	\$24.00/ea



Jorvet Ob Saw Wire **BUY NOW**

Vendor	Item#	Details	Price
JORGENSEN	JOR18	11 yards	\$15.60/ea



Jorvet Ob Saw Set **BUY NOW**

Vendor	Item#	Details	Price
JORGENSEN	OB-1	Includes one handle and 11 yds of wire saw.	\$21.00/ea
INTEGRA/MILTEX	GIGLI-MIL	Includes one handle and 11 yds of saw wire	\$100.00/ea



Jorvet Ob Wire Handle **BUY NOW**

Sold Individually
this is not a pair

Vendor	Item#	Details	Price
JORGENSEN	JOR21H	3.5" long One Handle	\$12.00/ea
	JOR21S	Knurled no slip grip, 4" long One Handle	\$19.50/ea

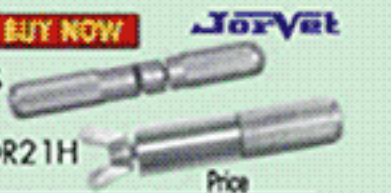

Jorvet OB Drop Wire Guide **BUY NOW**

This is an excellent guide, as it is heavy enough and shaped to permit easier passage around the fetal part. Stainless Steel. 3 1/2"L.

Vendor	Item#	Details	Price
JORGENSEN	JOR200	Stainless Steel, 3 1/2"L.	\$9.00/ea



Jorvet OB Wire Guide **BUY NOW**

Wire is pushed into the end of the guide and fastened. The weighted ball end drops easily over the animal.

Vendor	Item#	Details	Price
JORGENSEN	JOR20H	Hauptner, 7"L.	\$52.50/ea



Instruments

Orthopedic & OB - Wire Products

Jorvet OB Chain

Plated, 45"

Vendor	Item#	Details	Price
JORGENSEN	JOR24WH	Plated 45"	\$8.40/ea
	JOR24WS	Plated, 30"	\$7.50/ea
	JOR24WL	Plated, 60"	\$10.50/ea
	JOR24GS	Stainless Steel, 30"	\$52.50/ea
	JOR24GL	Stainless Steel, 60"	\$61.50/ea



BUY NOW

OB Chain Handles

Moore's OB Chain Handle. Stainless steel.

Vendor	Item#	Details	Price
JORGENSEN	JOR24W	Stainless Steel	\$10.50/ea
	JOR23S	Stainless Steel	\$8.70/ea
	JOR24WM	Stainless Steel w. plastic Laminate Handles	\$9.00/ea

Jorvet T-bar OB handle

Allows for use of both hands for pulling. Handle 22cm L.

Vendor	Item#	Price
JORGENSEN	JOR24T	\$25.50/ea

Steel Stainless K-Wire

Highest quality stainless steel type 316LVM. U.S.A. made. Double Trocar Point.

Vendor	Item#	Details	Price
JORGENSEN	JOR250PA	.062 x 7", double point, single	\$3.10/ea
	JOR250MA	.035 x 7"	\$3.10/ea
	JOR250NA	Single, .045 x 7"	\$3.00/ea

Small Pin Vise

3 fl" L holds small K-wires and pins up to 2.5mm (3/32")

Vendor	Item#	Details	Price
JORGENSEN	JOR214K	3 fl" L holds small K-wires and pins up to 2.5mm (3/32")	\$78.00/ea

Swedish OB Wire Handle and Wire Container

BUY NOW

Serves both as a handle and also as a handy dispenser.

Vendor	Item#	Details	Price
JORGENSEN	JOR21	Serves both as a handle and also as a handy dispenser.	\$39.00/ea

BUY NOW

Wire Twister/Shear Cutter

Vendor	Item#	Details	Price
JORGENSEN	JOR218	15cm	\$93.00/ea

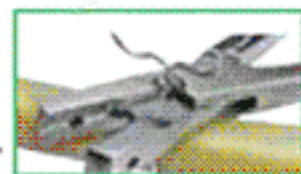

Wire Twister

Vendor	Item#	Details	Price
JORGENSEN	JOR215L	7" long	\$73.00/ea



BUY NOW

Wire Twister/Cutter

Vendor	Item#	Details	Price
German	33-195	Twister/Cutter	\$70.00/ea



Wire Passer

Vendor	Item#	Details	Price
GERMAN	V-100	15cm length, double sided curves, 3cm diam and 4cm diam,	\$13.00/ea
JORGENSEN	JOR221	3 sizes of hollow needles	\$148.00/ea



Jorvet

Ophthalmic Surgery Pack

Kit contains the specialized instruments necessary to complete the more common eye surgical procedures. Just wrap with drape.

Vendor	Item#	Details	Price
JORGENSEN	JOR664	Kit Includes: JOR232 Castroviejo, JOR680 Chalazion Forceps, JOR680W Eye Lid Retractor, JOR231 Castroviejo Needle Holders, JOR5WC Iris Scissors, JOR55GA #3 Scalpel Handle, Tray Not Included	\$230.00/ea
	JOR664K	Kit Includes: JOR232 Castroviejo, JOR680 Chalazion Forceps, JOR680W Eye Lid Retractor, JOR231 Castroviejo Needle Holders, JOR5WC Iris Scissors, JOR55GA #3 Scalpel Handle, JOR664T Autoclave Tray (w. rubber mat)	\$299.00/ea

Behney Ear Instrument

Helps to avoid the problems associated with external bracing of cropped ears. Also very effective for getting problem ears to stand. Detailed literature and pictures available on request. Instrument consists of trocar, push rod, cannula, and wire implants. Two of each size.

Vendor	Item#	Details	Price
JORGENSEN	JOR498	Stainless Steel	\$81.00/ea



Instruments

OB & Orthopedic

Jorvet Balling Gun



BUY NOW

Jorvet

Vendor	Item#	Details	Price
JORGENSEN	JOR185S	1-1/2" Head, 5/8" Diameter	\$17.40/ea
	JOR185	2 3/8" Head, 1" Diameter	\$20.10/ea
BUY NOW	JOR185P	2-1/2" Head, 7/8" Diameter	\$30.00/ea

Jorvet Bone Saw



Vendor	Item#	Details	Price
JORGENSEN	JOR219	With 5 Blades	\$104.00/ea
	JOR219D1	5 pack Replacement Blades	\$30.00/ea
BUY NOW		15cm-19cm (5 1/2 x 7 1/2)	

Hard-back Orthopedic Saw

Jorvet



Vendor	Item#	Details	Price
JORGENSEN	JOR219K	140mm long x 23mm deep with 0.4mm cut.	\$31.00/ea

Bone Tunnel Borer

BUY NOW

Jorvet

Vendor	Item#	Details	Price
JORGENSEN	JOR236T	2.7mm	\$81.00/ea
	JOR236TC	w/Counter Sink	\$102.00/ea

Cable Swine Snare

BUY NOW

Jorvet

Vendor	Item#	Details	Price
JORGENSEN	JOR22C	Swine Cable OB Snare.	\$53.00/ea

Cast Spreader

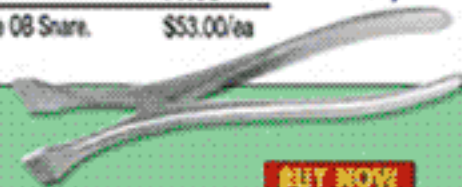

BUY NOW

Vendor	Item#	Details	Price
GERMAN	V-265	12"	\$180.00/ea
INTEGRA/MILTEX	MIL27-3090	12"	\$264.12/ea

Cast Cutter



BUY NOW

Vendor	Item#	Details	Price
GERMAN	V-260	5.75"	\$42.00/ea
MILTEX	MIL27-3020	5.75"	\$238.92/ea

Heavy duty bandage/Cast Cutter

BUY NOW

Vendor	Item#	Details	Price
JORGENSEN	JOR74HB	8 1/2"	\$51.00/ea

Jorvet Castroviejo Caliper

BUY NOW



Vendor	Item#	Details	Price
JORGENSEN	JOR232C	German-made. Stainless steel.	\$210.00/ea

OB Calving Strap

Jorvet

High-quality tubular nylon strap with "D" ring. This strap is less traumatic to the unborn calf than steel chains. Royal blue. 1"W.

BUY NOW

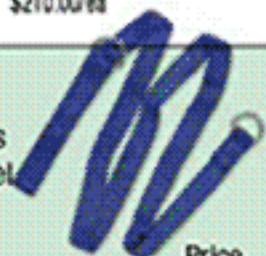

Vendor	Item#	Details	Price
JORGENSEN	JOR24XS	High quality tubular nylon strap with "D" ring, 1"W, 30"	\$11.35/ea
	JOR24XL	High quality tubular nylon strap with "D" ring, 1"W, 60"	\$11.25/ea

Dome Catheter

INTEGRA Miltex

BUY NOW

Vendor	Item#	Details	Price
INTEGRA/MILTEX	MIL3-944	15-13/16"x3-1/32"x29/32"	\$28.59/ea

Embryotomy Knife

Jorvet

Vendor	Item#	Details	Price
JORGENSEN	JOR17	Gunther, 2 1/2"L.	\$33.00/ea

Emmett Uterine Tenaculum Hook

INTEGRA Miltex

Vendor	Item#	Details	Price
INTEGRA/MILTEX	MIL30-951	9" (22.9 cm), style 1, half-curved, small	\$77.95/ea

Femoral Disarticulator

Vendor	Item#	Details	Price
JORGENSEN	JOR233	Small 5.5"	\$66.00/ea
	JOR233B	Large 7.75"	\$96.00/ea



Feline/Canine Gags

Feline

Vendor	Item#	Details	Price
JORGENSEN	JOR51F	Stainless Steel, 3"	\$10.80/ea
	JOR51FD1	Inserts, Pair, Feline	\$3.30/ea

Canine

Vendor	Item#	Details	Price
JORGENSEN	JOR51C	Large, 6 3/4"	\$15.60/ea
	JOR51A	Small, 4 1/2"	\$14.70/ea
	JOR51B	Medium, 5"	\$15.00/ea
	JOR51D1	Inserts, Pair, Canine	\$3.30/ea

Smith-Baxter Mouth Gag

Vendor	Item#	Details	Price
JORGENSEN	JOR51SBC	Large	\$18.00/ea
	JOR51SBB	Medium	\$15.00/ea
	JOR51SBS	Set of 4	\$66.00/ea
	JOR51SBA	Small	\$15.00/ea
	JOR51SBD	X-large	\$21.00/ea

Instruments

OB & Orthopedic

Graefe's Eye Speculum



BUY NOW

Vendor	Item#	Details	Price
JORGENSEN	JOR68G	for small animals	\$15.00/ea

Graft Passer with Small Eye

BUY NOW

Vendor	Item#	Details	Price
JORGENSEN	JOR236SE	6"L, Stainless Steel	\$95.00/ea

Graves Vaginal Speculum

Vendor	Item#	Details	Price
ECONOMY	10-271	Medium	\$6.95/ea



BUY NOW

Grooved Probe Director

Vendor	Item#	Details	Price
JORGENSEN	JOR92P	Stainless steel, 5"	\$4.50/ea



JorVet

BUY NOW

Gerzog Bone Mallet

JorVet

BUY NOW

Vendor	Item#	Details	Price
GERMAN	21-277	7.5", 8oz Head	\$62.00/ea
INTEGRA/MILTEX	MIL19-790	7.5", 8oz head	\$166.22/ea
JORGENSEN	JOR226M	18cm (7 1/4")-made, Stainless steel	\$54.00/ea



Mead Mallet

JorVet

BUY NOW

With hardened nylon face. Replaceable 26mm dia. mallet face. Weighs 320gm. 6 3/4" (17cm) L.

Vendor	Item#	Details	Price
JORGENSEN	JOR226X	With hardened nylon face. Replaceable 26mm dia. mallet face. Weighs 320gm. 6 3/4" (17cm) L.	\$92.00/ea
GERMAN	33-360	Stainless Steel, 7.5"	\$92.00/ea



Mead Mallet (Spare Face)

BUY NOW

Vendor	Item#	Details	Price
JORGENSEN	JOR226XD1	Spare Face	\$18.00/ea



Percussion Mallet

Vendor	Item#	Details	Price
JORGENSEN	JOR894E	Economy, Stainless Steel	\$6.30/ea

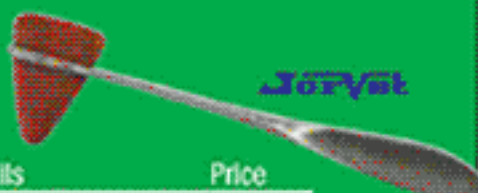

JorVet

BUY NOW

Nasal Speculum

JorVet

BUY NOW

Vendor	Item#	Details	Price
ECONOMY	10-1080	Child 5.5"	\$9.00/ea
	10-1085	Adult	\$9.00/ea
MID GRADE	10-1085-S	5.5", Satin Finish	\$12.00/ea
	10-1080-S	5.5", Satin Finish	\$12.00/ea
GERMAN	21-240	Infant	\$25.00/ea
	21-242	Small	\$36.00/ea
	21-244	Medium	\$36.00/ea



Orthopedic Distractor

BUY NOW JorVet

Can be used with ESF Pins 3.2-4.0mm. Distractors are useful instruments for the proper repositioning and compression of long bone fractures. The distractor will hold the bone in anatomical alignment and allow the placement of either bone plates, K-E external fixation devices, or bone screws. The instrument will greatly reduce the amount of manipulation that goes on when trying to maintain alignment during surgery, and allows the surgeons to concentrate their efforts on applying the proper fixation device.

Vendor	Item#	Details	Price
JORGENSEN	JOR237	use with ESF Pins 3.2-4.0mm	\$610.00/ea



Reduction Forceps with Spinlock

BUY NOW

Spin lock. Provides incremental secure control, round ends.

Vendor	Item#	Details	Price
JORGENSEN	JOR2126S	Standard, 6" (15cm).	\$110.00/ea
JORGENSEN	JOR159RF	Spin lock. Provides incremental secure control, round ends, serrated Jaws 16cm	\$102.00/ea

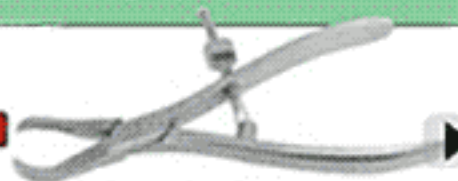

Rib Cutter/Shearer

BUY NOW

Cuts through rib cage on small animals and younger large animals. German-made. Stainless steel.

Vendor	Item#	Details	Price
JORGENSEN	JOR508	9" length	\$124.00/ea



Finocchio Rib Spreader

BUY NOW

Vendor	Item#	Details	Price
JORGENSEN	JOR2420	8" (20.3cm) spread, 65mm W x 48mm D blades.	\$509.00/ea



Mini Finocchio Rib spreader

Vendor	Item#	Details	Price
JORGENSEN	JOR2420M	3" (75mm) spread, 20mm W x 18mm D blades.	\$263.00/ea



OB & Orthopedic



Strawberry Roaring Burr



BUY NOW

Vendor	Item#	Details	Price
JORGENSEN	JOR62ST	8.5" Stainless Steel	\$30.00/ea

Sharpening Steel

BUY NOW



Vendor	Item#	Details	Price
JORGENSEN	JOR902	Sharpening stone	\$24.00/ea
	JOR902S	Sharpening stone	\$16.50/ea

T-Bar Swine Snare

BUY NOW



Vendor	Item#	Details	Price
JORGENSEN	JOR22T	10" L shaft.	\$49.00/ea

Tail Docker

BUY NOW



Vendor	Item#	Details	Price
JORGENSEN	JOR176	Tail Docker	\$101.00/ea

Slocum/TPLO Rotation Gauge

BUY NOW



Vendor	Item#	Details	Price
JORGENSEN	JOR822F	rotation gauge	\$101.00/ea

Taylor Hammer

BUY NOW

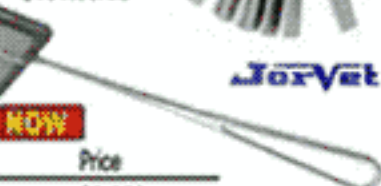

Vendor	Item#	Details	Price
ECONOMY	11-1275	Chrome, 7.5"	\$3.95/ea
JORGENSEN	JOR894		\$15.60/ea

Umbilical Tape

BUY NOW



Vendor	Item#	Details	Price
JORGENSEN	JOR25UC	Non-Sterile, 1/4" X 20 ydev	\$6.10/ea

Jorvet Umbilical Clamps

BUY NOW



Vendor	Item#	Details	Price
JORGENSEN	JOR56B	Non-Sterile	\$22.50/ea
	JOR56	Sterile Umbilical Clamp helps prevent navel infection. Self-locking; disposable plastic.	\$0.96/ea

Umbilical Huston Hernia Clamp

Vendor	Item#	Details	Price
JORGENSEN	JOR56HA	Huston Hernia Clamp. 5" Swine Hernia Clamp. 5"	\$9.00/ea
JORGENSEN	JOR56HB	Huston Hernia Clamp. 7" Swine Hernia Clamp. 7"	\$10.50/ea

BUY NOW

Jorvet Trocar-Trocar I. M. Pins

BUY NOW

Highest quality type 316L stainless steel IM pins. Available in the points and diameters listed below. When ordering, please match diameter with point style number. Made in U.S.A.

Vendor	Item#	Details	Price
JORGENSEN	JOR250E	1/8" x 9"	\$9.00/ea
	JOR250C	3/32" x 8"	\$7.20/ea
	JOR250G	5/32" x 10"	\$8.85/ea
	JOR250B	5/64" x 7"	\$4.65/ea
	JOR250D	7/64" x 8"	\$9.00/ea
	JOR250F	9/64" x 9"	\$6.90/ea



Check our Orthopedic Section for a Full line of Pins and Plates

Pin Removal Forceps

BUY NOW

Pin removal is made easy with this forceps. Also useful for bending, holding, and cutting small pins and wires. Parallel action pliers may be used in tandem with bone plate bender for contouring smaller plates.



Vendor	Item#	Details	Price
JORGENSEN	JOR442	Stainless Steel, w/Wire Cutter	\$252.00/ea

Enclosed Bone Pin Cutter

BUY NOW

Vendor	Item#	Details	Price
JORGENSEN	JOR220P	up to 4mm (5/32")	\$224.00/ea

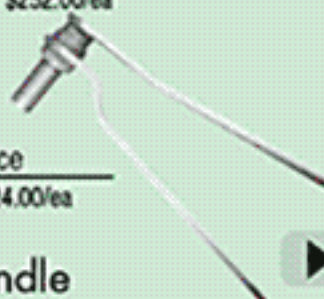

Pincutter with Breakdown Handle

Large pin cutter similar to JOR220 only handles detach to fit into smaller autoclaves. From 490mm (19 3/8") to 260mm (10 3/8"). Gold colored handles with tungsten carbide inserts.

Vendor	Item#	Price
JORGENSEN	JOR2200	\$340.00/ea



Pin Cutter

BUY NOW

Vendor	Item#	Details	Price
GERMAN	V-105	19"	\$249.00/ea

BUY NOW

Jorvet Bone Pin Counter Punch

BUY NOW

Vendor	Item#	Price
JORGENSEN	JOR215	\$52.00/ea



Small Lowman Bone Clamp

Developed from standard human Lowman clamp. This clamp grips bone up to 15mm diameter and will also hold small plates in position.

Vendor	Item#	Details	Price
JORGENSEN	JOR2130	3" (70mm) length.	\$120.00/ea

BUY NOW

Instruments

OB & Orthopedic/Biopsy Instruments/Hoof Care



Jorvet Hoof Knife

BUY NOW

JOR32 Series



Jorvet

Vendor	Item#	Details	Price
JORGENSEN	JOR32HLE	Left, Economy, Ebony	\$9.75/ea
	JOR32HRE	Right, Economy, Ebony	\$9.75/ea
	JOR34CLE	5/8"W x 2 1/2"L, Left, Economy	\$9.90/ea
	JOR34CRE	5/8"W x 2 1/2"L, Right, Economy	\$9.90/ea
	JOR34CN	3/8" blade (left or right)	\$19.50/ea
	JOR34CNLE	3/8", Left, Economy	\$9.00/ea
	JOR34CNRE	3/8", Right, Economy	\$9.00/ea
	JOR34K	Left or Right	\$15.00/ea



Left Curved Hoof Knife

BUY NOW

Jorvet



Vendor	Item#	Details	Price
JORGENSEN	JOR32HML	Wood Handle, Left, Curved, Blade 5/8" W x 2 3/4"L.	\$30.90/ea

Jorvet Hoof Knife Set

BUY NOW

Vendor	Item#	Details	Price
JORGENSEN	JOR32HSE	Economy	\$60.00/ea

Jorvet



Jorvet Oval Hoof Knife

BUY NOW

Jorvet

Vendor	Item#	Price
JORGENSEN	JOR340	\$38.00/ea



Jorvet Hoof Knife Hone

BUY NOW

Jorvet

Vendor	Item#	Price
JORGENSEN	JOR33H	\$13.50/ea



Swiss Knife

BUY NOW

Jorvet



Vendor	Item#	Details	Price
JORGENSEN	JOR32E	7.25"	\$27.50/ea

Hughes hoof groover



BUY NOW

Vendor	Item#	Details	Price
JORGENSEN	JOR32HG	6 1/4"(16cm) L.	\$18.00/ea

Hoof Blade



BUY NOW

Vendor	Item#	Details	Price
JORGENSEN	JOR34S	2.5" Blade, 6"	\$9.00/ea

Clinch Cutter

BUY NOW



Vendor	Item#	Details	Price
JORGENSEN	JOR1024C	6"	\$21.00/ea

Hoof Pick

BUY NOW



Vendor	Item#	Details	Price
JORGENSEN	JOR32P	each	\$1.80/ea

Hoof Crease Nail Puller

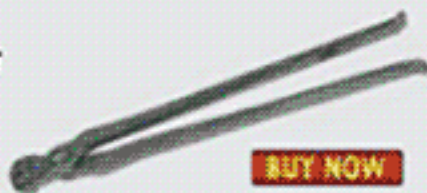

BUY NOW

Vendor	Item#	Price
JORGENSEN	JOR1024	\$39.00/ea

Small Loop Abscess Knife



BUY NOW

Vendor	Item#	Price
JORGENSEN	JOR34L	\$46.50/ea

Jorvet Lichy Knife

BUY NOW



Jorvet

Vendor	Item#	Details	Price
JORGENSEN	JOR9LS	5.5" Stainless Steel	\$15.90/ea

Danish Knife

BUY NOW



Vendor	Item#	Details	Price
JORGENSEN	JOR5	4.5" Handle, 2.5", Probe Point	\$15.00/ea

Jorvet Teat Blade



BUY NOW

Vendor	Item#	Details	Price
JORGENSEN	JOR8	7.5" Thin Model	\$51.00/ea

Hug's Blade

BUY NOW

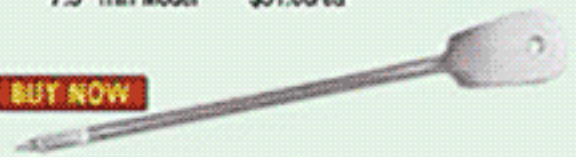

Vendor	Item#	Details	Price
JORGENSEN	JOR4	.5" Blade, 6" Handle	\$33.00/ea

Surgical Drill & Accessories & Rodent Instruments

Orthopedic Power Drill Set

A power driver with features making it the best on the market. The power source is a high quality cordless reversible Makita driver drill.

- Variable-speed 0-600 RPM vs. Standard model which has 100 or 200 RPM settings.
- No skating effect at start, when drill may skid or jump.
- 3 1/2" cannulated extension with 1/4" Jacobs chuck.
- Extension and chuck can be autoclaved separately.

The drill can be covered with an autoclaved shroud (order separately)
DO NOT AUTOCLAVE DRILL. BUY NOW

Vendor	Item#	Details	Price
JORGENSEN	JOR238	8 1/4"L. 2.2 lbs.	\$330.00/ea

Drill Shroud (Autoclavable) BUY NOW

Vendor	Item#	Details	Price
JORGENSEN	JOR238SD	Disposable, Sterile. 5/pk.	\$11.10/pk
	JOR238S	Will fit any standard size drill.	\$13.50/ea

Small Pin/Tap Chuck BUY NOW

for 2mm taps 4" length

Vendor	Item#	Details	Price
JORGENSEN	JOR214S	for 2mm taps 4" length	\$111.00/ea

Jacobs Pin Chuck BUY NOW

Vendor	Item#	Details	Price
JORGENSEN	JOR214LD1	Short chuck & key	\$112.00/ea

Small Jacobs Chuck JorVet

Lightweight blue anodized aluminum. 120g. 14cm.

- Much finer, more delicate, and less than half the weight of standard chucks
- Ideal for small dogs and cats when using "k" wires and small pins up to 5/32"
- Handle not slotted as JOR214L. BUY NOW

Vendor	Item#	Details	Price
JORGENSEN	JOR214	120g. 14cm	\$192.00/dz

Jorvet-Aesculap Saw Blades

Vendor	Item#	Details	Price
JORGENSEN	JOR238SB24	Radius 24mm	\$445.00/ea
	JOR238SB30	Radius 30mm	\$445.00/ea

JorVet BUY NOW

Jorvet Rodent Molar Cutter JorVet

Vendor	Item#	Price
JORGENSEN	JOR51RM	\$105.00/ea

BUY NOW

Rodent Mouth Gag BUY NOW

Examination of the rabbit mouth is virtually impossible without a gag of this type.

Vendor	Item#	Price
JORGENSEN	JOR51RG	\$75.00/ea

Lightweight Rodent Mouth Gag BUY NOW

Vendor	Item#	Price
JORGENSEN	JOR51RGS	\$60.00/ea

Nazzy Ferret Mouth Gag

A smaller version of the feline gag. This works very well on ferrets, kittens, and small puppies.

Vendor	Item#	Details	Price
JORGENSEN	JOR51G	1 1/8"	\$35.00/ea

BUY NOW

Rodent Tooth Rasp BUY NOW

Molar Rasp (rabbits). Unsuitable for debulking but good for removal of small spurs.

Vendor	Item#	Price
JORGENSEN	JOR51RR	\$60.00/ea

Rodent Cheek Dilator BUY NOW

The cheek dilator allows visualization of molars and protects cheeks from instruments.

Vendor	Item#	Details	Price
JORGENSEN	JOR51RDL	Large	\$21.00/ea
	JOR51RDLX	Large with long reach	\$21.00/ea

Jorvet Rodent Dental Spatula JorVet

BUY NOW

Used to deflect tongue and cheeks to enable best possible view of problems.

Vendor	Item#	Price
JORGENSEN	JOR51RS	\$24.00/ea

Biopsy Products/Castration Products

BUY NOW

Inexpensive Disposable Skin Biopsy Punch



JorVet

Vendor	Item#	Details	Price
JORGENSEN	JOR16304	4mm, 5pk.	\$16.20/pk
	JOR16306	6mm, 5pk.	\$16.20/pk
	JOR16308	8mm, 5pk.	\$16.50/pk

Keyes Biopsy Punch



Original round skin punches, knurled handle. Stainless steel. German-made. 4 1/2" (12cm).

BUY NOW

Vendor	Item#	Details	Price
JORGENSEN	JOR163B	8mm head	\$30.00/ea
	JOR163	Stainless Steel-made, 4 1/2" (12cm), 4mm head	\$28.50/ea
	JOR163A	Stainless Steel-made, 4 1/2" (12cm), 6mm head	\$28.50/ea

BUY NOW

Jackson-Chevalier Biopsy Forcep

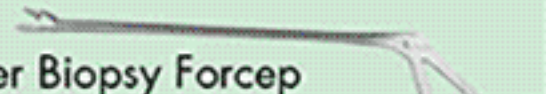

Vendor	Item#	Details	Price
JORGENSEN	JOR116JC		\$73.00/ea

BUY NOW

Uterine Biopsy Forcep

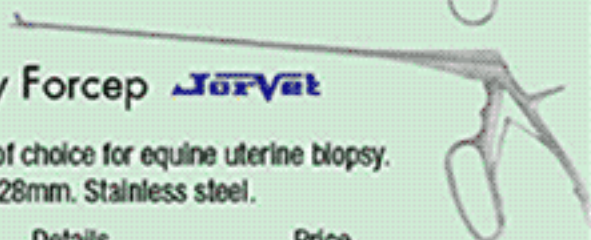

This is the instrument of choice for equine uterine biopsy. Cutting area is 4mm x 28mm. Stainless steel.

Vendor	Item#	Details	Price
JORGENSEN	JOR116/W	Shaft 60cm (23 1/2" L)	\$402.00/ea

JorVet BUY NOW

Soft Tissue Biopsy Alligator Forceps



Vendor	Item#	Details	Price
JORGENSEN	JOR117	2mm diameter, shaft is 10cm. Biopsy jaws 2 mm x 3.6 mm.	\$165.00/ea

Equine Uterine Biopsy Instrument

This biopsy instrument will separate into two parts allowing it to fit into the autoclave. Total length - 63cm (25") 3 finger ring configuration

Vendor	Item#	Price
JORGENSEN	JOR116J	\$82.00/ea

Van Buren Urethral Sound

INTEGRA Miltex

Vendor	Item#	Details	Price
INTEGRA/MILTEX	MIL29-6-24	11" (27.9 cm), 24 Fr. (8 mm)	\$80.02/ea

BUY NOW



Killian Speculum



Vendor	Item#	Price
JORGENSEN	JORS2K	\$19.50/ea

BUY NOW

Jorvet Polansky Speculum



Vendor	Item#	Price
JORGENSEN	JORS2P	\$92.00/ea

BUY NOW

Franks Emasculator

JorVet

Vendor	Item#	Details	Price
JORGENSEN	JOR36FS	7.5" Stainless Steel	\$90.00/ea

White's Modified Emasculator

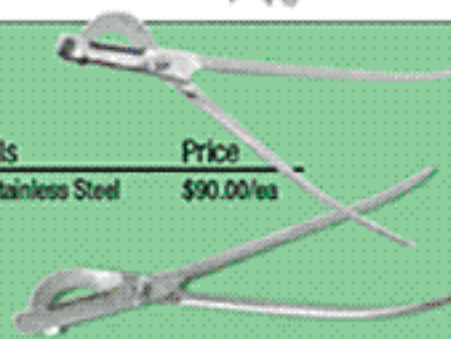

Item#	Details	Price
JOR36P	Stainless steel, 12"	\$116.00ea

BUY NOW

Standard Emasculator

Hausman Standard Emasculator.

Item#	Details	Price
JOR36P	Stainless steel, 12"	\$116.00ea

BUY NOW

Small Emasculator

Small Emasculator, Stainless steel, 7 1/2"

Item#	Details	Price
JOR36S	7 1/2"	\$81.00/ea

BUY NOW

Sands Castrator



Vendor	Item#	Details	Price
JORGENSEN	JOR36G	12" Stainless Steel	\$159.00/ea

BUY NOW

Reimer Emasculator Stainless Steel German

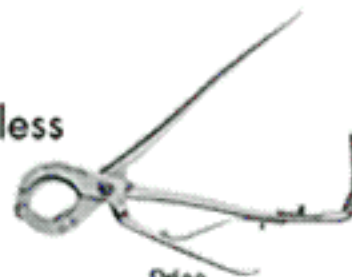

Vendor	Item#	Details	Price
JORGENSEN	JOR37	Stainless Steel 12 1/2" Long	\$430.00/ea

BUY NOW

Spay Packs

CANINE SPAY PACK **BUY NOW**

The Canine Spay Pack includes 18 stainless steel instruments. Available in three grades: Economy, Hi-Tech and Miltex.

- 1 Mayo Scissors 6 3/4" straight
- 1 #3 Scalpel/Blade Handle
- 1 Snook Hook 8"
- 2 Kelly Hemostat Forceps 5 1/2" curved
- 1 Metzenbaum Scissor, 5 1/2" curved
- 1 Tissue Forceps, 5 1/2", 1 x 2 teeth
- 4 Backhaus Towel Forceps 3 1/2"
- 1 Olsen-Hegar Needle Holder 6 1/2"
- 1 Adson-Brown Forceps 4 3/4" 7x7
- 1 Allis Forceps 6" 4x5
- 2 Halstead Mosquito Forceps, 5" curved
- 2 Rochester-Carmalt Forceps, 6.25" curved

Vendor	Item#	Details	Price
GERMAN WITH LIFETIME WARRANTY	CSPAY-GER	18 Instruments	\$291.99/ea
ECONOMY	CSPAY-ECON	18 Instruments	\$39.95/ea
INTEGRA/MILTEX	CSPAY-MIL	18 instruments	\$799.00/ea



HI-TECH
FINEST QUALITY
GERMAN SURGICAL
INSTRUMENTS
German
Instruments Only

FELINE SPAY PACK **BUY NOW**

The Feline Spay Pack includes 18 stainless steel instruments. Available in three grades: Economy, Hi-Tech and Miltex.

- 1 Mayo Scissors 6 3/4" straight
- 1 #3 Scalpel/Blade Handle
- 1 Snook Hook 8", Small End 4mm
- 2 Kelly Hemostat Forceps 5 1/2" curved
- 1 Metzenbaum Scissor, 5 1/2" curved
- 1 Tissue Forceps, 5 1/2", 1 x 2 teeth
- 4 Backhaus Towel Forceps 3 1/2"
- 1 Olsen-Hegar Needle Holder 5 1/2"
- 1 Adson-Brown Forceps 4 3/4" 7x7
- 1 Allis Forceps 6" 4x5
- 2 Halstead Mosquito Forceps, 5" curved
- 2 Rochester-Carmalt Forceps, 6.25" curved

Vendor	Item#	Details	Price
GERMAN WITH LIFETIME WARRANTY	FSPAY-GER	18 Instruments	\$291.99/ea
ECONOMY	FSPAY-ECON	18 Instruments	\$39.95/ea
INTEGRA/MILTEX	FSPAY-MIL	18 Instruments	\$799.00/ea



HI-TECH
FINEST QUALITY
GERMAN SURGICAL
INSTRUMENTS
German
Instruments Only

Jorvet Tenotome **BUY NOW**



Vendor	Item#	Price
JORGENSEN	JOR88A	Small, Blunt and Curved, 15 x 3mm blade. \$9.90/ea
	JOR88BC	Blunt and curved, 5cm x 1/2cm blade. \$24.00/ea
	JOR88BS	Blunt and Straight, 5cm x 1/2cm blade. \$24.00/ea
	JOR88SC	Sharp and Curved, 5cm x 1/2cm blade. \$24.00/ea

Jorvet Nano Paste Syringe **BUY NOW**

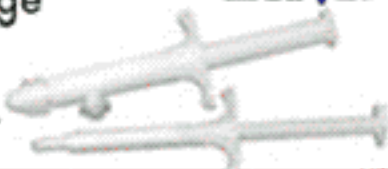

Vendor	Item#	Price
JORGENSEN	JOR338A	\$160.00/ea

Instrument ID Roll Tape **BUY NOW**

Vendor	Item#	Details	Price
MEDLINE	JOR832F	Fluorescent orange	\$24.50/roll
	JOR832G	Kelly Green	\$24.50/roll
	JOR832R	Red	\$24.50/roll
	JOR832B	Royal Blue	\$24.50/roll
	JOR832P	Purple	\$24.50/roll
	JOR832S	Set of 5 Colors	\$121.50/ea



Instrument Color Code ID Ring

Assorted Package of 100

Vendor	Item#	Price
JORGENSEN	JOR832X	\$18.90/ea



Instrument/Mayo Trays, Emesis Basins, Dressing Jars, Sponge Bowls, Thermometer/Forceps Jars & More

CHECKOUT OUR EQUIPMENT SECTION THIS CATALOG

Spay/Instrument Packs

Jorvet Spay/Neuter Surgery Pack

Complete surgery pack for routine spay and general surgery. Features a mix of German-made and/or economy instruments.

- Olsen Hegar Needle Holder. Tungsten carbide tip. German-made. 6 1/2" L (~16cm).
- Mayo Scissors. Straight. German-made. 5 1/2" L (~14cm).
- Instrument Tray. 10" x 6 3/4" x 2" (~25.4cm x 17cm x 5cm).
- Heavy-Duty Cloth Pack Wrap. 27" x 27" (~68.5cm x 68.5cm).
- Huck Towel. 17" x 33" (~43cm x 84cm).
- Brown Adson Forceps. German-made. 4 3/4" (~12cm).
- Scalpel Handle. #3 economy.
- Sponge Forceps. Economy. 8" (~20cm).
- Four Backhaus Towel Clamps. Economy. 5 1/2" (~14cm).
- Two Mosquito Forceps. Straight. Economy. 5" (~12.7cm).
- Two Kelly Forceps. Curved. Economy. 5 1/2" (~14cm).
- Snook Spay Hook. Economy. 8" (~20cm).
- Allis Tissue Forceps. Economy. 6" (~15cm).
- Spring Suture Needle Holder. German-made.
- Two Carmalt Forceps. CVD. Economy.

Vendor	Item#	Price
JORGENSEN	JOR432	\$210.00/ea

BUY NOW



Surgical Instrument Guards

Jorvet instrument guards are designed to protect valuable instrument tips from damage during sterilization and handling. Sharp and pointed tips can break through sterilization pouches and injure the surgeon. 50/pkg. Non-sterile, but can be autoclaved or gas sterilized. Medical-grade plastic (vented). Guards can also work as covers over exposed bone pins.

Vendor	Item#	Details	Price
JORGENSEN	JOR926S	Assorted Set	\$18.45/ea
	JOR926J	Black, 1/8" x 1" x 1" (3.2mm x 25mm x 25mm)	\$14.70/ea
	JOR926B	Blue, 5/64" x 3/4" (2.0mm x 19mm)	\$15.30/ea
	JOR926H	Brown, 5/64" x 5/8" x 1" (2.0mm x 16mm x 25mm)	\$15.30/ea
	JOR926C	Green, 7/64" x 3/4" (2.8mm x 19mm)	\$15.30/ea
	JOR926F	Maroon, 13/32" x 3/4" (10.3mm x 19mm)	\$14.70/ea
	JOR926G	Orange, 1/16" x 3/8" x 1" (1.6mm x 9.5mm x 25mm)	\$14.70/ea
	JOR926D	Red, 1/8" x 1" (3.2mm x 25mm)	\$15.75/ea
	JOR926A	White, 1/16" x 3/4" (1.6mm x 19mm)	\$16.20/ea
	JOR926E	Yellow, 3/16" x 1" (4.8mm x 25mm)	\$14.70/ea



7 Instrument Pack

General Instrument Pack- Seven Non-Sterile Includes:

- | | |
|---------------------|----------------------------|
| 1 Iris Forceps | 1 Thumb Tissue Forcep |
| 1 Iris Scissor | 1 Utility Bandage Scissors |
| 1 Mosquito Forcep | 1 Webster Needle Holder |
| 1 O.R. Scissor, S/B | |

BUY NOW

Vendor	Item#	Details	Price
ECONOMY	GP7	7 Instruments	\$6.99/ea

10 Instrument Pack

BUY NOW

General Instrument Pack- Ten Non-Sterile Includes:

- | | |
|-----------------------------|----------------------------|
| 1 Adson Dressing Forceps | 1 Mosquito Forceps |
| 1 Baumgartner Needle Holder | 2 Thumb Dressing Forceps |
| 1 Derf Needle Holder | 1 Utility Bandage Scissors |
| 1 Iris Forceps | 1 Webster Needle Holder |
| 1 Iris Scissors | |

Vendor	Item#	Details	Price
ECONOMY	GP10	10 Instruments	\$9.99/ea

14 Instrument Pack

BUY NOW

The Economy Instrument Pack includes:

- | | |
|-----------------------------|----------------------------|
| 1 Adson Dressing Forceps | 1 Mosquito Forceps |
| 1 Allis Tissue Forceps | 1 OR Scissors |
| 1 Backhaus Towel Clamp | 1 Rochester-Pean Forceps |
| 1 Baumgartner Needle Holder | 1 Thumb Dressing Forceps |
| 1 Crile Forceps | 1 Utility Bandage Scissors |
| 1 Derf Needle Holder | 1 Webster Needle Holder |
| 1 Iris Forceps | |
| 1 Iris Scissors | |

Vendor	Item#	Details	Price
ECONOMY	PACK14	14 Instruments	\$13.99/ea

General Surgery Pack **BUY NOW**

The General Surgery Pack includes 19 stainless steel instruments. Available in three grades: Economy, Hi-Tech and Miltex.

- | | |
|--|---|
| • 1 Mayo Scissors 6 3/4" straight | • 4 Rochester-Carmalt Forceps 6 1/4" crv. |
| • 1 Metzenbaum Scissor 7" curved | • 4 Backhaus Towel Forceps 3 1/2" |
| • 1 #3 Scalpel/Blade Handle | • 1 Olsen-Hegar Needle Holder 6 1/2" |
| • 3 Halstead Mosquito Forceps 5" curved | • 1 Adson-Brown Forceps 4 3/4" 7x7 |
| • 2 Kelly Hemostat Forceps 5 1/2" curved | • 1 Snook Hook |

Vendor	Item#	Details	Price
ECONOMY	GPACK-ECON	19 Instruments	\$59.00/ea
GERMAN	GPACK-GER	19 Instruments	\$249.00/ea
INTEGRA/MILTEX	GPACK-MIL	19 Instruments	\$1,229.47/ea

German Instrument Packs & Miscellaneous

German Knee Pack

General Knee Pack includes:

- 1 Hohmann Retractor
- 2 Mini-Hohmann Retractors
- 1 Gelpi Retractor 3 1/2"
- 1 Gelpi Retractor 5 1/2"
- 1 Senn Retractor, Sharp
- 1 Senn Retractor, Blunt
- 1 Rochester-Oschner Forcep

BUY NOW

Vendor	Item#	Details	Price
GERMAN	KNEE-GER	8 Instruments	\$279.99/ea

German Osteotome Pack

General Osteotome Pack includes:

- 1 Mead Mallet 5" x 15mm
- 5 Lambotte Osteotomes:
 - 7" x 4mm
 - 5" x 4mm 7" x 10mm
 - 5" x 10mm

BUY NOW

Vendor	Item#	Details	Price
GERMAN	OST-GER	6 Instruments	\$199.99/ea

German Eye Pack

German Eye Pack includes:

- Dorf Needle Holder
- Stevens Tenotomy Scissors
- Barraguer Eye Retractor
- Bishop-Harmon Forcep
- Sterilization Tray

BUY NOW

Vendor	Item#	Details	Price
GERMAN	EYE-GER	5 Instruments	\$119.99/ea

German Orthopedic Pack

The German orthopedic pack comes complete with 14 German Hi-Tech stainless steel instruments.

- 1 Mead Mallet
- 1 Lambotte Osteotome, 5" x 10mm
- 1 Gigli Saw Handle (2 per set)
- 1 Gigli Wire Saw, 12"
- 1 Gigli Wire Saw, 20"
- 1 Olsen-Hegar Needle Holder 5 1/2"
- 1 Senn Retractor, Sharp
- 1 Senn Retractor, Blunt
- 1 Retractor
- 1 Baby Kern Bone Folding Forcep
- 1 Kern Bone Holding Forcep
- 1 Roger Wire Cutting Scissors
- 1 Wire Twister/Shear Cutter
- 1 IM Pin Bag

BUY NOW

Vendor	Item#	Details	Price
GERMAN	ORTH-GER	14 Instruments	\$449.00/ea



Vulva Suture Pin

BUY NOW

Vulva Suture Pin Insertion Needle.

Vendor	Item#	Details	Price
JORGENSEN	JOR24V	Insertion Needle	\$9.00/ea
	JOR24V	Pin, 70mm	\$3.75/ea
	JOR24VS	Spacer, Pair	\$6.00/pr

Finger Ring Cutter

BUY NOW

Vendor	Item#	Details	Price
JORGENSEN	JOR887	6 1/2" (16cm).	\$67.00/ea
	JOR887D1	Replacement Blade for JOR887	\$20.00/ea

Ameriod Constrictors

BUY NOW

For the surgical treatment of porto caval or hepatic shunts. This special designed product is used to encircle a blood vessel. A special material (hygroscopic compressed casein) inside the donut shaped constrictor imbibes fluid over time. It slowly occludes the blood vessel. A small key is used to lock it in place after it is slipped over the blood vessel. Sizing: about a 50% reduction in the blood vessel diameter should be achieved upon initial surgical placement for the best results. Sterile.

Vendor	Item#	Details	Price
JORGENSEN	JOR659	5mm	\$104.00/ea
	JOR659A	3.5mm	\$95.00/ea

Catheter Tray

BUY NOW

Vendor	Item#	Details	Price
INTEGRA/MILTEX	MIL3-943	17 1/4 X 4 1/2 X 2 MILTEX	\$80.41/ea

Curved Boning Knife

BUY NOW

Vendor	Item#	Details	Price
JORGENSEN	JOR513	6"	\$31.50/ea

Necropsy Knives

These high-quality molybdenum-hardened stainless steel bladed knives come with a yellow nylon no-slip grip handle. German-made.

Vendor	Item#	Details	Price
JORGENSEN	JOR515	Curved, 6"	\$42.00/ea
	JOR507A	German-Made, Narrow Blade, 5"	\$31.50/ea
	JOR507B	German-Made, Narrow Blade, 7"	\$32.90/ea
	JOR502A	Wide Blade, 5"	\$33.00/ea
	JOR502B	Wide Blade, 7"	\$36.00/ea

Spray Lube

BUY NOW

Vendor	Item#	Details	Price
INTEGRA/MILTEX	MIL3-700	8oz pre-mixed, non-silicone, anti-corrosive formula	\$157.06/btl

Diamond Sharpener

BUY NOW

Vendor	Item#	Details	Price
JORGENSEN	JOR902DM	Medium, Comes with leather case.	\$21.90/ea
	JOR902DS	Small, for easy carrying in a shirt pocket.	\$9.00/ea

Surgical and Exam Supplies



Gowns; Surgical, Fluid Resistant &

Sterile Surgeon Gown (A) **BUY NOW**

Made from SMS fabric, these sterile surgical gowns come individually packaged. Full back with wrap-around style and knit sleeves. Light blue. Comes with sterile towel.

OSGL	Large	\$3.29/ea	\$2.99/35+
OSGM	Medium	\$3.29/ea	\$2.99/35+
OSGXL	X-Large	\$3.29/ea	\$2.99/35+
OSGXXL	XX-Large	\$3.29/ea	\$2.99/35+

Premium Sterile Surgeon Gown (B) **BUY NOW**

Sterile surgeon gown comes individually wrapped with towel. These gowns are made of a non-woven material that helps provide a barrier to blood, body fluids and pathogens. They offer a high level of protection without compromising comfort. They are cut wider through the chest and sleeves for a roomier fit and feature a velcro-style neck closure that allows the neckline to easily adjust to a wide variety of people. In addition, the velcro-style closure helps prevent gapping in the front of the gown to further protect against fluids. The gowns are very low linting, minimizing the risk of introducing particles into the O.R.

AHSSGL	Large	\$3.49/ea	\$3.29/30+
AHSSGXL	X-Large	\$3.49/ea	\$3.29/30+
AHSSGXXL	XX-Large	\$3.69/ea	\$3.59/30+

Disposable Non-Sterile Surgeon Gown (C)

These gowns are made of a non-woven material that helps provide a barrier to blood, body fluids and pathogens. They offer a high level of protection without compromising comfort. They are cut wider through the chest and sleeves for a roomier fit and feature a velcro-style neck closure that allows the neckline to easily adjust to a wide variety of people. In addition, the velcro-style closure helps prevent gapping in the front of the gown to further protect against fluids. The gowns are very low linting, minimizing the risk of introducing particles into the O.R.

MVGNSL	Large	\$1.99/ea	BUY NOW
MVGNSXL	X-Large	\$1.99/ea	
MVGNSXXL	XX-Large	\$2.29/ea	

Cloth Reusable Surgeon Gown (D) **BUY NOW**

100% cotton surgeon gown with tunnel belt, unisex. Finest quality surgeon gowns have sturdy double-stitched seams. Full 50" to 56" from shoulder to hem. Raglan sleeves with stockinette cuffs.

AHSGS-C	Small, 100% Cotton	\$19.99/ea
AHSGM-C	Medium, 100% Cotton	\$19.99/ea
AHSGL-C	Large, 100% Cotton	\$19.99/ea
AHSGXL-C	X-Large, 100% Cotton	\$19.99/ea
AHSGXXL-C	XX-L, 100% Cotton	\$20.99/ea

Cloth Reusable Surgical Gown With Panel (E)

Critical-Coverage Gown. Surgical gown with chest and arm panel for extra protection.

AHSGL-P	Large	\$27.99/ea
AHSGXL-P	X-Large	\$27.99/ea

Jorvet Disposable Surgery Gown (F) **NEW**

Full back with wrap-around style and knit sleeves. Light-blue fabric. Non-sterile. Can be safely autoclaved and even washed.

JOR739B	Sontara Fabric Gown, Medium	\$5.40/ea
JOR739A	Sontara Fabric Gown, Large	\$6.60/ea
JOR739C	Sontara Fabric Gown, X-Large	\$5.40/ea
JOR739P	SMS Fabric Gown, Medium	\$4.50/ea
JOR739M	SMS Fabric Gown, Large	\$4.50/ea
JOR739N	SMS Fabric Gown, X-Large	\$4.50/ea

Jorvet Sterile Disposable Surgery Gown

Packed in a protective clear bag with a header, wrapped in standard CSR wrapper. Hand towel included. Regular procedure. Full back with wrap-around style. Knit fabric sleeves. Light blue. **Jorvet**

JOR738	Sterile, Large	\$9.90/ea
JOR738L	Sterile, X-Large	\$10.80/ea
JOR738XP	Extended Procedure, Large	\$11.10/ea
JOR738XPL	Extended Procedure, X-Large	\$11.40/ea



Surgical Gowns

Proxima

NEW



MADE WITH SUPREL[®]
MEDICAL FABRIC



Aurora Surgical Gown



Aurora Surgical Gown

BUY NOW

Aurora Gown, Non-Reinforced: Aurora gowns are made with Suprel medical fabric from DuPont. This innovative fabric is manufactured using a patented process (utilizing 18 patents) to create a fabric that's both highly protective and extremely comfortable. The fabric features an advanced composite technology that utilizes polyester (for strength) combined with polyethylene (for softness). Aurora gowns offer a high level of protection without compromising comfort. Featuring new fabric technology, Aurora raises the bar for single-use O.R. gowns. Aurora gowns have a smooth texture that glides easily without catching or grabbing, giving you incredible freedom of movement. Plus, the gown helps to quickly transfer heat away from your body, keeping you cool and comfortable. For a high level of protection, Aurora gowns are a great choice. The gown's high hydrostatic head offers superior barrier performance. They are cut wider through the chest and sleeves for a roomier fit and feature a velcro-style neck closure that allows the neckline to easily adjust to a wide variety of people. In addition, the velcro-style closure helps prevent gapping in the front of the gown to further protect against fluids. Aurora gowns are very low linting, minimizing the risk of introducing particles into the O.R. Aurora gowns meet the Standard for flammability of Clothing Textiles CPSC 16 CFR Part 1610.

DYNJP2701	Large, Sterile with Towel 30/case	\$143.92/cs
DYNJP2702	X-Large, Sterile with Towel 30/case	\$149.88/cs
DYNJP2703	XX-Large, Sterile with Towel 18/case	\$103.60/cs

Fluid Resistant Isolation Gowns

Made from Lightweight Fluid-Resistant 4-Ply SMS material. Gowns feature strong seams to withstand fluids. Gowns are generously sized for full coverage and flexibility and are constructed with waist and neck ties to ensure a secure fit.



BUY NOW

27236	50/Cs Regular	\$29.00/cs
27236XL	50/Cs X-Large	\$39.00/cs

Polyethylene Coated Gown

Polyethylene coated polypropylene gowns provide a high level of fluid protection. Waist and neck ties ensure that gowns remain securely in place to protect clothes.



BUY NOW

27114	50/Cs Regular	\$49.95/cs
27114XL	50/Cs X-Large	\$49.95/cs

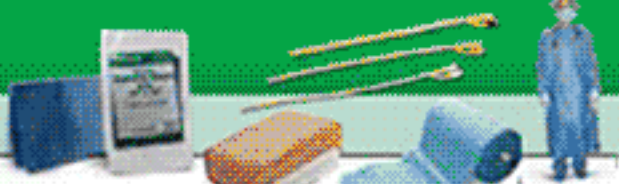

Proxima

NEW



Eclipse Surgical Gown



Eclipse Surgical Gown

BUY NOW

Eclipse Gown, Non-Reinforced: The first feature you will notice about the Eclipse gown is the way it feels. The soft, cloth-like texture says "comfort" as soon as you put it on. Those who spend much of their day in a surgical gown will appreciate the comfort of Eclipse. Eclipse Gowns are cut wider through the chest and sleeves for a roomier fit. The Eclipse gowns feature a velcro-style neck closure that allows the neckline to easily adjust to a wide variety of people. In addition, the velcro-style closure helps prevent gapping in the front of the gown to further help protect against fluids. Eclipse Gowns are made with breathable Softesse medical fabric from DuPont. For more than 25 years, DuPont Softesse medical fabric has been considered an industry standard for medical gowns and drapes. The fabric features advanced material technology that provides a splash resistant barrier that's breathable. It keeps you cool and comfortable while you work, helping you feel confident and in control.

DYNJP2005	Small, Sterile with towel 30/case	\$138.11/cs
DYNJP2001	Large, Sterile with towel 30/case	\$138.11/cs
DYNJP2003	XX-Large, Sterile with towel 18/case	\$136.29/cs
DYNJP2004	XXX-Large, Sterile with towel 18/case	\$136.29/cs

Isolation Gown JOR736

Fluid resistant, Yellow with full back. Knit fabric wrist cuffs. Universal size, full length with ties. Disposable. Universal Size.

JOR736 Yellow, 50/case \$63.50/cs

Isolation Gown w/Poly Coat JOR737

Poly-coated with thin film of protective plastic for fluid repellency. Blue with elastic wrist cuffs. Universal size, full length with ties. Disposable. Universal Size

JOR737 Blue, 50/case \$75.00/cs



BUY NOW

NEW

BUY NOW

Surgical Apparel

Surgical Masks

BUY NOW



MASK-C	Cone, 50/bx	\$8.00/bx	5+\$5.00/bx
MASK-E	Earloop, 50/bx	\$5.00/bx	5+\$4.00/bx
MASK-T	Tie on, 50/bx	\$5.00/pk	5+\$4.00/bx
MASK-T-FF	Tie-on Fog Free 50/bx	\$11.50/bx	

Goggles Fog Free (with Vents)

Fluid Protective Goggles. Soft, vinyl-frame goggles fit easily over prescription eyewear. Four air vents provide additional comfort. Available with specially-treated, anti-fog lenses for clear, unobstructed viewing. Goggles meet ANSI standards and help your facility meet OSHA requirements for hazardous liquids. Fog Free



NON24775 Fog free \$4.99/ea

BUY NOW

JorVet Eye Shields

Consists of reusable, lightweight frames, which thin, clear lenses snap onto.

- Removable protective film protects lenses before use.
- One size fits all.
- Frames come in an assortment of colors

JORS18 10 frames/25 shields \$37.50/ea
JORS18S Eye shields only refill kit, 25pk \$21.00/pk



BUY NOW

JorVet

JorVet Face Shield

Covers the entire face

- Consists of reusable, lightweight frames, which thin, clear lenses snap onto.
- One size fits all with an adjustable strap.
- Easily worn over glasses and masks.

JORS19 10 frames/10 shields \$63.00/ea
JORS19S Face shields only kit, 10pk \$32.00/pk



BUY NOW

JorVet

Safety Goggles

Molded of soft clean flexible vinyl that conforms to the face and nose. Four vents eliminate fogging. Clean acetate lenses. Can be worn over regular glasses.

JOR827 1/2"W adjustable head band. \$32.40/ea



BUY NOW

JorVet

Surgeon Cap

BUY NOW

- Durable
- Soft and comfortable
- Tie-on
- One size fits all
- Blue 100/bx

SURGCAP 100/bx \$9.99/bx

SURGCAP



Bouffant Cap

BUY NOW

Meets NFPA standards.

- Soft
- Breathable
- Elastic band opening
- Meets NFPA standards.
- No color choice

BOUFFANT 100/bx \$8.00/bx

BOUFFANT



Shoecover

BUY NOW

A soft, durable and lightweight shoe cover. Has a fuller cut and a more generous heel and instep. Designed to fit both large and small shoe sizes comfortably and snugly.

SHOECOVER-XL 200/bx X-Large \$23.90/bx

SHOECOVER 100/bx \$8.00/bx



Surgery Cap with Ties

JorVet

Surgeon's Cap with rear ties. Blue. 100/bx, 5 bx/case.

JOR735 100/bx, 5 boxes/case \$52.50/cs



JOR735

JOR732

Jorvet Surgery Mask

BUY NOW

Molded Face Mask with elastic strap and malleable aluminum nose piece, molded cup.

JOR732 Blue. 50/bx, 20 bx/case. \$115.00/cs

JOR734L

Surgery Cap, Bouffant Style

O.R. Nurse/Super Bouffant Style Headwear. Blue. 24".

JOR734 21", 100/bx, 5 bx/case. \$47.50/cs

JOR734L 24", 100/bx, 5 bx/case. \$53.50/cs

BUY NOW

JorVet



JOR733

Surgical Procedure Mask w/ Ear Loops

Procedure Mask with earloops. 2-ply.

JOR733 50/bx, 12 bx/case. \$62.50/cs

Surgery Mask, 3 ply w/ Ties

Surgery Mask with ties. Blue. 3-ply. 18cm x 20cm.

Bulk packaged in dispensing box.

JOR731 50/bx, 6 bx/case. \$38.50/cs

BUY NOW



Leg Drapes

BUY NOW

Made from the same high quality material as our surgical drapes. Available in two sizes.

EJLD24X30X9 GREEN, 24"x 30"x 9" \$10.78/ea

EJLD20X24X6 GREEN, 20"x 24"x 6" \$9.91/ea

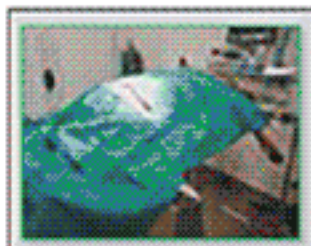

Drapes

Sterile Surgical Drapes

Sterile surgical drapes made of SMS non-woven material. Consists of two outer layers of SMS and a middle layer of polypropylene. Outer layers: Cloth-like, yet tough and abrasion-resistant spunbound polypropylene. Inner layer: Intricate web of microfibers filter out many water-based liquids and dry particles.

DR1826	18" X 26"	\$0.65/ea
DR4042	40" X 42"	\$1.62/ea
DR6080	60" X 80"	\$2.99/ea



Starting At
65¢/ea

BUY NOW



JorVet Veterinary Surgical Drape

BUY NOW

Quality surgical drapes of 50 percent cotton, 50 percent polyester, made of surgical grade textiles

- Fenestrated drapes feature a moisture proof barrier near the fenestration that repels body fluids so that they do not soak
- Through and draw up contaminants from beneath the drape into the surgical field
- Durable quality, may be safely washed and autoclaved frequently



JOR256A	20" x 28", 4" x 3/4" opening	\$10.05/ea
JOR256B	24" x 32", 2" x 1" opening	\$10.50/ea
JOR256C	30" x 36", 7" x 1 1/4" opening	\$11.85/ea
JOR256D	40" x 40", 9" x 1" opening	\$14.85/ea
JOR256E	40" x 40", 4" x 3/4" opening	\$14.85/ea
JOR256F	20" x 20", 2" circular opening, (for ophthalmic surgery)	\$10.50/ea
JOR256G	20" x 24", 6" x 9" opening, Leg Drape	\$11.10/ea
JOR256H	24" x 30", 9" x 12" Opening, Leg Drape	\$12.45/ea
JOR256J	20" x 24", 6" x 9" Opening, Non Fenestrated	\$7.65/ea

JorVet Impervious Drape

The base material is Sontara laminated with polyethylene film making it completely impervious. This drape has the highest tear strength of any drape fabric. It can be readily fenestrated at the time of surgery without the need for reinforcement. Fanfolded in easy opening header packer. Once you try this drape you will want it for all your extended procedures.

- Sterile individual wrap
- Covers entire patient

BUY NOW

JOR259A	40" x 42" 5 pk, sterile	\$23.00/pk
JOR259B	60" x 80" 5 pk, sterile	\$48.00/pk



Adhesive Drape w/Povidine

Impregnated with povidine (antimicrobial). There is no fenestration. Can also be used post op for wound protection. Light amber color. Sterile.

JOR259D	34" x 34", sterile	\$27.00/ea
JOR259E	24" x 14" sterile	\$10.50/ea
JOR259F	34" x 18" sterile	\$13.90/ea

BUY NOW



Fenestrated Drape

Cloth fenestrated drapes made from high quality surgical sheeting with built-in moisture barrier. Drapes are colorfast, washable, autoclavable and come in a choice of sizes.

2020-4	20" X 20"	4" X 3/4"	\$7.99/ea
2020-2R	20" x 20", W/2"	Circle Opening 5" barrier	\$7.99/ea
3030-2	30" X 30"	2" X 1"	\$8.99/ea
3030-4	30" X 30"	4" X 3/4"	\$9.99/ea
3030-7	30" X 30"	7" X 1.25"	\$10.99/ea
4040-4	40" X 40"	4" X 3/4"	\$11.99/ea
4040-7	40" X 40"	7" X 1.25"	\$11.99/ea
4040-10	40" X 40"	10" X 1.25"	\$11.99/ea

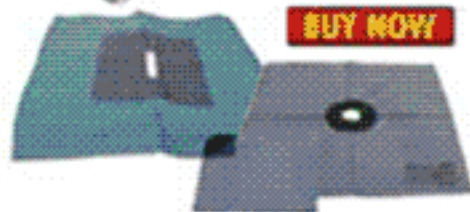

BUY NOW

Disposable Surgical Drape Sontara

BUY NOW

Sontara Disposable Surgical Drape. The original Jorvet drape with the blue, rich cloth-like feel of Sontara fabric packaged in a fan-folded box, 36" W x 100 yds in Length.

MVD 36" X 100 Yards \$75.00/bx



Jorvet Sontara Drape

BUY NOW

Sontara Drape is a popular DuPont product that has a soft cloth like feel. It is fluid repellent, but fluids will strike through with extended exposure. It can be readily autoclaved. Sontara can also be coated with a clear poly film to make it impervious. However the impervious material cannot be autoclaved and is provided sterile

JOR1060A	44" x 55", non-sterile	\$4.50/ea
JOR1060B	44" x 55", sterile, tyvek pouch	\$5.10/ea
JOR1060C	55" x 77", non-sterile	\$5.60/ea
JOR1060D	55" x 77", sterile, tyvek pouch	\$6.50/ea

Jorvet Towel Drape Plain ACT Material

JOR1065A	22" x 30" non-sterile, 4pk	\$5.20/pk
JOR1065B	22" x 30" sterile, 4pk, tyvek pouch	\$5.50/pk
JOR1065C	36" x 36" non-sterile, 4pk	\$7.20/pk
JOR1065D	36" x 36" sterile, 4pk, tyvek pouch	\$7.80/pk

Towel Drape Sontara

BUY NOW

BUY NOW

JOR1064A	22" x 30" non-sterile, 4pk	\$5.30/pk
JOR1064B	22" x 30" sterile, 4pk, tyvek pouch	\$5.95/pk
JOR1064C	36" x 36" non-sterile, 4pk	\$7.60/pk
JOR1064D	36" x 36" sterile, 4pk, tyvek pouch	\$8.10/pk

Coated Sontara

BUY NOW

JOR1061C	77" x 104", sterile, tyvek pouch	\$10.30/ea
----------	----------------------------------	------------

Surgical Pack Wrapper

Double-layered reusable wrappers.

BUY NOW

JOR257A	18" x 18"	\$7.95/ea
JOR257B	27" x 27"	\$10.20/ea
JOR257C	10" x 12"	\$5.10/ea
JOR257E	24" x 24"	\$9.75/ea
JOR257F	30" x 30"	\$11.25/ea



Surgical and Exam Supplies

Drapes & OR Towels

Disposable Surgical Drape SMS

This drape is made of SMS non-woven material. Consists of two blue outer layers of SMS and a middle layer of polypropylene. Fabric is low lint, helping to reduce wound contamination. Can be used as a drape, as fenestrated material or as a sterilization wrap. Autoclavable.

SMS40	40" x 100 Yards	\$52.00/roll
SMS60	60" x 65 Yards	\$52.00/roll

BUY NOW

Drape Dispenser

Dispenser also available, for full roll quantities*. Can be desk or wall mounted. *Note: For dispenser to be utilized, you must order the entire roll. Only rolls are shipped with the cores necessary for dispenser use.

H29	24" Each	\$21.95/ea
-----	----------	------------

Disposable Drape Jorvet

The original Jorvet drape with the blue, rich cloth-like feel of Sontara fabric packaged in a fan-folded box. 38"W x 100 yds in a blue and red box. Variance may be 36" to 40".

JOR258	38" x 100 yds.	\$75.00/ea
--------	----------------	------------

BUY NOW

Oversize Pre-cut Sontara Drape

Large oversized drape that is great for equine or large animal use. Folded to open first in the long dimension.

JOR2580	77" wide x 104" long. Sterile.	\$10.70/bx
---------	--------------------------------	------------

Extra-Wide Sontara Drape Jorvet

On dispensing roll. 60" x 100 yds. 22lbs.

JOR258W	60" x 100 yds. 22lbs.	\$108.00/ea
---------	-----------------------	-------------

BUY NOW

ACT Drape Jorvet

DuPont's newer material (Advanced Composite Technology) is gaining popularity for drapes and gowns. It has an embossed pattern and is comparable to SMS material. The plain material can be autoclaved but the impervious drape must be provided in sterilized pouches.

JOR1062A	44" x 55", non-sterile	\$3.80/ea
JOR1062B	44" x 55", sterile, tyvek pouch	\$4.20/ea
JOR1062C	55" x 77", non-sterile	\$4.70/ea
JOR1062D	55" x 77", sterile, tyvek pouch	\$4.90/ea
JOR1062E	77" x 104", non-sterile	\$7.00/ea
JOR1062F	77" x 104", sterile, tyvek pouch	\$7.90/ea

Coated ACT Drape Jorvet

JOR1063A	40" x 42", sterile, tyvek pouch	\$4.10/ea
JOR1063B	60" x 80", sterile, tyvek pouch	\$6.70/ea
JOR1063C	77" x 104", sterile, tyvek pouch	\$9.25/ea

BUY NOW

Surgery Towel Jorvet

Huck-style. General purpose surgery towels. 100 percent cotton. Highly absorbent. Light blue.

JOR257D	17" x 33", 1 dozen	\$39.00/dz
---------	--------------------	------------

BUY NOW

Combine Roll

Combine rolls, or composite padding, is a post-operative dressing used when excessive drainage from wounds demands more absorbency. The absorbent cotton, with a center layer of cellulose, has an exterior wrapping of soft non-woven fabric. Non-Sterile 20 yards in length.

3001	8" x 20 Yards	\$17.99/ea
3002	12" x 20 Yards	\$29.99/ea

BUY NOW

Sterile Surgical Drape

Sterile 3 ply Surgical Drapes are excellent for use during minor surgical procedures. Two layers of absorbent tissue with a polyethylene lining in between help eliminate risk of bacterial migration and moisture strike through. Available in both plain for general use, and fenestrated to allow access to operative site while protecting the surrounding area. Sterile, latex free.

20-001	18" x 26", 50/bx	\$12.99/bx
20-002	18" x 26", 3ply, 50/bx Fenestrated 2.75" dia	\$14.99/bx

BUY NOW

Jorvet Adhesive Surgical Drape w/Povidine

The majority of human surgeries use clear adhesive drape over the incision site. The rest of the patient is draped with standard non-woven disposable drape material. The clear adhesive drape offers several advantages:

1. Transparency—the film is ultra thin and highly transparent, which gives clear observation to the surgical field for locating anatomical landmarks.
2. Antibacterial—impregnated with povidine iodine giving the drape a slight orange tint. Very effective against most skin pathogens.
3. Fluid and pathogen resistance—sterile barrier prevents fluids or pathogens right up to the edge of the incision.
4. Permeable—allows the skin to breathe and vapor to pass.
5. High elasticity—follows natural contours for reliable gap-free adherence.
6. Low sensitivity—no irritation to skin or wound
7. Moderate viscosity—no injury to skin when removing the dressing.

Range of sizes, packaged sterile in sealed pouch

JOR1086A	6" x 8" Sterile, 20/bx	\$15.90/ea
JOR1086B	8" x 12", Sterile, 30/bx	\$26.40/ea

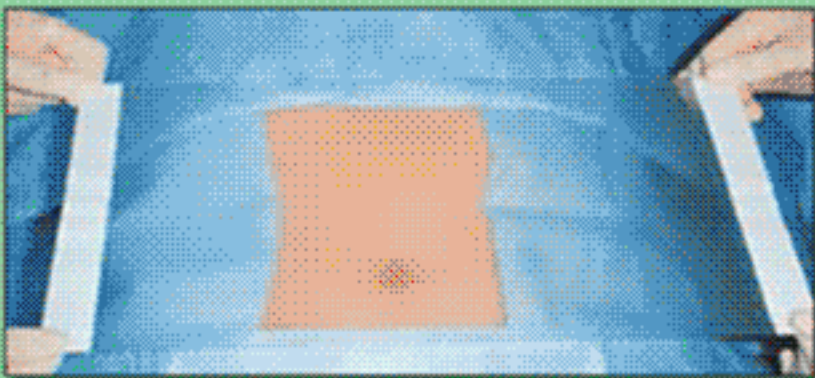

New Operating Towels

These new blue towels are made of 100% cotton. They measure 16" x 26" and are reusable. They can be autoclaved. These are top quality towels that will last a long time.

as low as
10+\$5.99/ea

AHSORT-B12	Cotton, 1 Dozen	\$8.99/dz
------------	-----------------	-----------

Price Breaks

2+\$7.99/ea	3+\$6.99/ea	10+\$5.99/ea
-------------	-------------	--------------

New Operating Towels

AHSORT-B12	Cotton, 1 Dozen	\$8.99/dz
------------	-----------------	-----------

Surgical and Exam Supplies

Iodine Solution/Scrub, Alcohol & Instrument Wraps

Povidone Iodine Solution

Prep solutions contain 10% weight by volume. Effective for skin and mucous membrane preparation prior to surgical prescrub. Solutions are antimicrobial solutions with surfactants, and contain 7.5% weight by volume Povidone Iodine, USP solution equivalent to 0.75% available iodine.

PVPSOL-G	1 Gallon	\$29.99/ea	BUY NOW
PVPSOL-P	16oz	\$4.29/ea	



Povidone Iodine Scrub Solution

Generous foaming action helps loosen foreign matter on skin. Rinses easily, leaving no residue. Emollient formulation is soft and non-drying to the skin.

PVPSOL-G	1 Gallon	\$29.99/ea	BUY NOW
PVPSOL-P	16oz	\$4.29/ea	



Facial Tissue

BUY NOW

A silicone tubular drain that may be trimmed, peeled away, or used as a whole piece for surgical wound drainage. The drain can be split along its length or trimmed to suit individual requirements. Autoclavable. 40cm L drain of 12-3mm dia. catheters.

46580 \$0.69



Alcohol Dispenser

BUY NOW

This handy pump bottle dispenses alcohol by pressing down on the top lid. Great for use in the exam room for alcohol wipes, pre-injection in vaccinations. 8 oz. amber polypropylene bottle.

JOR614 8 oz \$12.00/ea

NEW



Isopropyl Alcohol

BUY NOW

Cleans minor cuts, scrapes and burns while it reduces the risk of infection. Can be used in small amounts on affected areas one to three times daily. Once alcohol dries, wounds may be covered with sterile bandages. 70% U.S.P. Isopropyl alcohol by volume.

ALC-P 16 Oz, 70% \$1.59/ea



Hydrogen Peroxide

BUY NOW

3% U.S.P. hydrogen peroxide is used as a first aid antiseptic and cleaning agent. It can also be used to clean minor cuts, abrasions, and burns.

HYD-P 16oz \$0.99/ea



CSR Wrap

BUY NOW

Our disposable autoclavable wrappers are superior to muslin and are virtually memory free. The natural construction of these disposable wrappers enables the user to wrap continuously without fear of skin sensitization. These products breathe easily and are also highly liquid repellent. Can be used as surgical.

1412	12" x 12", 1000/cs	\$50.00/cs
1415	15" X 15", 1000/cs	\$65.00/cs
1418	18" X 18", 1000/cs	\$92.40/cs
1420	20" X 20", 1000/cs	\$109.83/cs
1424	24" X 24", 500/cs	\$90.00/cs
1430	30" X 30", 300/cs	\$72.06/cs
1436	36" X 36", 300/cs	\$98.73/cs
1440	40" X 40", 250/cs	\$120.00/cs
1445	45" X 45", 250/cs	\$140.00/cs
1448	48" X 48", 250/cs	\$173.00/cs
1454	54" X 54", 100/cs	\$80.00/cs



Cloth Instrument Wrap

BUY NOW

High quality, 2-Ply, safety-surged instrument wraps. Made of durable, colorfast, washable surgical sheeting. No color choice.

W1212	12" x 12"	\$2.25/ea
W1818	18" x 18"	\$2.79/ea
W2424	24" x 24"	\$3.99/ea
W3030	30" x 30"	\$4.99/ea
W3636	36" x 36"	\$6.99/ea



Alcohol Prep Pads

BUY NOW

Before injections, alcohol prep pads are used as a topical antiseptic, anti-infective. The soft, absorbent, non-woven pads are saturated with 70% isopropyl alcohol, USP.

APREP	70%, 200/bx	\$1.99/bx
APREP-L	70%, 100/bx	\$1.99/bx



Closed Block Scrub Brush

BUY NOW

Medium-textured nylon scrub brush with tapered tufts anchored by nickel-silver pins. Closed block, without nail cleaner on back.

ANB1000 1ea \$2.99/ea

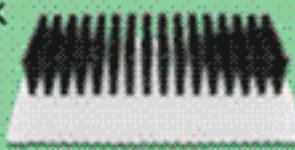

Povidone Iodine Prep Pads

BUY NOW

Used to prep skin with antiseptic bactericidal that does not irritate or sting. Saturated with Povidone/Iodine Solution. 100 per box. 1-1/4" X 1-1/2" Folded

PVP-PAD 100/bx \$4.99/bx



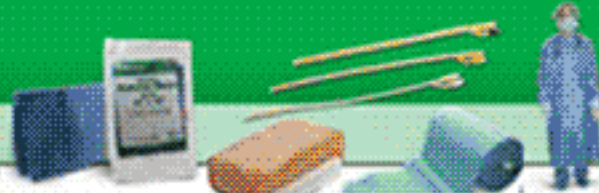

Scrub Brush, Drains & Positioners

Sterile Surgical Scrub Brush

Features: **BUY NOW**

- Soft outer bristles clean thoroughly without skin irritation.
- Inner bristles are shorter and contoured for effective deep cleaning of fingers, nails and cuticles.
- Brush flexes for easier scrubbing between and around fingers.
- Convenient peel-open package.

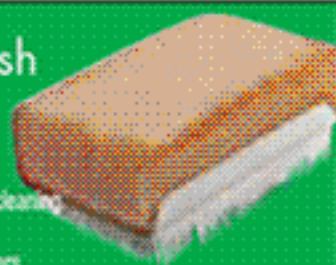

BR105	W/PVP IODINE	\$1.29/ea	\$1.19/30+
BR115	W/CHG HIBICLENS	\$1.29/ea	\$1.19/30+
BR120	W/PCMX SOLUTION	\$1.29/ea	\$1.19/30+
BR125	Dry Sterile	\$0.90/ea	\$0.89/30+

Surgical Scrub Applicator

Small, yellow sponge with plastic handle commonly used in human hospitals as an applicator for surgical scrub solutions such as Betadine.



JOR465 Sponge 2" x 2" x 1" thick, 8 3/4" L, 5/pkg. \$6.00/pk **BUY NOW**

Penrose Drain

BUY NOW

Penrose drains are ideal for fast and proper drainage of secretions. Soft, latex rubber minimizes wound irritation and trauma. Wide range of sizes for varied needs. X-ray opaque for easy placement verification. Single use. Sterile.

PD18X1/4	18" x 1/4"	\$0.75/ea	\$0.59/25+
PD18X3/8	18" x 3/8"	\$0.75/ea	\$0.59/25+
PD18X1/2	18" x 1/2"	\$0.75/ea	\$0.59/25+
PD18X5/8	18" x 5/8"	\$0.75/ea	\$0.59/25+
PD18X3/4	18" x 3/4"	\$0.75/ea	\$0.59/25+
PD18X7/8	18" x 7/8"	\$0.75/ea	\$0.59/25+
PD18X1	18" x 1"	\$0.75/ea	\$0.59/25+

Penrose Tubing

BUY NOW

Simple but effective pure latex drain for a variety of clinic uses. Sterile. 18" L. 50 individual peel pkgs/case.

JOR590A	3/8" (10mm)	\$35.00/ea
JOR590B	1/2" (15mm)	\$35.00/ea



Surgical Tie-Downs

BUY NOW

Wide-braided 3.8" polypropylene. Distributes tension over wide area. Royal blue color loop on one end. 4/bag

JOR1710 4/bg \$5.10/bg

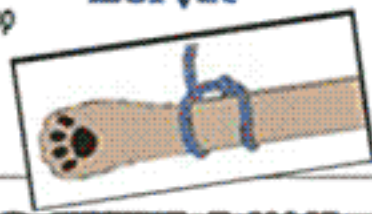

Thoracic Positioner

BUY NOW

Made from tough, lightweight plastic, these thoracic positioners are warmer than stainless steel, very easy to clean and are transparent to light and x-ray

EJTP-S	Small 8" X 7" Each	\$20.09/ea
EJTP-M	Medium 10" X 8" Each	\$24.00/ea
EJTP-L	Large 14" X 9" Each	\$30.01/ea
EJTP-A	Set of 3; Small, Medium, Large	\$69.69/ea

TOP SELLER



Jorvet Lexan Thoracic Positioner

Lightweight and easy to clean. V-shaped trough. Slightly elevated to help drain fluids away from patient. Radiolucent

JOR279A	Small	\$30.00/ea
JOR279B	Medium	\$34.50/ea
JOR279C	Large	\$45.00/ea
JOR279S	Set of 3	\$105.00/ea



BUY NOW

Multi Arm Positioner

Jorvet

A great positioner or holder for surgery (i.e. arthroscopy) or radiology. Velcro straps securely hold limbs of patients ranging from cats to giant dog breeds.

- Moves in three joints or planes allowing positioning at any angle
- Mounting clamp fixes the device to any surgery or X-ray table
- A single lever locks all three joints rigid
- Additional use — holding endoscopes while performing biopsies, or grasping tissues

BUY NOW

JOR930	Single Limb	\$339.00/ea
JOR930A	Double limb bracket	\$222.00/ea



Stifle Positioner

Developed in association with Professor Kurt Schulz of UC Davis Veterinary School, this attachment is especially designed for maintaining the stifle joint in proper position for an arthroscopy procedure. It is positioned above the stifle on the distal third of femur. Adjustment of positioner under draping is very simple.

JOR930X Attachment only \$320.00/ea



BUY NOW

Tomcat Positioner

BUY NOW

Great positioner for restraining male cats and exposure of perineal area. Good for working with urethral obstructions and for neutering. No tie-downs or other assistance necessary. Lightweight and adjustable.

JOR279T \$39.00/ea



Surgical and Exam Supplies

Catheters

Foley Catheter

BUY NOW

An innovative manufacturing process provides the maximum amount of silicone coating available. Latex catheter is coated internally and externally in 100% silicone to resist encrustation and bacterial colonization. 2-way Foley. Sterile.

FC3X6	3cc x 6Fr	\$3.29/ea	FC5X20	5cc x 20Fr	\$1.50/ea	FC30X16	30cc x 16Fr	\$1.50/ea
FC3X8	3cc x 8Fr	\$3.29/ea	FC5X22	5cc x 22Fr	\$1.50/ea	FC30X18	30cc x 18Fr	\$1.50/ea
FC3X10	3cc x 10Fr	\$3.29/ea	FC5X24	5cc x 24Fr	\$1.50/ea	FC30X20	30cc x 20Fr	\$1.50/ea
FC5X12	5cc x 12Fr	\$1.50/ea	FC5X26	5cc x 26Fr	\$1.50/ea	FC30X22	30cc x 22Fr	\$1.50/ea
FC5X14	5cc x 14Fr	\$1.50/ea	FC5X28	5cc x 28Fr	\$1.50/ea	FC30X24	30cc x 24Fr	\$1.50/ea
FC5X16	5cc x 16Fr	\$1.50/ea	FC5X30	5cc x 30Fr	\$1.50/ea	FC30X26	30cc x 26Fr	\$1.50/ea
FC5X18	5cc x 18Fr	\$1.50/ea	FC30X12	30cc x 12Fr	\$1.50/ea	FC30X28	30cc x 28Fr	\$1.50/ea
			FC30X14	30cc x 14Fr	\$1.50/ea	FC30X30	30cc x 30Fr	\$1.50/ea

**TOP
SELLER**

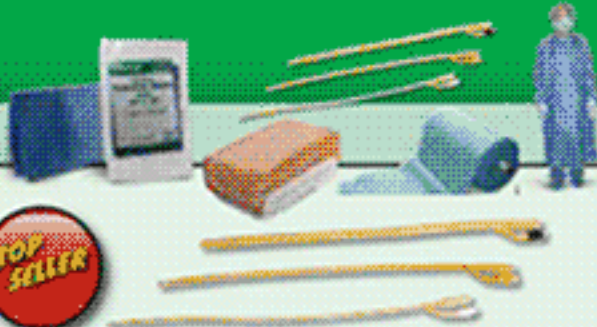

Plastic Urethral Catheter

BUY NOW

Clear Vinyl Intermittent Self Catheters: Suitable for male or female catheterization. Smooth tip, comfort eyes and funnel end. Radiopaque. Male/Universal Clear Vinyl Intermittent Self Catheter.

DYND10712	6Fr, 10" Length.	\$0.50/ea
DYND10713	8Fr, 10" Length.	\$0.50/ea
DYND10714	10Fr, 10" Length.	\$0.50/ea
DYND10722	12Fr, 16" Length.	\$0.50/ea
DYND10703	14Fr, 6" Length.	\$0.50/ea
DYND10723	14Fr, 16" Length.	\$0.50/ea



Urethral Catheter

BUY NOW

Red Rubber Latex Urethral Catheters: Suitable for male or female catheterization. Smooth tip, two oval eyes and funnel end. 16" length and radiopaque.

DYND13508	8fr, Sterile	\$8.95/cs
DYND13510	10fr, Sterile	\$8.95/cs
DYND13512	12fr, Sterile	\$8.95/cs
DYND13514	14fr, Sterile	\$8.95/cs
DYND13516	16fr, Sterile	\$8.95/cs
DYND13518	18fr, Sterile	\$8.95/cs
DYND13520	20fr, Sterile	\$8.95/cs



Malecot Catheter

BUY NOW

Jorvet

Amber latex rubber; 4-wing tip that collapses. Funnel end. Sterile.

JOR445A 10 Fr \$25.50/ea



Tom Cat Catheter (Kendall)

BUY NOW

Semi-Rigid polypropylene urinary catheter comes with adaptor to easily secure in place.

703005 3.5 french, 5.5", closed end \$1.25/ea
703021 3.5 french, 5.5", open end \$1.25/ea

Canine Urinary Catheter

Jorvet

Constructed of a flexible transparent grade of nylon, producing firmness without rigidity. Female luer fitting. Closed end with lateral eye. Sterile.

JOR154XS 4fr x 50cm (20") \$6.30/ea
JOR154S 6fr x 50cm (20") \$6.90/ea
JOR154M 8fr x 50cm (20") \$6.90/ea
JOR154L 10fr x 50cm (20") \$7.80/ea



BUY NOW

Jorvet Catheter Plug

Designed to temporarily plug feeding tubes and catheters (i.e. Foley), when not in use. Thumb grip.

JOR598 Sterile, 5/pk. \$9.00/pk



Feline Urethral

BUY NOW

These feline urethral catheters are stainless steel and have blunt olive tips to prevent damage. Available in packs of two or sets of six.

EJMOTF22X.5	22g x 5" 1.4mm tip	\$16.25/ea
EJMOTF22X1	22g x 1" 1.4mm tip	\$16.25/ea
EJMOTF22X1.5	22g x 1.5" 1.4mm tip	\$16.25/ea
EJMOTF6	Feline Set Of 6	\$48.09/ea

**TOP
SELLER**

Tom Cat Catheter (Jorgensen)

This silicon catheter with luer fitting and suture holes is more bio-friendly. Includes wire guide stylet.

JOR153X Closed End 5" \$25.20/ea
JOR153Y Open End 5" \$25.20/ea

BUY NOW

Canine Catheter

Canine Female Catheter. Female luer fitting. Metal cleaning rod included. 18cm x 2.5mm.

JOR90C 18 cm. x 2.5 mm. \$21.00/ea

BUY NOW

Bitch Catheter

Bitch Urinary Catheter. Stainless steel. 10g heart-shaped finger rest. 101/2"L.

JOR90H 10 1/2" \$12.60/ea

BUY NOW



Catheters & Skin Markers

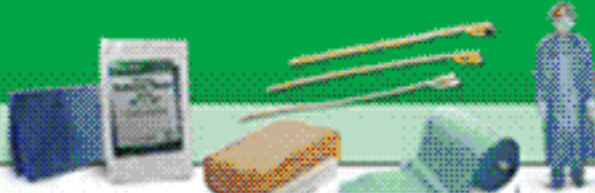

Jackson Cat Catheter

BUY NOW

This specially designed feline catheter is for aid in treatment of FLUTD. It is a modification of the standard feline catheter but with a shorter length (11cm) and metal stylette. There are convenient holes in the luer mount for suture attachment. Sterile.

JOR153JA	3 French	\$8.40/ea
JOR153JB	4 French	\$8.40/ea
JOR153JAS	3 French, PORTEX	\$18.00/ea
JOR153JBS	4 French, PORTEX	\$18.00/ea



Foley Latex Catheter

BUY NOW

Equine Use. Excellent for uterine flushes. Sterile.



JOR447Q	26fr x 16" with 30cc balloon	\$9.75/ea
JOR447R	30fr x 16" with 30cc balloon	\$10.05/ea

Silicone-coated amber latex Foley catheter. 2-way with opposed lateral eyes at tip. Sterile.

JOR447S	6fr x 12" with 3cc balloon	\$12.15/ea
---------	----------------------------	------------

Adapter Male Luer/Male Catheter

Male Luer Lock Connector with male is barbed on a Christmas tree connector. Also fits in a suction hose.



JOR599	\$7.65/pk
--------	-----------

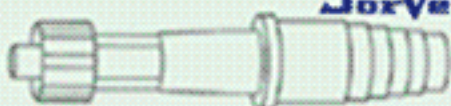

BUY NOW

Female Luer to Male Catheter



JOR597	5 pk	\$16.50/pk
--------	------	------------

BUY NOW

Chambers Catheter

BUY NOW

Stainless steel with slightly curved tip. Finger rest, luer slip adaptor. The preferred instrument for flushing the guttural pouch. Also can be used for uterine flushes.

JOR27G	8g. 22"L	\$37.50/ea
--------	----------	------------



Surgical Skin Marker w/Ruler



These surgical skin markers are routinely used in human cosmetic surgery. The special ink allows for ready identification of anatomical landmarks to be done before surgery. The markers come sterile and each have their own flexible metric and inches ruler. Works on all ranges of pigmented skin. 2/pk each in an individual sterile package.

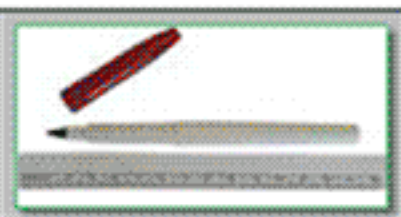

BUY NOW

JOR435	Sterile 2pk	\$4.95/pk
--------	-------------	-----------

Pezzar Catheter



Great for PEG feeding tubes. Mushroom tip assists in catheter retention, with 2cm and 4cm markings from tip's base to aid in proper catheter placement.

- Mushroom tip
- Soft silicone. 36 cm

BUY NOW



JOR446M	16FR O.D. x 3.2MM I.D. x 5.3MM O.D.	\$27.00/ea
JOR446P	20fr O.D. 4.0mm I.D. 6.7mm O.D.	\$33.60/ea
JOR446R	22fr O.D. 4.0mm I.D. 7.3mm O.D. X-Large 25mm dia. tip.	\$30.00/ea

Silicone Acute Peritoneal Dialysis Catheter



In an emergency situation where peritoneal dialysis needs to be performed, this catheter is invaluable. The distal tip has a number of fenestrations for widespread drainage, plus is covered by a loose fitting dacron mesh that helps avoid obstructing these fenestrations. Sterile.

JOR988	15fr (5mm) x 80cm. Distal portion is 16mm O.D.	\$78.25
--------	--	---------

BUY NOW



Broncho Alveolar Lavage Catheter

This catheter is designed to perform lavage on upper rear section of the equine lung. It's main use is for the detection of "Bleeders" or exercise induced pulmonary hemorrhage. The BAL catheter can also be used for cytology or culturing the airways. The catheter is inserted nasally. The cuff inflated when in position. A 3-way stop cock is used for administration and aspiration of fluid. The stiffness of the catheter makes for ease of passage.

JOR639	30fr (10mm) x 240cm L, 10cc cuff	\$48.00/ea
--------	----------------------------------	------------



BUY NOW



Jorvet Suction Catheter



These catheters are used when regular suction handles are too large. One end will fit on a standard suction hose. A vent on the catheter allows for on/off suction control. 5 per package.

JOR695	6Fr 5/Pk	\$11.25/pk	JOR695C	14Fr 5/Pk	\$11.25/pk
JOR695A	8Fr 5/Pk	\$11.25/pk	JOR695D	18Fr 5/Pk	\$10.65/pk
JOR695B	10Fr 5/Pk	\$11.25/pk			

BUY NOW

BUY NOW



Shop 24/7 for your vet med supplies @ our Online Store

Have a question about your order?
Our friendly customer service representatives are here to help

WWW.SHOPMEDVET.COM

13822 WEST BOULTON BLVD. METTAWA, IL 60045

Phone 800-544-7521

1118

WWW.SHOPMEDVET.COM

Fax 800-204-2177

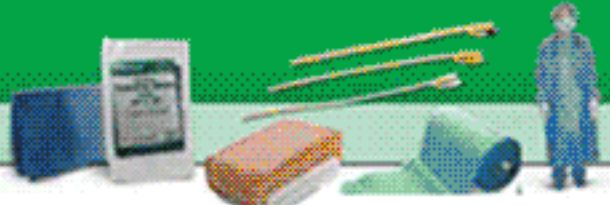

Suction Supplies

Yankauer Handle with Tubing

Yankauer features a slip-resistant handle for a secure grip. A smooth inner surface for maximum non-occluding flow and uniform tip to base diameter for fast evacuation. Yankauer Handle is also available with tubing in a 6 foot length.

YANK-HT w/tubing \$2.29/ea

BUY NOW



Yankauer Handle

Yankauer features a slip-resistant handle for a secure grip. A smooth inner surface for maximum non-occluding flow and uniform tip to base diameter for fast evacuation. Yankauer Handle is also available with tubing in a 6 foot length.

YANK-H Handle, N/S \$0.65/ea

BUY NOW



Jorvet Yankauer Suction Handle



Small removable tip has six vertical holes for suction. Fits standard suction hose. 22cm L.

JOR489ME Economy, Metal, 22cm L. \$22.75/ea
 JOR489M Metal, 22cm L. \$33.00/ea



Yankauer Suction Handle w/Thumb Control

Yankauer Suction Handle with thumb control vent. Same as JOR489, only with a thumb control vent. Small vent hole on the handle creates suction when blocked by thumb.

JOR489A 1/pkg. \$3.37/ea

BUY NOW



Jorvet Yankauer Suction Handle



For aspiration of fluids during surgical procedures. Nylon. Can attach to JOR488 suction hose, as shown.

JOR489 Sterile, 1/pkg. \$3.22/ea

BUY NOW



Suction Tubing

Top Quality - Sterile Suction Tubing

50216 3/16" x 6' \$1.10/ea
 50221 3/16" x 10' \$1.40/ea
 50246 1/4" x 6' \$1.10/ea
 50251 1/4" x 10' \$1.40/ea
 50252 1/4" x 12' \$1.50/ea

BUY NOW

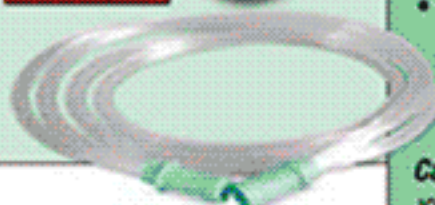

Jorvet Suction Hose

BUY NOW

Top Quality - Sterile Suction Tubing

JOR488 1/4" I.D. x 6'. Sterile, 1/pkg. \$3.78/ea
 JOR488L 1/4" I.D. x 12'. Sterile, 1/pkg. \$4.50/ea



Suction Canister

Unlike liner systems, these canisters are rigid so there are no hidden dangers, no extra parts to clean, no potential for puncturing and no disassembly required. Plus, they're disposable. Your staff can throw away the whole canister after each case. There's no cleaning, substantially reducing the risk of infection. Hard canisters are easier to set up and easier to change out. Over time, they will save you time and money. And because the suction is better, applications get the maximum vacuum required.

SC800 800cc \$3.95/ea **BUY NOW**

Suction Canister

JOR459D1A 1200cc \$13.50/ea
 JOR459D1 800cc \$11.10/ea



Pooler Suction Handle



Distal 1/3 end is vented with many holes. Fits standard suction hose. Screws apart for easy cleaning. Stainless steel.

JOR489P Metal, 8mm dia. 22cm L. \$34.50/ea
 JOR489PS Plastic \$5.70/ea

BUY NOW



Jorvet Aspiration Suction Unit

BUY NOW

This portable unit will provide powerful suction via an aspirator pump motor. Intraoperative suction of blood or body fluids. Attach to endoscope to keep field of vision clear or sample collection.

Features:

- Aspiration range 0-27" Hg
- Powerful 1/5 hp motor, most other units have only 1/10 hp
- Compact 14" L x 5 1/2" W x 10 1/2" H (35cm x 14cm x 26cm)
- Inline hydrophobic filter protects motor
- 800cc Storage canister
- Lightweight, 12.4 lbs.
- Five-year warranty



JOR459 14" L x 5 1/2" W x 10 1/2" H \$390.00/ea

Canister Only

JOR459D1A 1200cc \$13.50/ea
 JOR459D1 800cc \$11.10/ea



Lamps/Lights, Cautery Pens/Units

Surgical Head Lamp

Veterinarians often have a need for additional extra light during many procedures from surgery to oral exams. This inexpensive headlight provides hands free adjustable light-when and where you want it.

- Adjusts easily to all sizes
- Padded brim for comfort
- Battery operated (3 AAA included), no cords or wires
- LED bright light lasts thousands of hours
- LED light is adjustable to get light where you want it



BUY NOW

JOR1036 LED Headlight with Batteries \$134.00/ea

Jorvet Thermal Cautery Unit

BUY NOW

The TCU provides all the cautery power necessary for treating the numerous minor surgical conditions seen by veterinarians in everyday practice. The cautery unit is ideal for dermatological and ophthalmologic applications, or any procedure that requires accurate hemostasis. The autoclavable handpiece with six-foot cord accepts an assortment of reusable thermal cautery electrodes, allowing maximum flexibility to perform a wide variety of procedures. Unit comes with 3 tips.

Other benefits include:

- No aberrant radio frequency currents to cause
- Unintended tissue damage or shock.
- Unlike disposable battery powered cauterizers, the TCU maintains the desired temperature during tissue contact and does not rapidly diminish.
- 50" (12.7cm) D x 5" (12.7cm) W x 8"
- (20.3cm) H, 4 lbs. (1.8kg)
- Warranty: 1 year

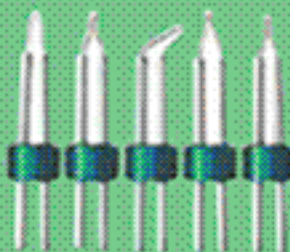

Vet Use

Jorvet



JOR848	Cautery Unit	\$675.00/ea
JOR848D1	Non-sterile; may be autoclaved	\$183.00/ea
Tips		
JOR846A	Loop Tip	\$68.00/ea
JOR846B	Fine Flat Tip	\$68.00/ea
JOR846C	Angled Loop Tip	\$68.00/ea
JOR846D	Ball Point Tip	\$71.00/ea
JOR846E	Fine Tip	\$68.00/ea

Optimal Headlamp Magnifying Lens

Jorvet

Attaches to JOR1036 (sold separately) just below light.

JOR1036D4	Magnifying Lens 2.75 x Working Distance 6"	\$49.00/ea
JOR1036D3	Magnifying Lens 2.25 x Working Distance 8"	\$49.00/ea
JOR1036D2	Magnifying Lens 1.75 x Working Distance 14"	\$49.00/ea
JOR1036D1	Magnifying Lens 1.50 x Working Distance 20"	\$49.00/ea

BUY NOW

Jorvet Halogen Penlight

The Jorvet Penlight with halogen bulb offers 400 percent more candle power than standard penlights.

JOR1148H Uses two "AA" batteries, included. \$33.00

BUY NOW



Jorvet

Cordless Cautery Convenient Kit

BUY NOW

Features:

Hand piece uses two AA batteries (included)

- (4) Replaceable cautery tips:
- (2) 1/2" Fine electrode, useful for hemostasis control
- (2) 1/2" Loop electrode for wide use, such as small skin tumors
- Delivers high temp up to 2250° F
- All tips fit easily into the hand piece



JOR313	Complete Kit	\$67.00/ea
JOR313W	Fine tip 1/2"	\$12.00/ea
JOR313Z	Loop tip 5"	\$12.00/ea
JOR313Y	Fine tip 5"	\$12.00/ea
JOR313X	Loop tip 1/2"	\$12.00/ea
JOR313D1	Sterile sleeves, 10 pack	\$28.50/pk

Portable Cordless Cautery Pen

BUY NOW

Small portable cautery, excellent for hemostasis. Uses AA batteries (included). 5/8" fine tip. Cordless and lightweight. High Temp 2250F.

JOR313A	High Temp 2250°F	\$36.00/ea
JOR313B	Low Temp 1350°F	\$29.40/ea

Jorvet



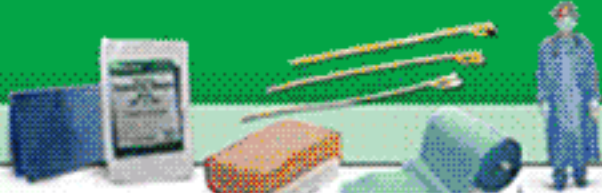

Jorvet Electrosurgical Unit

The most affordable unit available for today's veterinary surgeon. With more than enough power for any procedure.

Features:

- 3 operating modes at the turn of a dial
- Fully filtered: smooth cutting
- Fully rectified: cutting & coagulation
- Partially rectified: Coagulation: larger bleeders
- 10 different power settings
- Wide selection of electrodes included
- Includes ground plate



JOR470 3 Modes \$735.00/ea



BUY NOW

Electrosurgical Unit Electrode

The most affordable unit available for today's veterinary surgeon. With more than enough power for any procedure.

JOR470D1 One Prong and autoclavable \$94.50/ea



Electrosurgical Unit Electrode

Autoclavable. 1/16" Use only with JOR470 unit
NOTE: DO NOT store in liquids.

- | | | |
|-----------|------------|------------|
| JOR470DT2 | Large Loop | \$12.00/ea |
| JOR470DT3 | Small Loop | \$12.00/ea |
| JOR470DT5 | Fine Wire | \$12.00/ea |
| JOR470DT4 | Heavy Wire | \$12.00/ea |

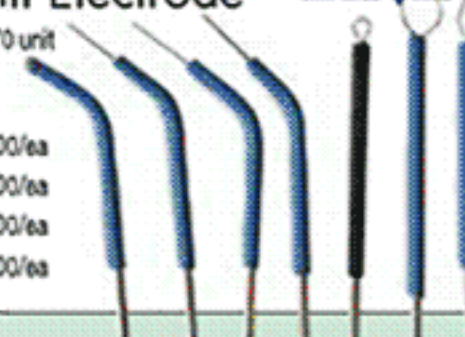

- The wide range of JorVet Electrodes come in four different types.
- 3/32" Autoclavable. Use only with JOR484m
- BIPolar. Autoclavable. Use with JOR484m and JOR470 (needs bipolar convertor)
- 3/32" Disposable. Autoclavable. Raised grip for easy removal. Use only with JOR484m unit
- 1/16" Autoclavable. Use only with JOR470 unit

Jorvet Reusable Electrodes

Autoclavable. 3/32"

BUY NOW



- | | | |
|----------|-------------------------|------------|
| JOR484A1 | Angled Fine Needle | \$54.75/ea |
| JOR484A2 | Angled | \$42.75/ea |
| JOR484A3 | Angled Sharp | \$46.50/ea |
| JOR484A4 | Angle, Ball | \$52.50/ea |
| JOR484A5 | Straight Ball | \$51.00/ea |
| JOR484A6 | Straight Needle | \$51.00/ea |
| JOR484A6 | Straight Needle | \$51.00/ea |
| JOR484A7 | Long Straight Ball | \$49.50/ea |
| JOR484A8 | Long Straight Needle | \$49.50/ea |
| JOR484A9 | Triangle electrode 1/2" | \$26.50/ea |



Reusable Bipolar Forceps

BUY NOW

Autoclavable



- | | | |
|----------|--------------------------------|-------------|
| JOR484B1 | Fine Forceps. 5" | \$260.00/ea |
| JOR484B2 | Medium Forceps. 5 1/2" | \$260.00/ea |
| JOR484B3 | Curved Fine Forceps. 5" | \$260.00/ea |
| JOR484B4 | Curved Fine Forceps. 7" | \$260.00/ea |
| JOR484B5 | Straight Fine Forceps. 7" | \$260.00/ea |
| JOR484B7 | Bayonet Fine Forceps. 7 1/2" | \$260.00/ea |
| JOR484B6 | Bayonet Medium Forceps. 7 1/2" | \$260.00/ea |
| JOR484BC | Bipolar Cord for JOR484m | \$85.00/ea |

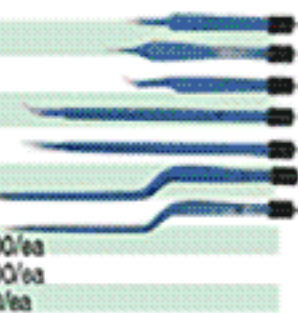

Disposable Electrode

BUY NOW



3/32", 25/box, standard needle

- | | | |
|-----------|-------------------------|------------|
| JOR484AD4 | Standard Needle. 25/box | \$68.00/ea |
| JOR484AD5 | Standard Blade. 50/box | \$88.00/ea |



Jorvet Reusable Loop Electrode

Great for removing skin tumors. 3/32", Loop, 3/8" dia

- | | | |
|-----------|----------------------|------------|
| JOR484AD1 | re-usable 1/4", each | \$44.75/ea |
| JOR484AD2 | Loop, 3/8" dia | \$42.50/ea |
| JOR484AD3 | Re-usable 1/2", each | \$43.00/ea |



Jorvet Diamond Electrode

Diamond Electrode. Reusable. 3/32".

- | | | |
|-----------|------------------------|------------|
| JOR484A13 | Diamond electrode 1/4" | \$26.50/ea |
| JOR484A14 | Diamond electrode 1/8" | \$26.50/ea |



Triangle Electrode

- | | | |
|-----------|------------------------|-----------------|
| JOR484A11 | 1/8", Reusable. 3/32". | 1/8" \$26.50/ea |
|-----------|------------------------|-----------------|



Jorvet Electrode Autoclavable 1/16"

Autoclavable. 1/16" Use only with JOR470 unit
NOTE: DO NOT store in liquids.

- | | | |
|-----------|-----------------|------------|
| JOR470DT1 | Diamond Loop | \$12.00/ea |
| JOR470DT2 | Large Loop | \$12.00/ea |
| JOR470DT3 | Small Loop | \$12.00/ea |
| JOR470DT4 | Heavy Wire | \$12.00/ea |
| JOR470DT5 | Fine Wire | \$13.50/ea |
| JOR470DT7 | Small Oval Loop | \$12.00/ea |
| JOR470DT9 | Ball Electrode | \$12.00/ea |

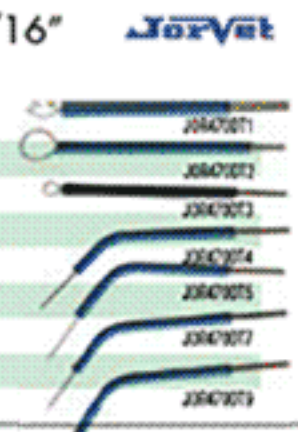

Electrosurgical Units & Accessories

Bovie 2250 Digital Electrosurge Generator

A more powerful unit is needed when doing specialized endoscopy procedures like OHE's or spays. This unit will work well with Richard Wolf's Powerblade and other brands of bipolar endoscopy equipment. The increased power is the cut format: 200 watts, fulguration: 80 watts, bipolar: 80 watts. Uses the same JOR484 3/32" tips shown on the following page. 12.3"W x 16.3D x 6"H. Accessories included:

- Two disp hand pieces (JOR484mdla)
 - Autoclavable hand piece (JOR484mdlc)
 - Reusable body or ground plate
 - Five different electrodes
 - Two Electrodes - standard needle (JOR484ad54)
 - x Three Electrodes - standard blade. (JOR484ad55)
- Two-year warranty Optional item: JOR484xd1 Bipolar Foot Switch

BUY NOW



JOR484X **JorVet** \$6,290.00/ea
 JOR484TA Table Top Stand \$266.00/ea



Deluxe 1250 Bovie Electrosurgical Unit

This is a top-of-the line Electro surgical unit made by the original Bovie Company. They first invented the Electro surgical unit in the 1920s. The complete table top unit is fitted with veterinary specific equipment. Five modes: cutting, cutting/coagulation, coagulation, fulguration, bipolar. User has option of handpiece finger switch or foot control Rotary dial operates power; shown in 1 watt increments via LED readout

- Reusable body pad (ground plate)
- Built-in bipolar (requires optional foot pedal)
- Five 3/32" electrodes; interchangeable with other same size brands
- 101/4"W x 51/2"H x 10"D, 14 lbs.
- U.L. approved Accessories Included:
- Two Disposable Handpieces (JOR484md1a)
- Autoclavable Handpiece (JOR484md1c).

JOR484M NOTE: Bipolar forceps and cord sold separately. Must purchase foot pedal switch for bipolar. JOR484M99 Foot pedal for bipolar applications. \$2,880.00/ea



BUY NOW

JOR484MV 220V 220V\$3,600.00/ea

Accessories

Handpiece for Disposable Cautery

JOR484MD1A Disposable handpiece for Bovie 1250 electrosurgical unit \$14.25/ea

Jorvet Autoclavable Handpiece

Bovie 1250 autoclavable handpiece
 JOR484MD1C \$54.00/ea

Reusable Bipolar Forceps

The foot pedal is necessary for bi-polar procedures
 JOR484MD9 Foot pedal for bovie 1250 \$502.00/ea

Jorvet Foot Switch

Foot pedal for JOR484, Electrosurgical Generating System
 JOR484D2 \$139.00/ea

Deluxe Electrosurgical Grounding Plate & Cord

Can only be used with JOR484 unit
 JOR484D3 \$188.00/ea

Ground Plate Cord for JOR484M

JOR484MD4 \$102.00/ea

Ground Plate Cord Only

Ground Plate cord only for J484v
 JOR484D3C \$110.00/ea

Ground Plate Only

Ground plate only for JOR484 & JOR484M
 JOR484D3P \$92.00/ea

JorVet

JorVet

JorVet

JorVet

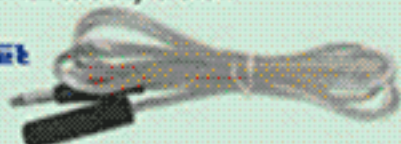

Tube Gauze

BUY NOW

Commonly used in bandaging cat declaws. Also can be used as a stockinette on cats and smaller animals. A very fine weave of 100% cotton that is knitted in a continuous seamless tube. Roll in dispensing box

JOR290A Roll 5/8" (w) x 50 yards \$18.00/ea
 JOR290B 1" x 50 yards \$21.00/ea



Tube Gauze Applicator (for 5/8" tube gauze)

JOR290AP Metal applicator cage for 5/8" tube gauze \$43.50/ea

Verruca-Freeze Starter Kit

RXVERRUCA-L Cryo Buds large, 8-10mm, 30/pk \$35.00/pk
 RXVERRUCA-REF Refill Canister; 60-70 freezes \$335.00/btl
 RXVERRUCA-M Cryo Buds medium 4-6mm, 30/pk \$35.00/pk
 RXVERRUCA-S Cryo Buds small, 2mm, 30/pk \$35.00/pk
 RXVERRUCA starter kit: 60-70 freezes with cones and buds \$399.00/pk

TOP SELLER



Jorvet Smoke Shark

Noxious smoke is generated when using either an electrosurgical unit or surgical laser. At the very least, smoke is a nuisance odor, and at worst, an occupational health hazard. The smoke shark is designed to remove smoke and particulate matter generated by electrosurgical generators or lasers at the operative sight. The Smoke Shark unit consists of a smoke evacuation power unit, filter canister, and various tubing attachments. The four stage filter captures particles down to 0.01µm with over 99.99 percent efficiency. The filter has an 18-hour shelf life and contains 24 ounces of carbon, giving it superior ability to eliminate odors. Tubing (6) connects the filter to the surgery site. A small arm stand holds the tubing close to the surgical site without contaminating the sterile field. Features:

- Line voltage: 120 VAC ± 10%
- Line frequency: 50-60 Hz
- 17.78 cm (7") W x 29.85 cm (11.75") H x 46.36 cm (18.25") D
- Weight: < 6.5 kg (< 14 lbs.) w/o filter

JOR483 Complete with:
 • Smoke Shark power unit
 • Long life filter
 • 6" tubing (24/pk)
 • Foot switch/v
 • Arm stand

JorVet

NEW

\$1,960.00/ea



Smoke Shark Arm Stand

JOR483D5 \$176.00

Smoke Shark Footswitch

JOR483D4 \$188.00

Smoke Shark (Power Unit Only)

JOR483D6 \$1,410.00

Smoke Shark Tubing

JOR483D3 Tubing, 7/8" x 6 ft. (24/pk) \$186.00/ea

JorVet

BUY NOW



Surgical and Exam Supplies

Underpads, Biosecurity Apparel & Pill Counting

Disposable Underpads

Disposable Underpads economy weight, light absorbency, feature diamond-embossed fluff-fill to help control fluid leaks. Added embossed polypropylene backing controls slipping to reduce the risk of leaks on patients and bedding.

UPAD1724CS	17" x 24" 300/cs	\$39.00/cs
UPAD2324CS	23" x 24" 200/cs	\$39.00/cs
UPAD2336CS	23" x 36" 150/cs	\$39.00/cs



Underpads

Protection Plus® Disposable Underpads deluxe weight, heavy absorbency, feature diamond-embossed fluff-fill to help control fluid leaks. Added embossed polypropylene backing controls slipping to reduce the risk of leaks on patients and bedding.

Economy Weight Disposable Underpads

281227	30" x 30" 150/case	\$41.00/cs
--------	--------------------	------------

Standard Weight Disposable Underpads

281230	17" x 24" 300/case	\$49.00/cs
281241	23" x 24" 200/case	\$49.00/cs
281242	23" x 36" 150/case	\$49.00/cs
281245	30" x 30" 150/case	\$51.00/cs

Deluxe Weight Disposable Underpads

281260	17" x 24" 300/case	\$54.00/cs
281264	23" x 36" 150/case	\$53.00/cs

BUY NOW

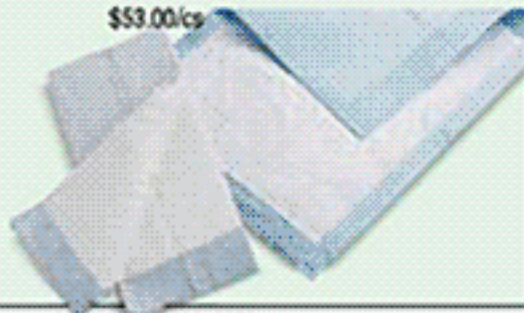

Pill Counting Tray

Handy device for counting out pills for accurate prescription count. Plastic. (spatula not included)

JOR697 6"W x 8"L \$17.40/ea

BUY NOW

JorVet

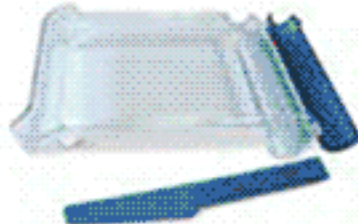

Veterinary Biosecurity Protective Apparel Kit

Veterinarians and associated animal health care workers are in contact with some highly contagious diseases. There is a real need for biosecurity to prevent that pathogen from spreading further. Outbreaks of highly contagious diseases like:

- Equine Rhinopneumonitis (herpes)
- Canine Influenza
- Salmonella
- Equine strangles and others

Veterinarians and staff are at risk of becoming the vehicle that spreads these diseases further. JorVet, in cooperation with a leading veterinary teaching hospital has developed a protective apparel kit that provides protective apparel and reduces the risk of these dangerous pathogens being spread by the very person responsible for controlling it.

The kit consists of:

- White coveralls with hood and zipper
- Procedure mask with ties
- Disposable blue plastic boots (pr) JOR100B
- Disposable purple nitrile gloves (2 pair)
- Alcohol wipes (2)
- Biohazard disposal bag
- Zip lock storage bag with direction

JOR1035XL Extra Large size Note: Sizing runs small \$27.00/ea

JorVet



BUY NOW

JorVet Rectal Ring

BUY NOW

JorVet rectal rings are precision-machined acrylic plastic with tapered ends for easy insertion.

JOR155B	5/8 x 2, 24 pk.	\$34.00/pk
JOR155C	3/4 x 2, 24 pk.	\$34.50/pk
JOR155D	7/8 x 2, 24 pk.	\$34.50/pk
JOR155E	1 x 2, 24 pk.	\$36.00/pk



JorVet

Fecal Loop

Inexpensive plastic loop with slotted ends for quick and easy fecal samples. Reusable. This can easily be inserted into the rectum and a small amount of fecal material trapped in the loop. Can be cleaned, disinfected, and used repeatedly. Two convenient sizes available.

JOR147	Standard size, 9" x 3/8"	\$2.75/ea
JOR147P	Puppy & Kitten size, 4 3/4" x 1/4"	\$2.75/ea

BUY NOW

Drench Pump

BUY NOW

Drench Pump for administering large doses of fluid orally. A continuous flow pump that puts out liquid on both the up and down stroke.

JOR132 Pump \$75.00/ea



Irrigating Cannula

These plastic cannula are used for irrigation of the lacrimal ducts, wounds, glands, etc. Rounded ends. Flexible tip. Sterile.

JOR150A Small, 5/pk \$39.00/pk

BUY NOW

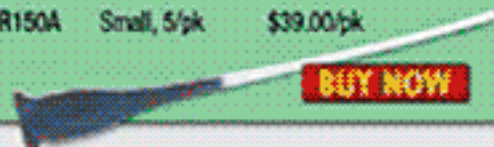

Silver Nitrate Applicator

Applicators with silver nitrate. These 6" applicators come 100 per package.

SNA6 100/pk \$37.95/ea

BUY NOW



Surgical and Exam Supplies

Depressors, Thermometers, & White Goods

Wooden Tongue Depressor

Made from close-grained northern white birch, with high tensile strength and a smooth, polished surface. These tongue depressors are odorless, tasteless and offer great patient comfort.

TDJ	Jr, Non-Sterile 500/bx	\$6.49/bx	10+\$5.99/ea
TDS	Sr, Non-Sterile, 500/bx	\$6.49/bx	10+\$5.99/ea
TDSS	Sterile, 100/bx	\$3.95/bx	10+\$3.49/ea

BUY NOW



Jorvet Wooden Tongue Depressor

Quality birchwood tongue depressors enjoy a wide variety of uses around the veterinary clinic. 500/bx 10 boxes/case, standard size 6" x 3/4".

JOR196 500, 6" x 3/4". \$9.60/bx

BUY NOW

Jorvet Tongue Depressor

For small animals. Excellent illumination for oral and laryngeal exams. Use with JOR114bh lightsource. Cold sterilization only.

JOR114T 2 pack \$5.40/ea

Jorvet

BUY NOW

Digital Thermometer

Our digital thermometers provide accurate temperatures in about 60 seconds. These thermometers have a simple push-button start and a large LCD screen for easy readings. Disposable sheaths allow for sanitary oral, rectal or auxiliary use.

DIGITAL Each \$4.99/ea

DIGITAL



Thermometer Sheath

Thermometer sheath, rectal, digital, pre-lubricated

MDS9608 100/Bx \$6.33

BUY NOW



Small Animal Thermometer

Quality 4" stubby bulb rectal thermometer with a tri-top end, allowing non-slip insertion and removal, as well as not rolling off a flat surface. Complete with handy 2-piece plastic carrying case for safety and hygiene. Gold glass backing for quick and easy readouts. Full Fahrenheit scale of 96° to 106°. Guaranteed to comply with ASTM E667 specifications.

JOR460 12/bx. \$13.20/dz

JOR460

BUY NOW

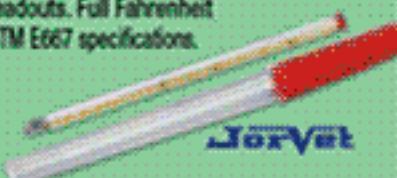

Thermometer and Case

Gold colored backing for quick and easy Fahrenheit scale readouts. Heavy-duty with ring top. 5"L. Available with or without a case.

JOR1870 1 Dozen, Without Display Card \$36.90/bx

JOR1870D 1 Dozen, Comes with Display cards. \$36.90/ea

Jorvet

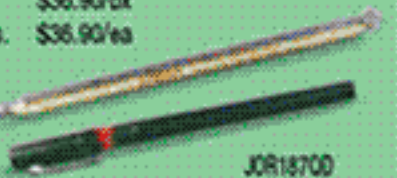

JOR1870D

Cotton-Tipped Applicators

Single end Non-Sterile. 1000 per box.

CTA6 6", 1000/bx \$4.99/bx
CTA3 3", 1000/bx \$4.99/bx

as low as

10+\$4.49/ea

BUY NOW

Jorvet Cotton-Tip Applicator

Our Jorvet cotton tip applicators are 6"L and come with a wooden stem and single cotton tip. 100/bag, 24 bags/box.

JOR195 6", 100/bag, 24pk. \$14.10/bx

Jorvet

Applicator Sticks

Jorvet

6" hardwood applicator stick useful for mixing and stirring compounds and lab samples. Handy zip lock bag. 100/bag, 24 bags/carton.

JOR195A 100/bag, 24-pack \$9.00/ct

BUY NOW

Sundry Jars

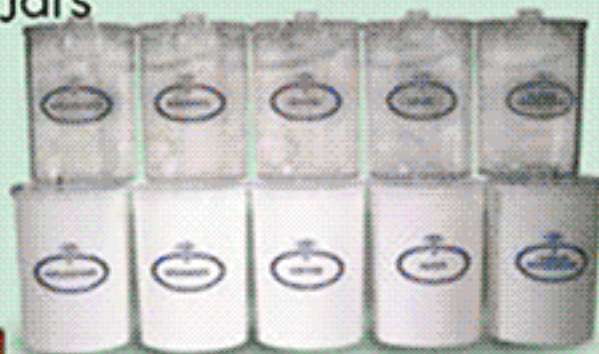

BUY NOW

These deluxe sundry jars feature unbreakable plastic in either white opaque or clear polystyrene. Jars are permanently labeled in blue and come with clear lids for easy viewing.

39-800	White Opaque 5/Set Labels: Applicators, Bandages, Cotton, Gauze & Tongue Depressors.	\$22.00/ea
39-801	White Opaque, Each, Unlabeled	\$5.00/ea
39-802	Clear 5/Set, Labels: Applicators, Bandages, Cotton, Gauze & Tongue Depressors.	\$22.00/ea
39-803	Clear, Each, Unlabeled	\$5.00/ea

Non-Sterile Cotton Balls

COTBALL Medium, 4000/cs \$14.99/cs
COTBALL-LG Large, 2000/cs \$19.99/cs

Oasis

TOP SELLER



SEE OUR COTTON & GAUZE SECTION FOR A FULL RANGE OF WHITE GOODS

13822 WEST BOULTON BLVD. METTAWA, IL 60045

WWW.SHOPMEDVET.COM

Phone 800-544-7521

Fax 800-204-2177

Surgical and Exam Supplies

Lube, Tourniquets & Disposable Towels

Jorvet Gallon J-Jelly Lube

BUY NOW

An ideal all around lubricant for rectal and obstetrical procedures. J-Jelly is greaseless, water soluble, and non-irritating. It will not harm rubber, plastic, or glass surfaces. Contains methylcellulose.

JOR109JB Gallon \$19.95/gl
 JOR109F 8 oz. reusable flask \$3.45/ea



Lubricating Jelly

BUY NOW

An ideal water soluble lubricant for general needs.

LUBE-J 4 oz.

\$1.50/ea



J-Lube Powder

Concentrated powder that dissolves easily in water and is a very effective obstetrical lubricant. J-LUBE® is completely inert and non-irritating. 10 oz. plastic bottle with shaker top makes 6-8 gallons of lubricant. For veterinary use only.

JOR109 10 oz., 4.5 meters \$11.70/ea



Lubricating Jelly Sterile

LUBE-5G150 5gm foil pack \$10.99/bx

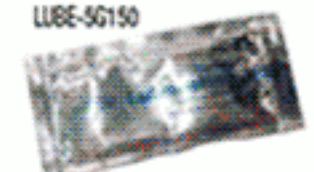

Nye Model Tourniquet

This tourniquet features a quick release metal clip which can be unlocked using one hand. Ideal for *N* applications. Strap will not roll or pinch. Tension can be released or applied at will. Instantly removed by depressing the button. It is very durable and can withstand repeated use and sterilization. Can also be used as a canine muzzle.

JOR130 Nye-Model \$12.00/ea
 JOR130R Spare Rubber for Nye Tourniquet \$3.15/ea

BUY NOW



Nylon Tourniquet

This tourniquet looks so simple but it works! Nylon elastic cord has a better stretch with a tighter fit. It is easier to tighten and release with one hand. Plastic clasp holds tough with no slipping. Inexpensive. Blister packaged in pairs.

JOR605 Pair of 2 \$6.15/pr

BUY NOW

Quick Release Tourniquet

This new tourniquet has a quick release at the flick of a button. One hand can hold the syringe, the other can release the tourniquet. Broad blue band of stretch elastic gives a very tight fit.

JOR130X Quick Release \$24.00/ea

BUY NOW



Multi-Fold Towel

Multi-fold towels, 9.25" x 9.25", 4000/cs, various manufacturers.

P-TOWEL White \$24.00/cs

BUY NOW

Paper Towel C-Fold

High-quality single towels help prevent waste and cross-contamination

TOWEL-CFOLD

2400/Case C-Fold \$30.29/cs

BUY NOW

Professional Towel Tissue/Poly

BUY NOW

These standard tissue/poly towels catch fluid and hold it, making them ideal for washing, wiping or draping. They combine durability with disposability. 13" x 19"

TOWEL-TP 13" X 19" 2-Ply 500/cs \$22.95/cs
 TOWEL-TPT 13" X 19" 3-Ply 500/cs \$29.95/cs

Professional Towel

BUY NOW

Designed to be soft and gentle yet strong and durable. 13" X 19", 3 ply, 500/cs

TOWEL-P 13" X 19" 3-Ply 500/cs \$22.99/cs

Enema Solution 4.5 Oz

Solutions are pre-bottled and ready to use. Anatomically correct tips are pre-lubricated for a safe and relaxed insertion. Protective shields help to prevent contamination. One-way safety valve controls flow and helps prevent reflux. Convenient round squeeze bottle is easy to hold.

ENEMA 4.5oz \$1.85/ea

BUY NOW



Exam Penlight

BUY NOW

These lightweight pens provide a high-intensity light in a durable casing and can be easily clipped to pockets.

PLITE 6/Pkg \$8.25/pk



Surgical and Exam Supplies

Surgical Instruments, Surgical Mesh & Animal Microchips

Utility Bandage Scissors

BUY NOW



Vendor	Item#	Details	Price
ECONOMY	3-169	5.5"	\$3.95/ea
	3-170	7.5"	\$3.95/ea
MID GRADE	02-109	7.5"	\$7.00/ea
MILTEX	MIL5-1000	7.5"	\$21.51/ea
	MIL5-998	6.5"	\$21.51/ea

Lister Bandage Scissors

BUY NOW

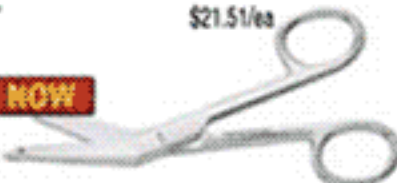

Vendor	Item#	Details	Price
ECONOMY	2-120	3.5"	\$2.95/ea
	2-125	4.5"	\$2.95/ea
	2-130	5.5"	\$2.95/ea
	2-145	7.5"	\$3.95/ea
GERMAN	02-100	3.5"	\$18.00/ea
	02-101	4.5"	\$18.00/ea
	02-102	5.5"	\$18.00/ea
	02-103	7.5"	\$18.00/ea
INTEGRA/ MILTEX	MIL5-510	3.5"	\$50.63/ea
	MIL5-512	4.5"	\$52.58/ea
	MIL5-516	7.25"	\$81.70/ea

Spencer Stitch Scissors

Vendor	Item#	Details	Price
ECONOMY	4-360	3.5"	\$2.95/ea
GERMAN	02-112	3.5" Straight	\$17.00/ea
INTEGRA/ MILTEX	MIL9-100	3"	\$71.99/ea

Taylor Hammer

BUY NOW



Vendor	Item#	Details	Price
ECONOMY	11-1275	Chrome, 7.5"	\$3.95/ea

Leighton Bone Pin Introducer

designed to help reduce overriding fractures and facilitate insertion of the intramedullary pin into the distal segment of a fracture.

JOR158 (see illustration for explanation of use) \$170.00/ea



BUY NOW

Left Curved Hoof Knife

BUY NOW



Vendor	Item#	Details	Price
JORGENSEN	JOR32HWL	Wood Handle, Left, Curved, Blade 5/8" W x 2 3/4" L.	\$30.90/ea

BUY NOW

Swiss Knife

Vendor	Item#	Details	Price
JORGENSEN	JOR32E	7.25"	\$27.50/ea

Left Curved Hoof Knife

Vendor	Item#	Details	Price
JORGENSEN	JOR32P	each	\$1.80/ea

Polyester Surgical Mesh

Surgical mesh is useful to repair soft tissue defects such as perineal and umbilical hernias. Mesh loop diameter 1mm.

JOR1054 60mm (2.4") x 80mm (3.2"). Sterile 1/pk. \$34.00/ea

BUY NOW

AKC Companion Animal Recovery Microchips

AKC Companion Animal Recovery Microchips can be purchased with prepaid enrollment or your clients can enroll themselves. The chips can be read by most universal scanners. AKC CAR microchip enrollment benefits your clients, and is straightforward and includes:

- One time enrollment fee, no annual fees.
- AKC CAR Collar ID Tags.
- 24/7 support from dedicated recovery experts.
- No charge to update records, or limit to the number of updates made.
- Low tag replacement costs.

AKC-10MC	5 chips/box	\$65.00/box	AKC-20MCPPE	20 chips/box with prepaid enrollment	\$399.00/box
AKC-10MCPPE	5 chips/box with prepaid enrollment	\$97.50/box	AKC-IMP	Implanter	\$23.95/ea
AKC-20MC	20 chips/box	\$239.00/box	AKC-PS700	Proscan 700 Universal Scanner (Scans all chips)	\$320.00/ea

BUY NOW



NEW

Surgical and Exam Supplies

Stainless Steel, Exam Table Paper & Blades

Graduated Measures Cup (A)

49-355	3 3/4" x 4 5/8" 16oz	\$24.45/ea
49-356	4 3/4" x 4 1/4" 32oz	\$33.65/ea

Iodine Cup (B)

49-341	3 7/16" x 2" 6 oz	\$3.96/ea
49-342	4 3/8" x 2 5/8" 14oz	\$8.15/ea

Medicine Cup (C)

49-343	2 1/8" x 2" 2oz	\$4.20/ea
--------	-----------------	-----------

Ointment Jar With Handle (D)

49-348	3 1/8" x 2 3/4" 9oz	\$17.00/ea
--------	---------------------	------------

Solution Bowl (E)

49-389	13 5/8" x 4 5/8" 7 qt	\$44.53/ea
--------	-----------------------	------------

Sponge Bowl (F)

49-383	4 1/4" x 2" 12oz	\$7.00/ea
49-385	5 9/16" x 2 9/16" 29oz	\$9.90/ea
49-386	6 1/4" x 2 3/4" 36oz	\$13.90/ea
49-387	7 9/16" x 3" 64oz	\$22.50/ea
49-346	1" x 4"	\$13.50/ea

Catheter and Instrument Tray with Flat Cover (G)

49-361	12 1/4" X 7 3/4" X 2 1/4"	\$38.25/ea
--------	---------------------------	------------

Dressing Jar (H)

49-333	4 1/8" X 2 1/4" With Cover 1/2 Qt	\$15.58/ea
49-334	4 1/8" X 5 1/2" With Cover 1-1/4 Qt	\$19.13/ea
49-335	4 1/8" X 6 1/4" With Cover 1-7/8 Qt	\$27.63/ea

Emesis Basin (I)

49-380	9 7/8" x 4 1/2" x 2 1/4" 26oz	\$14.52/ea
49-381	6 5/8" x 3 1/2" x 1 1/2" 10oz	\$7.90/ea
49-382	8 1/8" x 3 5/8" x 1 5/8" 12oz	\$11.33/ea

Forceps Jar (J)

49-351	2 1/4" X 7"	\$22.30/ea
--------	-------------	------------

Tumbler (K)

49-344	2 7/8" x 3 1/8" 7oz	\$5.90/ea
--------	---------------------	-----------

Instrument or Spay Pack Tray

JOR399B	Top: 12" x 7 3/4" x 1 15/16", Bottom: 10 1/2" x 6 1/4" x 2"	\$34.50/ea
---------	--	------------

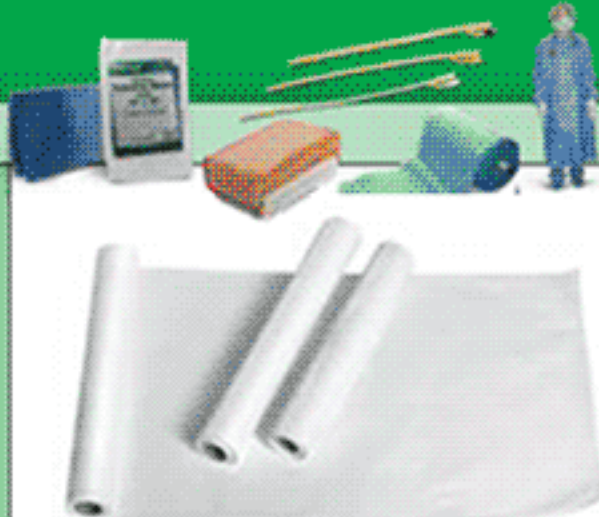

Exam Table Paper **BUY NOW**

Exam Table Paper: Medline's absorbent table paper protects exam tables from dirt and moisture while offering comfort and protection for patients. Choose from smooth or crepe finish (crepe is softer, quieter and more absorbent). Crepe is also more textured which will help prevent it from sliding on surfaces. All rolls are mechanically metered for exact length, and individually poly bagged for cleanliness during shipment and storage. White. 2/Case

NON23322	Smooth 18" x 225'	\$51.96
NON25325	Smooth 21" x 125'	\$31.13
NON25326	Smooth 21" x 225'	\$52.19
NON25324	Crepe 18" x 125'	\$28.72
NON23324	Crepe 18" x 125'	\$30.50
NON23325	Crepe 21" x 125'	\$33.65

Exam Table Paper (Deluxe)

NON23326	Smooth 21" x 225'	\$55.00
----------	-------------------	---------

BUY NOW



Jorvet Sterile Swann-Morton Scalpel Blades **Jorvet**

Made from the finest carbon steel. Sizes stocked: 10, 11, 12, 15, 20, 21, and 22. These sharp blades are the result of years of experience plus modern production methods. Individually wrapped. 100/pkg.

Item#	Details	Price
JOR54SA	size 10, 100/box	\$28.50/box
JOR54SC	size 12, 100/pkg	\$28.50/box
JOR54SE	size 20, 100/pkg	\$28.50/box
JOR54SG	size 22, 100/pkg	\$28.50/box
JOR54SB	size 11, 100/pkg	\$28.50/box
JOR54SF	size 21, 100/pkg	\$28.50/box

Thermal Reflective Blanket

3537	84 x 52", 120/case	\$120.00
------	--------------------	----------



See Our Equipment Section for a Complete List of Stainless Steel Products

Swann-Morton Disposable Scalpel



Sizes 10, 11, 12, 15, 21 and 22. 10/box. Sterile

JOR55DA	size #10, 10/box	\$9.90/box
JOR55DB	size #11, 10/box	\$9.90/box
JOR55DC	size #12, 10/box	\$9.90/box
JOR55DD	size #15, 10/box	\$9.90/box
JOR55DE	size #20, 10/box	\$9.90/box
JOR55DF	size #21, 10/box	\$9.90/box

Cardio Link, Excision Kit & Warming Units/Beds

Jorvet The Cardio Link

The Cardio Link is an esophageal cable with four stainless ECG electrodes built in the distal end. It can be linked to all brands of existing ECG monitors. The ECG clips are placed on metal knobs inside a control box. This small box helps protect the clips and prevents interference. Just select Lead II on your ECG machine after proper positioning inside the esophagus after the patient is intubated, and then watch the QRS waveform. The Cardio Link gets rid of cumbersome leads running to all four legs. Three different sizes are available and all will work with the one control box.

Leads available:

- Green lead 12fr (4mm) x 36" long cats, exotics, small dogs
- Blue lead 18fr x 42" long cats, dogs
- Red lead 18fr x 100" long horses

JOR851E	EKG catheter 18fr X 100" red, long red lead for horses. Cable only	\$192.00/ea
JOR851Q	EKG Green lead 12fr (4mm) x 36" long cats, exotics, small dogs	\$300.00/ea
JOR851R	EKG Blue lead 18fr x 42" long cats, dogs	\$300.00/ea

Esophageal Kits

JOR851T	Cardio-Link Esophageal kit w/two 12fr leads	\$300.00/ea
JOR851W	Cardio-Link Esophageal kit w/two 18fr leads	\$300.00/ea

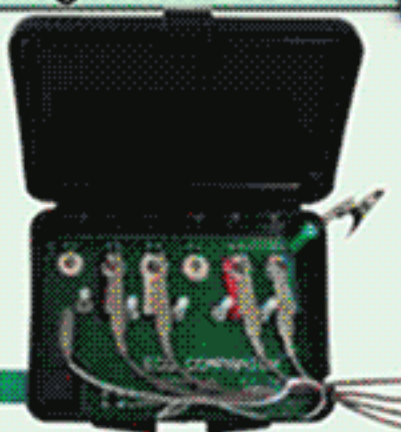

BUY NOW

Jorvet



Jorvet AbsorbENT™ Ear Wick

Ear wicks have been around a long time in human medicine. Recent improvements have made them a valuable adjunct to treating otitis externa for veterinarians. AbsorbENT™ sponges consist of interconnected open cells that are extremely soft and pliable. The interconnected cell structure produces a packing that is exceptionally strong, highly absorbent and virtually lint and fiber free. AbsorbENT™ is designed as an aid in the treatment of otitis externa. When liquid medication is applied to the sterile, compressed sponge, it gently and evenly expands to fill the ear canal dispersing the medication and applying gentle pressure to the tissue.

- Expands rapidly for effective distribution of liquid medication
- Soft, pliable sponge enhances patient comfort while applying gentle pressure
- Compressed and sterile for rapid patient treatment
- Suture can be placed around the end for easy retrieval

Suggested use: Insert Ear Wick and infuse appropriate antibiotic or corticosteroid into sponge. Leave in place for up to a WEEK! The resulting reduction in edema or swelling will cause Ear Wick to come out easily.

JOR1084	9mm (diameter) x 15mm (length) 50/pk	\$99.00/pk
JOR1084A	9mm (diameter) x 24mm (length) 50/pk	\$132.00/pk

Jorvet Anal Sac Excision Kit **Jorvet**

The anal sac excision kit employs a warm liquefied gel injected in to the sac. The gel is in a 2ml cartridge that is first heated to a liquid and loaded in a specially designed syringe. Then, via a 19g blunt needle, is injected into each anal sac. The gel then hardens and gives the sac a readily defined and easily dissected shape for quick removal. Each kit has enough material to do up to eight animals.

JOR101	JOR101d#1 Metal Breech Loading Syringe.	\$66.00/ea
	JOR101d#2 Gel Vials, 8 x 2ml.*	
	JOR101d#3 Blunt Needles, 8 x 19g.*	

8 gel cartridges

JOR101D2	Gel Vials, 8 x 2ml.	\$18.60/pk
----------	---------------------	------------



Snugglesafe Heat Pad **BUY NOW**

This plate-size heatpad will provide up to 12 hours of safe, gentle warmth after being heated in a microwave. No electric wires to worry about. The heat retaining compound inside the pad is non-toxic and environmentally friendly. Also great for whelping puppies.

BC521200	This plate-size heat pad will provide up to 12 hours of safe, gentle warmth after being heated in a microwave. No electric wires to worry about. The heat retaining compound inside the pad is non-toxic and environmentally friendly. Also great for whelping puppies.	\$34.95/ea
----------	---	------------

UP TO 12 HOURS OF WARMTH!

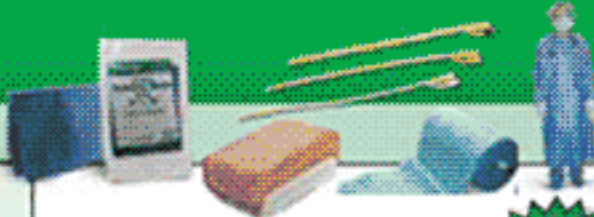

BUY NOW

Jorvet Warming Airbag

Warming Air Blankets. Keeping patients warm during surgery and recovery has always been a challenge. Electric pads have a risk of overheating, circulating water blankets are easily damaged. Our new warm air blankets are a safe, economical solution to this problem. They are made of a silky polyester fabric with an inlay of nylon water proof material to keep the airflow circulating upward towards the patient. These blankets are machine washable (hang to dry) therefore much more economical than other air blankets on the market, which are disposable. There is a 5" diameter round opening with a nylon cord to secure the blanket to any of the major brands of warm air convection units.

JOR1034A	Medium, 36" X 24"	\$49.50/ea
JOR1034B	Large, 48" X 24"	\$54.00/ea
JOR1034S	Set of 3	\$145.00/ea

\$12.79

Jorvet

NEW



Chlorhexidine Solution

RXCHLOR2-GAL 2%, gallon \$19.99/gl

BUY NOW

Chlorhexidine Scrub/Solution

BUY NOW

RXCHLOR4-16 4%, 16oz \$5.87/btl

RXCHLOR4-GAL 4%, gallon \$36.99/gl



Feeding/Stomach Tubes

Jorvet Silicon Gastric Feeding Tube

- Bullet point/cap for luer fitting
- Lateral eye along numerous spots (4)
- Graduated marking
- Can be used long term
- Sterile

BUY NOW

JOR385	8ft. 2.7mm O.D. x 70cm.	\$8.40/ea
JOR385A	12ft. 4.0mm O.D. x 120cm.	\$8.40/ea
JOR385B	16ft. 5.3mm O.D. x 120cm.	\$9.15/ea
JOR385C	20ft. 7.3mm O.D. x 120cm.	\$9.00/ea



Jorvet Silicon Nasogastric Feeding Tube

These silicone feeding tubes are great for administering medication and other fluids orally or nasally. All catheters are fully autoclavable. Lateral eyes are on distal tip. Hinged-attached cap.

JOR386	3.5ft O.D. 1.3mm O.D. 20cm L.	\$45.00/ea
JOR386A	5.0ft O.D. 1.7mm O.D. 20cm L.	\$44.80/ea
JOR386B	5.0ft O.D. 1.7mm O.D. 35cm L.	\$27.00/ea
JOR386D	8.0ft O.D. 2.7mm O.D. 40cm L.	\$30.00/ea
JOR386E	8.0ft O.D. 2.7mm O.D. 55cm L.	\$44.80/ea
JOR386F	8.0ft O.D. 2.7mm O.D. 75cm L.	\$18.00/ea
JOR386G	8.0ft O.D. 2.7mm O.D. 120cm L.	\$33.00/ea
JOR386J	10.0ft O.D. 3.3mm O.D. 55cm L.	\$49.00/ea
JOR386K	10.0ft O.D. 3.3mm O.D. 150cm L.	\$36.00/ea
JOR386M	14.0ft O.D. 4.7mm O.D. 120cm L.	\$49.00/ea



BUY NOW

Silicon Stomach Feeding Tube **JorVet**

Stomach Feeding Tubes for small and large animals. These silicone stomach tubes are for cats and dogs; larger sizes are designed for equine or other large animal use. Constructed of clear tubing with hinged double proximal cap which allows either attaching luer syringe or standard catheter fitting. Also features an openended single luer and distal lateral eyes. Fully autoclavable.

JOR385E	14ft O.D. 3.0mm I.D. 4.7mm O.D. 91cm (36") L.	\$53.20/ea
JOR385F	18ft O.D. 4.0mm I.D. 6.0mm O.D. 91cm (36") L.	\$42.00/ea
JOR385G	24ft O.D. 5.0mm I.D. 8.0mm O.D. 18cm (7") L.	\$26.50/ea
JOR385M	35ft O.D. 6.0mm I.D. 11.7mm O.D. 300cm (120") L.	\$70.00/ea
JOR385P	73ft O.D. 17.0mm I.D. 24.0mm O.D. 300cm (120") L.	\$123.20/ea

Portex Equine Stomach Tube **BUY NOW**

This is the finest quality tube on the market. Made from special siliconized PVC tubing, it has just the right amount of flexibility; it won't become rigid in cold weather and will not soften or kink in hot weather. Each tube has a funnel end to make attachment to a drench pump quick and easy.

JOR106F	Foal, 1/4"H x I.D. 3/8"H x O.D. x 7"L	\$55.50/ea
JOR106S	Small, 5/16"H x I.D. 1/2"H x O.D. x 9"L	\$60.00/ea
JOR106L	Large, 1/2"H x I.D. 3/4"H x O.D. x 10"L	\$91.00/ea
JOR106M	Medium, 3/8"H x I.D. 5/8"H x O.D. x 9"L	\$70.00/ea

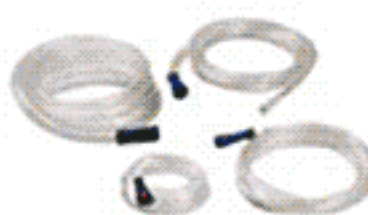

Jorvet Stomach Tubes

Canine **BUY NOW**

Larger size PVC stomach tube for bigger dogs. Useful in gastric lavage or administering larger volumes of fluids with special funnel adaptor. Plus has one lateral eye.

JOR348Q	Medium, 1/4"H I.D. x 3/8"H O.D. x 31/2". For dogs > 40 lbs.	\$16.50/ea
JOR348R	Large, 5/16"H I.D. x 1/2"H O.D. x 4". For dogs < 70 lbs.	\$22.80/ea

Equine **BUY NOW**

End just slightly expanded to fit stomach pumps and dose syringes better. Manufactured from the same superior grade of material as the familiar Portex brand tubes, yet in comparison, about 1/3 the cost, or comparable to standard PVC tubes.

JOR106MG	Medium Equine, 3/8" I.D. x 5/8" O.D. x 9' L	\$42.00/ea
----------	---	------------

E-Z Swallow Equine Stomach Tube **BUY NOW**

With no funnel end, just slightly expanded to fit stomach pumps and dose syringes better. Manufactured from the same superior grade of material as the familiar Portex brand tubes, yet in comparison, about 1/3 the cost, or comparable to standard PVC tubes.

JOR106FG	Foal, 1/4"H x I.D. 3/8"H x O.D. x 7"L	\$36.00/ea
JOR106SG	Small, 5/16"H x I.D. 1/2"H x O.D. x 9"L	\$33.00/ea
JOR106LG	Large, 1/2" H x I.D. 3/4"H x O.D. x 10"L	\$46.50/ea

Enteral Feeding Products **BUY NOW**

This line of products is especially designed for mid-long term enteral feeding. Features of polyurethane feeding tubes: More durable and longer lasting than PVC tubes; Weighted tip with metal tungsten guide end for ease of placement and retention; Stylets included on all sizes; Radiopaque and non-sterile; Many of these tubes will move by peristaltic action to the jejunum after placement in the stomach, which requires longer lengths than standard feeding tubes; Numerical graduations on side of the tube; and complete directions come with the product.

JOR350A	5Fr x22" (56cm) (no weighted tip)	\$15.00/ea
JOR350B	6Fr x22" -weighted tip	\$22.50/ea
JOR350C	6Fr x36" -weighted tip	\$22.50/ea
JOR350D	8Fr x22" (no weighted tip)	\$22.50/ea
JOR350E	8Fr x36" -weighted tip	\$22.50/ea
JOR350F	8Fr x43" -weighted tip	\$24.00/ea
JOR350G	10Fr x36" -weighted tip	\$24.00/ea
JOR350H	10Fr x43" -weighted tip	\$25.50/ea
JOR350J	10Fr x55" -weighted tip	\$27.00/ea
JOR350K	12Fr x43" -weighted tip	\$25.50/ea



Stomach Tube Speculum & Gastronomy Applicator

Canine Stomach Tube

Designed to facilitate the removal or location of esophageal obstructions. The rounded ends allow for atraumatic passage while the metal ball marker assists in the location of any obstruction by X-ray methods. The lateral eye allows for aspiration of gastric contents or administration of fluids. This item is a great addition to any veterinary clinic.



JOR106A	24fr x 76cm	\$25.50/ea
JOR106B	36fr x 76cm	\$27.00/ea

Canine Stomach Tube Speculum

Speculum is useful for passing stomach tube in the conscious patient. The speculum is held in check by the canine teeth going through the two large holes. A 3/8" round hole through the center allows a stomach tube to pass through. By holding jaws firmly closed any chance of biting the tube is eliminated. The hardened blue nylon resists chewing and can be cold sterilized for reuse. 9mm opening.

JOR51M	27fr.	\$8.75/ea
--------	-------	-----------



Large Canine Stomach Tube Speculum

Large Canine Stomach Tube Speculum. 6" x 2" will take up to a 3/8" stomach tube.

JOR51N	6" x 2"	\$9.30/ea
--------	---------	-----------



Feline Stomach Tube Speculum

Smaller size works well on cats and smaller dogs. 6mm opening.

JOR51K	18fr.	\$8.55/ea
--------	-------	-----------



Esophagostomy Feeding Tube

Tubes for long term placement of esophagostomy tubes.

- Soft silicone
- Bio compatible
- Luer fitting
- Retention cap always attached
- Cut to desired length
- Non-sterile
- Packaged individually in chevron pouch



JOR09L	Large	\$7.95/ea
--------	-------	-----------

PVC Stomach Tube

Inexpensive standard PVC stomach tubes with funnel end.

JOR106FE	Foal, 1/4"H x I.D. 3/8"H x O.D. x 7'L.	\$34.50/ea
JOR106LE	Large, 1/2"H x I.D. 3/4"H x O.D. x 10'L.	\$37.50/ea
JOR106ME	Medium, 3/8"H x I.D. 5/8"H x O.D. x 9'L.	\$37.50/ea
JOR106SE	Small, 5/16"H x I.D. 12"H x O.D. x 9'L.	\$34.50/ea

Small Animal Nasogastric Feeding Tube

These small animal feeding tubes are useful in longer term nasogastric oral supplementation. Transparent plastic. Rounded closed tip with two opposing lateral eyes. Luer syringe connector with attached plug. Sterile. 5/pk.



JOR348A	5fr x 15". Cat and dogs.	\$12.90/ea
JOR348B	8fr x 15". Medium dogs.	\$12.90/ea
JOR348C	5fr x 39".	\$12.90/ea
JOR348D	8fr x 42".	\$12.90/ea

EquiVet Large Volume Funnel

A large, over-sized funnel with a special barbed fitting that attaches firmly to stomach tubes.

JOR106X	\$38.70/ea
---------	------------

BUY NOW



Medical Grade Silicone Elastomer Tube

This tubing can be used for a variety of clinical purposes including drains and feeding tubes. Autoclavable. Radiopaque marking. 50cm L.



JOR523A	8mm I.D. x 10mm O.D.	\$7.50/ea
JOR523B	10mm I.D. x 12mm O.D.	\$3.75/ea

BUY NOW

Small Animal Feeding Tube

Red latex rubber with two opposing lateral eyes. X-ray opaque. Sterile. Improved over red vinyl tubes because it is bio-compatible and allows more patient comfort with less rigidity. Can be reused and reautoclaved. 40cm (16"). 5/pk.

BUY NOW

JOR347CC	Tube. 14fr.	\$10.20/pk
JOR347A	Tube. 8fr.	\$10.05/pk
JOR347B	Tube. 10fr.	\$10.20/pk
JOR347C	Tube. 12fr.	\$10.20/pk

These tubes work well with the JOR51k-n stomach tube speculum.

EquiVet Polyurethane Stomach

These all weather tubes give a little more stiffness with longer length for easy passing into the esophagus. The proximal end of the tube has a flared tip especially designed to attach to the standard metal stomach pump's barbed fittings. The distal tip is highly polished.



JOR106FX	Foal, 9mm O.D. x 2.60m (8 3/8") L.	\$42.00/ea
JOR106SX	Small, 13mm O.D. x 3.2m (10 1/4") L.	\$47.00/ea
JOR106LX	Large, 19mm O.D. x 3.6m (11 1/2") L.	\$66.00/ea
JOR106MX	Medium, 16mm O.D. x 3.6m (11 1/2") L.	\$64.50/ea

BUY NOW

Esophagostomy Tube Insertion Device

This line of products is especially designed for mid-long term enteral feeding. Features of polyurethane feeding tubes: More durable and longer lasting than PVC tubes; Weighted tip with metal tungsten guide end for ease of placement and retention; Stylets included on all sizes; Radiopaque and non-sterile; Many of these tubes will move by peristaltic action to the jejunum after placement in the stomach, which requires longer lengths than standard feeding tubes; Numerical graduations on side of the tube; and Complete directions come with the product.

JOR1083	Includes 10 tubes 15fr x 50cm, DVD available.	\$260.00/ea
---------	---	-------------

BUY NOW



NEW

ELD Gastrostomy Tube Applicator

Percutaneous gastrostomy nutritional supplementation is an easy and practical way to feed an anorexic cat or dog. With the advent of special diets like Hill's Prescription A/D and other syringable diets, many previously terminal cases can be saved. However, until now, the only way to place a gastrostomy tube properly was with the aid of a fiberoptic endoscope. JorVet introduces the ELD Applicator that allows the percutaneous insertion of a gastrostomy feeding tube.

JOR389	For cats and small dogs. 18" shaft	\$144.00/ea
JOR389L	For large dogs. 32" shaft	\$156.00/ea



BUY NOW

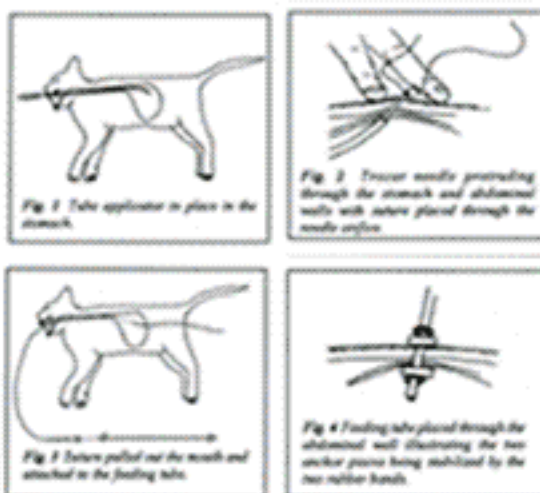

Esophageal Stethoscope Wound Drainage



Jorvet
BUY NOW

Esophageal Stethoscope

Attaches to standard stethoscope

JOR205A	12ft. 20" long	\$19.20/ea
JOR205B	18ft. 20" long	\$19.20/ea
JOR205C	24ft. 20" long	\$19.20/ea

Uterine Lavage Kit

This extra large bore semi-rigid clear pipette has a very high flow. Sterile, 1/4" x 25"L.

- Dual 60" fluid line with spike on one end
- Shut-off clamps on each side of "Y"

JOR288 w/ "Y" tubing \$13.20/ea **BUY NOW**

Gastric Lavage Kit **Jorvet**

A kit designed for use in common gastric emergency conditions where quick and effective lavage or flushing of the stomach is required, (e.g. gastric dilatation volvulus and acute poisonings). The kit includes 3 large bore semi-rigid lavage tubes and a stomach irrigation system that connects to any faucet.

Kit contains:

- (3) Semi-rigid polyethylene tubes
- 1" I.D. x 11/4" O.D. 48"L.
- 7/8" I.D. x 1" O.D. 42"L.
- 5/8" I.D. x 3/4" O.D. 36"L.
- Dura clamp to prevent backflow
- Reducing clamp
- Faucet adaptor
- PVC tubing 3/8" I.D. x 1/2" o.d. x 100cm
- Stomach tube with metal X-ray marker

JOR115 23cm x 76cm. \$63.00/ea



BUY NOW

Jorvet Y Barb Connector

"Y" Barbed Connector.

JORS96	8mm, 2/pk	\$7.35/pk
JORS96A	4mm, 2/pk	\$6.90/pk

BUY NOW

Uterus Pump

JOR27P \$39.00/ea

BUY NOW

Jorvet

Silicon Chest Drainage Tube

Multifenestration with black numbered markings at 2 and 4cm from proximal hole. It has an opened end. White color. Proximal end can be trimmed to desired length.

BUY NOW

JORS24C	0.0. 12ft (4mm) I.D. 2.2mm	\$13.20/ea
JORS24D	0.0. 14ft (4.67mm) I.D. 2.5mm	\$33.60/ea
JORS24E	0.0. 20ft (6.67mm) I.D. 4.0mm	\$35.00/ea
JORS24F	0.0. 30ft (10mm) I.D. 7.0mm	\$35.00/ea

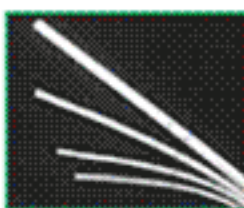

Ewe Prolapse Retainer

Vaginal prolapse. Does not interfere with lambing and can be left in place for extended periods.

JOR26E \$5.10/ea

Jorvet

BUY NOW



Protection Tube for Uterine Biopsy Forceps

This protective tube is passed through the cervix. A biopsy forceps is then passed through it to avoid any contamination on the biopsy sample.

JOR116A 0.0. 15mm x 40cm length \$70.00/ea

BUY NOW



Silver-Plated Metal Tracheostomy Tube 3-Piece Kit (Canine)

German-made. Kit includes:

- Bulb shaped obturator
- Inner cannula for easy clearing
- Outer cannula with wide outer plate for secure attachment (i.e., umbilical tape)

JOR143A	4mm O.D.	\$52.00/ea
JOR143B	6mm O.D.	\$51.00/ea
JOR143C	10mm O.D.	\$54.00/ea
JOR143D	12mm O.D.	\$52.00/ea

Esophagostomy Tube Replacement

Tube only for Esophagostomy Tube Insertion device. One tube.

JOR1083T 15ft x 50cm. Each. \$15.00/ea

BUY NOW

Closed Wound Drainage Kit

This vacuum drain's most common use is for post-op drainage Jackson Pratt. The kit is designed to create suction or negative pressure for draining wounds. A fenestrated silicone drain is placed into position with the aid of a stainless steel trocar. This drain is attached to a silicone bulb with a one-way valve. When the bulb is released a vacuum is created that pulls exudates out through the drain. Wound exudates can be stored, visualized, or cultured. The drain has a radio-opaque line for the entire length.

The kit consists of: a 130mm stainless steel trocar, silicone fenestrated drain and tubing, a silicone bulb and a clamp for attachment to bandage or patient.

BUY NOW

JOR790	Reservoir 100cc, Tubing 1.66mm I.D. x 3.2mm O.D. round, Needle 3.2mm O.D.	\$22.50/ea
JOR790A	Reservoir 200cc, Tubing 2.88mm I.D. x 4.8mm O.D. round, Needle 4.8mm O.D.	\$22.50/ea
JOR790B	Reservoir 100cc, Tubing flat, Needle 3.2mm O.D.	\$22.60/ea
JOR790C	Reservoir 200cc, Tubing flat, Needle 4.8mm O.D.	\$24.00/ea

Flexi-drain Multi-Purpose Wound Drain

A silicone tubular drain that may be trimmed, peeled away, or used as a whole piece for surgical wound drainage. The drain can be split along its length or trimmed to suit individual requirements. Autoclavable. 40cm L drain of 12-3mm dia. catheters.

JORS24G \$7.50/ea

Jorvet

Surgical and Exam Supplies

Laser Replacement Parts & Cold Therapy System

Jorvet Laser Consumable or Replacement Parts

For use with the AccuVet LX-20 CO2 Laser System, JorVet offers these commonly needed parts for the operation of the CO2 Laser. These parts are warranted to be identical in quality to any factory part. All laser tips are compatible with Luxar LXH-ST, LXH-TL, LXH105, and LX-AH Handpieces. Non-sterile.

JOR941B	Ceramic Laser Tip, 10mm x 0.4mm. (Equivalent to the Luxar LXT-010SS metal tip) Offers the ability to do narrower incisions and apply increased power density at higher output than metal. It has a longer life and handles higher power more safely than metal tips. Small spot size. Single tip. One green ring (0.40mm) spot size indication.	\$16.75/ea
JOR941C	Ceramic Laser Tip, 10mm x 0.2mm. (Equivalent to the Luxar LXT-010SS metal tip) Offers the smallest available tip for very fine incisions. Handles 20W power. Extra small spot size. Single tip. Two green ring (0.20mm) spot size indication.	\$16.75/ea
JOR941	Ceramic Laser Tip, 5mm. (Luxar #CS) Shorter tip for tight access applications. 0.8mm spot size. 5/pk.	\$23.00/pk
JOR941A	Ceramic Laser Tip, 10mm. (Luxar #C10) Versatile tip for most applications. 0.8mm spot size. 5/pk.	\$28.50/pk
JOR941X	Laser large spot tip 1.4mm. New larger size for ablation and hemostasis. 1.4mm x 5mm length. Aluminum material.	\$27.50/ea
JOR941P	Gold mirror	\$78.00/ea
JOR941M	Straight Handpiece, Tip securing collet design and ergonomic handle, for less price. (Luxar #LXH-ST, LXH-TL). 5" length.	\$170.00/ea
JOR941N	Angled handpiece, (Luxar #LXH-AH) 105° angle. Improved comfort by design. 5" length	\$181.00/ea

CO2 Laser System Kit



BUY NOW

Includes:

- Straight handpiece (JOR941m)
- Angled handpiece (JOR941n)
- Gold mirror (JOR941p)
- Removal tool
- 3 ceramic laser tips, 5mm x 0.8mm. (JOR941)
- 3 ceramic laser tips, 10mm x 0.8mm. (JOR941a)
- Ceramic laser tip, 10mm x 0.4mm. (JOR941b)
- Ceramic laser tip, 10mm 0.2mm. (JOR941c)

JOR941K \$395.00/ea



BUY NOW



BUY NOW



Jorvet Calf Drencher

Collapsible 2 1/2-liter bag with special rigid probe. 3-track watertight closure aids easy filling. Rigid top portion with holes for easy handling or hanging. On/off flow clamp. Special cold temperature-resistant plastic will not crack. Round ball-shaped end aids proper placement. Graduated markings in both liters and quarts.

JOR138 REORDABLE, EA \$14.40/ea

BUY NOW

Silicone Bulb Evacuators

Silicone Bulb Evacuators Provide Constant, Effective Suction to Help Reduce Occlusion. Designed specifically for smaller procedures where less exudate is anticipated.

DYN/WE1000 Silicone Bulb Evacuator, 400cc Capacity \$18.21/ea
DYN/WE1305 Silicone Bulb Evacuator, 100cc Capacity \$8.05/ea



Complete Cold Therapy System

BUY NOW

The benefits of cold and compression in post-surgical care have long been known. These benefits include minimizing hemarthrosis and swelling. Cold will also reduce postoperative pain. The immediate use after surgical repair of orthopedic procedures such as cruciate or fracture repair is an indication. New surgical procedures such as TPL0 respond nicely to this mode of treatment. The JorVet Portable Cold Therapy System continuously pumps cold water through hoses connected to a soft pad held in place by Velcro straps. Water and ice are put into the cooler reservoir. Temperatures can be set at three ranges to insure therapeutic level of cold:

- Cool: 45-55°F (7-13°C)
- Cold: 40-50°F (4-10°C)
- Colest: 35-45°F (2-7°C)

Features:

- Not gravity dependent, will pump at or below the level of the pad
- Electronic pump is mounted outside the cooler reservoir, not affecting speed of ice melt
- Provides up to 10 hours of continuous and effective cold therapy
- Veterinary specific protocol included

System includes 21" x 11" (31cm x 28.5cm) therapy pad with straps.

JOR923 Weight, with pads 6.25 lbs. (2.84 kg) \$285.00/ea

Therapy Pad

JOR923P 0.25 lbs. (0.12 kg) \$47.60/ea

BUY NOW



Avian Restraint

Auspex Avian Restrainer

Extremely easy to use! Simply fold the flat restrainer to form a truncated cone shape, and rapidly place over the bird. Most birds pop out the smaller opening of the restrainer. The restrainer is indispensable for various treatments, including examinations, administering oral medication or food, injections, working with legs, feet, or clipping nails.



JOR381A	Small. Canaries, budgies, cockatiels	\$8.75/ea
JOR381B	Medium. Conures, small Amazons	\$8.10/ea
JOR381C	Large. Amazons, African greys, and small cockatoos	\$9.60/ea
JOR381D	X-Large. Macaws and moluccan cockatoos	\$14.10/ea
JOR381S	Set of 4	\$37.50/pk

BUY NOW

Jorvet Avian Adhesive Drape

The preferred drape for smaller animals where visualizing your anatomic landmarks is critical. Large enough for cats and small dogs.

Clear plastic material

- 5" x 5" square area of adhesive to adhere to animal
- Individually wrapped in sterile, easy open header pack

JOR259X	44" x 44" 5 pk, sterile	\$26.10/pk
JOR259XS	24" x 24" 5 pk, sterile	\$24.00/pk



Avian Positioner

Auspex Avian Positioner is used to position an avian species for radiography and surgery. The Positioner is made of a piece of durable plexiglass board. There are two short slots and four longer slots machined through the board. Several pieces of strategically-placed velcro hook type fasteners are permanently attached to the bottom of the board. Several straps of loop type velcro are supplied, which are utilized for restraining the bird's and wings. Several pairs of the velcro face straps, used to restrain the bird's legs, are also included. The versatile Auspex Avian Positioner can be applied to most types of birds, from budgerigars to macaws. It is highly effective and reliable, able to securely restrain even the most unruly bird. It is safe and relatively painless, since the bird is held using soft cloth-like straps, unlike the guillotine-type devices that hold the bird's neck down with a piece of hard plastic. The Positioner is low-cost and durable. It is hygienic, easy to clean and sterilize. The wing restraint is a novel feature, useful for radiography. The board has raised feet at the four corners to allow for placement of heating pads under it, when desired. Positioner is low-cost and durable. It is hygienic, easy to clean and sterilize. The wing restraint is a novel feature, useful for radiography. The board has raised feet at the four corners to allow for placement of heating pads under it, when desired.



BUY NOW

JOR381P	18"W x 18"	\$51.00/ea	Jorvet
---------	------------	------------	---------------

Biopsy Embedded Cassettes

Small biopsy samples can get lost in a formalin jar and must be "fished out". These biopsy cassettes hold and contain the sample while it is immersed into a formalin jar. The sample can then be processed at the histopath lab through their automated equipment right in these cassettes. Orange. 50/pk. Needs to be at least a 60ml formalin jar to fit cassette.



BUY NOW

JOR1049	Orange. 50/pk.	\$22.00/ea
---------	----------------	------------

Perivaginal Tape,

To be used according to the Dr. Buhner method for treatment of a prolapse of the uterus or vagina. This special woven oval-shaped tape has histophilic features that permit a heal-in without irritation. Directions for use upon request. 4.5

JOR25	5m.	\$15.70/ea
-------	-----	------------

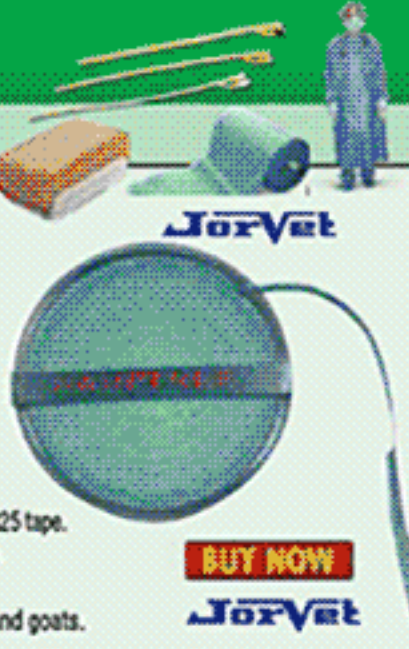

Jorvet



Buhner Needle

For use with JOR25 tape.

JOR26	Stainless steel. 12".	\$21.00/ea
-------	-----------------------	------------

BUY NOW

Gerlach Needle

For use in sheep and goats.

JOR26G	Similar to JOR26, but only 6"L. Similar to JOR26, but only 6"L.	\$17.25/ea
--------	---	------------

Jorvet

OB Shoulder Cuff

Jorvet

Basically the same as JOR29 above, but less area is covered. Very handy in conjunction with disposable or rubber sleeves.

JOR29C	Heat-sealed seams	\$33.00/ea
--------	-------------------	------------

BUY NOW

OB Shoulder Protector

Jorvet

This is the original Danish import, where the arm passes through an opening in the special easy-to-clean rubber shield. There's no bunching of the material in the arm area. If worn in conjunction with a rubber apron, it serves as an OB smock. Protector ties under opposite arm.

JOR29	Heat-sealed seams	\$45.00/ea
-------	-------------------	------------



BUY NOW

See our Scrub & Apparel section for a full listing of OB Rubberized coverings

Jorvet Sterile OB Lube-Vet Label

This small sterile lube packet is great for lubing up a vaginal speculum or anywhere a small amount of sterile lube is required, especially OB work. Non-spermicidal. Easy open 1 oz. packet. 12/case.

JOR781	1 oz., dz.	\$11.40/dz
--------	------------	------------



Jorvet Silicone Wound Drain

Jorvet

Traditional Style 100% Silicone Wound Drains Provide Effective Drainage. Smooth, heat polished perforations are positioned in alternate 90 degree planes for effective exudates drainage. Drain placement is quick and easy thanks to the convenient indicator dot. Available in various round and flat sizes. Radiopaque.

DYNJWE1323A	DRAIN, 15Fr, 3/16, End Perforation	\$7.82/ea
DYNJWE1309	10 mm x 20 cm, 3/4 Perforation, ea	\$8.05/ea
DYNJWE1311	10 mm x 20 cm, 3/4 Perforation, ea	\$8.28/ea
DYNJWE1321A	10Fr, 1/8, End Perforation	\$7.82/ea
DYNJWE1308A	Drain, 7 mm x 20 cm, 3/4 Perforation, ea	\$8.28/ea
DYNJWE1310	7 mm x 20 cm, Full Perforation, ea	\$8.28/ea
DYNJWE1320	7Fr, 3/32", End Perforation	\$7.82/ea
DYNJWE1325A	19Fr, 1/4, End Perforation	\$7.82/ea

BUY NOW

Jorvet Stainless Steel Thoracic Drain

JORS24M	12fr (JORS24c) O.D. 1.3mm I.D. 40cm	\$15.00/ea
JORS24N	14fr (JORS24d) O.D. 2.3mm I.D. 40cm	\$15.00/ea
JORS24P	20fr (JORS24e) O.D. 3.2mm I.D. 40cm	\$16.50/ea
JORS24Q	30fr (JORS24f) O.D. 4.7mm I.D. 40cm	\$18.00/ea

Surgical and Exam Supplies

Safe n' Warm Product & Urine Collection

Jorvet Silicone Thoracic Drain **BUY NOW**

Straight with X-ray opaque line with an open end. Graduated depth markings. Six smooth oval lateral eyes. Autoclavable. 50cm L.

JORS24	16fr. 5.3mm	\$7.20/ea
JORS24A	20fr. 6.7mm	\$7.20/ea
JORS24B	24fr. 8.0mm	\$7.50/ea



Safe 'n Warm Exam Table Mat **Jorvet**

Safe 'n Warm Foam Mat. Post-op patient comfort is simple and easy with these foam padded mats. The core is constructed of thick foam for cushion and comfort. Seamless coating eliminates accumulation of dirt or debris. Totally non-absorbent; allows easy cleaning with standard hospital disinfectants. Just wipe clean with a paper towel. The mat reduces hypothermia, unlike cold stainless steel or metal grate surfaces that drain body heat. Lightweight and portable, can be moved from location to location.

- Fits inside standard cages (i.e., Shor-Line and Suburban)
- Slight bevel tips fluid towards drainage
- Especially valuable for post-op comfort
- Fits on top of wall-mount or pedestal-type exam tables (i.e., Shor-Line and Suburban). Length just short of drain hole.

JOR766 20" x 44" x 1/2" \$238.00/ea **BUY NOW**

Safe 'n Warm Surgery Table Mat **Jorvet**

Safe 'n Warm Foam Mat. Post-op patient comfort is simple and easy with these foam padded mats. The core is constructed of thick foam for cushion and comfort. Seamless coating eliminates accumulation of dirt or debris. Totally non-absorbent; allows easy cleaning with standard hospital disinfectants. Just wipe clean with a paper towel. The mat reduces hypothermia, unlike cold stainless steel or metal grate surfaces that drain body heat. Lightweight and portable, can be moved from location to location.

- Fits inside standard cages (i.e., Shor-Line and Suburban)
- Slight bevel tips fluid towards drainage
- Especially valuable for post-op comfort
- Fits on top of standard stainless steel surgery tables (i.e., Shor-Line and Suburban). Length just short of drain hole.

JOR767	Short. 15" x 40" x 1"	\$210.00/ea
JOR767A	Long. 15" x 50" x 1"	\$276.00/ea

JOR767 & JOR76A

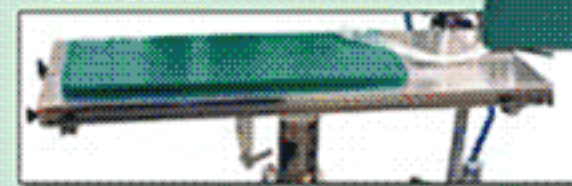

Safe 'n Warm Scrub Sink Mat

Fits on top of standard metal grate style scrub sinks (i.e., Shor-Line or Suburban).

JOR768	Short. 20" x 30" x 1"	\$212.00/ea
JOR768A	Long. 20" x 44" x 1"	\$294.00/ea

BUY NOW



Safe 'n Warm Standing Fatigue Mat

What about the veterinarian or the staff? Long hours of standing on hard floors during surgery or even in the reception area can develop leg and back soreness. These comfortable mats also work for people. Tapered or beveled edges for safety.

JOR769	19" x 38" x 2"	\$372.00/ea
JOR769A	Large. 29" x 38" x 2"	\$490.00/ea



Uro-Collect System **BUY NOW**

The "Uro-Collect" system was developed as an easy-to-use and convenient kit for collecting a noncontaminated and diagnostic urine sample in either the clinic or at the owner's home. 12/pk. Kit includes:

- Litter pan liner
- 4-5 oz. polypropylene beads
- Reclosable bag
- Twist ties
- Complete client instructions

JOR165 Dozen \$67.00/dz



Jorvet Lab Litter **BUY NOW**

FLUTD, or feline lower urinary tract disease, is a common problem in the feline patient. Obtaining high quality urine samples is a must to ensure proper diagnosis and treatment, plus as a follow-up evaluating treatment results. Lab Litter™ is a clear, non-absorbent, small plastic granule that feels like cat litter to the feline patient. It's used to help collect urine samples.

JOR164A Dispensing pack/dozen \$48.00/dz

Lab Litter Beads

JOR165D1 5 Pounds \$60.50/ea



Jorvet Urine Collection Bag

Urine collection bag, smaller version of JOR1027 bag.

- 600ml capacity
- Anti reflux drain
- Bottom drains through twist open/close valve
- Two straps: one on top and one on bottom
- Top drain is filtered to fit catheter i.e. Foley
- Sterile fluid pathway

JOR1027A 600ml \$3.15/ea

BUY NOW



Jorvet Urine Drainage Bag **BUY NOW**

Monitoring urine output is an important aspect in treating critically ill renal patients. These bags are a polyethylene material. They are transparent on one side and the opposite is white.

- 2000ml capacity with graduations
- Inflow connector is a tapered fitting that to a catheter (i.e. Foley) for a secure leak proof fit.
- Tubing is 11/32" X 50" cm length
- Universal double hook: can hang on cage
- Needle free sampling port
- Anti Reflux drip chamber: minimizes the risk of infection
- Additional clip can attach tubing to patients hair or fur
- Sterile fluid pathway

JOR1027 2000ml \$6.00/ea **Jorvet**



Pet, Grooming & Restraints

Restraints - Economy Collars, Saf-T-Clear & Elizabeth

Economy Collar

BUY NOW

Elizabethian-type economy budget collars. Perfect for dogs, cats and other small animals. Lightweight. White opaque polyethylene.



EC7.5	Size 7 1/2	\$2.00/ea	10+\$1.75/ea
EC10	Size 10	\$2.25/ea	10+\$2.00/ea
EC12.5	Size 12 1/2	\$2.46/ea	10+\$2.25/ea
EC15	Size 15	\$2.75/ea	10+\$2.50/ea
EC20	Size 20	\$3.00/ea	10+\$2.75/ea
EC25	Size 25	\$3.50/ea	10+\$3.25/ea
EC30	Size 30	\$4.00/ea	10+\$3.75/ea

Saf-T-Shield Collar

BUY NOW

Saf-T-Shield collar prevents patient from aggravating a healing wound. It was designed for long term clinic/hospital use. This collar is recommended for post-operative protection of ear, eye, abdomen, and foot. Has a easy snap closure and a adjustable fit.



EJ412	12" Diameter, 6" - 8.25" Neck Circumference	\$7.15/ea
EJ412S	12" Diameter, 5.5" - 6.5" Neck Circumference	\$7.15/ea
EJ415	15" Diameter, 6.25" - 8.5" Neck Circumference	\$9.45/ea
EJ418	18" Diameter, 10" - 13.5" Neck Circumference	\$9.89/ea
EJ418S	18" Diameter, 6.5" - 9" Neck Circumference	\$10.62/ea
EJ424	24" Diameter, 10.75" - 14.5" Neck Circumference	\$13.42/ea
EJ424S	24" Diameter, 9.25" - 12.25" Neck Circumference	\$13.42/ea
EJ430	30" Diameter, 13.75" - 18" Neck Circumference	\$16.87/ea
EJ430S	30" Diameter, 11.25" - 15" Neck Circumference	\$16.87/ea
EJ436	36" Diameter, 21" - 27" Neck Circumference	\$24.99/ea
EJ436S	36" Diameter, 13.5" - 18" Neck Circumference	\$22.86/ea

Saf-T-Clear Collar

Made from a clear, durable material providing five neck circumference adjustment point. Allows patient to maintain full peripheral vision. Padded neck area for comfort as is the outside rim. Eight sizes available, from puppies to large breed dogs.



BUY NOW

EJCL625	Clear, 9.25" Width, 15.25"-20" Neck Circumference	\$7.95/ea
EJCL415	Clear, 7" Width, 11.25"-14.75" Neck Circumference	\$5.97/ea
EJCL175	Clear, 3.50" Width, 7"-8.25" Neck Circumference	\$4.31/ea
EJCL210	Clear, 4.50" Width, 7"-9.50" Neck Circumference	\$4.71/ea
EJCL312	Clear, 5" Width, 9.25"-12" Neck Circumference	\$4.87/ea
EJCL520	Clear, 8" Width, 13"-17" Neck Circumference	\$6.74/ea
EJCL840	Clear, 16" Width, 25"-31" Neck Circumference	\$14.88/ea

Recova-Clear Recovery Collar

Ideal for kittens, adult felines & small breed puppies. Patient retains peripheral vision & is resilient enough to allow patient to lie down & sleep. No drawstring.



EJRC3	Clear, Recovery, 8.50" Width, 15"-18" Neck Circumference	\$10.90/ea
EJRC4	Clear, Recovery, Collar, 2 RCX0.3 RCD.3 RC1.1 RC2.1 RC3	\$63.91/ea
EJRC2	Clear, Recovery, 7" Width, 10"-14", Neck Circumference	\$9.55/ea
EJRCX0	Clear, Recovery, 4" Width, 4.50"-7", Neck Circumference	\$4.73/ea
EJRC0	Clear, Recovery, 4" Width, 7.50"-10", Neck Circumference	\$5.31/ea
EJRC1	Clear, Recovery, 6" Width, 9"-12.50", Neck Circumference	\$7.15/ea

Clear Elizabethan Collar

BUY NOW

Comfortable, easy to apply collars made from clear, lightweight, resilient material. Does not impair patients vision. Increased neck circumference adjustment points allows for correct, comfortable fit. Available in 8 sizes to fit small breed dogs up to great danes!



EJCK12.5	9" - 12.5", Neck Circumference, 5" collar depth	\$3.30/ea
EJCK7.5	8.5" - 10.5", Neck Circumference, 3.5" collar depth	\$2.97/ea
EJCK10	8.5" - 10.5", Neck Circumference, 4.375" collar depth	\$3.09/ea
EJCK15	12" - 16", Neck Circumference, 6" collar depth	\$4.29/ea
EJCK20	13.5" - 17", Neck Circumference, 8" collar depth	\$4.62/ea
EJCK25	15" - 19.5", Neck Circumference, 10" collar depth	\$5.61/ea
EJCK30	17" - 22.5", Neck Circumference, 12" collar depth	\$6.27/ea
EJCK40	24" - 31", Neck Circumference, 16" collar depth	\$13.20/ea

Saf-T-Shield Collar

Research Laboratory Animals

BUY NOW



EJRC403V	1.25" Diameter, 2.25" - 3" Neck Circumference	\$4.38/ea
EJRCM	.125" Diameter, 1" - 1.25" Neck Circumference	\$4.38/ea
EJRC404VS	1.50" Diameter, 2.25" - 3" Neck Circumference	\$4.27/ea
EJRC404VL	1.125" Diameter, 3" - 4", Neck Circumference	\$4.38/ea

Flea & Tick Control



See our Pharmaceutical Section



Buster Dog Collar

BUY NOW

Buster disposable protective collars for dogs and cats—an ideal and inexpensive solution.

Material: Made of lightweight flexible plastic. Will not annoy patient during rest since its flexibility will yield to the shape of the head. Endures pushing without getting deformed, even in cold weather.

Application: Easy to fit on the patient. The collar is closed without use of difficult tapes and strings. Its size can be adjusted according to the size of the patient's head, and fastened to the patient's collar by the straps.

Sizes: Available in 8 sizes with adjustments from 7cm to 20cm neckhole. Each collar has 2 to 3 possible adjustments. Each collar has size marked on it. One size 10/pk, or set of 8 sizes.

JOR46A	10 pack, #7.5cm Length, 13" - 15" Opening, 7" - 8" Neck Hole	\$24.20/pk
JOR46B	10 pack, #10cm Length, 15" - 18" Opening, 7" - 8" Neck Hole	\$29.90/pk
JOR46G	10 pack, #12.5cm Length, 18" - 20" Opening, 10" - 12" Neck Hole	\$35.60/pk
JOR46C	10 pack, #15cm Length, 20" - 22" Opening, 10" - 12" Neck Hole	\$39.90/pk
JOR46D	10 pack, #20cm Length, 22" - 24" Opening, 12" - 14" Neck Hole	\$42.75/pk
JOR46E	10 pack, #25cm Length, 24" - 26" Opening, 15" - 17" Neck Hole	\$54.15/pk
JOR46F	10 pack, #30cm Length, 26" - 28" Opening, 17" - 20" Neck Hole	\$62.70/pk
JOR46J	35cm, 10/pk	\$92.00/pk
JOR46S	Set of 7 sizes	\$29.90/set

Stainless Steel Dog Collar Rack

JOR46R With pegs for all seven sizes. Offers a handy way to display the collars as well as store them.

\$118.00/ea

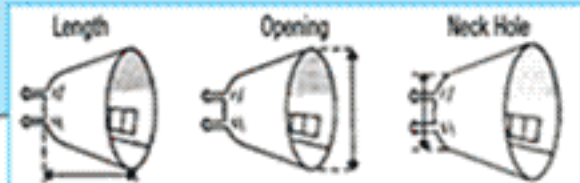
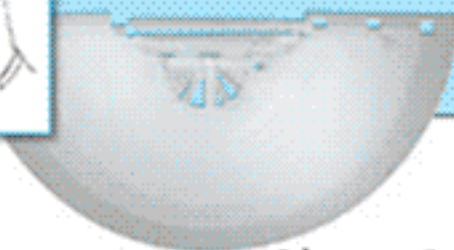

Cervical Collars

BUY NOW

A comfortable & easy-to-use alternative to the Elizabethan collar. Allows pet to eat, drink, sleep, play, run up stairs & around corners & even sit on laps. With these collars, your pet's peripheral vision is unimpeded making them calmer & happier. Collars are made of flexible plastic & are secured by Velcro®, elastic wrap-around strap & harness strap, which wraps around your pet's chest.

EJBF1	2.5" W, 16" Neck Circumference	\$13.01/ea
EJBF2	3.5" W, 18" Neck Circumference	\$13.97/ea
EJBF2A	4" W, 21" Neck Circumference	\$13.12/ea
EJBF3	5" W, 25" Neck Circumference	\$13.63/ea
EJBF4	6" W, 27" Neck Circumference	\$16.21/ea
EJBF5	7" W, 28" Neck Circumference	\$17.30/ea
EJBF6	8" W, 32" Neck Circumference	\$19.11/ea



Clear Collar

BUY NOW

Clearcollar™ Elizabethan Restraint Collars for cats and dogs. These collars have two major features not found in similar products currently available to veterinarians:

- The transparency feature is a substantial advantage for the patient in that it allows peripheral vision. Owners also seem to prefer transparent rather than opaque collars because they are far less conspicuous and appear to be more "humane."
 - The second major feature is a set of small plastic clips designed to make it quick and easy to apply and remove the collar repeatedly. The collar also has three sets of loops for a more secure attachment either by weaving gauze or heavy cord through the loops and tying the ends in a bow, or by tying the loops to the pet's collar.
- Clearcollar™ restraint collars are available in six sizes, and each collar has five sets of adjustment holes to permit proper fitting of most patients. 10/box.

JOR500A	12", 10-pk.	\$62.70/bx
JOR500B	15", 10-pk.	\$68.40/bx
JOR500C	18", 10 pk.	\$71.25/bx
JOR500D	24", 10 pk.	\$91.20/bx
JOR500E	30", 10 pk.	\$112.50/bx
JOR500F	38", 10 pk.	\$139.65/bx
JOR500S	Set of 6	\$68.40/bx



Plastic clips, 20 pk.

JOR500PC \$6.60/ea

Buster Aural Hematoma Pad

BUY NOW

Aural hematomas are a common clinical case. A pocket of blood develops a separation between the inside skin of the ear and the ear cartilage. Surgical treatment is directed towards restoring that skin to cartilage bond.

JOR47 Sterile \$5.10/ea

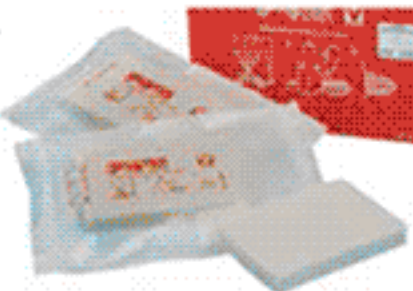



Restraints - Collars & Neck Braces

Plastic Bird Collar

BUY NOW

Clear plastic bird collars. Made of durable plastic material. Easy to assemble and requires only a few staples to secure in place.

JOR46BCA	10 pack, 8 cm	\$13.50/pk
JOR46BCB	10 pack, 10 cm	\$21.00/pk
JOR46BCC	10 pack, 14 cm	\$29.50/pk
JOR46BCD	10 pack, 20 cm	\$37.50/pk
JOR46BCS	Set of 4	\$13.50/set

JorVet

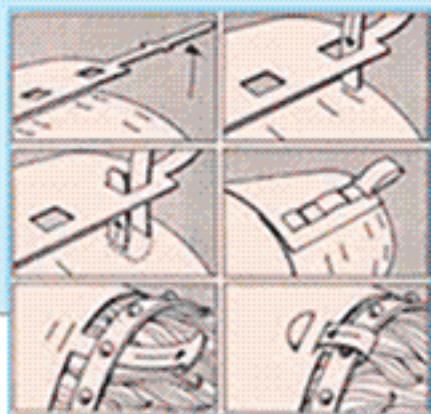

Buster Nylon Basket Muzzle

Clear plastic bird collars. Made of durable plastic material. Easy to assemble and requires only a few staples to secure in place.

BUY NOW



JOR884A	Size #2, Yorkshire Terrier, Papillon, etc.	\$6.00/ea
JOR884B	Size #3, Bichon Frise, etc.	\$8.10/ea
JOR884C	Size #4, Jack Russell, Border Terrier, Whippet, etc.	\$9.00/ea
JOR884D	Size #5, Corji, Fox Terrier, King Charles Spaniel, etc.	\$9.00/ea
JOR884E	Size #6, Beagle, Border Collie, Cocker Spaniel, etc.	\$10.20/ea
JOR884F	Size #7, Dalmation, Springer Spaniel, Samoyed, etc.	\$11.40/ea
JOR884G	Size #8, Airdale, Chow Chow, English Setter, etc.	\$11.70/ea
JOR884H	Size #9, Gordon Setter, Weimaraner, etc.	\$12.30/ea
JOR884J	Size #10, Great Dane, New Foundland, etc.	\$12.60/ea
JOR884M	Size #12 Boxer/Rottweiler, etc.	\$14.70/ea
JOR884S	Set of all	\$104.00/set

Saf-T-Shield Collar Lightweight

Saf-T-Shield collar prevents patient from aggravating a healing wound. It was designed for long term clinic/hospital use. This collar is recommended for post-operative protection of ear, eye, abdomen, and foot. Has a easy snap closure and a adjustable fit.

BUY NOW



EJ408LS	Lightweight, 8" Diameter, 2.75" - 4" Neck Circumference	\$5.77/ea
EJ410LS	Lightweight, 10" Diameter, 3.75" - 5.25" Neck Circumference	\$6.45/ea
EJ406L	Lightweight, 6" Diameter, 3" - 3.25" Neck Circumference	\$5.12/ea
EJ408L	Lightweight, 8" Diameter, 4" - 5" Neck Circumference	\$5.77/ea
EJ410L	Lightweight, 10" Diameter, 5.50" - 7.25" Neck Circumference	\$6.63/ea
EJ412LS	Lightweight, 12" Diameter, 5.25" - 7" Neck Circumference	\$7.35/ea
EJ412L	Lightweight, 12" Diameter, 7.25" - 10" Neck Circumference	\$7.35/ea
EJ406LS	Lightweight, 6" Diameter, 2.50" - 3.25" Neck Circumference	\$5.12/ea

Avian Plexiglass Collar

BUY NOW

Lightweight and rigid protective collar. Clear plexiglass. Uses two set screws (included).

JOR740	3.5cm	\$45.00/ea
JOR740L	4.5cm	\$84.00/ea



Bird Collar

BUY NOW

These bird collars are made of tough, pliable, lightweight material with light-snap fasteners. Neck opening is padded to ensure comfort.

EJ404X	4" Shield Diameter, 1.4" - 2.0" Neck Opening Circumference	\$5.49/ea
EJ406XS	6" Shield Diameter, 2.0" - 2.7" Neck Opening Circumference	\$7.10/ea
EJ406X	6" Shield Diameter, 2.7" - 3.5" Neck Opening Circumference	\$6.59/ea
EJ408XS	8" Shield Diameter, 3.2" - 3.5" Neck Opening Circumference	\$7.45/ea
EJ408X	8" Shield Diameter, 3.5" - 4.0" Neck Opening Circumference	\$7.15/ea
EJ410XS	10" Shield Diameter, 3.5" - 4.0" Neck Opening Circumference	\$8.15/ea
EJ410X	10" Shield Diameter, 4.7" - 5.5" Neck Opening Circumference	\$8.15/ea
EJ412XS	12" Shield Diameter, 4.7" - 5.5" Neck Opening Circumference	\$8.25/ea
EJ412X	12" Shield Diameter, 6.25" - 7.5" Neck Opening Circumference	\$8.95/ea



Pet, Grooming & Restraints

Restraints - Collars; Buster Clic & Soft -E- Collar



Buster Clic Collar

BUY NOW Jorvet

New quick and simple "clic" dosing system. Makes the application of the collar as easy as buttoning your shirt. Fully transparent material, environmentally friendly 100 percent polypropylene. The newly developed material allows the animal all-around vision and animals can avoid walking into furniture, etc. Soft and flexible. Easy to apply to patient. Available in 8 sizes plus combo pack. 10/box.

JOR47A	10 pack, #7.5	\$27.10/pk
JOR47B	10 pack, #10	\$31.35/pk
JOR47C	10 pack, #15	\$39.90/pk
JOR47D	10 pack, #20	\$42.75/pk
JOR47E	10 pack, #25	\$57.00/pk
JOR47F	10 pack, #30	\$62.70/pk
JOR47G	10 pack, #12.5	\$35.60/pk
JOR47H	10 pack, #40	\$139.00/pk
JOR47J	35cm, 10pk	\$126.00/pk
JOR47S	Set of 7, (A-G)	\$31.35/bx



Jorvet Foam Collar

BUY NOW Jorvet

A safe and comfortable support for the neck of dogs and cats. It will also restrict movement of the head, thereby protecting other parts of the body from self-inflicted trauma. The Foam Collar is made from an ultralight, dense and rigid closed-cell foam. The collar is black, with both sides being an easily cleaned "skin". Application of the Foam Collar is simple. It is wrapped around the neck and held in place with one or two pieces of standard adhesive tape. It has no sharp edges, and the ends can be trimmed to an exact custom fit. Six different widths are available to accommodate most dogs and cats. To size for proper fit, measure from just behind the ear to the top bony portion of the shoulder.

JOR610A	3" x 15", 5pk	\$19.50/pk
JOR610B	4" x 18", 5 pk	\$21.00/pk
JOR610C	5" x 21", 5 pk	\$24.00/pk
JOR610D	6" x 24", 5 pk	\$27.00/pk
JOR610E	7" x 28", 5 pk	\$31.50/pk
JOR610F	8" x 32", 5 pk	\$34.50/pk
JOR610S	Set of 6	\$42.00/pk



Jorvet Soft-E-Collar™

Jorvet

BUY NOW

The use of Elizabethan Collars is widespread in veterinary medicine. There have been a multitude of different designs over the years. Traditional "E" collars have tried to balance the comfort of the patient versus the effectiveness of the "E" collar. The Soft-E-Collar™ was designed first and foremost for the comfort of the patient, yet it still is effective in offering licking and chewing protection. Clients like the attractive pattern along with the comfortable foam padding. Pets can move about freely without damaging furniture, and are able to eat and drink more freely than with traditional collars. The Soft-E-Collar™ is a waterproof heavy nylon material that covers a soft foam doughnut-shaped ring. It is held in place by a strong, flat tie.

JOR1003A	XX-small, Weight 2.1, Diameter 8, Center Adjustable 1 7/8", Cat/Dog up to 5 lbs.	\$10.95/ea
JOR1003B	X-small, Weight 2.6, Diameter 9 1/4", Center Adjustable 2 3/4", Cat/Dog 5 - 9 lbs.	\$12.15/ea
JOR1003C	Small, Weight 3.2, Diameter 10 3/4", Center Adjustable 4", Cat/Dog 10 - 14 lbs.	\$12.60/ea
JOR1003D	SS/Medium, Weight 7.0, Diameter 14", Center Adjustable 4 1/2", Cat/Dog 15 - 20 lbs.	\$15.75/ea
JOR1003E	Small/Medium, Weight 7.0, Diameter 16 1/2", Center Adjustable 5", Dog 20 - 30 lbs.	\$18.90/ea
JOR1003F	Medium, Weight 11.3, Diameter 19", Center Adjustable 6", Dog 30 - 55 lbs.	\$22.05/ea
JOR1003G	Large, Weight 14.0, Diameter 23 1/2", Center Adjustable 7 3/4", Dog 55 - 75 lbs.	\$24.90/ea
JOR1003H	X-Large, Weight 19.0, Diameter 27 1/2", Center Adjustable 7 1/4", Cat/Dog 75 - 95 lbs.	\$28.50/ea
JOR1003J	XX-Large, Weight 22.0, Diameter 31 1/2", Center Adjustable 7 1/4", Dog over 90 lbs.	\$31.20/ea
JOR1003S	Set of All 9 sizes	\$165.00/set



Jorvet Leather Muzzle

BUY NOW

Leather Muzzle. High quality, thick-grained leather with heavy-duty rivets. More reliable and safer than canvas or gauze muzzles. Five sizes available for Yorkshire Terriers to Great Danes. One size also especially designed for cats and brachycephalic breeds.

JOR230A	X-Small	\$27.00/ea	JOR230E	X-Large	\$36.00/ea
JOR230B	Small	\$27.75/ea	JOR230F	Brachycephalic and Feline	\$31.75/ea
JOR230C	Medium	\$29.10/ea	JOR230S	Set of 6	\$180.00/ea
JOR230D	Large	\$31.50/ea			



13822 WEST BOULTON BLVD. METTAWA, IL 60045

WWW.SHOPMEDVET.COM

Phone 800-544-7521

138

Fax 800-204-2177

Pet, Grooming & Restraints



Restraints - Muzzles

Nylon Muzzle **BUY NOW**

These high-quality water resistant nylon muzzles come in a variety of sizes and have a quick release snap. An expanded line of quick-release muzzles.

- Safety: Muzzles fit securely with quick-adjust straps for a snug fit.
- Comfort: Lightweight nylon feels and looks more professional than gauze roll.
- Quality: Reinforced stitching to assure long-lasting use.
- MZSET Also sold as a convenient starter set with savings discount: MU0, 1, 2, 3, 4, 4xl, 5, 5xl.

MU0	4", Tiny Dogs, Cavaliers, Yorkies and Mini Poodles	\$4.80/ea
MU1	4.75", Jack Russels, Pugs, Dachshunds, Westies	\$4.80/ea
MU2	5.5", Beagles, Border Collies, Cocker Spaniels, Standard Poodles	\$4.80/ea
MU3	7.25", Bull Terriers, Dobermans, German Shepards, Labradors	\$4.80/ea
MU4	9.5", Large Dogs, Bloodhounds, Danes, St. Bernards	\$4.80/ea
MU5	8.5", Bull Mastiffs, Large Boxers, Rottweilers	\$4.80/ea
MU4XL	11.5", Great Danes, Large Bloodhounds, Large St. Bernards	\$4.80/ea
MU5XL	10.5", For extra large dogs that are listed in size 5	\$4.80/ea
MU6	CAT MUZZLE-REGULAR SIZE	\$4.00/ea
MZSET	Set of 8	\$24.99/ea



Jor-Vet Nylon Muzzle **BUY NOW**

Expanded line of high-quality water resistant nylon muzzles that have a side easy-release snap buckle. Comes in a variety of sizes.

Features:

- Safety: muzzles fit securely with adjusting straps for a snug fit.
- Comfort: lightweight nylon feels and looks more professional than gauze roll.
- Quality: reinforced stitching to assure long-lasting use.

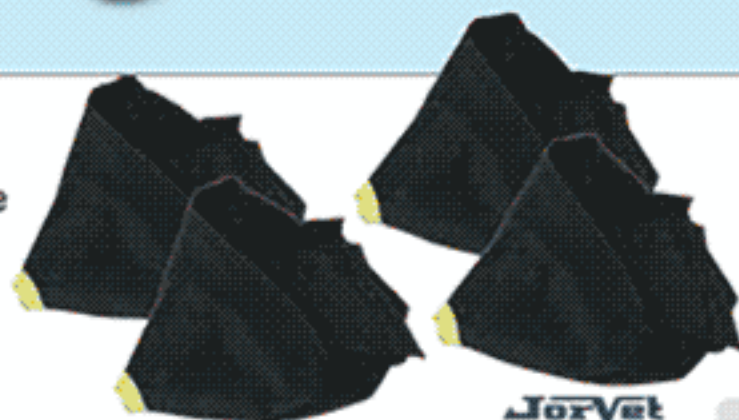

JOR169AA	XX-small	\$5.85/ea
JOR169A	X-Small 4.5" Snout Circumference	\$5.85/ea
JOR169B	Small 5.25" Snout Circumference	\$5.85/ea
JOR169C	Medium 6" Snout Circumference	\$6.05/ea
JOR169D	Large 6.5" Snout Circumference	\$6.05/ea
JOR169E	X-Large	\$6.05/ea
JOR169FT	Set of 3 Feline Muzzles	\$15.00/ea
JOR169FS	Small Cat	\$5.55/ea
JOR169F	Medium Feline 6 + lbs	\$6.45/ea
JOR169FL	Large Cat	\$5.40/ea

JOR169G	Jumbo 10" Snout Circumference	\$6.45/ea
JOR169H	Labrador Retriever, Snout 11.0", Weight 100-120 lbs, Color Green	\$6.45/ea
JOR169JL	Chow, Large	\$6.15/ea
JOR169JM	Chow, Medium	\$6.15/ea
JOR169JS	Chow, Small	\$6.15/ea
JOR169KL	Long Snout, Large	\$6.15/ea
JOR169KM	Long Snout, Medium	\$6.15/ea
JOR169KS	Long Snout, Small	\$6.15/ea
JOR169M	4XL	\$5.70/ea
JOR169N	5XL	\$5.70/ea
JOR169PL	Pug Nose, Large	\$6.15/ea
JOR169PS	Pug Nose, Small	\$6.15/ea
JOR169PT	Set of 2 Pug Faced Muzzles	\$12.75/ea
JOR169Q	Set of 5	\$26.10/set
JOR169R	Set of 7	\$42.75/set
JOR169S	Set (A,B,C,D,E,F,G)	\$39.00/set
JOR169T	Set of 10	\$56.00/set

Nylon Chow Muzzle Set **Jor-Vet**

JOR169JT Set of 3 Chow/Rottweiler Muzzles. \$17.25/set

Nylon Long-Snout Muzzle Set **BUY NOW**

JOR169KS Long Snout, Small \$6.15/ea
 JOR169KT Set of 3 \$17.25/set



Nylon Ferret Muzzle **Jor-Vet**

JOR169X Anyone working at all with ferrets will appreciate this muzzle. \$4.50/ea

Buster Nylon Basket Muzzle **Jor-Vet**

JOR884K Size #11, Boxer, etc. Constructed of strong nylon plastic with a reinforced nose and strong leather strap. Color: tan \$13.50/ea

Pet, Grooming & Restraints

Restraints - Restraint Bags, Door Gates & Ketch All Pole



Jorvet Buster Deluxe Vet Restraint Bag

BUY NOW

The best product out there for restraint!! with these additional features:

- Two carrying nylon straps: ease of transport
- Circular opening over back injection site
- Large velcro flaps over back and smaller for neck
- Faux fur-lined collar for patient comfort
- Four metal heavy-duty zippers: two for front legs and two on back underneath for rear legs
- Rear located velcro flap
- Heavier nylon material that is lined inside with water resistant material
- Color coded for size
- Hanging tab for easy access

JOR1068	Small, Red, <2kg (4.4 lbs)	\$36.00/ea
JOR1068A	Medium, Royal blue, 2-4kg (4.4-9 lbs)	\$54.00/ea
JOR1068B	Large, Green, 4-6kg (9-13 lbs)	\$54.00/ea
JOR1068C	X-Large, Light blue, 6+kg (>13 lbs)	\$57.00/ea
JOR1068D	Set of all four bags	\$176.00/set



Jorvet

McLean Folding Net

BUY NOW

Four feet long when extended with a triangular net opening. This net is ideal for handling cats and other small animals. It works well in corners and folds up to fit in a belt scabbard. The working parts are made of brass, stainless steel and aluminum. The soft 5/8" netting is gentle but strong.

ACE-FN-LXX	15" Long, 20" Across, 21" Deep	\$134.75/ea
------------	--------------------------------	-------------

Nylon Feline Restraint Bags

Jorvet

These nylon bags are designed for proper restraint of fractious cats. They offer 2-way zipper running full length over back for either front or rear access. Comes equipped with a quick-close velcro collar and front leg openings. Pull-tab zipper flap provides quick, fur-free closure. Washable/waterproof.



BUY NOW

JOR170S	Small, 1-5 lbs. Grey.	\$23.10/bg
JOR170	Medium, 5-10 lbs. Navy	\$22.50/bg
JOR170L	Large, 10-15 lbs. Royal Blue.	\$22.20/bg
JOR170M	X-Large, 15 - 25 lbs. Royal Blue	\$22.50/bg
JOR170N	XX-Large, >25 lbs. Royal Blue	\$24.00/bg
JOR170T	Set of 3, Small, medium, large.	\$60.00/pr
JOR170W	Set of 4, Small, medium, large and X-large.	\$90.00/set
JOR170X	Set of 5, Small, Medium, Large, X-Large and XX-Large	\$109.00/set

Jorvet Mesh Cat Restraint Bag

Jorvet

White polyester mesh bag with rear nylon drawstring opening. The end has a canvas collar with velcro closure. Useful for general restraint in examination treatments or grooming. The bag will fit most cats.

JOR172	Mesh	\$9.00/bg
--------	------	-----------

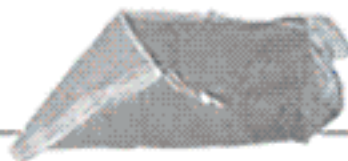

BUY NOW

Freeman Cage Net with Cover

Zipper on bottom of bag for easy access.

ACE-FP-CC	Ideal for animal under 25 lbs. 50" long. Net is 15" across, 30" deep.	\$178.00/ea
-----------	---	-------------



BUY NOW

Jorvet Welbourn Cat Catcher

The Welbourn cat catcher is designed to aid the veterinarian in safe and easy handling of even the most unruly animals. The Welbourn cat catcher is constructed of tough nylon webbing and can be opened or closed quickly as needed.

JOR203	Regular Size	\$65.00/ea
JOR203L	X large with Larger Bag and Longer Pole	\$89.10/ea

BUY NOW



Cat Grasper

BUY NOW

This lightweight grasper was designed primarily for the effective seizure and control of cats. It is ideal for reaching into the back of a cage to secure a difficult cat. The smoothly curved and finished jaws are plasticcovered and designed to minimize discomfort. If necessary, the animal can be quickly released.

JOR141A	30"	\$104.00/ea
---------	-----	-------------

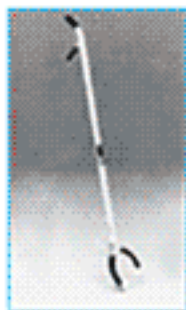

Ketch-All Pole

This is the original "Rabies Stick" for restraint of vicious or hard to control animals. The metal pole has a locking mechanism to hold the cable tight plus a quick release button. Rubber cushion grips for two-handed no slip control. The end of the shaft has a covered portion to protect against chewing.

JOR915	3 ft., Suitable for cats and small dogs. 1 3/4 lbs.	\$110.50/ea
JOR915A	4 ft., The most popular for general use. 2 lbs.	\$122.00/ea
JOR915B	4-6 ft extendable, Telescopes from 4-6 CE when additional length is needed. 2 1/2 lbs.	\$165.00/ea



BUY NOW

13822 WEST BOULTON BLVD. METTAWA, IL 60045

WWW.SHOPMEDVET.COM

Phone 800-544-7521

140

Fax 800-204-2177

Pet, Grooming & Restraints

Restraints - Snarem, Syringe Pole & Restrainer Cage

Snarem Restraint

BUY NOW

The pole is heavy gauge ribbed aluminum tube with a noose that is made of braided plastic coated aircraft cable. The device locks with a slight twist of the hand and both ends move in and out at the same time eliminating noose kinks.

EJS-EM-3	3 Foot	\$44.19/ea
EJS-EM-4	4 Foot	\$55.95/ea
EJS-EM-5	5 Foot	\$54.10/ea
EJS-EM-6	6 Foot	\$60.09/ea
EJS-EM-N	Snarem Replacement Noose	\$17.30/ea

Quick Release Dog Pole

MDC dog poles have been designed to meet the animal control needs of veterinarians. The durable yet lightweight aluminum handle and features a quick-release mechanism.

JOR140B	39"	\$199.00/ea
JOR140C	70"	\$240.00/ea

Jorvet Safety Stick Syringe Pole

This syringe allows you to obtain a proper needle stick, then push the dosage plunger on the operator end. Uses a standard 3cc syringe. Mechanism cannot be damaged by even the most powerful animal bite. Available in 3 different lengths. Easy to inject through cage or from a safe distance.

BUY NOW

Syringe recommended: 3cc disposable syringe.

- Constructed of aircraft aluminum alloy and stainless steel.
- Black anodized satin finish.

JOR482A	3 foot	\$118.00/ea
JOR482C	6 foot	\$170.00/ea
JOR482B	4 foot	\$156.00/ea

5-Way Plastic Door Gate

5-Way Plastic Door Gate is durable and simple to use. Constructed of high impact plastic, this gate can be used in a variety of ways. Can be used as either pressure or swing gate. Mounting hardware included for use as swing gate. Fits doorways 26"-42" wide. Gate is 26" high.

CP78625	26" high	\$39.99/ea
---------	----------	------------

Halti Head Collar

BUY NOW

The Halti was developed over 27 years ago and has been used by over a million dog owners worldwide. The innovative design steers the dog to the side to minimize pulling. It is neck and throat friendly as it doesn't put any pressure on that area. It is eye friendly as the nose band lies well away from the eyes. The slack chin straps allow freedom to pant and the minimal movement of the nose band prevents irritation.

Animal Restrainer Cage

BUY NOW

The MDC Animal Restrainer is suitable for cats or any small animal, and is an effective means for limiting movement in order to administer an injection or effect treatment.

JOR142	11 1/2"W x 17 1/2"L x 11"D.	\$195.00/ea
--------	-----------------------------	-------------

Trap Transfer Restraint

has the added benefit of a facility for transferring the patient from a trap without the need for physical handling. Opening: 10 1/2" x 8".

JOR142T	Overall: 11 1/2"W x 17 1/2"L x 11"D.
---------	--------------------------------------

Tattoo Paste

RXTATTOO-G Green, 5oz

\$14²⁹/ea

BUY NOW



Jorvet

NEW

Tattoo Digits & Numbers

Used for positive permanent livestock identification. Heavy-duty construction. Marker jaws holds four easily interchangeable letters or digits. Digits only go in one way. Positive ear release.

JOR643	Standard Size Digits 0-9	\$9.00/ea
JOR643L	Standard Size Letters A-Z.	\$24.00/ea



BUY NOW



JOR1011A	Size 0, Fits Toy Poodle, Yorkie, Papillon, and other toy breeds	\$9.75/ea
JOR1011B	Size 1, Fits Jack Russell, Daschund, Westie, etc	\$9.60/ea
JOR1011C	Size 2, Fits Beagle, Cocker Spaniel, Schnauzer, etc	\$9.60/ea
JOR1011D	Size 3, Fits Boxer, Labs, Shepherds, Setters, etc	\$9.60/ea
JOR1011E	Size 4, Fits Rottweiler, Mastiff, Newfoundland	\$9.60/ea
JOR1011F	Size 5, St Bernard, Great Dane, Bloodhound	\$9.75/ea
JOR1011S	Introductory display kit. Includes 2 each of the 3 smaller size and 4 each of the 3 larger sizes, plus display head.	\$133.50/ea

Pet, Grooming & Restraints

Pets - Harnesses, Leads & Pillers

Jorvet Halti Harness **BUY NOW** JorVet

The Halti Harness was designed by Dr. Roger Mugford, the creator of the Halti head collar. The Halti Harness has a unique patented front attachment system that controls the dog from his chest and shoulders; an effective point of control. The Halti Harness stops pulling, calms over-boisterous dogs and simplifies training and behavioral therapy. The benefit of a properly used Halti Harness is that it gives total control over the dog's shoulders and thus sets the direction he can move.

JOR1012A	Size Small	\$7.50/ea
JOR1012B	Size Medium	\$8.25/ea
JOR1012C	Size Large	\$10.00/ea



Safety Cat Lead and Harness

The 6 foot lead is made of polypropylene, a completely washable material that will not fray! The lead is fully adjustable and will not slip or bind.

AP-F00400	6'	\$2.80/ea
-----------	----	-----------

BUY NOW



Retriever Retractable Leash

The 'Retriever Retractable Leash' has a belt style leash. The rubber comfort grip gives the unit a high quality look and feel, while the one touch leash lock and durable waterproof construction makes this unit a real buy. Add a safety strobe that can be turned on for night walks, and you have a uniquely superior product.

CP21180	Large, Red, 23ft, 180lb capacity	\$12.52/ea
CP21040	Small, White, 10ft, 40lb capacity	\$8.37/ea
CP21080	Medium, Blue, 16ft, 80lb capacity	\$10.53/ea



Four Paws Nite-Brite Reflective Leash

Nite Brite Leashes make walking your pet safer than ever before with our newly patented, reflective material. Visible from 200 feet, the round braided leashes capture light from any direction.

AP-F55361	3/8" Wide, 6 Feet Long, Black	\$9.37/ea
AP-F55561	5/8" Wide, 6 Feet Long, Black	\$9.90/ea

BUY NOW



Animal Lead **BUY NOW**

Manufactured from braided poly "ski type" rope, these five foot long leads are non-abrasive and have nickel plated rings for strength and reduced friction. Bright two-tone blue and white finish. 12 per package.

EJPEL-SR	5 foot, 12/Pk	\$8.58/pk
----------	---------------	-----------



No-Pull Trainer **BUY NOW**

The No-Pull Trainer is a lightweight device designed to stop all dogs from pulling. It will stop any dog of any size, guaranteed! The trainer is available in three sizes and easy to put on. No collar is required. A trainer that gives you maximum control without choking your dog!

AP-F59325	Small	\$6.48/ea
AP-F59335	Medium	\$7.20/ea
AP-F59345	Large	\$7.20/ea



Pet Piller JorVet **BUY NOW**

Pet Pill Gun used in administering pills to small animals. Unique feature allows a small amount of water to pass with the pill to facilitate swallowing.

JOR67	12/pk.	\$14.40/dz
-------	--------	------------



Pet Piller **BUY NOW**

Long plastic barrel with plastic plunger. Designed like a large animal balling gun. Administer tablets and capsules to pets more quickly, safely, and easily.

- Soft latex rubber tip
- Easy to clean
- Gentle to pet's mouth
- Correct size even for small pets

JorVet



JOR384	12/Bag	\$16.80/bg
JOR384S	Dozen, Carded/individually shrink-wrapped for display. 12/pk.	\$22.20/dzpk

Buster Pet Pillers w/Soft Tips JorVet **BUY NOW**

- New and improved model.
- Finger rings for better control
- Soft rubber jaws to reduce the chance for injury and are more comfortable for the patient
- Can draw water into pet piller to aid swallowing
- Attractive display boxes hold 10 pet pillers
- Transparent barrel

JOR384X	Display Box	\$15.00
---------	-------------	---------



Pet, Grooming & Restraints

Pets - Toys & Chewys



Kong Wubba

BUY NOW

Another great toy from Kong! Fun to tug, fun to toss, fun to say! Small Wubba contains two squeakers. Will the fun ever end? Reinforced Nylon covers this durable, interactive toy. Easy on the mouth and dogs have fun flapping the tails. We think you'll get a kick out of it too! The Small Wubba is 8 1/2 inches long. This is not intended to be a chew toy. Always supervise play sessions.



Wubba.

Wubba Wubba

Easy to pick up and throw. Dogs love the squeaker and long tails!



Water Wubba

Neoprene floats and dries fast for water and snow play. No squeaker.



Snugga Wubba

Soft fleece for gentle indoor play. No squeaker.



The Original Wubba Wubba

WW-10 4" x 17", Assorted Colors \$8.79/ea

Water Wubba

WW-19 4" x 17", Assorted Colors \$8.79/ea

WW-50 3.5" x 13", Water Wubba Junior, No Choice of color \$8.79/ea

Snugga Wubba

WW-29 4" x 17", Assorted Colors \$8.79/ea

KONG WUBBA

E/WP3 Puppy Size \$5.17/ea

E/WB3 Small Size \$3.85/ea

E/WB1 Large Size \$5.45/ea



Perch Tower

Sturdy post and perch combo smothered with plush carpet. A dangling interactive toy guarantees all kinds of befuddling fun. Hours of entertainment for cats and humanoids alike.

CP71921 \$31.50/ea

BUY NOW



Lazy Mouse Laser

The Lazy Mouse Laser projects a mouse image and is safe for all ages. This product is a great exercise item for your pet, includes batteries. FDA Registered and built to last!

CP24300 \$7.25/ea

BUY NOW



Catnip Scratching Post

This scratching post contains organically grown catnip to attract cats and kittens. You can hang it from a doorknob or lay it flat. Let your cats scratch this post instead of your furniture, drapes and rugs.

AP-F01668 each \$4.86/ea

BUY NOW



ODOR CONTROL



SEE OUR PHARMACEUTICAL & STERILIZATION SECTIONS

BUY NOW

Nylabone Puppy Starter Kit

N201PSK 1 Bacon Bone Regular, 1 Durable Chicken Regular, 1 Flexible Puppybone Regular \$4.99/pk

BUY NOW



Plush Vegetable Toy with Squeaker

Give you pet more vegetables, plush vegetables that is! These plush veggies are great attention grabbers for your pets with the bright colors and built in squeaker. Made with bright, durable material, your pet will enjoy its company all the time!

BUY NOW

CP79396 6" Eggplant \$2.30/ea





Jorvet Feline Litter Magnet

An all-natural solution to encourage litter box use. Litter Magnet™ will assist you in treating the most troubling behavioral problem a cat can have, inappropriate elimination, i.e. non-use of the litter box. Often this problem is not medical and cannot be treated with medication. Treatment becomes a consultation with the pet owner, representing time spent for which it is often difficult to be compensated. LitterMagnet™ and its supporting brochure will give you a product that can be prescribed with a tested solution that will help your customer get their cat "back to the box".

An all-natural herbal product, LitterMagnet™, uses its rich earthy fragrance to attract the cat to its litter box. Once the cat goes to the box and finds that it is clean and filled with an appropriate substrate, it will use it and positive behavior modification begins. With LitterMagnet™, you can address a behavior problem and be able to prescribe a solution. You have also made a pet owner happy and possibly kept the cat out of a shelter or from being abandoned.

- LitterMagnet™ (JorVet Product #J1001)
- 20 oz bottle with a shake and pour lid
- Treats 100 pounds or more of clumping/scoopable clay litter
- A client education brochure is provided with each bottle
- 6 bottles per case

BUY NOW



JOR1001 \$10.50/ea

Cookie Nut Ring

A 7" ring of large and small cookies, pecans, almonds, colored wood balls and wheels.

PA33110 10" x 7.5" x 2.75" \$6.93/ea



BUY NOW

Bird Toy Crown

A ring of colored wood, chunks, squares and balls, along with natural rawhide and colored rope. Diameter is 7".

PA33423 1.5" x 6" x 7" \$3.50/ea



BUY NOW

Rainbow Tower of Power

Tight vertical collection of colored wood circles, plastic balls and a dozen rope knots.

PA33537 6" x 16" x 6" \$12.14/ea

BUY NOW



Training Clicker with Wrist Strap

Plastic clicker to be used with the clicker training method. Train your pet humanely and get positive results. Use the fun clicker method to improve your pet's behavior.

CP17700 \$1.60/ea



BUY NOW

Thermo Perch

Protect your exotic birds from harmful effects of air conditioning or cold drafts. Cold is a major detriment to the health of tropical birds. Providing warmth should be the first step in treating any sick bird. Birds lose much of their body heat through their feet. Thermo Perch is made of sturdy scratch and bite resistant plastic. Irregularly shaped, it prevents foot cramps and pressure sores. The perch easily external-mounts to any wire cage, with the cord protected in steel casing. U.L. approved. Patent-pending.

BUY NOW

JorVet

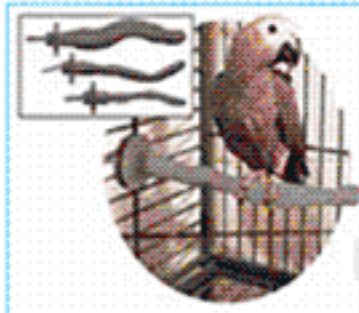

JOR919	Small, 1/2" - 1" dia. x 10 3/4"	\$40.20/ea
JOR919A	Medium, 5/8" - 1 1/4" dia. x 13"	\$58.00/ea
JOR919B	Large, 1 1/4" - 2" dia. x 14 1/2"	\$58.00/ea

Bird Nail & Feather Trimmer

The very small nails of birds require delicate trimming to avoid bleeding or injury. Other trimmers are simply too large to do a proper job. Stainless steel notched blades.

JOR391 10cm L. \$3.30/ea JorVet

BUY NOW



Jorvet Bird Leg Ring Cutter

Aluminum and plastic leg rings frequently prevent venous return from the distal limb of small birds. Edema and necrosis quickly follows unless the ring is removed. Removal of the ring or band without fracturing is not easy without this special cutting tool.

JOR3910 4". \$44.00/ea **BUY NOW**



Hanging Cat Scratcher and Toy

These durable scratching boards also serve as a toy for your cat. Not only do you get a replaceable scratching board, you also get noise making crinkle material inside the arms and legs, a tail with a plastic lattice ball and bell, and a moveable toy on the scratching board. All these things add up to hours of fun for your cat! The board measures 32" long from the top of the hanging rope to the tip of the tail. The actual body size is 22.5" long and 8.5" wide.

BUY NOW

CPCS995 Grey Mouse \$12.99/ea



Rope Toy

BUY NOW

These durable, long-lasting rope toys are sure to please the most finicky of dogs. Made from cotton rope for hours of enjoyment.

CP76111 11" Multi-Color Double Knot \$1.20/ea
CP76017 17" White Double Knot \$6.60/ea



Jorvet Plush Toys

BUY NOW

Durable multi-colored toy is easy to grip for both owner and animal. It comes with attention grabbing squeaker

JOR616E Frisbee \$4.50/ea
JOR616F Football \$3.75/ea
JOR616T T-Tugger \$4.50/ea

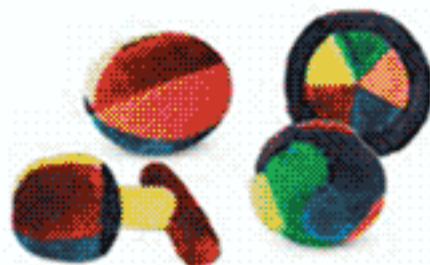

Talking Bone Toy

BUY NOW

The Talking Bone Toy allows you to record a message for your pet and whenever it touches the toy it hears your voice. Great company for your loved one while your out. A fun way to let your pet know you care.

CP22011 \$12.50/ea

NEW



Rawhide Chew-Round Safety Knot

Rawhide Brand Chews are completely natural without chemicals, preservatives or bleaches like other chews. Rawhide Brand Chews are made from natural grass fed beef hides. Patented Round Safety-Knot bone design slows down the chewing process resulting in long-lasting chewing pleasure. Economical pricing and high value as well

PA20700 6" \$2.75/ea

BUY NOW



Vinyl Dog Toy

BUY NOW

Super strong and extra durable Vinyl Toys in colorful, outrageous designs. Each with internal squeaker for more fun. All materials are non-toxic and the squeaker is the safety-type. The vinyl itself is the strongest made.

CPTCR12 Soccer Ball \$4.50/ea



SHOPMEDVET.COM
YOUR ONE STOP VET SHOP!



Nutri Dent Brush Bone

BUY NOW

Unique dental nubs provide 360 degree "all around" cleaning action to help clean teeth, freshen breath and massage gums with every chew!



NTD-101M Medium, 8/pack \$7.60/pk
NTD-102M Large, 4/pack \$7.60/pk

Nutrient Bones

Unique dental nubs provide 360 degree "all around" cleaning action to help clean teeth, freshen breath and massage gums with every chew! Each bone in the tower is individually wrapped!



ND-354 Small Tower, 75 bones \$50.57/ea
ND-356 Large Tower, 25 bones \$45.76/ea

BUY NOW

Dental Stick

BUY NOW

Kong Dental have "Chew Clean" grooves and patented "Denta-Ridges" to reduce plaque and food debris while providing a gentle abrasive cleaning and conditioning of the teeth and gums.

EJKD2 Medium, 15-35 lbs Recommended Dog Size \$5.63/ea
EJKD1 Large, 30-65 lbs Recommended Dog Size \$6.56/ea
EJKD3 Small, 1-20 lbs Recommended Dog Size \$3.73/ea

Greenies

BUY NOW

RXGRP-24 Petite Size, 24/pack \$13.99/pk
RXGRP-14 Regular Size, 12/pack \$13.85/pk
RXGR-8 Large Size, 8/pack \$13.99/pk
RXGRJ-4 Jumbo Size, 4/pack \$13.99/pk



Cat Grass Plus

BUY NOW

Satisfies a Cat's natural craving for grass, helps natural digestion and acts as a natural hairball remedy. Easy to grow, water only once, special water absorbent additive, grass grows straight from the container

RX74670 150gm Tub \$4.50/ea



Blue Kong

BUY NOW

Kong entertains, amuses and occupies pets who are bored, mischievous or suffering from separation anxiety. With tensile strength measuring in excess of 3800 psi, Kong Blue is 25% stronger than Kong toys sold in pet shops. Can be stretched up to nine times its original length and is puncture resistant. Made from nontoxic, nonabrasive and non splintering natural rubber. Now radiopaque.

EJNT3 Small \$4.57/ea
EJNT2 Medium \$6.40/ea
EJNT1 Large \$6.05/ea
EJNTX X-Large \$11.75/ea
EJNTK King Kong \$14.97/ea

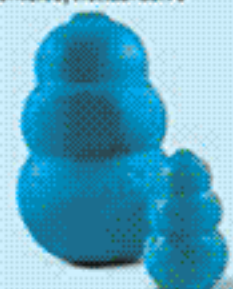

Dental Kong

BUY NOW

A thick, natural rubber provides a real "chewing" workout for any dog. It's beehive design also makes this a great fetching toy that will bounce unpredictably in every direction when thrown. And it floats!

EJDK3 Small with rope \$8.55/ea
EJDK2 Medium with rope \$8.53/ea
EJDK1 Large, No Rope \$10.50/ea
EJDXL X-Large, No rope \$15.08/ea



Kong Stuff'n

BUY NOW

Training treats for positive behavior, low in fat and calories. Natural Liver Treats contains: Beef Liver, Flour, Bran and Water. Natural Lean Treats contain ONLY 3 ingredients, are gluten free, low fat and one calorie a piece. Kong Blue Stuff'N Liver Paste is vitamin enriched, promotes healthy skin and coat. Kong Blue Stuff'N Peanut Butter Paste is specially formulated for dogs.

EJXS1 Kong Blue Stuff'n Liver Paste, 8oz, All Size Dogs \$5.60/ea
EJXS2 Kong Blue Stuff'n Peanut Butter, 8oz, All Size Dogs \$5.60/ea
EJXS2 8 oz. can \$5.60/ea



Ziggies

BUY NOW

Healthy dog treats made for Kong Toys! They freshen breath, clean teeth and are easily digestible!

EJXZ32 Small Puppy, 15-35 LBS. \$11.64/ea
EJXZ22 Medium Puppy, 15-35 LBS. \$11.64/ea
EJXZ12 Large Puppy, 30-75 LBS. \$11.64/ea
EJXZ121 Medium Puppy, 6-20 lbs, Z-Cube 25 pc \$42.90/pk
EJXZ131 Small Puppy, 6-20 lbs, Z-Cube 25 pc \$45.32/pk
EJXZ111 Large Puppy, 30-75 lbs, Z-Cube 25 pc \$43.08/pk



Pet, Grooming & Restraints

Pets - Care Supplies

Disposable Litter Pan

JorVet

Economical, sturdy and disposable, these treated pulp litter pans cost just a few cents each. Stackable for easy storage. Requires only a small amount of litter.

BUY NOW

JOR9768 9" x 12" x 1", 250 per case \$111.00/cs

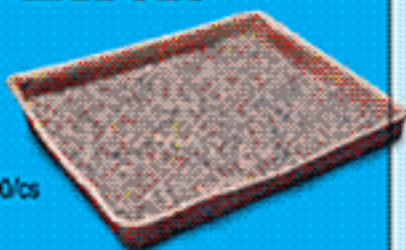

Plastic Disposable/Reusable Litter Pan

Clear plastic for easy cleaning. Higher lip holds in litter better. Recyclable.

BUY NOW

JOR976 9" x 12" x 2 1/2", 100/case. \$175.00



JorVet

Aluminum Disposable/Reusable Litter Pan

This sturdy all-aluminum pan can be reused or recycled. Cleans easily.

JorVet

JOR976A 9" x 12" x 1 1/2", 100/case \$102.00

BUY NOW



Jorvet Lab Litter

Lab Litter™ is a clear, non-absorbent, small plastic granule that feels like cat litter to the feline patient. It is used to help collect urine samples. Bulk container 5 lbs. 4 gallons/case.

JOR164 5 lb container \$45.00/gal

BUY NOW



Wee-Wee Housebreaking Aid

A housebreaking aid specially formulated to help spot train a puppy by encouraging him to eliminate in a place selected by you. Works great with Wee-Wee Pads.

AP-F15000 1oz dropper \$5.12/ea

AP-F15010 8oz pump spray \$5.50/ea



BUY NOW

Kitty-Kab Pet Carrier

This sturdy corrugated carton is great for transporting patients to and from the clinic. This is a nice dispensing item for veterinarians and makes clinic visits more convenient for the client. Shipped flat for easy storage.

JorVet

JOR133 9"W x 11 1/2"H x 18"L \$108.90 when assembled. 20/carton.



BUY NOW

Doggie Doo Bags

BUY NOW

Doggie Doo Bags are biodegradable and come in a convenient, one at a time dispenser box. They're extremely easy to use and pleasantly scented with a baby powder fragrance to mask odors.

AP-F01815 25 bags/box \$2.55/bx

Doggie Doo Bags Refill Roll

Doggie Doo Refill Bags are quick and easy and avoid messy clean ups.

- Made to use with the Four Paws Doggie Doo Dispenser
- Strong and durable
- Leakproof
- Biodegradable bags
- Bag size: 7" L x 12" H

AP-F01814 30 bags \$2.25/ea



Plain Sanitary Pooper Scooper

BUY NOW

Use this scooper for the removal of animal waste pretty much anywhere. The two wrap around scoops are made of aluminum to resist rust. The treated wooden handles also have a hangup loop. Cleaning up after your pet has never been easier!

AP-F18200 32" Height \$10.44/ea



AP-F18200

Rake Sanitary Pooper Scooper

BUY NOW

Designed for quick pick up of animal waste in tall grassy areas. One side of the 7" scoop is solid while the other is a rake. Just as durable and easy to use as the plain scooper.

AP-F18220 32" Height \$10.44/ea



AP-F18220

Deluxe Travel Carrier

BUY NOW

Subtle elegance that allows your pet to travel in style. These deluxe soft carriers come in a classic tapestry design. Front opening for easy exit. Carriers come in two sizes so you can bring your small pet everywhere you go. Both carriers will fit comfortably under airplane seats.

CPLV1 15" Tapestry design \$39.99/ea

CPLV2 18" Tapestry design \$51.99/ea



NEW

Kitty-Kab Pet Carrier

This sturdy corrugated carton is great for transporting patients to and from the clinic. This is a nice dispensing item for veterinarians and makes clinic visits more convenient for the client. Shipped flat for easy storage.

JorVet

JOR133 9"W x 11 1/2"H x 18"L \$108.90 when assembled. 20/carton.



BUY NOW

ITS CLEAN UP TIME!

STOCK UP ON YOUR SHAMPOOS & CONDITIONERS



13822 WEST BOULTON BLVD. METTAWA, IL 60045

WWW.SHOPMEDVET.COM

Phone 800-544-7521

147

Fax 800-204-2177

Pet, Grooming & Restraints

Pets - Bowls & Pet Carriers



Regular Stainless Steel Bowls (A)

Stainless Steel is corrosion resistant, and almost chew-proof. They are heavy-duty for everyday use. Cleans and disinfects easily. They will keep their bright shine and new look, and they are dishwasher safe. Standard shape, no sharp edges. 9-gauge thickness, 6-gauge on larger bowls.

JOR802A	8oz (1/2 pint)	\$2.30/ea
JOR802B	16oz (1 pint)	\$2.85/ea
JOR802C	32oz (1 quart)	\$4.25/ea
JOR802D	64oz (2 quart)	\$4.80/ea
JOR802E	72oz (2.5 quart)	\$5.60/ea
JOR802F	96oz (3 quart)	\$7.35/ea
JOR802G	160oz (5 quart)	\$8.45/ea
JOR802H	240oz (7 1/2 quart)	\$15.20/ea
JOR802J	320oz (10 quart)	\$21.20/ea

BUY NOW



A

Heavy Duty Stainless Steel Bowls (B)

Stainless Steel is corrosion resistant, and almost chew-proof. They are heavy-duty for everyday use. Cleans and disinfects easily. They will keep their bright shine and new look, and they are dishwasher safe. Standard shape, no sharp edges. Gauge is 50-100% thicker than the regular bowls.

JOR803A	16oz (1 pint)	\$5.05/ea
JOR803B	32oz (1 quart)	\$6.45/ea
JOR803C	64oz (2 quart)	\$9.75/ea
JOR803D	96oz (3 quart)	\$13.50/ea
JOR803E	128oz (4 quart)	\$16.05/ea

BUY NOW



B

Non-Tip Stainless Steel Bowls (C)

This heavy-duty bowl features a wide diameter and protective rubber cushion, making it more difficult for animals to tip or knock over the bowl. Less chance for messy water and food spills.

JOR804A	8oz (1/2 pint)	\$4.05/ea
JOR804B	16oz (1 pint)	\$5.55/ea
JOR804C	32oz (1 quart)	\$8.40/ea
JOR804D	64oz (2 quart)	\$9.45/ea

C

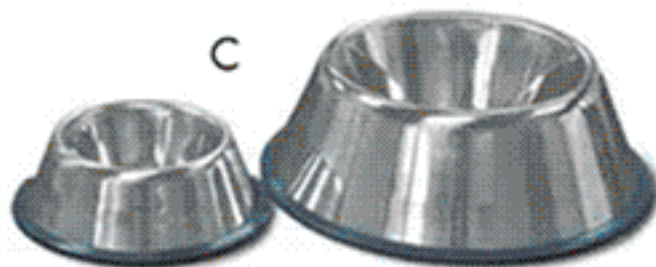

BUY NOW

Pet Carrier

17"L x 12 3/4"H x 8"W

200 lbs test white cardboard

- 17 1/2"L x 12 1/4"H x 8 3/4"W
- Special water based coating provides moisture resistance.
- Safe, no staples, strong glued joints and extra ventilation.
- Recyclable, approximately 70% post-consumer recycled product.
- Printed warning "Do not leave animal(s) unattended in carrier."
- Easy assembly instructions on carriers. Easy one-piece construction.
- Sold by the dozen. **BUY NOW**

PET-C 12/Case \$34.50/cs

Pocket Pet Carrier for Small Animals

- 200 lbs test white cardboard
 - 10"L x 6 3/4"H x 5 1/2"W
 - Special water based coating provides moisture resistance.
 - Safe, no staples, strong glued joints and extra ventilation.
 - Recyclable, approximately 70% post-consumer recycled product.
 - Easy assembly instructions on carriers. Easy one-piece construction.
- Sold by the dozen.

PET-PC 12/Case \$13.75/cs

BUY NOW

**TOP
SELLER**

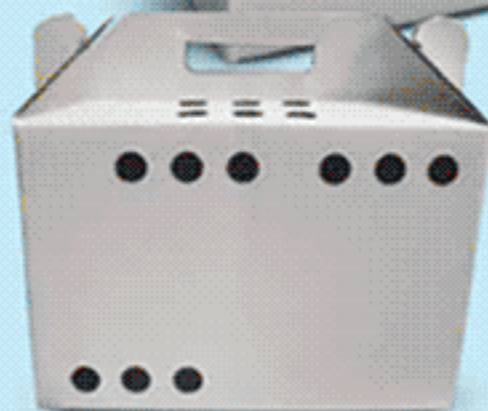

NEW

Pet, Grooming & Restraints

Pets - Cage Liners, Disposable & Reusable Underpads



Economy Weight Disposable Underpads

Disposable Underpads economy weight, light absorbency, feature diamond-embossed fluff-fill to help control fluid leaks. Added embossed polypropylene backing controls slipping to reduce the risk of leaks on patients and bedding.

UPAD1724CS	17" x 24" 300/cs	\$39.00/cs	2+\$35.00/cs	3+\$32.00/cs
UPAD23 24CS	23" x 24" 200/cs	\$39.00/cs	2+\$35.00/cs	3+\$32.00/cs
UPAD2336CS	23" x 36" 150/cs	\$39.00/cs	2+\$35.00/cs	3+\$32.00/cs

Rehab Doggy Diaper Wraps

Rehab Doggy Diaper Wrap

JOR1130A	Small	\$24.99/ea
JOR1130B	Med.	\$26.99/ea
JOR1130C	Large	\$28.99/ea



Doggy Diaper Disposable Pads

JOR1130P	\$13.60/dz
----------	------------

Polymer Underpads

BUY NOW

Eliminate waste with Medline Protection Plus disposable underpads with polymer. These odor-reducing pads lock-in fluids, virtually eliminating the need to stack pads to prevent leaks. Polymer underpads available in deluxe or standard weight. Polymer underpad with wings tucks into the sides of the mattress. Also available are airstream breathable underpads or underpads with wings. Deluxe 36" x 36".

MSC282070LB	36" x 36" 50/case	\$43.17/cs
MSC282050LB	23" x 36" 100/case	\$44.96/cs
MSC282060LB	23" x 36" 75/case	\$39.57/cs

Ultrisorb Underpads

BUY NOW

Ultrisorb wicks moisture away from the patient's skin and is super absorbent to provide optimal skin care. Moisture is pulled away from the skin to provide better skin care and patient comfort. This premium product is cost-effective because just one Ultrisorb absorbs what used to require three or more underpads. 23" x 36" overall, 21" x 32" absorbent core.

MSC282100	23" x 36" 70/case	\$102.13/cs
-----------	-------------------	-------------

Standard Weight Disposable Underpads

BUY NOW

Protection Plus® Disposable Underpads standard weight, moderate absorbency, feature diamond-embossed fluff-fill to help control fluid leaks. Added embossed polypropylene backing controls slipping to reduce the risk of leaks on patients and bedding.

Standard Weight

281245	30" x 30" 150/case Standard Weight	\$51.00/cs
281242	23" x 36" 150/case Standard Weight	\$49.00/cs
281232	23X36 fluff filled Standard Weight	\$49.00/cs
281230	17" x 24" 300/case Standard Weight	\$49.00/cs
281241	23" x 24" 200/case Standard Weight	\$49.00/cs

Deluxe Weight

281260	17" x 24" 300/case Deluxe Weight	\$54.00/cs
281264	23" x 36" 150/case Deluxe Weight	\$53.00/cs



BUY NOW

Disposable Underpads 23 X 36 Super Absorbent 10/pk

The Weekender Premium Disposable Puppy Pads.

- Advanced Supercore thermo-bonded core.
- Wicks moisture away from the surface and locks fluid in within minutes.
- Super absorbent 1 pad absorbs what used to require 3 or more.
- Super strong to reduce tearing and resulting damage to floors.
- Superior odor control.
- Folded over edge for better containment.
- Soft non-woven top sheet across the pad.
- Ultra absorbent polymer is spread throughout the entire core for maximum absorbency.
- Top sheet is fused to the core so it does not bunch up while in use.
- Waterproof polyethylene backing protects underlying surfaces.

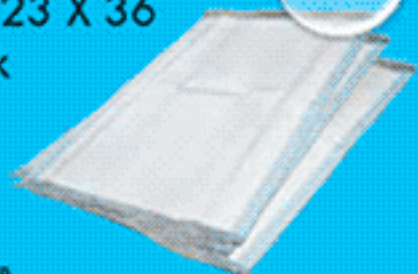

SUPERPAD	23" X 36" super absorbent 10/pk	\$14.00/pk
----------	---------------------------------	------------

Reusable Underpad

BUY NOW

Exactly the same idea as the puppy pads, these reusable no-leak protector pads are great for protecting furniture, car seats, wheelchairs, and bedding! They protect from the staining that occurs from our furry friends accidents, or human incontinence. These reusable no-leak protector pads have a thick top layer which wicks away moisture to a super-absorbent middle layer which also assists in absorbing. What does this mean for you? THE PAD IS ALWAYS DRY, EVEN AFTER AN ACCIDENT! Machine wash and dry as needed as these pads are reusable!!! **Excellent for both pets and humans.**



UPAD-R2436	24" X 36" 1/Each	\$6.99/ea	UPAD-R3436	34" X 36" 1/Each	\$7.99/ea
UPAD-R1824	18" X 24" 1/Each	\$5.99/ea	UPAD-R3442	34" X 42" 1/Each	\$8.99/ea
UPAD-R3448	34" X 48" 1/Each	\$9.99/ea	UPAD-R3036	30" X 36" 1/Each	\$7.29/ea

Pet, Grooming & Restraints

Grooming Supplies - Combs; Pet & Fleas



2 Sided Pet Combs

BUY NOW

2-sided combs with plastic handle with stainless steel comb.

CPB1026 Pearl Color Handle \$8.99/ea



Greyhound-style Pet Combs

BUY NOW

Greyhound-style stainless steel combs.



CPB1041 Greyhound Medium/Coarse \$10.05/ea

CPB1042 Greyhound Fine/Medium \$9.50/ea

CPH075 Greyhound Med/Coarse \$10.50/ea

Round Back Pet Combs

BUY NOW

Round back comb with plastic handle with stainless steel comb.



CPB1004 Fine Stainless Steel Teeth \$5.00/ea

CPB1005 Medium Stainless Steel Teeth \$5.00/ea

CPB1006 Coarse Stainless Steel Teeth \$9.50/ea

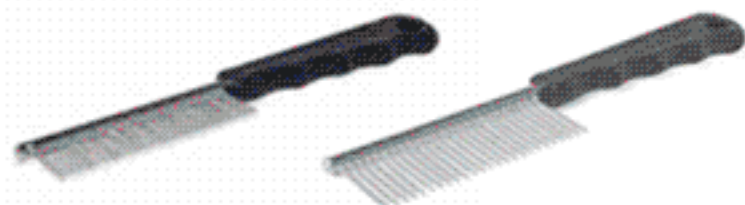

Deluxe Flea Comb

BUY NOW

Extra-Fine Comb has 36 stainless steel teeth per inch. Comfortable nylon handle, convenient small hanging ring in handle. 12/pk.

JorVet

JOR321A Extra Fine Teeth, 12 pk. \$45.00/pk



Cat Flea Comb

BUY NOW

High impact plastic handle, surgical stainless steel teeth, 36 teeth per inch.



EJFK3 32 Teeth per inch, Surgical Steel, molded arch \$3.85/ea

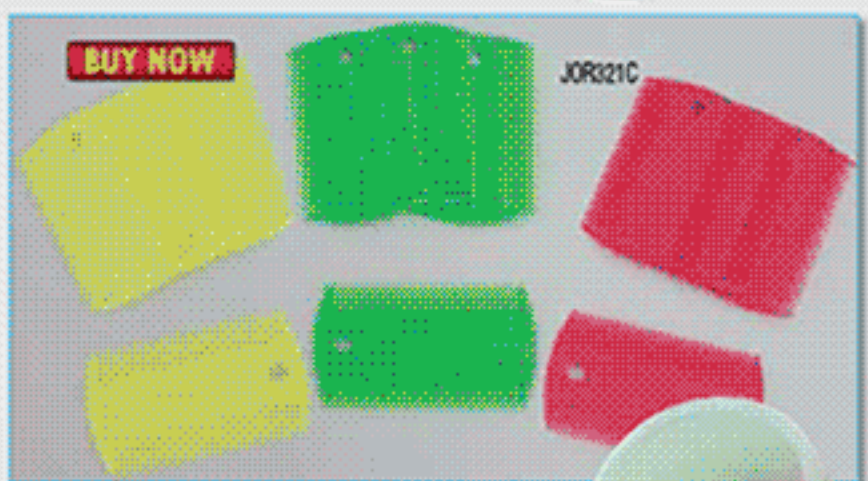

BUY NOW

JOR321C

Colored Flea Combs

Assorted Colored Flea Combs. 72 combs in 4 neon colors in a convenient display jar.

JorVet

JOR321C Disposable, 12pk. \$7.20/dz
JOR321D Colored, 72 in jar \$41.40/ea
JOR321E Combs only \$36.00/ea



Flea Comb Refill

Flea control combs, high quality. Rakes and combs are professional grade.



BUY NOW

EJFK2WR Flea Comb Refill, Nylon, 72 Combs, White \$50.08/cs
EJFK2MR Flea Comb Refill, Nylon, 72 Combs, Mixed Colors \$50.08/cs

Flea Combs Dispenser

EJFK2D EMPTY COUNTER TOP DISPLAY \$4.87/ea
EJFK2MD 100 Combs, Mixed Colors \$69.55/cs



Pet Fleakom

BUY NOW

Designed and manufactured to withstand hard professional use, these fleakoms have individually placed teeth set firmly into a heavy metal cap which fits over a durable hardwood handle. The "English Type" tapered and rounded teeth are designed to glide through an animal's hair and are pointed enough to penetrate a badly matted coat. These professional grooming tools have the teeth properly spaced to permit grooming with ease.

EJFK-1 Wood-Handle all purpose \$5.12/ea
EJFK-2 Nylon, 3 1/2" \$0.78/ea



English Flea Comb

English Pattern Flea Comb. 22 stainless steel teeth per inch. Blue nylon handle. 12/pk.

JorVet

JOR321B English Pattern, 12 pk. \$57.00/dz



BUY NOW





Pet Dematter

Quality grooming products from Groomaster. Featuring stainless steel dematters with saw-edge blades. Comes with your choice of a heavy-duty hardwood handle or nylon non-slip handles. Most blades can be sharpened or replaced.

BUY NOW



CP93001	12 Blade	\$7.00/ea
CP94002	Extra Blades for 12 blade	\$2.50/ea
CP40290	Wood Handle, 9 Blade	\$5.75/ea
CPK1R	9 Blade Replacement	\$2.75/ea
CPK93001	9 Blade Plastic Handle	\$4.50/ea
CPK94001	10 Blade Rake	\$5.75/ea

Ultimate Touch Professional Mat Removing Comb

Remove mats with ease using the Professional Mat Removing Comb. The Ultimate Touch grooming line offers high impact molded hardware with rubber accents at sensitive pressure zones.

AP-F11103 \$15.99/ea

BUY NOW



Dematting Comb JorVet

Sharp, serrated blades cut through tough mats quickly. Nylon handle. The best way to work through the most challenging cases.

JOR379 \$7.35/ea

BUY NOW

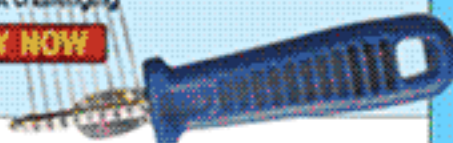

Tender Touch Slicker Wire Brush

These brushes are manufactured with strong wooden handles, stainless steel pins, and reinforced rubber pods allowing all animals to be brushed with a tender touch.

AP-F00340	for cats	\$5.25/ea
AP-F00345	for puppies	\$5.25/ea
AP-F00347	for rabbits	\$4.78/ea



Pet Slicker **BUY NOW**

Quality grooming products from Groomaster. These slickers feature stainless steel pins, which goes through hair much easier. Comes with your choice of wood or plastic handles.

CP133 Sensitive Area Triangle, Wood Handle \$5.50/ea

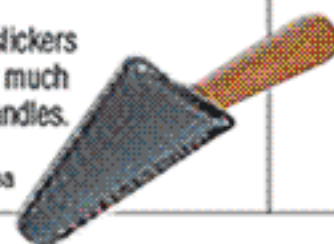

Ultimate Touch Shed 'N Blade

The Shed 'N Blade will protect your home and furniture from pet's excess shedding. It is designed to remove all dead and unwanted hair from your pet leaving him with a lustrous and healthy looking coat. Used by professional groomers and handlers.

AP-F11050	Small	\$8.99/ea
AP-F11051	Large	\$9.99/ea

BUY NOW



Jorvet Shedder Blade w/Leather Strap

Shedding blade with fine teeth on one side and coarse teeth on the reverse side. Leather strap. The shedding blade is very useful in removing dead and matted fur from thick and heavy undercoats. Packaged in poly bag with attractive header.

JOR607 \$5.75/ea

BUY NOW



Pet Shedder **BUY NOW**

These stainless steel shedders are wonderful for not only your companion animals, but the larger model works great on larger animals as well...such as horses.

CP11	Small	\$4.00/ea
CP12	Single Circle Medium	\$7.75/ea
CP13	Single Circle Large	\$8.00/ea
CP8	Double Circle Wood Handle	\$5.04/ea



Jorvet Slickerbrush®

The slicker brush does a great job when removing a large amount of hair that a regular comb simply will not pick up and hold. Comes complete with small cleaning comb that removes hair from slicker. Stainless steel back and pins. Plastic handle.

JOR376 5 1/4" \$5.40/ea

BUY NOW

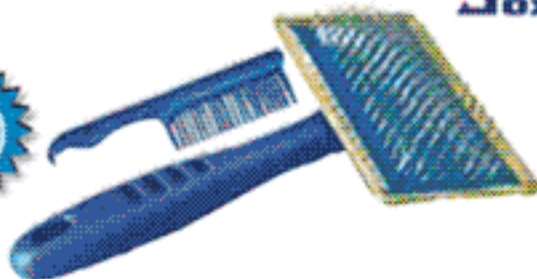

JorVet

Pet, Grooming & Restraints

Grooming - Gloves, Brushes & Furminator



Cat Grooming Gloves

Most cats enjoy being petted, however, grooming with a stiff comb is often stressful. These white grooming gloves have raised blue dots on both sides that catch loose hair while simply stroking the hair coat. The gloves are 60 percent polyester and 40 percent cotton. Washable. One size fits all. Packaged one pair per poly bag with an attractive header.



JOR603 \$3.75/ea

JorVet

BUY NOW

Hand Brush

BUY NOW

Large oval brush with hand strap. Stiffer bristles stimulate coat and skin. Can be used as an invigorating shampoo brush.



CP1065L With hand strap, Stiff Bristles \$3.30/ea

Combo Grooming Brush **JorVet**

This comb and brush has one side with metal pins for removing excess hair and tangles. There are over 120 wire teeth held by a flexible rubber base. The other side is nylon bristle comb that smooths out the hair coat. Attractive dark-varnished wood handle.

BUY NOW

JOR604 \$4.50/ea



Pet Brushes

BUY NOW

Quality grooming products from Groomaster. These brushes are manufactured from hardwood, not compositions or softwood. All pins are smooth, round, bubble-tip and are rust resistant. Bristles are generously and evenly cut nylon, polypropylene or pure boar bristle. Boar Bristles are soft and will not damage even the most delicate coats.



CP5207	Small Oval Bristles	\$1.75/ea
CP5207B	Small Brush, Boar Bristles	\$2.43/ea
CP5208	Medium Brush, Bristles	\$2.80/ea
CP5208B	Medium Brush, Boar Bristles	\$2.38/ea
CP5209	Large Brush, Bristles	\$2.38/ea
CP5209B	Large Oval Brush, Boar Bristles	\$2.58/ea
CP5211	Small Brush, Bubble-Tip Pins	\$2.22/ea
CP5495	Medium Brush, Bubble-Tip Pins	\$2.50/ea
CP5497	Large Brush, Bubble-Tip Pins	\$2.75/ea

ANIMAL HANDLING GLOVES SEE OUR GLOVES SECTION FOR A FULL SELECTION



Furminator Deshedding Shampoo

- Promotes a healthier skin and coat to reduce excess shedding
- Enriched with Omega 3 and 6 Fatty Acids plus other vitamins and proteins to help promote healthier skin, a shiny topcoat, and reduce excessive shedding
- Non-irritating, non-drying hypoallergenic formulation
- Works great on all shedding, long and short-haired dogs and cats
- Fresh, clean scent
- Used and recommended by Veterinarians and Professional Groomers worldwide

FUR013 Deshedding Shampoo, 16oz

BUY NOW

\$8.95/bt

Furminator

BUY NOW

Revolutionary grooming tool! Quickly and easily removes the undercoat and loose hair without damaging the topcoat. Reduces shedding up to 90%!! Guaranteed to reduce shedding better than any brush, comb or rake. Works great on all shedding dogs and cats--long and short-haired. Brings out the pet's natural oils, promoting healthy skin and a shiny coat. Reduces the amount of airborne elements that cause allergic reactions in many people.

FUR01023	Double edge, 2.65"	\$49.99/ea
FUR003	Yellow, Medium, 2.65" Edge	\$44.99/ea
FUR01012	Furejector 2.65" Edge, Ejector button	\$49.99/ea
FUR004	Yellow, Large, 4" Edge	\$54.99/ea
FUR01037	Green, Equine, 5" Edge	\$54.99/ea



NEW

Grooming - Rakes, Trimmers & Files



Pet Rake

BUY NOW

Quality grooming products from Groomaster. Designed to remove undercoat and leave the top hair undisturbed. Designed with longer teeth for penetration. All rakes have Tefloncoated steel teeth, except for Item #CPB2009.

CPB2009	Utility, 2 Row	\$3.75/ea
CPJC91	Undercoat, Regular	\$3.75/ea
CPJC91M	Undercoat, Mini	\$3.25/ea
CPJC92	Undercoat, Long Tooth	\$4.00/ea
CPJC92M	Undercoat, Mini Long Tooth	\$3.75/ea
CPK90001	Undercoat, Short Tooth	\$3.25/ea
CPK90002	Undercoat, Long Tooth	\$4.25/ea
CPB1021	Medium, Wood Handle	\$5.50/ea
CPB1022	Coarse, Wood Handle	\$5.00/ea
CPB1023	Molting, Wood Handle	\$6.00/ea



Wood Pet Rake

BUY NOW

Designed and manufactured to withstand hard professional use. The "English Type" tapered and rounded teeth are designed to glide through an animal's hair and are pointed enough to penetrate a badly matted coat. These professional grooming tools have the teeth properly spaced to permit grooming with ease.

EJR1	12 Teeth, one-bank	\$5.20/ea
EJR2	23 Teeth, two-bank	\$6.88/ea
EJR3	35 Teeth, three-bank	\$7.29/ea



E-Z Nail Clipper and Filer

NEW

Trim the nail with the clipper and smooth the rough edges with the rotary filer. Comes with an extra grinding stone and charger. It's the safe and easy way to trim nails!

5960 \$21.95/ea



Nail Clippers

BUY NOW



CPN01	6", Pliers-Type	\$4.50/ea
CPN02	4.5", Sm Animal	\$2.50/ea
CPN03	Guillotine-Style	\$3.00/ea
CPN04	Cat/Kitten	\$2.75/ea
CPN06	5", Pliers-Type	\$3.50/ea
CPN011	Heavy Duty Pliers-Type	\$3.95/ea
CPN03R	3/Pk Blades Guillotine-Style	\$2.50/pk

Undercoat Rake

BUY NOW

Undercoat Rake with two rows of teeth. The extra row of teeth allows this rake to really get at removing clumps of dead and matted hair. Chrome-plated teeth avoid buildup of static in hair. Any dog with a heavy undercoat needs this rake. "T"-shaped non-slip blue handle. Packaged in attractive blister package.

JOR612	2 rows of teeth	\$4.80/ea
--------	-----------------	-----------

Designed to remove hair from the dense undercoat. One row of teeth in a T-shaped design. Attractive. Tefloncoated teeth with nylon handle.

JOR378	\$5.25/ea
--------	-----------

JorVet



Nail File (2-sided)

JorVet

This nail file helps eliminates concerns of cutting nails too short or into nail quick. The nail is first cut with a trimmer then filed down to desired length.

- Rounded concave surface. The inside coarse blade shortens nail length, while the outside fine blade smoothens nail
- Blue non-slip handle
- Packaged in attractive blister pack for display

JOR602	6"L.	\$2.70/ea
--------	------	-----------

BUY NOW



Nail File

BUY NOW

Also available, a double-sided nail file for filing down nails after clipping.

CPN013	Nail Double Sided	\$2.25/ea
--------	-------------------	-----------



SAVE ON YOUR GROOMING SUPPLIES!

Pet, Grooming & Restraints

Grooming Supplies - Clippers

Km2 Clipper

Special features designed for durability, ergonomically Shaped for Comfortable Use Includes Competition Series Blade Set! Detachable Blade Premium Quality Precision Ground High Carbon Steel Blade. Kit Includes - Clipper w/16 foot professional grounded power cord, competition series size #10 (1/16" 1.8mm) detachable blade set, #40 Set (9575-800, only), cleaning brush, lubricating oil.

Features:

- Cool Running
- Quiet
- Fast
- Lightweight

9757-300 Km2 2 Speed, includes #10 Blade \$147.45/ea

9757-800 Km2, 2 Speed, includes #40 Blade \$147.45/ea

**BUY NOW**

Bravura Clipper

80 minutes of battery operation. Includes: cord/cordless clipper, charging storage base, detachable blade set w/5 adjustable sizes from #9 to #40, four snap-on guide combs, cleaning brush, clipper oil, blade guard & instructions.

41870-0430A Bravura \$176.55/ea

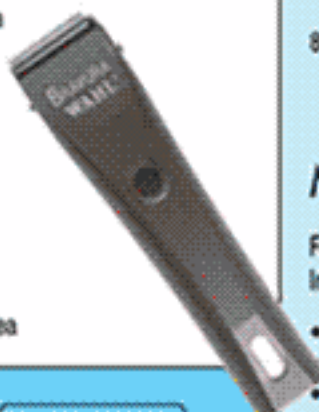

Super Pocket Pro Clipper

WAHL®

Pocket Pro Compact Trimmer Quiet, Lightweight Palm size trimmer. Compact and contoured for easy handling.

Includes:

- Oil
- 2 trimming attachment guides
- Blade guard
- 1 AA alkaline battery and instructions.

9961-2001 \$22.65/ea

**BUY NOW**

Stylique Clipper

Slim pencil shape and narrow blade design for accuracy and precision. Available in blue. Great for trimming face, ears & paws.

Includes:

- Trimmer with built in cleaning brush
- 1 AA alkaline battery
- Blade guard
- Oil and instructions

9951-601 Stylique \$18.15/ea

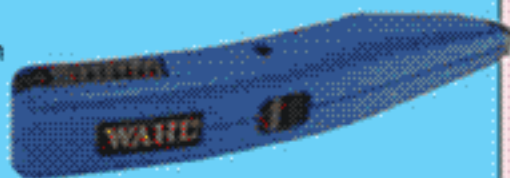

Clipper, Touch Up Trimer Kit

9990-602 \$23.65/ea

BUY NOW

Arco Clipper

BUY NOW

- Professional Cordless Rotary Motor Gear Driven
- Powerful 5500 Strokes per Minute
- Lightweight
- Made in Germany
- Quiet
- Cool Running, No Spray Coolant Needed
- Hard Chrome Blade Finish Resists Rust & Corrosion

This Kit Includes - Professional cordless clipper/trimmer with indicator light - Precision ground high carbon steel detachable blades, fully adjustable to five cutting positions from #10-#40 - Two drop-in Ni-Cad rechargeable battery packs - Charging base with indicator light - Four snap on guide combs - Cleaning brush - Lubricating oil - Blade guard - Instructions

8786-550 Arco SE \$145.95/ea

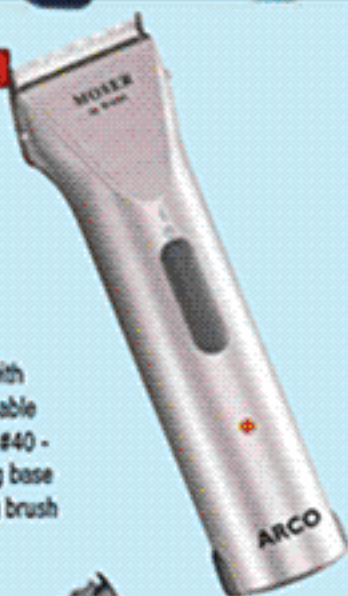

Mini Arco Clipper

BUY NOW

Features a superior quick detachable blade set. Includes:

- Cord/cordless trimmer
- Charger
- Detachable #30 blade set
- Cleaning brush
- Oil
- Two snap-on guide combs
- Instruction on use

8787-1550 Mini Arco \$82.95/ea



Arco SE Pink



Professional Cordless Rotary Motor Gear Driven
Powerful 5500 Strokes per Minute

- Lightweight
- Made in Germany
- Quiet

Cool Running, No Spray Coolant Needed
Hard Chrome Blade Finish Resists Rust & Corrosion
This Kit Includes - Professional cordless clipper/trimmer with indicator light - Precision ground high carbon steel detachable blades, fully adjustable to five cutting positions from #10-#40 - Two drop-in Ni-Cad rechargeable battery packs - Charging base with indicator light - Four snap on guide combs - Cleaning brush - Lubricating oil - Blade guard - Instructions

8786-600 \$145.95/ea



Tough enough to wear pink

Grooming Supplies - Clippers, Blades & Accessories



WAHL®

BUY NOW

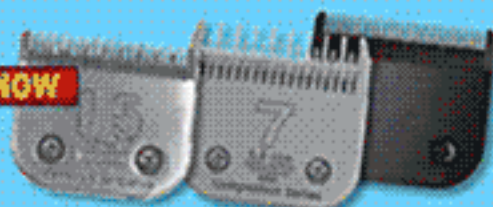

Clipper Blades

#4F-2375	#4 Full, Extra Coarse, Cut Length of 8mm	\$32.35/ea
#3F-2376	#3 Full, Extra Coarse, Cut Length of 10mm	\$34.45/ea
#10-2358	#10 Medium, cut length of 1.8mm	\$24.45/ea
#15-2357	#15 Medium-Fine, cut length of 1.5mm	\$24.45/ea
#30-2355	#30 Fine, cut length of .8mm	\$24.45/ea
#40-2352	#40 Surgical, Cut Length of .6mm	\$24.45/ea
#50-2350	#50 Ultra Surgical, Cut Length of .4mm	\$24.45/ea
#5-2371	#5 Skip, Cut Length of 6mm	\$31.15/ea
#5F-2372	#5 Full, Coarse, Cut Length of 6mm	\$31.15/ea
#7-2367	#7 Skip, Cut Length of 3.8mm	\$30.15/ea
#7F-2368	#7 Full, Medium Coarse, cut length of 3.8mm	\$30.15/ea
#8.5-2362	#8.5 Medium, Cut Length of 3mm	\$25.65/ea
#9-2360	#9 Medium, Cut Length of 2mm	\$25.65/ea

Mini Blade

BUY NOW

2179-100 Each \$26.75/ea



Bravura Blade

BUY NOW

2179-301 Each \$29.75/ea



Andis Clipper Blade

AN15 #15 Medium/Close

\$31.99/ea

BUY NOW



Pocket Blade

Pocket Pro Replacement

1001 #40 fine blade for pocket pro

BUY NOW

\$13.95/ea



Oster Kool Lube 3®

BUY NOW

Kool Lube 3 is a quick, effective lubricant that provides instant cooling, lubrication, and cleaning for your clipper blades. Simply spray Kool Lube 3 through the clipper blades occasionally during the time you are clipping for reduced friction, heat, and less blade wear without a heavy residue of oil.

OSTER-KOOL Cleaner, Lubricant, Coolant \$9.50/ea



Clipper Blade Oil

BUY NOW

The standard in the clipper cutting industry. One drop of wahl oil after each cut translates into a long blade life.

3310 4oz \$3.35/ea



Wahl Ultimate Blades

Wahl Animal Division introduces the latest addition to its professional grooming products, the "Ultimate" Line of Competition Series Blades. Now professionals can cut their clipping time in half with smoother feeding and faster cutting ability with the New "Ultimate" Competition Series Blades. The Competition Series - "Ultimate" Blades have every characteristic a professional looks for in a USA quality manufactured blade.

The new "Ultimate" Line of blades feature a variety of improvements including:

- Upgraded tooth geometry for higher performance
- High performance blade cuts 2.5's faster (than Wahl Competition Series Blades)
- Smooth feeding leaves no clipper tracks
- Midnight color for easy reference
- Fits most standard detachable blade clippers
- New innovative packaging
- New 6 pack overpack

BUY NOW



Ultimate Competition Blades

2372-500	#5F Full Coarse	\$39.55/ea
2360-500	#9 Medium	\$32.55/ea
2367-500	#7 Skip Medium Coarse	\$36.95/ea
2368-500	#7F Full Medium Coarse	\$36.95/ea
2370-500	#5WF Full Coarse Wide	\$42.95/ea
2362-500	#8.5	\$32.55/ea
2371-500	#5 Skip Coarse	\$39.55/ea
2374-500	#4 Skip Extra Coarse	\$42.95/ea
2375-500	#4F Full Extra Coarse	\$42.95/ea
2376-500	#3 Full Coarse	\$46.75/ea
2377-500	#10W Extra Wide	\$39.55/ea
2450-500	X-Blend	\$56.75/ea
2430-500	X-Block	\$56.75/ea

Wahl Ultra Surgical Ultimate Blades

2358-2101	#10 Medium	\$30.95/ea
2355-2101	#30 Fine	\$30.95/ea
2350-2101	#50	\$30.95/ea
2352-2101	#40	\$30.95/ea
2357-2101	#15 Medium	\$30.95/ea

Clipper Cleaner

BUY NOW

Refillable pump spray bottle. Easily cleans and disinfects you clipper blades with one easy spray.

3701	8oz	\$11.35/ea
3701-300	24oz Refill	\$20.55/ea



Oster Blade Wash

BUY NOW

Sharp move using Blade Wash® to clean your blades. It easily flushes away hair that accumulates on blades and is also superb for lubricating blades and removing factory-applied preservatives.

OSTER-WASH \$7.32/ea



Clipper Holder

BUY NOW

Conveniently keeps clipper within easy reach and protects blade and clipper from damage. Can be installed at your station or work area. Easy install.

PL300 Plastic \$18.00/ea



Pet, Grooming & Restraints

Grooming - Clippers, Nail Trimmers & Pet Care

Cat Claw Clipper

This clipper is manufactured with surgical steel to give the cat or kitten's nail a clean sharp cut.

AP-F00455 \$4.96/ea

BUY NOW



Safety Pet Nail Clipper

This nail clipper can be used on dogs, cats, birds and other household pets. It has a safety bar to prevent over-cutting and the blade is guaranteed for three years against dulling.

AP-F00463 \$4.96/ea

BUY NOW



Nail Trimmer for Dogs

These trimmers have been designed with stainless steel surgical blades which offer many years of sharp, clean cutting.

AP-F00401 Small and Medium Breeds \$6.99/ea

AP-F00452 Large Breeds \$6.99/ea

BUY NOW



Resco Nail Trimmer

Regular or jumbo nail trimmer. Replacement blades fit both trimmers.

727 Regular \$8.49/ea

747 Jumbo \$8.75/ea



Guillotine Style Nail Trimmer

JOR307D1 Spare Blade \$0.90/ea

JOR307 5"L \$5.70/ea

JorVet BUY NOW



Super Nail Clipper

This nail clipper was designed especially for large breed dogs. It has a larger cutting blade that is guaranteed against dulling for three years. This clipper is recommended by veterinarians, groomers and professional handlers.

AP-F00464 For large breed dogs \$11.26/ea

BUY NOW



Super Mini Nail Clipper

AP-F00465 with Safety Bar \$7.48/ea

BUY NOW

Cat Nail Clipper

Cat Claw Scissors especially designed for cutting the thin and fragile nails of cats and small exotics. Gives a good clean cut without tearing or shredding.

JOR84C Stainless Steel, 3" (7.5cm) \$6.00/ea

BUY NOW



Jorvet Heavy Duty Nail Trimmer

Smaller and lighter version of JOR84h. Safety lock opening 5/16". Perfect for small and medium-sized breeds.

JOR84HR Trimmer, 6 1/2"L \$10.20/ea

JOR84HSR Trimmer, 5 1/2"L \$10.50/ea

BUY NOW



Jorvet Heavy Duty Nail Scissors

A must for trimming nails of bigger breeds. Nylon handle. Blade opening 7/16" with safety lock.

JOR84H Stainless Steel Blades, 6 1/2"L \$10.20/ea

JorVet



Terminator Nail Trimmer

This nail trimmer will cut through the heaviest of nails with ease, making the trimming of even the largest, toughest nails simple. About 1/3 larger than the JOR84h heavy duty nail trimmer.

JOR84HX \$13.50/ea **JorVet BUY NOW**



Heavy Duty Nail Trimmer

Smaller and lighter version of JOR84h. Safety lock opening 5/16". Perfect for small and medium-sized breeds.

JOR84HS Small, 5" \$9.90/ea **BUY NOW**



Lint Pick Up Device

Use this handy item to remove lint from fabric clothing and other surfaces without messy adhesive residue. Double reversible tape, perforated every 4" for fast removal and zero waste.

LINT Roller complete \$2.99/ea

Lint Pick Up Device Refill

LINT-R Refill \$2.70/ea

Terry Towel

Thirsty terry hand towels and bath towels. Designed to fit every need and every budget.

TOWEL-B Terry Bath Towel, 1 Dozen \$27.99/ea

TOWEL-H Terry Hand 12" x 12 .75" LBS., 1 Dozen \$4.99/ea



Grooming - Tubs, Tables & Accessories

Walk-In Stainless Steel Tub

All parts are stainless steel. Great for all breeders. Fabricated with heavy 18 gauge 304 stainless steel. Swing-in swing-out 18 gauge stainless ramp. 16 gauge round tubing leg and frame assembly. Removable stainless entry allows complete view. Accommodates breeds up to 300 lbs. Available in 48" or 58" lengths. Plumbing on right or left side. Clean out hair trap. 4 back wall eye-hooks.

AQ48U 48" x 24" x 28"H \$3,109.06/ea



BUY NOW

Walk-In Stainless Steel Tub

All parts are stainless steel. Great for all breeds. Fabricated with heavy 18 gauge 304 stainless steel. Swing-in swing-out 18 gauge stainless ramp. 16 gauge round tubing leg and frame assembly. Removable stainless entry allows complete view. Accommodates breeds up to 300 lbs. Available in 48" or 58" lengths. Plumbing on right or left side. Clean out hair trap. 4 back wall eye-hooks.

AQ58K 58" x 24" x 28"H \$3,208.26/ea



BUY NOW

White's Toenail Scissors

JOR84 4" \$6.90/ea



BUY NOW

Groom-Aid Spray

Evesco Groom-Aid Spray 7.3 oz for veterinary use contains a lanolin derivative which adds a luster and sheen to your animal's coat. Groom-Aid helps keep the animal's coat tangle-free. This non-greasy formula absorbs quickly. When applied after bathing, Groom-Aid makes your animal's coat easy to comb, brush and groom. Groom-Aid contains isopropyl alcohol and mineral spirits.

RXGROOM-AID 7.3oz spray \$13.99/ea



BUY NOW

Grooming Sleeves

Our durable, nylon pack cloth Apron with Grooming Sleeves is available in three sizes and colors. The quick-close, quick release buckle and adjustable neck strap provide a neat, tailored fit for all. The large pocket is ideal for all pet-care and grooming needs. Our Grooming Sleeves offer added protection to skin and clothing from shampoos and dips.

SL-1B Blue, One Size Fits All \$10.13/ea
 SL-1G Green, One Size Fits All \$10.13/ea
 SL-1R Red, One Size Fits All \$10.13/ea



Grooming Table

Designed to last a lifetime, this stout grooming table features tubular legs with bright chrome plating. Tabletop is made of 3/4" solid plywood (not particle board) and finished with easy-to-clean no-skid vinyl. A piece of 1" extruded plastic molding makes for a reliable and attractive table.

490P 18" X 30" X 33"H \$109.65/ea
 500P 24" X 36" X 30.5"H \$115.80/ea
 500-48P 24" x 48" x 30.5"H \$129.75/ea



BUY NOW

Mobile Grooming Table

This mobile/collapsible grooming table comes with folding chrome, tubular legs equipped with large casters which allows the table to be used as a dolly. Tabletop is plywood with no-skid vinyl. 150lbs test weight.

505PW 24" x 36" x 30.5"H \$153.00/ea



BUY NOW

Grooming Table Arm

These grooming posts come in two lengths and are available with or without clamps. Type without clamp is for use with tables that have the post going through.

500-36 36" Through Table Arm \$25.00/ea
 500-48 48" Through Table Arm w/Clamp \$31.65/ea
 501GA-36 36" Arm and Clamp \$30.45/ea
 501GA-48 48" Arm and Clamp \$32.40/ea



BUY NOW

Grooming Noose

These nylon grooming nooses are used for controlling an animal while it is being groomed. Simply place the noose on the animal and attach the noose to a grooming post.

CP82114 Blue \$1.50/ea
 CP82115 Red \$1.50/ea



NEW

Pet Bath Hose

Lightweight durable 5 ft stainless steel hose and spray head. Light enough to be used all day. Spray force and pattern can be altered to work more efficiently.

PL972 Spray w/hose \$99.00/ea



BUY NOW

Hair Strainer

Catches fine dog and cat hairs and keeps them out of the drain pipes. Efficient nonclog design. Use on any 3 1/2" strainer.

PL500 3 1/2" Plastic \$14.56/ea



BUY NOW

Pet, Grooming & Restraints

Grooming - Shampoo, Conditioner & Cologne

Magic Coat PLUS Flea and Tick Shampoo

This extra strength formula was made specifically for dogs with a heavy infestation of fleas, ticks or lice. This shampoo not only kills all those little pests, it also leaves your dogs coat looking shiny and smelling great.

AP-F10610 16oz \$5.50/ea **BUY NOW**



Magic Coat Flea and Tick Shampoo

This shampoo has been formulated to kill fleas, ticks, and lice on dogs, cats, puppies and kittens without harming their coat or skin. It is a rich, highly concentrated shampoo that will give your pet a lustrous, fresh smelling coat.

AP-F10620 16oz \$5.40/ea **BUY NOW**



Magic Coat Puppy Tearless Shampoo with Aloe Vera, Protein and Lanolin

This shampoo will not irritate your puppy's eyes but it will leave the coat shiny, fresh and easy to manage. It cleans gently and thoroughly while eliminating puppy odors.

AP-F10650 16oz \$3.98/ea **BUY NOW**



Magic Coat Protein Tearless Shampoo

Give your dog's coat an amazing shine with this conditioning shampoo made for dogs and puppies. It will bring out your dog's natural lustre without irritating his skin or eyes.

AP-F10640 12oz \$3.75/ea **BUY NOW**



Crystal Eye

Crystal Eye Tear Stain remover is safe for dogs and cats. Quickly and easily removes the brown staining around the eyes and in skin folds.

AP-F01738 4oz \$4.14/btl **BUY NOW**



Four Paws Fresh Essence Cologne

Completely deodorize your pet's coat with this long-lasting, refreshing fragrance.

AP-F10540 6oz \$5.58/ea **BUY NOW**



Four Paws Cologne

For the pet that has everything. An exciting spray-on fragrance that lasts up to 24 hours.

AP-F10500 3oz \$5.94/ea **BUY NOW**



Four Paws Instant Dry Shampoo & Deodorant

BUY NOW

Now you can shampoo your pet anytime, anywhere, faster and easier than ever before. Used as a whitener-cleaner by professionals, this product removes greasy and grimy substances from fur. No water is required. It will leave your pets coat lustrous, pleasantly-scented and easy to manage.

AP-F10520 7oz \$4.60/ea

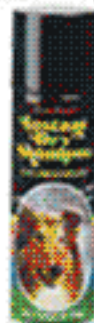

Chloraderm Shampoo

BUY NOW

This shampoo is a gentle antimicrobial shampoo safe for most animals. It has chlorhexidine gluconate for antimicrobial activity. It also has moisturizers and a fresh scent to leave the coat looking, smelling and feeling its best.

RXCHLORADERM 1%, 8oz \$2.99/btl



Malacetic Shampoo

BUY NOW

This patented, pleasant smelling, acetic acid/boric acid shampoo is a revolutionary breakthrough in topical dermatology therapy. It is all natural and contains no soaps, dyes or animal protein. Acetic and Boric Acids have been used since medieval times for various maladies. Acetic acid is a known conditioner for hair leaving it clean, soft and lustrous while removing soap, scales, dandruff and other residue.

RXMAL-SHM16 16oz \$12.16/btl
RXMAL-SHAMG Gallon \$72.99/gal



Malacetic Shampoo

BUY NOW

RXMAL-SHM8 8oz \$17.90/btl

Malacetic Otic

BUY NOW

RXMALOTIC-4 4oz \$7.55/btl
RXMALOTIC-16 16oz \$17.99/btl



Malacetic Wet Wipes

RXMAL-WIPE 5" x 9" Wipes, 25/pack \$10.45/pk

Malacetic Conditioner

MalAcetic is now available in an easy to use leave-on, dry-on, ALCOHOL and PEG FREE Conditioner. Convenient to use after using ANY shampoo or by itself for the busy pet owner. This patented, pleasant smelling, acetic acid/boric acid Conditioner is a revolutionary breakthrough in topical dermatology therapy. DermaPet Hypo-Allergenic Conditioner. It is all natural and contains no alcohol or polyethylene glycol which are both found in competitive products containing miconazole.

RXMAL-CON8 8oz \$7.69/btl **BUY NOW**



Pet, Grooming & Restraints

Pets - OTC Medications & Dental Products

biotene
veterinarian

BUY NOW



Biotene Antiseptic Oral Gel

RXBIOGEL-6 1oz tube, 6 tubes/pk

\$51⁸⁶/pk

Biotene Maintenance Kit

RXBIOKIT-6 6 kits/pk

\$26⁹⁹/pk

Yuk-2e Anti-Lick Gel

RXYUK-0.5 0.5oz

BUY NOW

\$4⁹⁹/btl



Bitter Rid Spray

BUY NOW

Bitter Rid Spray discourages animals from licking, biting and chewing. It tastes so bad they don't want to do it. It is non-flammable, non-poisonous, non-staining and pleasant smelling. You can apply it to bandages, casts, hair or household furniture.

RXBIT-4 4 oz bottle \$2.71/btl



Forbid

BUY NOW

FOR-BID stops coprophagy (pets eating stool). Vegetable protein and sodium glutamate work in the digestive system to give stools a bad taste.

RXFORBID-12 12/pack \$21.25/pk



Omega 3 Gel Caps

BUY NOW

Omega 3 fatty acids help support healthy skin, coat, joints and heart!

RXOMESD-60 Small Dog, 60 gelcaps \$4.99/btl

RXOMELD-60 Large Dog, 60 gelcaps \$5.99/btl



Eicosaderm

BUY NOW

RXEICO-8 EPA 360mg/DHA 240mg, 8oz

\$12²⁵/btl

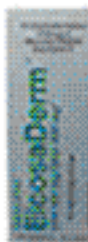

Cat Lax

BUY NOW

A palatable formula for the prevention and elimination of hairballs in cats.

RXCAT-LAX 2oz \$3.10/ea



CET Fingerbrush with Paste

RXCET-12 1 brush, 12gm paste

BUY NOW

\$4⁴⁰/ea

Chlorhexidine and Zinc Oral Spray

RXCHZN-8 8oz bottle

BUY NOW

\$4⁵⁰/btl

Clean and Fresh Oral Spray

RXCLEAN-8 0.1%, 8oz

BUY NOW

\$4⁵⁰/btl

PetDental Care Kit

BUY NOW

The PetDental Care Kit comes with a 2.5oz tube of toothpaste, a finger brush to massage the gums, and a long handle, two sided toothbrush. The toothbrush is specially angled to make brushing your pets teeth easier. Keep your pets healthy and smelling great!

AP-F41020 dogs \$6.22/ea

AP-F41022 cats \$5.05/ea



PetDental Toothpaste

BUY NOW

PetDental Toothpaste with fluoride is recommended by veterinarians to help fight plaque and tartar build-up, combat gum disease, and control unpleasant breath.

AP-F41015 cats, 2.5oz \$3.42/ea



Tapeworm (Praziquantal) Tablets

Dogs and cats can be infested with two types of tapeworms. Fleas carry the most common type, and rodents carry the less common type. Until recently, the only effective control has required a prescription. However, this drug (Praziquantal) is now available without a prescription, and is 100% effective in ridding your pet of both types of tapeworms.

RXOTC8783 Feline, 3 tablets/bottle \$10.50/btl

RXOTC8785 Canine, 5 tablets/bottle \$16.99/btl

BUY NOW



Pet Pill Crusher



BUY NOW

Many times a tablet or pill is too large for a pet to swallow. In addition, a pill can be crushed to hide in the animal's food or in a treat. This pill crusher works by dropping the pill into the clear chamber and screwing the top portion directly into it. It also has a handy storage area in the lid to keep extra tablets close by. Top and bottom have raised knurled ridges for easy tightening. Made of high impact plastic.

JOR613 Packaged in blister pack display. \$2.55/ea

JorVet

No returns on pharmaceuticals • Prices subject to change without notice. Shipping charges for refrigerated items are a flat charge based on your shipping zone. Customer accepts full responsibility for condition of products upon receipt.

13822 WEST BOULTON BLVD. METTAWA, IL 60045

WWW.SHOPMEDVET.COM

Phone 800-544-7521

159

Fax 800-204-2177

Pet, Grooming & Restraints

Pets - Medical Products

Dentacetic Dentees Chews

Abrasive action and patented ingredients, HMP and acetic acid, help decrease buildup of dental plaque and block formation of tartar. The chewing physically removes both! Also brightens teeth. All in one delicious chew!

RXDEN-CHEW 10oz pack \$10.99/pk

Dentacetic Dentees Stars

RXDEN-STARS 4oz pack \$7.00/pk

Dentacetic Gel

An acetic acid tooth and gum gel with sodium hexametaphosphate. The former creates a multifunctional dental product which degrades better, brightens teeth and has excellent antimicrobial effects with fewer side effects (it does not stain). The sodium hexametaphosphate is to prevent tartar and calculi formation.

RXDEN-GEL 2oz \$4.79/btl

Dentacetic Wipes

RXDEN-WIPES 25 wipes/pack \$7.29/pk

Thermo Pet Mat

A less expensive warming unit, consisting of a blue flexible 6-watt warming pad placed inside a washable faux lambskin cover. The convenient 14" x 28" size fits all standard cages. The pad is preset to be thermostatically controlled to 102°. U.L. approved. Limited one-year warranty.

JOR917 14" x 28" \$45.90/ea

Jorvet Deluxe Lectro-Kennel

The new Lectro-Kennel has a digital temperature control built right into the pad.

- Adjustable from 80° to 100°F
- Can be read in either Celsius or Fahrenheit
- Includes sheepskin cover

Constructed of rugged, brown ABS plastic, the pad is completely water tight, easily cleaned, suitable for all makes of cages as well as kennel runs. Lectro-Kennel is equipped with a steel wrapped abrasion resistant electrical cord. One-year warranty.

JOR916B Large, 22 1/2" x 28 1/2", 80 watt \$176.00/ea

Jorvet Lectro Cover

This optional faux lambskin cover is soft, comfortable and machine washable. The cover slips over the Lectro-Kennel.

JOR916X Small \$15.60/ea

JOR916Y Medium \$19.50/ea

JOR916Z Large \$22.50/ea

Jorvet Walka Boot

Protective water resistant boot made with a durable neoprene shell. The boot has a moisture absorbing liner that keeps pets feet drier. Rubber sole provides support and insulation. Machine washable, line dry. ** Due to the risk of infection, Jorvet regrets that it cannot accept a return of this product once the product has been placed on an animal.

JOR456W Small \$15.00/ea
 JOR456X Medium \$16.50/ea
 JOR456Y Medium Large \$19.50/ea
 JOR456Z Large \$21.00/ea

Web Master Harness

The safe use of hydrotherapy should include either a float coat or, for advanced swimmers, a safety harness. No patient should be swimming with just a single collar. The Web master Harness has a three point system with a "D" ring. The lifting handle is low profile with a quick release snap. The harness is made of heavy-duty nylon material for durability. A secure but comfortable harness designed especially for hydrotherapy. Color is red and black.

JOR979A XX Small, Primary Measurement 12" - 19", Dog Length 10" \$67.00/ea
 JOR979B XSmall, Primary Measurement 17" - 24", Dog Length 12 3/4" \$67.00/ea
 JOR979C Small, Primary Measurement 18" - 30", Dog Length 15 1/2" \$67.00/ea
 JOR979D Medium, Primary Measurement 23" - 36", Dog Length 19" \$67.00/ea
 JOR979S Set of 5 \$240.00/set

Jorvet Evan's Mobility Cart

Veterinarians frequently encounter patients that are non-ambulatory, either temporarily or even permanently. Providing these patients with the proper support is a difficult challenge, yet necessary to get the patient up and moving to achieve maximum rehabilitation. The Evan's mobility cart was designed by a veterinarian to help any animal that is "down" on hind or front limbs due to post surgery or trauma, paralysis, hip dysplasia or other arthritic conditions. **The cart features:**

- Tough, durable framework constructed of powder coated lightweight tubular steel
- Four legs with casters with bearings, allowing 360° range of motion
- Reduced risk of cart turnover
- Washable and adjustable nylon mesh saddle support

JOR865A Medium \$325.00/ea
 JOR865B Large \$362.00/ea
 JOR865C X-Large \$400.00/ea
 JOR865 Small \$304.00/ea

Web Sling Only for Cart

JOR865AW Medium \$43.50/ea
 JOR865BW Large \$58.50/ea
 JOR865CW X Large \$63.00/ea
 JOR865W Small \$39.00/ea

Pet, Grooming & Restraints

Pets - Medical Products

Jorvet Pet Nursing Kit

This baby bottle is ideal for supplementing milk to newborn small pets. The clear silicone nipple is very long-lasting. The bottle has clearly marked measurements on its side. Also includes bottle cleaning brush and extra silicon nipple

JOR787	50ml	\$3.00/ea
JOR787L	150ml	\$2.70/ea

BUY NOW



Jorvet Mothering Kit

JorVet

This unique kit features a tiny syringe gun with three interchangeable tiny clear silicone nipples. The concept is to draw milk up into the tiny syringe then attach a nipple. The milk is slowly administered as the newborn starts to suckle. Allows the feeding of the smallest of animals.

JOR788	Kit includes clear silicone nipples and syringe.	\$1.50/ea
--------	--	-----------



BUY NOW

Dog Pad Protector

BUY NOW

An All-Natural treatment for wound care. Creates a protective barrier, cleans the wound, and aids rapid healing.

RXCUT-PAD	4oz	\$8.65/btl
-----------	-----	------------

Cut-Heal Wound Spray

RXCUT-SPRAY	4oz	\$7.21/btl
-------------	-----	------------



BUY NOW

Mesh Bath Sack

BUY NOW

Great for home care, the Bath Sack™ features a heavy-duty, polyester mesh fabric that allows for easier use, while helping to protect yourself from unruly cats. Ideal for bathing, rinsing and dipping cats and other small animals at home, clinic or kennel.

BS-1	Small, for Cats Up to 8 lbs.	\$15.75/ea
BS-2	Large, for Cats 8-20 lbs.	\$18.56/ea
BS-SET	Set, for Cats Small & Large	\$32.63/set



Jorvet Canine Sidebars

JorVet

BUY NOW

A new restraint bar designed to prevent the patient from turning and chewing or licking any wound located anywhere on the body behind the shoulders. The animal's head is free to move about to eat and drink. The lightweight aluminum bar is configured to go over the top of both shoulders and then directed backward past the rib cage. It is held in place with adjustable Velcro straps along the belly and over the front of the chest. Developed in conjunction with the Colorado State University School of Veterinary Medicine. (NOTE: Not suitable for front leg wounds.)

JOR1078A	Jack Russell - rod = 0.65cm dia - xls chart; A = 7" B = 4" C = 7"	\$23.25/ea
----------	---	------------



All Purpose Apron

BUY NOW

This royal blue nylon cloth apron has an adjustable neck strap and a quick release buckle. Comfortable fit. Front dual pockets.

JOR171	Small	\$12.00/ea
JOR171A	Large	\$15.00/ea



**SEE OUR
SCRUBS AND APPAREL
SECTION FOR A FULL
ASSORTMENT OF APRONS**

FREE



Your choice... With qualifying purchase
See inside cover for details, certain restrictions apply...

Pet, Grooming & Restraints

Pets - Ear Treatments & Paw Protectors

Oticare P Ear Powder

BUY NOW

Oticare P Ear Powder for dogs and cats helps keep the ears dry and reduces ear odor. It is also used to help remove hair from the ear canals of dogs.

RX0TIC66606 6 gram \$3.50/btl

Oticare A Ear Cleaner

BUY NOW

For routine cleaning and odor control of the ear canal.

RX0TIC66704 4oz \$4.50/btl

Otisothe II Ear Cleaner

BUY NOW

For routine cleaning and odor control of the ear canal.

RX0TIC66716 16oz \$10.25/btl

Ear Cleaner with Aloe

BUY NOW

RX0TIC-JC 4oz bottle

\$2.45/btl
Not Pictured

Ear Mite Killer

BUY NOW

Ear mite killer with aloe for use in cats, dogs and horses. Kills on contact.

RXEARMITE-6 6oz \$5.99/btl



Feliway

BUY NOW

Feliway® is a synthetic copy of the feline facial pheromone, used by cats to mark their territory as safe and secure. By mimicking the cat's natural facial pheromones, Feliway® creates a state of familiarity and security in the cat's environment. As a result, Feliway® can be used to help comfort and reassure cats.

RXFELWAY-REF Refill, 48ml \$14.95/ea



Styptic Powder

BUY NOW

A safe, quick styptic powder aid with antiseptic to stop bleeding caused by clipping nails, dew claws, ear cropping, docking tails, trimming beaks and minor cuts.

CP4100 1/2 Oz Ea Vet Use \$2.75/ea

CP4101 1.25 Oz Ea Vet Use \$5.99/ea

CP4102 16 Oz Ea Vet Use \$11.50/ea



Kwik-Stop Styptic Powder

BUY NOW

Kwik-Stop forms an instant barrier to stop bleeding fast. Used as an aid to stop bleeding caused by clipping nails, docking tails and minor superficial cuts in dogs and cats.

RXXWK-STOP 0.5 oz (14g) \$6.98/ea

RXXWK-STOP1.5 1.5 oz (42g) \$12.36/ea



Jorvet TheraPaw Protector

BUY NOW

Padded and supportive boots for painful or injured paws provides superior protection against environmental hazards. Recommended uses include: paw and bandage protection after surgery; management of cuts, burns, torn tendons and ligaments; ideal for hydro-therapy and rehabilitation; excellent traction for unstable dogs. **Features include:**

- Ultra-cushioned interior padded base
- Rubberized, waterproof, tractioned sole
- Breathable Airprene sock/sleeve
- Double-closing Velcro lapels for additional security
- Seamless interior
- Quick drying and easy maintenance



JorVet

JOR864A	Small, Paw Length 2 1/2", Paw Width 2", Weight 15-35 lbs., Wrist/Ankle Circumference Up to 3 1/2", Wrist/Ankle Height 2 1/4"	\$21.00/ea
JOR864AB	Small-Medium, Paw Length 2 3/4", Paw Width 2 1/4", Weight 30-50 lbs., Wrist/Ankle Circumference Up to 4 1/2", Wrist/Ankle Height 2 3/4"	\$24.00/ea
JOR864ABB	Small-Medium #2, Paw Length 3 3/4", Paw Width 2 1/2", Weight 40-70 lbs., Wrist/Ankle Circumference Up to 4 1/2", Wrist/Ankle Height 3"	\$22.50/ea

JOR864B	Medium, Paw Length 3 1/2", Paw Width 2 3/4", Weight 60-90 lbs., Wrist/Ankle Circumference Up to 5", Wrist/Ankle Height 3"	\$22.50/ea
JOR864BC	Medium-Large, Paw Length 3 3/4", Paw Width 3", Weight 80-110 lbs., Wrist/Ankle Circumference Up to 5 1/2", Wrist/Ankle Height 3 3/4"	\$24.00/ea
JOR864C	Large, Paw Length 4 1/4", Paw Width 3 1/2", Weight 100-130 lbs., Wrist/Ankle Circumference Up to 6 1/2", Wrist/Ankle Height 4 1/4"	\$24.00/ea



VetMed Care Protective Bodysuit

This new line of protective body wear has been used extensively by veterinarians throughout Europe. A wide range of applications has evolved literally from head to tail on a whole host of different species. Traditional methods of wound protection such as "E" collars, and adhesive tapes have several known disadvantages. The VetMedCare protective body wear offers a great alternative to wound protection. Body suits are easy to handle and protect sensitive areas from dirt, scratching and licking. Thoughtful design provides front and back leg openings that have special flat and stretch seams which help avoid limb irritations or abrasions. The belly is fully smooth, as the seam is along the back. Anatomical differences require consideration of both male and female designs. **Material and Sizes:**

Female		
JOR1055A	X-Small, Neck 6-8", Chest 8"-10", Distance Between Front/Back legs 9.5"	\$24.00/ea
JOR1055B	Small, Neck 8-10", Chest 12"-16" Distance Between Front /Back Legs 15"	\$27.00/ea
JOR1055C	Medium, Neck 10-14", Chest 16-20", Distance Between Front/Back Legs 18"	\$27.00/ea
JOR1055D	Large, Neck 14-18", Chest 18"-24", Distance Between Front/Back Legs 19.75"	\$28.00/ea
JOR1055E	X-Large, Neck 18-22", Chest 24"-30", Distance Between Front/Back Legs 23.5"	\$36.00/ea
JOR1055F	XX-Large, Neck 22-24", Chest 26"-35", Distance Between Front/Back Legs 26.5"	\$33.60/ea
JOR1055G	Leg/Head Extremity, set of 4	\$36.00/ea
JOR1055S	All 6 sizes, both female and male bodysuits and all 4 sizes of leg/head extremities 18 pieces, Snap connectors.	\$225.00/ea

BUY NOW

JorVet

- Very Elastic, stretches in all directions for a comfortable fit
- Wash and wear material: easy to clean, just hang to dry
- Can be trimmed to custom size or shape and not fray or run
- Wide range of sizes (6) to fit all small animals
- Green/blue color is neutral surgery color

Some applications:

- Surgical sites
- Chest drains
- Aural hematomas
- PEG tubes
- Open wounds
- Additional protection over bandaged wounds
- Can actually hold telfa pads tightly in place through use of simple snaps
- Provides cosmetic benefits over unsightly wounds/injuries
- Clients love them and so do the patients!
- Leg and extremity protection:
- The special elastic tube-shaped material can cover leg or head wounds
- They attach to the body suit by light-weight simple snaps
- Head protection: trim in eyes and ears and/or trim to length desired

Cone shaped product is designed for rear leg

Male		
JOR1055AM	X-Small, Neck 6-8", Chest 8"-10", Distance Between Front/Back Legs 9.5"	\$23.00/ea
JOR1055BM	Small, Neck 8-10", Chest 12"-16" Distance Between Front /Back Legs 15"	\$23.00/ea
JOR1055CM	Medium, Neck 10-14", Chest 16-20", Distance Between Front/Back Legs 18"	\$28.50/ea
JOR1055DM	Large, Neck 14-18", Chest 18"-24", Distance Between Front/Back Legs 19.75"	\$33.00/ea
JOR1055EM	X-Large, Neck 18-22", Chest 24"-30", Distance Between Front/Back Legs 23.5"	\$36.00/ea
JOR1055FM	XX-Large, Neck 22-24", Chest 26"-35", Distance Between Front/Back Legs 26.5"	\$33.60/ea





The Walkabout™ Harness

JorVet

The options for a paralyzed dog or cat are limited. Their quality of life depends upon the owner's ability to deal effectively with their situation. Euthanasia often is chosen. Today's pet owner wants other choices, and the Walkabout™ provides the alternative. The design and construction of the Walkabout™ harness provides the balance and support necessary for your pet to lead a happier, healthier and cleaner life. Use of the Walkabout also can help minimize the owner's back strain that can result from lifting and carrying the pet. Used by over 20 veterinary teaching institutions like the Animal Medical Center in New York, and the Research Center for Paralysis at Purdue University.

- **Front Harness:** A smooth, semicircular neckline allows your pet to breathe comfortably, while simultaneously supporting his/her front end.
- **Combination Harness:** Double harnessing may provide the safest and most comfortable means to transport your pet. Measurements are necessary for both front and back. Special Order.
- **Amputee Harness:** A custom design provides a harness for pets who have lost a limb. Special Order. Rear Harness.

JOR456A	X-Small, A 9" - 15", B 3" - 6"	\$40.00/ea
JOR456B	Small, A 10" - 16", B 3" - 8"	\$42.00/ea
JOR456C	Medium, A 15" - 12", B 6" - 12"	\$53.00/ea
JOR456D	Medium-Large, A 20" - 29", B 11" - 15"	\$65.00/ea
JOR456E	Large, A 24" - 31", B 14" - 17"	\$78.00/ea
JOR456F	X-Large, A 31" - 35", B 16" - 19"	\$87.00/ea
JOR456S	Set of 6	\$295.00/set



Deluxe Double Door Crate

BUY NOW

The K-9 Keeper Deluxe Dog Crate comes fully assembled. It is completely collapsible for easy carrying and storage. There are two full doors, one on the front and one on the side, for added convenience. The ABS plastic tray on the bottom removes easily for effortless cleaning.

AP-F57419	19" x 12" x 15"	\$47.99/ea
AP-F57424	24.25 x 17 x 20.25"	\$59.99/ea
AP-F57430	30" x 21" x 24" with divider panel	\$68.99/ea
AP-F57436	36" x 23" x 26"	\$82.99/ea
AP-F57442	42" x 28" x 31"	\$102.99/ea
AP-F57448	48" x 30" x 33" with divider panel	\$125.00/ea

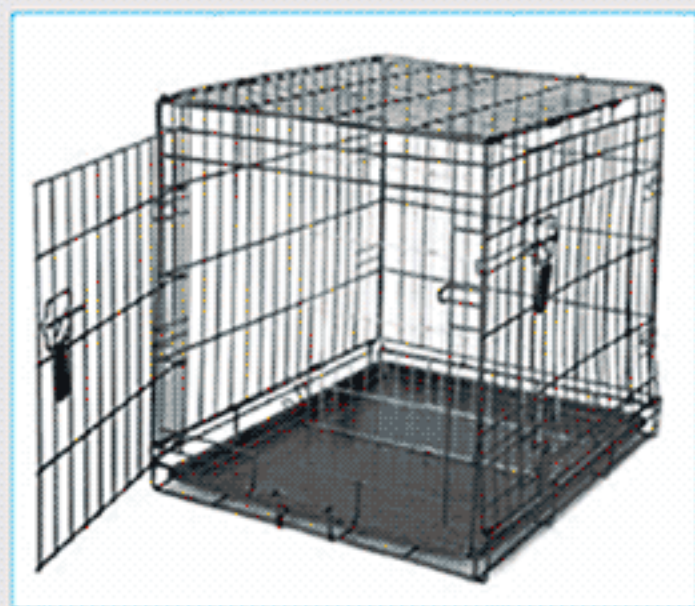

ID-Band



BUY NOW

Ideal for short or long term positive identification of animals, easy to apply. Each carton includes a permanent marking pen. Can also use ball point pen or pencil. Pressure sensitive adhesive tabs ensure band will remain on patient until removed. Three sizes, solid or mixed colors are available.

EJIDY20	Yellow, 20" x 1", 500/cs	\$44.35/cs
EJDKT333	White, 1 Marker, 250" Tape Roll	\$24.60/cs
EJDM30	Mixed Colors, 30" x 1", 100/cs	\$24.01/cs
EJDB30	Blue, 30"x1", 100/cs	\$24.01/cs
EJIDW10	White, 10" x 1", 500/cs	\$39.55/cs
EJDR20	Red, 20" x 1", 500/cs	\$44.35/cs
EJIDG10	Green, 10" x 1", 500/cs	\$39.55/cs
EJIDG30	Green, 30" x 1", 100/cs	\$23.37/cs
EJIDW20	White, 20" x 1", 500/cs	\$44.35/cs
EJDB10	Blue, 10"x1", 500/cs	\$40.66/cs
EJIDW30	White, 30" x 1", 100/bx	\$23.37/cs
EJIDY30	Yellow, 30" x 1", 100/cs	\$23.37/cs
EJID030	Orange, 30" x 1", 100/cs	\$23.37/cs
EJDB20	Blue, 20"x1", 500/cs	\$45.60/cs
EJIDG20	Green, 20" x 1", 500/cs	\$45.60/cs
EJID020	Orange, 20" x 1", 500/cs	\$44.35/cs
EJDR10	Red, 10" x 1", 500/cs	\$40.66/cs
EJIDY10	Yellow, 10" x 1", 500/cs	\$39.55/cs
EJID010	Orange, 10" x 1", 500/cs	\$40.66/cs
EJDR30	Red, 30" x 1", 100/cs	\$24.01/cs

ID Bands Mixed Colors

Manufactured with strong and tough spun bonded olefin. They are very soft and comfortable. Colored bands with white on the reverse. Bands fit most animals. For larger animals two bands may be attached. 500 per box.

EJDM-10	Mixed Colors, 10", 500/cs	\$41.79/bx
EJDM-20	Mixed Colors, 20", 500/cs	\$46.19/bx

ID Band Roll

EJKT-333	Continuous Roll, 333", white (Requires EJDT250 Sure Hold Tape)	\$24.60/ea
EJDT250	Sure Hold Tape, 250" Length Tape Only	\$6.81/cs



BUY NOW

Ejay Haylo

BUY NOW

Ejay Haylo the next generation of effective humane protection for post operative patients that require the area behind patients neck to be protected from patients muzzle.



EJHAY625	9" Width, 10"-21.50" Neck Circumference	\$5.86/ea
EJHAY007	2 of each size, except HAY105	\$60.45/ea
EJHAY312	5.50" Width, 8"-15" Neck Circumference	\$3.48/ea
EJHAY105	3" Width, 5"-12", Neck Circumference	\$3.11/ea
EJHAY210	4" Width, 7"-13.50" Neck Circumference	\$3.30/ea
EJHAY415	7" Width, 9"-17" Neck Circumference	\$4.58/ea
EJHAY520	8" Width, 9"-19.50" Neck Circumference	\$4.85/ea
EJHAY730	12" Width, 14"-28.50" Neck Circumference	\$6.60/ea

Kong ZoomGroom

BUY NOW

Removes loose hair like a magnet, stimulates capillaries and natural oil production for healthy skin and coats.

EJZG2	Boysenberry, Soft, Flexible, Groom & Shampoo	\$6.16/ea
EJCZG	Cat, Soft, Flexible, Groom & Shampoo	\$4.85/ea
EJZG1	Raspberry, Soft, Flexible, Groom & Shampoo	\$5.97/ea
EJZG3	Lemon, Soft, Flexible, Groom & Shampoo	\$6.16/ea

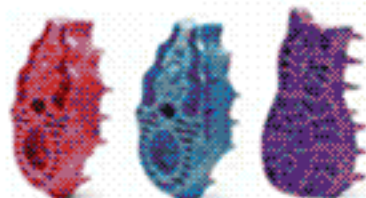

Kong Air Squeaker Donut

Durable, high-quality Air Squeaker Donut will not wear down a dog's teeth since they are made with a special nonabrasive felt, compared to the abrasive material on normal tennis balls.

- Perfect for games of fetch
- Squeaker to induce play
- Nonabrasive tennis material will not wear down your dog's teeth.

EJASD2	medium	\$4.35/ea
--------	--------	-----------



BUY NOW

Feral Cat Den

BUY NOW

The ACES den is designed to provide a frightened or fractious animal a quiet "hiding place". Secure the animal inside by closing the porthole door then remove the den (and animal) from the cage for cleaning, treatment, or transport. Completely eliminates risk of handler injury while providing a stress-free environment for the animal. Dens are 15" x 11" x 10". Fit in any cage larger than 24" X 24".

ACE-M-FDGC	15" x 11" x 10"	\$133.50/ea
------------	-----------------	-------------



Pets - Pet Care

Fleece Pads

BUY NOW

Cotton-duck lined Fleece Pads provides kennel, car and home pet comfort. Our Fleece Pads are constructed of soft polyester fleece and a heavy 10 oz. cotton canvas backing for durability. One size only.

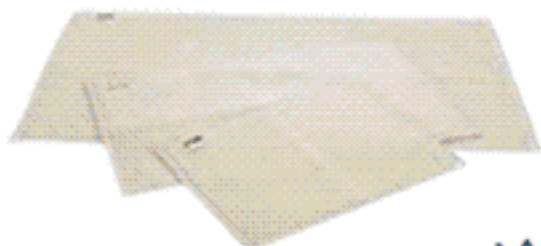

FP-1	12" x 16"	\$4.50/ea
FP-2	16" x 24"	\$9.84/ea
FP-3	20" x 36"	\$14.91/ea
FP-4	30" x 60"	\$25.88/ea



Magnetic Pet Pad

BUY NOW

Pets enjoy the feeling of warmth that emanates from the energy of the magnets. The convoluted foam used is also great as an orthopedic pad for older pets and those with hip problems.

P1616	16" X 16", 25 magnets	\$22.99/ea
P2432	24" X 32", 42 magnets	\$32.50/ea



BUSTER Dog Socks

JorVet

The sock is used as a cover for paw-bandages. It is made of rib-knitted cotton with a hard-wearing and waterproof sole so the bandage can "breathe." The sock is pulled tight upwards and fastened with 2 pieces of plain adhesive tape. Available in three sizes

JOR113B	Medium	\$12.00/ea
JOR113C	Large	\$12.00/ea
JOR113A	Small	\$12.00/ea



BUY NOW

Country Dreams Bed

The combination of an attractive finished wood frame, a reversible fleece/denim bed cover and an elevated bed frame makes this pet bed a welcome addition to your home. These beds are designed with pet and owner in mind. Pets love the comfortable bed because it is soft and cozy. The elevated bed provides comfort and support while sleeping on the soft fleece cushion. Pet owners love the neutral wood finish as it fits with almost any home décor, the detachable cushion is easy to remove for washing and the bed sets up in a few quick and easy steps. This is a welcome addition to any home and certain to make a pet happy for many years to come.



BUY NOW

CP42115	Small, 21" x 15"	\$39.99/ea
CP428220	Medium, 28" x 22"	\$59.99/ea
CP43925	Large, 39" x 25"	\$72.99/ea



Fleece Bed

BUY NOW

This Bed is the perfect solution for bedtime bliss. The padded fleece fabric provides a soft and cuddly slumber mat while the raised edge gives pillow-like support. Made with a durable, 100% polyester fleece shell.

- Quilted style construction keeps padding in place
- Foldable for easy storage & transport
- Machine washable
- Six convenient sizes
- Fits comfortably in most cages

CP13121	31 x 21"	\$22.00/ea
CP11814	18 x 14"	\$8.33/ea
CP12520	25 x 20"	\$15.33/ea
CP13725	37 x 25"	\$28.75/ea
CP14532	45 x 32"	\$43.17/ea
CP15133	51 x 33"	\$50.17/ea



Jorvet Canine Icer

BUY NOW

The use of cold or ice packs over recent surgical sites, or also for chronic joint pain is well accepted modality. Getting a consistent and even application on a canine patient is the challenge. Canine Icers™ are made of strong and insulating neoprene with soft interior pockets of lycra. Quick release straps allow for maximum adjustability.

JOR342A	Sifle-Small	\$65.00/ea
JOR342B	Sifle-Medium	\$65.00/ea
JOR342C	Sifle-X Large	\$65.00/ea
JOR342D	Sifle-Large	\$65.00/ea



Pets - Pet Care



Jorvet Disposable Food Tray Bowls

Disposable Food Tray Bowls are coated paper, which limits cost to just pennies each. They nest together and require little storage space. 1000/case



BUY NOW

JOR974A	5" X 4" X 1 1/2"	8 oz Capacity	\$44.50/cs
JOR974C	10" X 7" X 2 1/2"	5lb. Capacity	\$111.00/cs
JOR974B	6" X 5" X 1 3/4"	2 lb. Capacity	\$58.00/cs



Disposable Water and Food Bowls

constructed of a special high-density recyclable foam that is sturdy and completely waterproof. Perfect for either holding liquids or solid food. Hard to tip over.

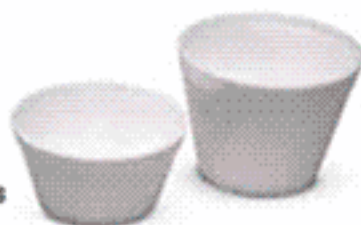

JOR975A	8oz. Capacity, 1000/case	\$94.00/cs
JOR975B	16oz. Capacity, 1000/case	\$105.00/cs

BUY NOW



Jorvet K-9 Float Coat



There is increasing popularity of water treadmills or just the use of swimming as an integral part of canine rehabilitation. A necessary safety precaution should be the use of a quality life preserver. Most of the standard retail preservers just cannot do the job like the Float Coat. The Float Coat has a durable nylon shell with an ergonomic fit. The coat is highly buoyant with a low profile assistance handle. This handle can lift the patient safely from the water. Canine patients will enjoy a safe aquatic adventure free from a scary struggle with K-9 Float Coat quick release buckles. Color: Yellow and Black

- Girth: measurement around the widest part of the rib cage Length: suggested minimum dog length from the back of the neck to the base of the tail.

JOR978C	Size Small, Dog Girth 23" - 30", Dog Length 16"	\$58.00/ea
---------	---	------------



BUY NOW

Stainless Steel Embossed Treat Canister

The perfect place to store treats for your pampered pets. These stylish stainless steel canisters are embossed with paw prints and have a bone shaped handle on the lid. Keeps treats fresh and looks good to you and your pet. With four sizes to choose from, you are sure to find one to fit your needs.

BUY NOW



CPWTC-3	Medium, 4 3/4" diameter x 5 1/4" high	\$8.68/ea
CPWTC-4	Large, 5 1/2" diameter x 5 3/4" high	\$9.99/ea
CPWTC-1	Mini, 4 1/4" diameter x 4 1/2" high	\$5.75/ea
CPWTC-2	Small, 4 1/2" diameter x 4 3/4" high	\$6.68/ea

**Shop 24 hours a day 7 days a week
From the comfort of your own home
WWW.SHOPMEDVET.COM**

Wee-Wee Pads

BUY NOW

Housetbreaking the easy way. The super absorbent Wee-Wee Pad will attract puppies when nature calls. The plastic lining prevents damage to floors and carpets. These disposable pads come in many sizes and quantities.

AP-F01612	For Little Dogs, 16.5" x 23.5", 12 pack	\$5.86/pk
AP-F01628	For Little Dogs, 16.5" x 23.5", 28 pack	\$11.70/pk
AP-F16000	23" x 24", 7 pack	\$3.52/pk
AP-F01614	22" x 23", 14 pack	\$6.22/pk
AP-F01630	22" x 23", 30 pack	\$12.34/pk
AP-F01635	22" x 23", 50 pack	\$19.80/pk
AP-F01640	22" x 23", 100 count bulk pack	\$33.84/pk
AP-F01648	X-large pads, 28" x 35.5", 21 pack	\$19.44/pk
AP-F01646	X-large pads, 28" x 35.5", 6 pack	\$5.50/pk
AP-F01647	X-large pads, 28" x 35.5", 14 pack	\$13.32/pk



Pet, Grooming & Restraints

Pets - Urns & Memorials

"Urnee" Cremation Urn **JorVet** **BUY NOW**

Many cremation urns presently used are very expensive human urns or inappropriate items such as coffee tins. The "Urnee" will satisfy the aesthetic requirements but at a cost low enough for routine use in returning crematory ashes.

- Attractive shape and color decorated with a raised relief rose centered on top
- Insert area for a memorable photo with snap-in cover
- Virtually unbreakable. Made from a heavy injection molded resin
- Inexpensive-costs about 1/4 of other urns
- Complete with a poly bag and tie for secure containment

JOR310SQ	Black, Animals <15 lbs.	\$8.70ea/ea
JOR310SQT	Tan, Animals <15 lbs.	\$9.00/ea
JOR310LO	Black, Large, 15-100 lbs.	\$11.85/ea
JOR310LOT	Tan, Large, 15-100 lbs.	\$12.15/ea



Jor310LO-SQ Series

Antique Bronze Heart Urn **BUY NOW**

JOR319G	2.9" x 2.7", 5 cu. in.	\$39.00/ea
---------	------------------------	------------

Calico Heart Urn

JOR319H	2.9" x 2.7", 5 cu. in.	\$39.00/ea
---------	------------------------	------------

Natural patina heart Urns

JOR319K	2.9" x 2.7", 5 cu. in.	\$33.00/ea
---------	------------------------	------------



Pet Burial Boxes **JorVet**

This is the professional and respectful way to return deceased pets to their owners. No more need to use old drug boxes. It is suggested to use a JOR108 cadaver bag, then place the animal in the burial box. Available in 3 sizes.

JOR308A	Small, 12-pack	\$75.00/dz
JOR308B	Medium, 10-pack	\$85.50/pk
JOR308C	Large, 5-pack	\$69.00/pk
JOR308	Intro pack (3 Small, 2 Medium, 1 Large)	\$65.50/pk

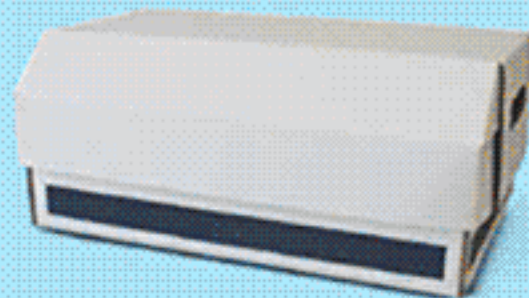

Pet Keepsake Memorials **BUY NOW**

Cherish the memories of your pet long after they've gone with this thoughtfully designed and crafted memorial. It is available in a number of sizes in honey maple or mahogany finish. You can choose a folding design or rotating pedestal. Each keepsake memorial folding design holds two of your cherished photos and has a secure compartment perfect for favorite toys, collars, or ashes. The rotating pedestal design holds four photos and has a secure compartment.

CP99668	medium folding in honey maple, 6x8"	\$23.50/ea
CP99669	large rotating in honey maple, 6x9"	\$30.99/ea
CP99768	medium folding in mahogany, 6x8"	\$23.50/ea
CP99769	large rotating in mahogany, 6x9"	\$30.99/ea



Pet, Grooming & Restraints



Pets - Urns

Terry Bear Urns **JorVet**

BUY NOW

Introducing an expanded range of designer style pet urns to offer veterinarian clients a wider range of choices for cremation urns. All urns have a threaded screw on lid for security.

Classic Bronze

JOR316A	Classic Bronze Urn, 5.7" x 3.9", 40 sq. in. capacity, Pet Weight up to 35 lbs., Small	\$39.00/ea
JOR316B	Classic Bronze Urn, 7.0" x 5.0", 85 sq. in. capacity, Pet Weight 35-65 lbs., Medium	\$55.00/ea
JOR316C	Classic Bronze Urn, 7.8" x 5.7", 125 sq. in. capacity, 55-100 lbs., Large	\$70.00/ea

Classic Pewter

JOR316D	Classic Pewter Urn, 5.7" x 3.9", 40 sq. in., up to 35 lbs., Small	\$39.00/ea
JOR316E	Classic Pewter Urn, 7.0" x 5.0", 85 sq. in., 35-65 lbs., Medium	\$55.00/ea
JOR316F	Classic Pewter Urn, 7.8" x 5.7", 125sq. in. 55-100 lbs., Large	\$70.00/ea



Dove Inlays

JOR316G	Going Home Urn-Contains Dove Inlays, 5.7" x 3.9", 40 sq. in., up to 35 lbs., Small	\$39.00/ea
JOR316H	Going Home Urn-Contains Dove Inlays, 7.0" x 5.0", 85 sq. in., 35-65 lbs., Medium	\$56.00/ea
JOR316J	Going Home Urn-Contains Dove Inlays, 7.8" x 5.7", 125 sq. in., 55-100 lbs., Large	\$68.00/ea

Silver Engraved

JOR316K	Silver Engraved Urn, 6.1" x 3.9", 25 sq. in., up to 15 lbs., X Small	\$38.00/ea
JOR316L	Silver Engraved Urn, 6.5" x 4.7", 40 sq. in., 10 to 35 lbs., Small	\$44.00/ea
JOR316M	Silver Engraved Urn, 7.5" x 5.6", 70 sq. in., 30-60 lbs., Medium	\$56.00/ea



Avalon Evening Blue

JOR316N	Avalon Evening Blue Urn, 5.8" x 4.3", 55 sq. in., up to 35lbs., Small	\$51.00/ea
JOR316P	Avalon Evening Blue Urn 7.4" x 5.2", 90sq. in., 35-65 lbs., Medium	\$66.00/ea
JOR316Q	Avalon Evening Blue Urn, 8.4" x 5.8", 130 sq. in., 55-100 lbs. Large	\$85.00/ea

Avalon Mahogany

JOR316R	Avalon Mahogany Urn, 8.4" x 5.8", 130 sq. in., 55-100 lbs. Large	\$51.00/ea
JOR316S	Avalon Mahogany Urn, 7.4" x 5.2", 90 sq. in., 35-65 lbs., Medium	\$66.00/ea
JOR316T	Avalon Mahogany Urn, 8.4" x 5.8", 130 sq. in., 55-100 lbs., Large	\$85.00/ea



Pewter/Brass Double Paw

JOR316OP	Pewter/Brass Double Paw Odyssey, 5.8" x 5.8" x 4.5", 70c.i.	\$52.00/ea
JOR316OPM	Pewter/Brass Double Paw Odyssey, 4.9" x 4.9" x 3.5", 40c.i.	\$40.00/ea
JOR316OPS	Pewter/Brass Double Paw Odyssey, 4.3" x 4.3" x 3.3" 25c.i.	\$34.00/ea

Slate/Pewter Single Paw

JOR316SPL	Slate/Pewter Single Paw Odyssey, 5.8" x 5.8" x 4.5", 70c.i.	\$52.00/ea
JOR316SPM	Slate/Pewter Single Paw Odyssey, 4.9" x 4.9" x 3.5", 40c.i.	\$40.00/ea
JOR316SPS	Slate/Pewter Single Paw Odyssey, 4.3" x 4.3" x 3.3", 25c.i.	\$34.00/ea

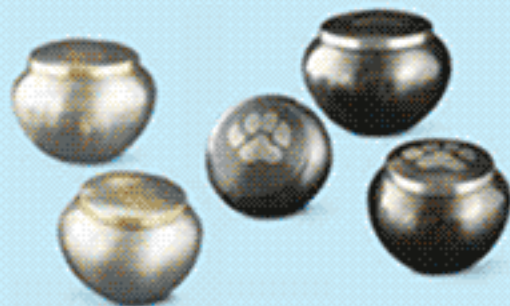

Crouching Cat

JOR317A	Crouching Cat Urn - Calico, 9.7" x 3.9", 35 sq. in., up to 30 lbs.	\$80.00/ea
JOR317B	Crouching Cat Urn - Patina, 9.2" x 4.6", 40 sq. in., up to 35 lbs.	\$80.00/ea

Sitting Cat

JOR317C	Sitting Cat Urn - Dark Bronze, 9.2" x 4.6", 40 sq. in., up to 35 lbs.	\$80.00/ea
JOR317D	Sitting Cat Urn - Calico, 9.7" x 3.9", 35 sq. in., up to 30 lbs.	\$80.00/ea

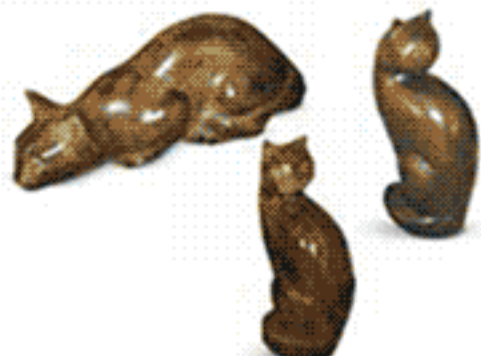



BUY NOW



Pewter/Slate Paw Urns **JorVet**

Introducing an expanded range of designer style pet urns to offer veterinarian clients a wider range of choices for cremation urns. All urns have a threaded screw on lid for security.

Pewter

JOR316DPH	Pewter/Brass Double Paw Heart Urn, 2.9" x 2.9" x 2.7", 5 cu.in.	\$39.00/ea
JOR316DPH	Pewter/Brass Double Paw Heart Urn, 2.9" x 2.9" x 2.7", 5 cu.in.	\$39.00/ea

Slate

JOR316SPH	Slate/Pewter Single Paw Heart 2.9 x 2.9 x 2.7 Sc.I.	\$39.00/ea
-----------	---	-------------------

Photo Box Urn **JorVet**

BUY NOW

Introducing an expanded range of designer style pet urns to offer veterinarian clients a wider range of choices for cremation urns. All urns have a threaded screw on lid for security.

Birch

JOR316PBS	Birch Finish MDF, Small	\$30.50/ea
JOR316PBM	Birch Finish MDF, Medium	\$37.50/ea
JOR316PBL	Birch Finish MDF, Large	\$44.00/ea

Cherry

JOR316PCS	Cherry Finish MDF, Small	\$39.00/ea
JOR316PCM	Cherry Finish MDF, Medium	\$35.00/ea
JOR316PCL	Cherry Finish MDF, Large	\$38.00/ea

Black

JOR316PFS	Black Finish MDF, Small	\$38.00/ea
JOR316PFM	Black Finish MDF, Medium	\$37.50/ea
JOR316PFL	Black Finish MDF, Large	\$38.00/ea



Cotton & Gauze Products



Gauze Sponges

Non-Woven Gauze Sponges

Compare to NU-GAUZE or Versalon and SAVE! Same properties and packaging as NU-GAUZE and Versalon for LESS! Order Today!

PK224	2" X 2" 4-Ply 200/Pkg	\$1.29/pk
PK334	3" X 3" 4-Ply 200/Pkg	\$2.99/pk
PK444	4" X 4" 4-Ply 200/Pkg	\$3.25/pk

By The Case

224CS	2" X 2" 4-Ply 8000/cs	\$49.00/cs
334CS	3" X 3" 4-Ply 4000/cs	\$39.00/cs
444CS	4" X 4" 4-Ply 2000/cs	\$39.00/cs



Gauze Sponges

High quality, non-sterile gauze made of lint free cotton with no raw edges or loose threads. High absorbency, low linting, and costs less than the leading brands. Compare to any leading brand of sponge.



PK208	2" X 2" 8-Ply 200/Pkg	\$1.99/pk
PK212	2" X 2" 12-Ply 200/Pkg	\$2.29/pk
PK308	3" X 3" 8-Ply 200/Pkg	\$2.99/pk
PK312	3" X 3" 12-Ply 200/Pkg	\$3.49/pk
PK408	4" X 4" 8-Ply 200/Pkg	\$3.99/pk
PK412	4" X 4" 12-Ply 200/Pkg	\$5.95/pk
PK416	4" X 4" 16-Ply 200/Pkg	\$6.95/pk



By The Case

208C	2" x 2" 8-Ply 5000/cs	\$39.75/cs
212C	2" X 2" 12-Ply 8000/cs	\$79.60/cs
308C	3" X 3" 8-Ply 4000/cs	\$49.00/cs
312C	3" x 3" 12-Ply 4000/cs	\$59.00/cs
408C	4" x 4" 8-Ply 4000/cs	\$64.00/cs
412C	4" X 4" 12-Ply 2000/cs	\$49.50/cs



Jorvet Non-Woven Sponge Gauze

Synthetic rayon and polyester non-woven fabric. These sponges are lint free, superior in strength and 50 percent more absorbable than cotton sponges.

JOR570A	2" x 2", 4-ply. 200/pk, 40 pk/case	\$108.00/cs
JOR570B	3" x 3", 4-ply. 200/pk, 20 pk/case	\$86.00/cs
JOR570C	4" x 4", 4-ply. 200/pk, 20 pk/case	\$111.00/cs

Sterile Gauze



Made from the finest USP Type VII gauze. Packed in Sterile 2's.



208STRL	2" X 2", 8Ply 2'S, 50pk/box	\$2.99/pk
208STRL-CS	2" X 2" 8Py 2'S 3000/cs	\$49.99/cs
312STRL	3" X 3" 12Ply 2'S 25Pk	\$2.99/pk 10+\$1.99/ea
408STRL	4" X 4" 8Ply 2'S 25Pk	\$4.99/box



Jorvet Fluff Dressing Bandage

A 6-ply 100 percent cotton gauze that is very soft with fluff dried heavy-ply for cushioning and protection

JOR573	4 1/2", 12/bag, 4 bags/cs	\$75.00/cs
--------	---------------------------	------------



Jorvet Self Adherent Bandage

2-ply high quality cotton gauze that is excellent for general bandaging. **Jorvet**

JOR572A	2", 2/bag, 8 bags/case	\$43.50/cs
JOR572B	3", 12/bag, 8 bags/case	\$53.00/cs
JOR572C	4", 12/bag, 8 bags/case	\$63.00/cs
JOR572D	6", 6/bag, 8 bags/case	\$49.00/cs

Jorvet Stretch Conforming Gauze Bandage



The unique bandage pattern allows controlled stretch compared to cling gauze. It molds to any body shape to allow freedom of movement. It is also soft and light weight.

JOR571A	1" x 4.1 yds. 12/pk, 8 pk/case	\$22.50/cs
JOR571B	2" x 4.1 yds. 12/pk, 8 pk/case.	\$39.00/cs
JOR571C	3" x 4.1 yds. 12/pk, 8 pk/case.	\$50.00/cs
JOR571D	4" x 4.1 yds. 12/pk, 8 pk/case.	\$56.00/cs

Cotton & Gauze Products



Lap Sponge & Gauze Bandage Rolls

Lap Sponge Sterile

BUY NOW

Highly Absorbent Lap Sponges are X-Ray Detectable. These latex-free lap sponges are pre washed and de-linted for problem-free use.

LAP1212	12" X 12" 5/Pk	\$2.50/pk
LAP1212CS	12" X 12" 200/cs	\$57.00/cs
LAP1818	18" X 18" 5/Pk	\$3.00/pk
LAP1818CS	18" X 18" 200/cs	\$69.00/cs



Lap Sponge Non-sterile

Highly Absorbent Lap Sponges are X-Ray Detectable. Made up of mostly 18" x 18", 4" x 18" and 8" x 36" sizes, these latex-free lap sponges are pre washed and de-linted for problem-free use.

LAP-BULK	200/cs mixed sizes	\$29.95/cs
----------	--------------------	------------

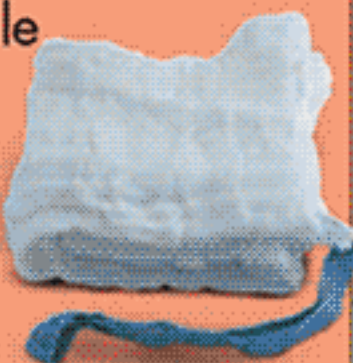

Jorvet Laparotomy Sponges

Pre-washed 8-ply lap sponges, radio-opaque with loops. Useful in retaining body structures during deep abdominal surgery.

JOR490A	18" x 18", 5 pk, Non-Sterile	\$3.75/pk
JOR490AS	18" x 18", 2 pack, Sterile	\$4.05/pk
JOR490B	4" x 18", 5pk, Non-Sterile	\$2.49/pk
JOR490BS	4" x 18", 2 pack, Sterile	\$4.56/pk



Non-Sterile Stretch Gauze Rolls

Stretches and conforms to body contours without drooping or falling off. It's high absorbency helps maintain a drier wound site.

By the Bag

492Z	2" X 4.1 yds 12/Bg	\$2.75/bg
493Z	3" X 4.1 yds 12/Bg	\$3.75/bg
494Z	4" X 4.1 yds 12/Bg	\$4.75/bg
496Z	6" X 4.1 yds 6/Bg	\$3.75/bg

By Bulk

492BULK	2" 12/bg 8/bg/cs 96/cs	\$12.95/cs
493BULK	3" 12/bg 8/bg/cs 96/cs	\$15.95/cs
494BULK	4" 12/bg 8/bg/cs 96/cs	\$18.95/cs
496BULK	6" 6/bg 8/bg/cs 48/cs	\$15.95/cs

BUY NOW

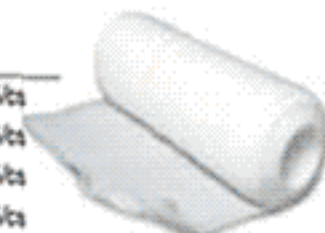

Sterile Stretch Gauze Rolls

Stretches and conforms to body contours without drooping or falling off. It's high absorbency helps maintain a drier wound site.

492STRL	2" X 2.1 yds Each	\$0.35/ea
493STRL	3" X 2.1 yds Each	\$0.45/ea
494STRL	4" X 2.1 yds Each	\$0.45/ea
496STRL	6" X 2.1 yds Each	\$0.85/ea



BUY NOW

Gauze Bandage Roll

Non-sterile, single ply bandage rolls consisting of 100% mesh gauze. 10 yards in length. 12 per bag.

1350-1	1" X 10 yds 12/Bag	\$3.99/bg
1350-2	2" X 10 yds 12/Bag	\$7.49/bg
1350-3	3" X 10 yds 12/Bag	\$11.49/bg



BUY NOW

JorVet Gauze Roll Bandage

This single-ply cotton gauze bandage conforms to a wide range of uses around the clinic besides the normal wound bandaging. Thick 28 x 24 mesh covered in paper. 12 rolls/pk.

Applications:

- Wrapping over primary dressings
- Simple muzzles
- Tying endotracheal tubes during intubation
- Surgical tie downs

BUY NOW



JOR888	1", 10 yds., 12 rolls/pk	\$4.32/dz
JOR888A	2", 10 yds., 12 rolls/pk	\$8.40/dz
JOR888B	3", 10 yds., 12 rolls/pk	\$12.20/dz
JOR888C	4", 10 yds., 12 rolls/pk	\$12.20/dz

Kerlix Type Gauze Rolls

BUY NOW

6-ply, 100% cotton. Unique crimped, open-weave design means superior absorbency and cushioning. Gently stretches and conforms to body contours. Used as either a primary or secondary dressing. 4" x 4 yard Kerlix-type rolls. Available in sterile and non-sterile packages.

BULKEE-NS	4" X 4 yds Non-Sterile	\$0.55/ea	100+/\$0.50ea
BULKEE-STRL	4" X 4 yds Non-Sterile	\$0.85/ea	100+/\$0.85ea



13822 WEST BOULTON BLVD. METTAWA, IL 60045

WWW.SHOPMEDVET.COM

Phone 800-544-7521

1772

Fax 800-204-2177

Cotton & Gauze Products



Cotton; Rolls, Balls, Bandaging & Brown Rolls

Cotton Roll

BUY NOW



The versatility of roll cotton is unmatched. This one pound Non-Sterile roll is made from 100% cotton. It can be used for facial, nail, skin care applications, swabs, padding, leg wraps and many other uses. The highest quality cotton rolls available for applications where absorbency, flexibility, cleanliness, and softness are key requirements.

2661 1 Pound \$3.50/roll



Jorvet Cotton Roll

Great for wound care and padding. Bright white, seed-free long stem cotton. Layers in roll separated by blue paper.

JOR197 Outer white poly bag. \$4.95/ea



JorVet

#JOR197

Cotton Roll

BUY NOW

This one pound Sterile roll is made from 100% cotton. It can be used for facial, nail, skin care applications, swabs, padding, leg wraps and many other uses. The highest quality cotton rolls available for applications where sterility, absorbency, flexibility, cleanliness, and softness are key requirements.

8401W 1 pound sterile \$8.99/roll



Brown Gauze Rolls

Heavy type brown gauze roll 5 yards in length. 12 per bag

By The Bag

BG3 3" X 5 yds 12/Bg \$3.99/bg
BG6 6" x 5 yds 12/Bg \$7.99/bg

By The Case

BG3CS 3", 96/case \$28.00/cs
BG6CS 6", 96/case \$60.00/cs



Jorvet Brown "Cling" Gauze

Our brown "cling" gauze is 100 percent pure cotton and comes in fine 24 x 17 mesh.

BUY NOW

JOR192A 3" x 5 yds., dozen/pk. \$6.30/dzv
JOR192B 6" x 5 yds., dozen/pk. \$10.35/dzv

JorVet



Jorvet Cotton Bandage Sheeting

Popular "sheet cotton" material constructed of thin sheet spun cotton fibers. Highly absorbent material that offers excellent protection at an affordable price. Packaged in two forms. (not pictured)

JOR871 30" x 36" Rolled and packaged in poly bag. 12 sheets/bag, 20 bags. \$120.00/ea
JOR871B 30" x 28" Bulk in large flat bale. 240/bale. \$120.00/ea

FREE

AMEX GIFT CARD

with required purchase, certain restrictions apply.
See Inside Cover for Details

Non-Sterile Cotton Balls

BUY NOW



Oasis

as low as

\$15.59/cs
Medium

COTBALL Medium, 4000/cs \$15.59/cs
COTBALL-LG Large, 2000/cs \$19.95/cs

Jorvet Absorbent Cotton Balls

Medium fluffy quality cotton. JorVet

JOR850 2000/bag. \$9.75

BUY NOW

Gloves

Exam & Latex

Vinyl Gloves

These top-quality, non-sterile gloves are at a price that can't be beat by anyone! 100/bx. Various manufacturers.

VNVL-S	Small 100/bx	\$3.99/bx
VNVL-M	Medium 100/bx	\$3.99/bx
VNVL-L	Large 100/bx	\$3.99/bx
VNVL-XL	X-Large 100/bx	\$3.99/bx

\$3.99/bx



BUY NOW

Micro-Touch® Nextstep Powder-Free Exam Gloves

BUY NOW

Glove is powder-free to help eliminate powder-related complications and sensitivity. Excellent tactile sensitivity, fit, and feel. Micro-Touch® is a registered trademark of Ansell.

- Textured to enhance grip
- Ambidextrous.

3201	Small, 100/bx	\$8.99/bx	10+\$8.29/bx
3202	Medium, 100/bx	\$8.99/bx	10+\$8.29/bx
3203	Large, 100/bx	\$8.99/bx	10+\$8.29/bx
3204	X-Large, 100/bx	\$8.99/bx	10+\$8.29/bx

Ansell



\$8.99/bx

Powdered Latex Gloves

BUY NOW

Non-Sterile, lightly-powdered. Top-quality 100 ambidextrous gloves per box. Various manufacturers.

AHSXS	X-Small, 100/bx	\$5.29/bx
AHSS	Small 100/bx	\$5.29/bx
AHSM	Medium 100/bx	\$5.29/bx
AHSL	Large 100/bx	\$5.29/bx
AHSXL	X-Large 100/bx	\$5.29/bx

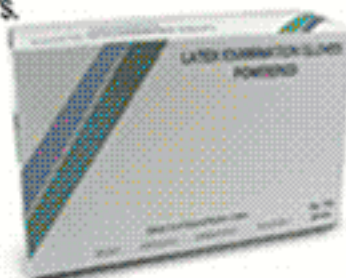

Powder-Free Latex Gloves

Non-Sterile, powder-free. Top-quality, 100 ambidextrous gloves per box. Various manufacturers.

AHSPFS	Small 100/bx	\$6.99/bx
AHSPFM	Medium 100/bx	\$6.99/bx
AHSPFL	Large 100/bx	\$6.99/bx
AHSPFXL	X-Large 100/bx	\$6.99/bx



BUY NOW

Micro-Touch® Smooth Nitrile Exam Gloves

Latex-Free, Powder-Free Exam gloves help eliminate powder-related complications and sensitivity. 100% Nitrile, does not contain natural rubber latex. Excellent chemical resistance. Color is blue. Micro-Touch® is a registered trademark of Ansell.

6034101	Small, 100/bx	\$10.49/bx	10+\$9.49/bx
6034102	Medium, 100/bx	\$10.49/bx	10+\$9.49/bx
6034103	Large, 100/bx	\$10.49/bx	10+\$9.49/bx
6034104	X-Large, 100/bx	\$10.49/bx	10+\$9.49/bx



latexfree

As low as

10+\$9.49/bx

BUY NOW

Nitrile Gloves

BUY NOW

Non-sterile, top quality latex-free nitrile gloves. 100 ambidextrous gloves per box. No choice of color. No choice of powdered or powder-free. Various manufacturers.

NITRILE-XS	Nitrile X-Small 100/bx	\$6.99/bx
NITRILE-S	Nitrile Small 100/bx	\$6.99/bx
NITRILE-M	Nitrile Medium 100/bx	\$6.99/bx
NITRILE-L	Nitrile Large 100/bx	\$6.99/bx
NITRILE-XL	Nitrile X-Large 100/bx	\$6.99/bx



latexfree

Pink Gloves

BUY NOW

Medline's Generation Pink latex-free, patented third-generation vinyl exam gloves have the comfort, barrier protection and price you love. When you choose Generation Pink gloves, you're helping Medline support the National Breast Cancer Foundation. Large

PNK6076	Large, 100/bx	\$6.99/bx
PNK6074	Small, 100/bx	\$6.99/bx
PNK6075	Medium, 100/bx	\$6.99/bx
PNK6077	X-Large, 100/bx	\$6.99/bx



NOW AVAILABLE

A portion of the proceeds from the PINK GLOVES sales will be donated to National Breast Cancer Foundation to fund free mammograms for underserved women.

Gloves

Nitrile & Surgical

Powder Free Surgeon Glove

Sterile, powder-free. Top-quality 50 pair per box. Various manufacturers.

SG5.5-PF	5.5	40 pr/bx	\$27.95/bx
SG6-PF	6	40 pr/bx	\$27.95/bx
SG6.5-PF	6.5	40 pr/bx	\$27.95/bx
SG7-PF	7	40 pr/bx	\$27.95/bx
SG8-PF	8	40 pr/bx	\$27.95/bx
SG8.5-PF	8.5	40 pr/bx	\$27.95/bx
SG9-PF	9	40 pr/bx	\$27.95/bx



BUY NOW

Powdered Surgeon Glove

Sterile, powdered. Top-quality 40-50 pair per box. Various manufacturers.

SG5.5	5.5	40 pr/bx	\$21.95/bx
SG6	6	40 pr/bx	\$21.95/bx
SG6.5	6.5	40 pr/bx	\$21.95/bx
SG7	7	40 pr/bx	\$21.95/bx
SG7.5	7.5	40 pr/bx	\$21.95/bx
SG8	8	40 pr/bx	\$21.95/bx
SG8.5	8.5	40 pr/bx	\$21.95/bx
SG9	9	40 pr/bx	\$21.95/bx



BUY NOW

Aloetouch® Exam Gloves



BUY NOW

Aloetouch® are top-quality powder-free gloves with the benefits of aloe vera. Aloe vera naturally helps moisturize and soothe dry, chapped hands. These strong, durable, natural rubber latex gloves provide superior barrier protection and are powder-free to minimize skin irritation. The fully textured surface gives you a sure grip on instruments and dressings. Ideal for anyone who changes gloves frequently, washes hands repeatedly, or wears gloves for extended periods of time. Aloetouch® is a registered trademark of Medline.

ALOE-S	Small 100/Box	\$8.99/bx
ALOE-M	Medium 100/Box	\$8.99/bx
ALOE-L	Large 100/Box	\$8.99/bx
ALOE-XL	X-Large 100/Box	\$8.99/bx

\$8.99/bx



Sensi-Touch® Surgical Gloves

Sensi-Touch® powdered surgical gloves are 12 inches in length with a straight, reinforced cuff for extra coverage and protection on the forearm. Sensi-Touch® is a registered trademark of Ansell.

- Natural Rubber Latex
- Anti-Slip Smooth finish
- Sterile.



BUY NOW

7821	Size 5.5	50 pr/bx	\$26.49/bx	4+\$24.49/bx
7822	Size 6	50 pr/bx	\$26.49/bx	4+\$24.49/bx
7823	Size 6.5	50 pr/bx	\$26.49/bx	4+\$24.49/bx
7824	Size 7	50 pr/bx	\$26.49/bx	4+\$24.49/bx
7825	Size 7.5	50 pr/bx	\$26.49/bx	4+\$24.49/bx
7826	Size 8	50 pr/bx	\$26.49/bx	4+\$24.49/bx
7827	Size 8.5	50 pr/bx	\$26.49/bx	4+\$24.49/bx
7828	Size 9	50 pr/bx	\$26.49/bx	4+\$24.49/bx

Ansell

As low as
\$26.49/bx

Micro-Touch® Surgeon Gloves

These sterile, latex, surgeons gloves feature a natural contour design and longer beaded cuffs for added protection. Fingers are curved and tapered to provide greater comfort. Gloves come with 50 pairs box.



BUY NOW

JJ5860	Size 6	50 pr/bx	\$39.95/bx	4+\$36.95/bx
JJ5865	Size 6.5	50 pr/bx	\$39.95/bx	4+\$36.95/bx
JJ5870	Size 7	50 pr/bx	\$39.95/bx	4+\$36.95/bx
JJ5875	Size 7.5	50 pr/bx	\$39.95/bx	4+\$36.95/bx
JJ5880	Size 8	50 pr/bx	\$39.95/bx	4+\$36.95/bx
JJ5885	Size 8.5	50 pr/bx	\$39.95/bx	4+\$36.95/bx
JJ5890	Size 9	50 pr/bx	\$39.95/bx	4+\$36.95/bx

Perry Original Surgeon Gloves

Perry Style 42 powdered surgical gloves provide uncompromising quality and durability. Natural Rubber latex, anti-slip and smooth finish Sterile



BUY NOW

5711100	Size 5.5	50 pr/bx	\$28.49/bx	4+\$25.49/bx
5711101	Size 6	50 pr/bx	\$28.49/bx	4+\$25.49/bx
5711102	Size 6.5	50 pr/bx	\$28.49/bx	4+\$25.49/bx
5711103	Size 7	50 pr/bx	\$28.49/bx	4+\$25.49/bx
5711104	Size 7.5	50 pr/bx	\$28.49/bx	4+\$25.49/bx
5711105	Size 8	50 pr/bx	\$28.49/bx	4+\$25.49/bx
5711106	Size 8.5	50 pr/bx	\$28.49/bx	4+\$25.49/bx
5711107	Size 9	50 pr/bx	\$28.49/bx	4+\$25.49/bx

Surgical & Glove Dispensers

Neolon Surgical Glove

BUY NOW

Neolon 2G PF Neoprene Surgical Gloves: New proprietary neoprene formulation, which is softer, more elastic and comfortable vs. traditional neoprene gloves. The lightly textured grip provides more sensitivity. Reinforced cuff reduces cuff tearing during donning and in use. ARC (anti-roll down cuff) was designed to reduce cuff roll down common with most powder-free gloves. The inner polymer coating allows easy donning both with damp and dry hands. Brown/tan color reduces the glare from the lights in the O.R. 100/case

MDS207060	Size 6.0	\$201.55/cs
MDS207065	Size 6.5	\$201.55/cs
MDS207070	Size 7.0	\$201.55/cs
MDS207075	Size 7.5	\$201.55/cs
MDS207080	Size 8.0	\$201.55/cs
MDS207085	Size 8.5	\$201.55/cs
MDS207090	Size 9.0	\$201.55/cs



Elbow Glove

BUY NOW

Top Quality. 100 per box. One size fits all.
AHSELG 03X240X530mm 100/Box \$8.00/bx

Shoulder Length Gloves

Top Quality. 100 per box. One size fits all.
AHSSLG .03 X 240 X 830mm 100/BOX

\$11.00/ea

Danish Disposable Gloves

"Krutex" Disposal Gloves, OB sleeve these gloves were developed for small hands for a tighter fit. Amber.

JOR100D	100/box, Amber	\$21.00/bx
JOR100DS	100/box, Amber	\$30.00/bx

Vet-R-Sem Gloves

This very popular glove fits your hand with no overlapping finger ends. Seams are very low and stretch well. The veterinarian's choice for sensitivity and strength. 1.35ml. Extra long: 35". Clear. 100/zip lock bag.

JOR100	100/zip lock bag	\$20.25/bg
--------	------------------	------------

JorVet



BUY NOW



Acrylic Exam Glove Dispenser

Every exam room needs these wall-mounted glove dispensers. They free up counter space and give a clean, professional image. The dispenser fits virtually all brands of latex gloves. Includes all mounting hardware.

JOR876D	Single box, Horizontal	\$46.00/ea
JOR876R	Single box, Vertical	\$46.00/ea
JOR876S	Double box, Horizontal	\$49.00/ea
JOR876X	Triple box, Horizontal	\$60.00/ea

BUY NOW



Exam Glove Box Holder

Wall mount your exam gloves out of the way, but still have easy access. Attractive epoxy coated steel wire racks will hold one single box of all major brands of exam gloves. Complete with mounting screws.

JOR876	Holds 1 Box, 102mm x 140mm x 208mm	\$24.00/ea
JOR876A	Holds 3 Boxes, 250mm x 96mm x 432mm	\$44.40/ea

BUY NOW



Glove Dispenser



BUY NOW



Available in vinyl-coated steel, this sturdy dispenser holds one box of gloves horizontally or two boxes vertically. See-through construction allows easy identification of glove sizes. 10 3/8"W x 4"H x 3 1/2"D.

GLOVEHOLDER	\$9.95/ea	3+ \$8.95/ea
-------------	-----------	--------------

SURGICAL APPAREL

- GOWNS
- BARRIER, SURGEONS,
- DISPOSABLE, POLYETHYLENE
- SHOE COVERS
- GOGGLES/

CHECKOUT SURGICAL AND EXAM SECTION IN THIS CATALOG



Gloves

Animal Handling

Warden Pro Handling Gloves

Developed to prevent the intrusion of sharp objects while handling dogs, cats, snakes, or small wild animals. Allows maximum dexterity. This glove is not bite-proof.

BUY NOW

WARDENPRO Length: 23 inches, Palomino leather, Dupont Kevlar felt lining. \$134.95/pr

Warden Handling Gloves

Developed for the gentle handling of dogs, cats, snakes, small wild animals. Length: 23 inches, Palomino leather, heavy felt lining. This glove is not bite-proof.

BUY NOW

WARDEN-M Medium 23 inches \$109.95/pr
WARDEN-L Ladies, 23 inches \$109.95/pr

Jorvet Gauntlet Gloves

Penetration protection gloves, plus good dexterity. These gloves are heavy-duty cowhide plus extra-long suede gauntlets. Fully-lined with Kevlar felt. Perfect for felines or birds. This glove is not bite-proof.

BUY NOW

JOR791 Small, Pair 18" \$143.00/pr
JOR791M Large, Pair 23" \$154.00/pr

Grooming Gloves

These cat grooming gloves are sold by the pair. Specifically designed protrusions on fingers and palms cause needed friction to pick up loose hair while stroking your pet. Machine washable.

BUY NOW

CPH116 Cat 1 Pair \$3.00/pr

Jorvet Cat/Wildlife Gloves



Cat and Wildlife Gloves. Designed for maximum dexterity and feel (often missing in protective gloves). Provides a very high level of penetration protection through a combination of special materials. The hand features high quality top grain leather completely lined with new Spectra, which is ten times stronger than Kevlar. The gauntlet's double layer of Dupont Kevlar knit resists sharp teeth, talons and claws, covering up past the elbow. In addition to penetration resistance, the outstanding feature is you hardly know you have them on. Perfect for handling creatures that can not inflict crushing type bites. Excellent for cats, birds, and small animals. These gloves are NOT bite proof. Please use with caution.

JOR872 Small \$115.00/pr
JOR872A Medium \$115.00/pr
JOR872B Large \$116.00/pr



Magnum Handling Gloves

Developed with steel safety mini-bars clinched to the back and front of hand portion of glove to provide the maximum in protection in high hazard areas from puncture wounds. Cuff is double-thick palomino leather. This glove is not bite-proof.

BUY NOW

MAGNUM Length: 23 inches, Palomino leather, heavy felt lining. \$159.95/pr

Animal Gauntlet Gloves

Ideal for use against large, dangerous dogs and other animals with crushing bites. Heavily padded throughout, but if not required, simply remove the outer layer. Inner glove features soft elk hide for dexterity plus padded gauntlet. This glove offers the maximum crushing protection. This glove is not bite proof.

BUY NOW

JOR874 Small, Pair \$210.00/ea
JOR874A Medium, Pair \$210.00/ea
JOR874B Large, Pair \$210.00/ea

Trapper Handling Gloves

Similar design features as the Warden but with an extra wide bell cuff for use over heavy-clothing or foul weather-gear. An easy-to-use nylon take up strap keeps the cuff securely in place. This glove is not bite-proof.

TRAPPER Length: 22 inches, Palomino leather, Dupont Kevlar felt lining. \$139.50/pr

Leather Restraint Gloves

Handling fractious animals can be made safer and easier with heavy-duty gloves. Light brown suede leather gloves have a padded lining for comfort and safety. Covers the forearm for real protection. One size fits all. 15 1/2" long. Not bite proof.

BUY NOW

JOR455 Pair \$86.00/pr

Jorvet Resistor Restraint Gloves



Spectra lined for maximum penetration protection, yet has the dexterity of a driving glove. The gauntlet is extremely well padded and features "trauma plates" to protect against hard bites over a wide area. The back of the hand's shield protects against crushing bites but does not interfere with gripping. Ideal for working with dogs, cats and exotics. The best all around glove. Attractive black leather.

JOR873 Small \$105.00/pr
JOR873A Medium \$108.00/pr
JOR873B Large \$132.00/pr



Wound Care Products

Cohesive Tape & Elastic Bandages

PowerFlex® Tape

PowerFlex®

PowerFlex® is a patented cohesive flexible bandage that eliminates the need to use pre-wrap, pressure sensitive elastic tear tape, and spray adhesives. PowerFlex® can be applied directly to the skin and provides 23 lbs. of tensile strength. PowerFlex® will not slip from sweat.

PowerFlex® is a registered trademark of Andover Coated Products.

POWFLEX4 4" X 5 yds \$2.45/ea 18+\$2.10/ea



Paw Print Petflex® Tape

BUY NOW

PetFlex®

A softer, stronger bandage, PetFlex® provides controlled compression with nonslip support to secure and protect primary dressings from dirt and moisture. It is a durable bandage that provides easy application (no need for scissors easy-to-hand tear), will not shred and is resistant to sweat and water. PetFlex® is an easy to clean, reusable fabric-based cohesive bandage that is more than double the strength of Vetrap®. All rolls are 5 yards in length.

No choice of colors. PetFlex® is a registered trademark of Andover Coated products.

PAWFLEX2 2" x 5 yards \$1.65/ea 36+\$1.35/ea
 PAWFLEX3 3" x 5 yards \$2.10/ea 36+\$1.80/ea
 PAWFLEX4 4" x 5 yards \$2.20/ea 36+\$1.90/ea



BUY NOW

Co-Flex® Tape

BUY NOW

Assorted colors, adheres to itself requiring no clips or fasteners, will not stick to hair. Individually shrink wrapped. No choice of colors. All rolls are 5 yards in length. Contains Latex. Co-Flex® is a registered trademark of Andover Coated Products.

COFLEX1 1" X 5 yds \$0.90/ea 30+\$0.79/ea
 COFLEX2 2" X 5 yds \$1.40/ea 36+\$1.09/ea
 COFLEX3 3" X 5 yds \$1.80/ea 24+\$1.39/ea
 COFLEX4 4" X 5 yds \$1.88/ea 18+\$1.49/ea
 COFLEX6 6" X 5 yds \$3.70/ea 12+\$3.29/ea



Elastic Bandage

Oasis

Economical and reusable, elastic bandages offer balanced stretch and compression. Made of rubber-reinforced high-quality cotton yarn, these bandages can be laundered and sterilized.



By The Roll

EB2 2", 5 Yards Stretched Length \$0.30/ea
 EB3 3", 5 Yards Stretched Length \$0.50/ea
 EB4 4", 5 Yards Stretched Length \$0.55/ea
 EB6 6", 5 Yards Stretched Length \$0.75/ea

By The Bag

REB2 2" ACE-TYPE, 12/BG \$3.00/bg
 REB3 3" ACE-TYPE, 12/BAG \$4.95/bg
 REB4 4" ACE-TYPE, 12/BAG \$5.95/bg
 REB6 6" ACE-TYPE, 12/BAG \$8.95/bg



Oasis Cohesive Tape

BUY NOW

Flexible cohesive bandage that adheres to itself and does not require clips or fasteners, and it will not stick to hair. Individually wrapped and is quick and easy to remove. No choice of colors.

OF1 1" x 5 yds \$0.75/ea 30+\$0.50/ea
 OF2 2" x 5 yds \$1.15/ea 36+\$0.80/ea
 OF3 3" x 5 yds \$1.45/ea 24+\$0.90/ea
 OF4 4" x 5 yds \$1.50/ea 18+\$1.00/ea
 OF6 6" x 5 yds \$3.00/ea 12+\$2.00/ea



Oasis

Coban® Tape

BUY NOW

This self-adherent, non-adhesive elastic wrap, secures, protects, compresses, and supports. Maintains uniform compression. Won't slip or loosen. No need for clips or pins. Doesn't stick to hair or skin. Lightweight, porous, and comfortable. Moisture resistant. All rolls are 5 yards in length. No choice of colors. Coban® is a registered trademark of 3M.

1581 1" X 5 yds \$1.50/ea
 1582 2" X 5 yds \$1.99/ea
 1583 3" X 5 yds \$2.50/ea
 1584 4" X 5 yds \$3.00/ea
 1586 6" X 5 yds \$3.50/ea



Petflex® Tape

BUY NOW

A softer, stronger bandage, PetFlex® provides controlled compression with nonslip support to secure and protect primary dressings from dirt and moisture. It is a durable bandage that provides easy application (no need for scissors easy-to-hand tear), will not shred and is resistant to sweat and water. PetFlex® is an easy to clean, reusable fabric-based cohesive bandage that is more than double the strength of Vetrap®. All rolls are 5 yards in length.

No choice of colors. Petflex® is a registered trademark of Andover Coated products.

PETFLEX1 1" X 5 yds \$1.00/ea 30+\$0.80/ea
 PETFLEX2 2" X 5 yds \$1.55/ea 36+\$1.25/ea
 PETFLEX3 3" X 5 yds \$2.00/ea 24+\$1.70/ea
 PETFLEX4 4" X 5 yds \$2.10/ea 18+\$1.80/ea



Jorvet Elastic Adhesive Bandage

BUY NOW

Similar design to Elastikon® from J & J but at considerable savings. This stretchable tan woven fabric is a very familiar looking tape with red centering line.

JOR1030A 2", 6pk, 5 yds. L \$16.80/pk
 JOR1030B 3", 4pk, 5 yds. L \$16.80/pk
 JOR1030C 4", 6pk 5 yds. L \$33.00/pk



Wound Care Products

Tape; Porous, Elastic, Micropore & Surgical Adhesive



Porous Tape

BUY NOW

Oasis Porous Tape



Oasis Porous Tape is one of the strongest tapes you can find. We pride ourselves in the quality of this tape and trust you will find out why we are excited to offer it to you with considerable savings over similar products. Try a roll. You will never use any other tape again! All rolls are 10 yards in length.



\$10.95/bx

PT5	1/2" X 10 yds 24/bx	\$10.95/bx
PT1	1" X 10 yds 12/bx	\$10.95/bx
PT1.5	1.5" X 10 yds 6/bx	\$10.95/bx
PT2	2" X 10 yds 6/bx	\$10.95/bx

Zonas[®] Porous Tape

Strong, yet easy to tear cloth tape. Reliable immobilization of sprains. Use when rigid strapping tape is required. 10 yards in length. Zonas[®] is a registered trademark of Johnson and Johnson.



JJ5100	2" X 10 yds 6/bx	\$16.99/bx
JJ5103	1/2" X 10 yds 24/bx	\$16.99/bx
JJ5104	1" X 10 yds 12/bx	\$16.99/bx
JJ5107	3" X 10 yds 4/bx	\$16.99/bx



Elastic Tape

BUY NOW



Oasis Elastic Adhesive Tape

Oasis Elastic Adhesive Tape Provides Even Compression and Firm Support. Cotton elastic cloth tape features a strong rubber-based adhesive to permit flexibility of joints without the loosening of tape. Ideal for dynamic-pressure dressings requiring elasticity. Molds to body contours.

By The Roll

EA1-EACH	1" X 5 yds	\$1.49/rl
EA2-EACH	2" X 5 yds	\$2.49/rl
EA3-EACH	3" X 5 yds	\$3.49/rl
EA4-EACH	4" X 5 yds	\$4.49/rl

By The Box

EA1	1" X 5 yds 12/bx	\$12.99/bx
EA2	2" X 5 yds 6/bx	\$12.99/bx
EA3	3" X 5 yds 4/bx	\$12.99/bx
EA4	4" X 5 yds 6/bx	\$24.99/bx



Starting At

\$1.49/rl

Elastikon[®] Tape

BUY NOW

Helps to maintain constant controlled pressure. It comfortably ensures a custom fit around hard to tape areas. Excellent adhesion. Unsurpassed strength. All rolls are 5 yards in length stretched. Elastikon[®] is a registered trademark of Johnson & Johnson.

JJ5172	1" X 2.5 yds 12/bx	\$21.99/bx
JJ5174	2" X 2.5 yds 6/bx	\$21.99/bx
JJ5175	3" X 2.5 yds 4/bx	\$21.99/bx
JJ5177	4" X 2.5 yds 6/bx	\$42.99/bx



Micropore[®] Tape

BUY NOW

Get excellent breathability and comfort with lightweight Micropore paper tape. It holds fast even when wet and won't harm delicate wound areas. Hypoallergenic. Micropore[®] is a registered trademark of 3M.

1530-0	1/2" X 10 yds 24/bx	\$8.99/bx
1530-1	1" X 10 yds 12/bx	\$8.99/bx
1530-2	2" X 10 yds 6/bx	\$8.99/bx
1530-3	3" X 10 yds 4/bx	\$8.99/bx



\$8.99/bx

Transpore[®] Tape

BUY NOW

Perforated for easy tearing and porous for greater breathability. Transpore conforms and stretches to accommodate body movement. Because it's clear it allows regular monitoring. Transpore[®] is a registered trademark of Johnson & Johnson.

1527-0	1/2" X 10 yds 24/bx	\$15.99/bx
1527-1	1" X 10 yds 12/bx	\$15.99/bx
1527-2	2" X 10 yds 6/bx	\$15.99/bx
1527-3	3" X 10 yds 4/bx	\$15.99/bx



Eyepad

BUY NOW

Eye Pads: These sterile Eye Pads are made with a soft non-woven cover, over an absorbent cotton filler. Compressed edges help reduce lining. 1-5/8" x 2-5/8".

EYEPAD	Sterile 50/bg	\$5.99/bx
--------	---------------	-----------



Jorvet Surgical Adhesive Tape

High quality "athletic" white porous cloth tape that can be torn easily. Priced at considerable savings.

JOR820AN	1" W. x 10 yds L. 12 rolls/bx	\$17.20/bx
JOR820BN	2" W. x 10 yds L. 6 rolls/bx	\$17.20/bx
JOR820DN	3" W. x 10 yds L. 6 rolls/bx	\$27.20/bx
JOR820E	3" W. x 10 yds L. 6 rolls/bx	\$13.00/bx
JOR820EN	4" W. x 10 yds L. 6 rolls/bx	\$37.60/bx



BUY NOW

Find that instrument you need in our Instrument Section



13822 WEST BOULTON BLVD. METAWA, IL 60045

Phone 800-544-7521

17/9

WWW.SHOPMEDVET.COM

Fax 800-204-2177

Wound Care Products



Dressing, Intracell & Silver Sulfadiazine

Non-Adherent Dressing

The non-adherent pad is a unitized dressing with an absorbent inner layer of fiber that is laminated between two thin, highly porous polyethylene net facing layers. Designed specifically to help prevent over hydration and maceration at the wound site and surrounding skin, the pad allows for a shorter healing time. This dressing may be used with or without a secondary dressing, depending on the need for additional protection or absorption. It will not stick to the wound! Compare and Save!! These are exactly the same as top name brands with a lower price.



NA2X3	2" X 3" 100/bx	\$5.49/bx
NA2X3-CS1	2" X 3" 100/bx 1200/C	\$49.00/cs
NA3X4	3" X 4" 100/bx	\$8.99/bx
NA3X4-CS	3" X 4" 100/bx 1200/C	\$79.00/cs

as low as
\$5.49/bx

BUY NOW

BSN Specialist Cast Padding

Cotton and Rayon Blend for excellent absorption. Micropore design results in conformability, protection and ease of application. Provides exceptional under-cast protection. Excellent conformability, contours smoothly over prominences to provide a more comfortable healing process.



9062	2" x 4yd, 24/pack	\$14.95/pk
9043	3" x 4yd, 12/pack	\$10.95/pk
9044	4" x 4yd, 12/pack	\$14.95/pk
9046	6" x 4 yds, 6/pk	\$10.50/pk

BUY NOW

Jorvet Transparent Dressing

These transparent semi-permeable dressings are extensively used in human medical cases. Any person who has had an IV line most likely has worn one. In addition these dressings are useful in covering simple wounds in areas that might be exposed to high levels of contamination, but don't need layers of bandaging material.

- Transparency: the film is ultra thin so observation of wound site is possible.
- Permeable: skin is able to "breathe" as the film is permeable to gas and vapor.
- Bacteria and waterproof: keeps contaminants and water out that may be contacted in day to day living.
- Low sensitivity/viscosity: no irritation to wound and is not painful when removed.
- Ultra thin and high elasticity: compliant binding on skin along body curves. Also a comfortable fit.
- Numerous configurations for various applications
- Sterile and inexpensive to use



JOR1090C	10cm X 12cm, 50/bx	\$39.00/ea
----------	--------------------	------------



BUY NOW

Combine Dressing

Combine pads consist of three key layers: outer nonwoven layer to wick, fluff filler to absorb and disperse fluid and wet proof moisture barrier to retard fluid strike-through. These pads act as a reservoir, reduces pooling and protects against contamination.



AB05X9	5" X 9", 50/Bag, Non-Sterile	\$6.99/pk
AB08X7.5	8" x 7.5", 50/Bag	\$6.99/bg
AB08X7.5CS	8" x 7.5", 576/case	\$34.95/cs
AB08X10	8" x 10", 50/Bag, Non-Sterile	\$9.99/pk
AB08X10CS	8" x 10", Non-Sterile, 432/cs	\$44.99/cs

TOP SELLER

BUY NOW

Abdominal (Combine) Pad

Super absorbent abdominal pads feature a soft non-woven outer layer that quickly wicks fluid to a cellulose center. This thick layer of cellulose quickly absorbs and disperses fluids laterally to prevent pooling. Hydrophobic back impedes strike through and all edges are sealed to prevent linting.

NEW

AB05X9STRL	5" x 9", 400/cs, Sterile	\$37.57/cs
------------	--------------------------	------------

BUY NOW

Silver Sulfadiazine Cream

RXSSD-25	1%, 25 gram tube	\$7.57/ea
RXSSD-50	1%, 50 gram jar	\$12.85/ea
RXSSD-400	1%, 400 gram jar	\$50.79/ea



BUY NOW

Intracell Powder

RXROUND-POW	45gm	\$20.00/bt
-------------	------	------------

Stratasorb Composite Island Dressing

Stratasorb Composite Island Dressing has four distinct layers designed to cover all stages of wound care.

latexfree

Layer 1, a non-adherent contact layer, protects the wound site and will not stick to granulating tissue.

Layer 2, a soft pad, absorbs drainage.

Layer 3, a non-woven backing with an adhesive border, securely holds the contact pad in place.

Layer 4, a semi-occlusive, polyurethane film, helps deter external contaminants and maintain an optimal wound environment. Rectangular shape is designed for post-op applications.



MSC3068Z	6" x 7.5", 10/bx	\$14.95/bx
----------	------------------	------------

BUY NOW

13822 WEST BOULTON BLVD. METAWA, IL 60045

Phone 800-544-7521

1-800

WWW.SHOPMEDVET.COM

Fax 800-204-2177

Wound Care Products



Ace Bandages, Adhesive Bandages & Wound Pads

Unna's Boot **BUY NOW**

Suited for a wide variety of applications, it offers firm even pressure for sustained periods of time. Coated with zinc-oxide, to promote healing for a wide variety of dermatitis and dermal ulcers. One roll per package!

UNNA3	3", 10 Yards in length	\$5.95/ea
UNNA4	4", 10 Yards in length	\$6.95/ea



Jorvet Esmark Bandage/Tourniquet

Latex roll that is excellent for bloodless surgical field (i.e., equine lower limb).

Jorvet

as low as
\$720/ea

JOR486A	4" x 12', Sterile	\$7.20/ea
JOR486AN	4" x 12', Non-Sterile	\$4.65/ea
JOR486B	3" x 9', Sterile	\$5.40/ea
JOR486BN	3" x 9', Non-Sterile	\$4.20/ea



BUY NOW

Jorvet X-span Tubular Dressing

This tube-shaped gauze material is designed to hold a primary dressing in place. It is excellent for use on body parts that are difficult to secure with tape (i.e., the head). The material has a remarkable amount of stretch for optimum fit. Mid-line colored stripe for orientation.

Jorvet

JOR292	16mm (5/8")	\$19.80/ea
JOR292A	25mm (1")	\$19.80/ea
JOR292B	32mm (1 1/4")	\$24.00/ea
JOR292C	50mm (2 3/8")	\$31.50/ea
JOR292E	75mm (3")	\$41.00/ea

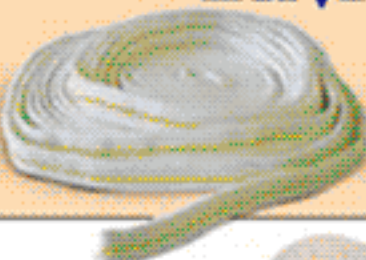

BUY NOW

X-Heavy Moleskin

MS12X5	12" x 5 yds	\$28.95/rl
MS2X5	2" X 5 yds	\$5.95/rl

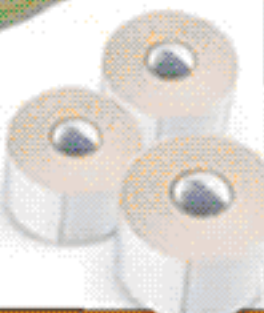

BUY NOW

Adhesive Bandages **BUY NOW**

Easy opening plastic adhesive bandages go on fast and won't stick to wound, various manufacturers.

BA1	1" X 3" 100/bx	\$2.99/bx
BA3/4	3/4" X 3" 100/bx	\$2.49/bx

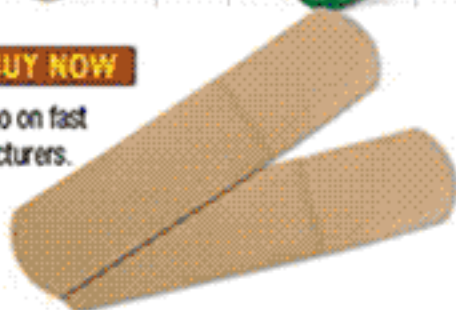

Jorvet Ace Bandage w/self close Velcro

These are the familiar beige stretch bandages. They are very useful for long standing injuries that require a large number of bandage changes. Choice of two closure styles. Individually wrapped. Both ends have velcro for easy starting and closure.

BUY NOW

JOR859	2"W. 186" L stretched	\$22.00/dz
JOR859A	3"W. 210" L stretched	\$27.50/dz
JOR859B	4"W. 210" L stretched	\$33.20/dz
JOR859C	6"W. 210" L stretched	\$54.00/dz



Jorvet Ace Elastic Compression Bandage

These are the familiar beige stretch bandages. They are very useful for long standing injuries that require a large number of bandage changes. Choice of two closure styles. Individually wrapped.

BUY NOW

JOR858	2"W. 186" L stretched, 12/bx	\$15.00/dz
JOR858A	3"W. 186" L stretched, 12/bx	\$17.00/dz
JOR858B	4"W. 186" L stretched, 12/bx	\$21.30/dz
JOR858C	6"W. 168" L stretched, 12/bx	\$27.30/dz



Jorvet Absorbent Wound Pads **BUY NOW**

These pads lift and remove wound exudate in the same way that a disposable diaper works. The outer layers are a thin layer that allows moisture to pass into the thick middle absorbent layer. This keeps the wound surface dry. 5" x 9" green midline strip. It can be trimmed for sizing. Sterile package in chevron pouch. 25 pieces/box. Less expensive and more absorbent than telfa pads.

BUY NOW

JOR1079	5" x 9", 25pk	\$4.50/pk
---------	---------------	-----------

\$450/pk



Jorvet Equine Leg Wrap

Made of soft quality bulk cotton which is covered on both sides with a permeable thin layer of nonwoven material. The wrap acts much like a diaper in that the wound exudate is lifted and absorbed into the thick middle cotton layer. A dark mark mid-line runs full length to give proper orientation during application. A wide variety of materials and sizes are now available.



BUY NOW

JOR849	Large Bulk Roll, 12" x 10 yds.	\$21.60/ea
JOR849A	Large Bulk Roll, 14" x 10 yds.	\$24.50/ea
JOR849B	Large Bulk Roll, 16" x 10 yds.	\$28.00/ea
JOR849AN	Individual, Non-sterile, 12" x 36"	\$4.50/ea
JOR849BN	Individual, Non-sterile, 12" x 42"	\$4.65/ea
JOR849CN	Individual, Non-sterile, 14" x 42"	\$4.80/ea
JOR849DN	Individual, Non-sterile, 16" x 54"	\$6.75/ea
JOR849AS	Individual, Non-sterile, 12" x 36"	\$5.25/ea
JOR849BS	Individual, Non-sterile, 12" x 42"	\$5.40/ea
JOR849CS	Individual, Non-sterile, 14" x 42"	\$5.55/ea
JOR849DS	Individual, Non-sterile, 16" x 54"	\$7.05/ea



13822 WEST BOULTON BLVD. METTAWA, IL 60045

WWW.SHOPMEDVET.COM

Phone 800-544-7521

181

Fax 800-204-2177

Angelica Angelstat® Scrubs

Designed for comfort, our popular 50% polyester / 50% cotton AngelStat® fabric is soft yet durable. Reversible pants feature drawstring waist and back pocket inside and out. Pants also feature four-panel construction (double needle inseam and out seam) for better fit. Drawstrings are color coded for easy size identification. Generously cut sizes XS-3XL. Add \$2.00 for XX-Large & \$3.00 for XXX-Large sizes. Angelstat® is a registered trademark of Medcrest. These Scrubs always gets the job done.



BUY NOW

White W	Ciel Blue CB	Misty Green MG	Sapphire SAP	Emerald Green EG	Navy N
Gray G	Peacock PEC	Jade Green JG	Purple PUR	Hunter Green HG	Raspberry RAS

Call for available colors and sizes.
No returns on embroidered items. All sales are final
Add \$2.00 for XX-Large & \$3.00 for XXX-Large sizes.

Product# Example:
(when ordering)

AngelStat®

Shirts or Pants

Brand: **AS** | Color: **CB** | Size: **XL**

Shirts
\$9⁴⁴

Pants
\$10⁴⁹

Angelstat® Sizing Chart (Unisex Reversible Shirt)

Unisex Size	XS	S	M	L	XL	XXL	XXXL
Size	30 - 32	34 - 36	38 - 40	42 - 44	46 - 48	50 - 52	54 - 56
Chest	30 - 32	34 - 36	38 - 40	42 - 44	46 - 48	50 - 52	54 - 56
Waist	24 - 26	28 - 30	32 - 34	36 - 38	40 - 42	44 - 46	48 - 50
Hip	30 - 32	34 - 36	38 - 40	42 - 44	46 - 48	50 - 52	54 - 56
Neck	12 - 13.5	14 - 14.5	15 - 15.5	16 - 16.5	17 - 17.5	18 - 18.5	19 - 19.5

Med-Vet Encore Scrubs

Med-Vet Encore Scrubs

Our top-selling Encore scrub pants are designed using the most generous cut in the industry. Encore Cloth is a comfortable 45% Polyester / 55% Cotton blend guaranteeing comfort and durability. These pants feature a drawstring waist and a pocket on the back right side. Add \$2.00 for XX-Large & \$3.00 for XXX-Large sizes.

BUY NOW

Shirts
\$7⁴⁹

Pants
\$8⁴⁹



Call for available colors and sizes.
No returns on embroidered items.
All sales are final
Add \$2.00 for XX-Large & \$3.00 for XXX-Large sizes.

Product#
Example:
(when ordering)

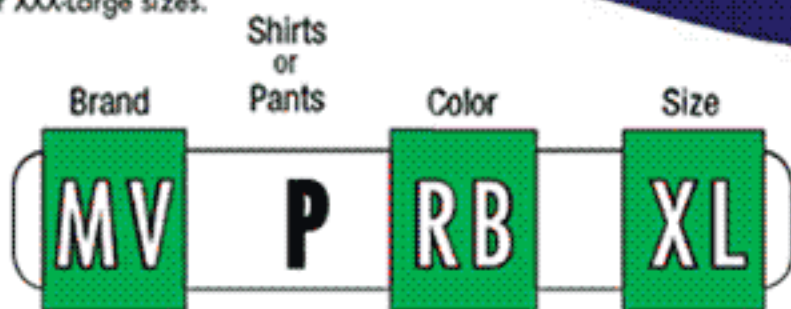

BUY NOW

Med-Vet

Premier Sizing Chart (Unisex Reversible Shirt)						
Chest	S	M	L	XL	XXL	XXXL
	35-38	39-42	43-46	47-50	51-54	55-58

Premier Sizing Chart (Unisex Reversible Pants)						
Waist	S	M	L	XL	XXL	XXXL
	30-32	34-36	38-40	42-44	46-48	50-52

Scrubs & Apparel

Surgical & Isolation Gowns

Proxima

NEW

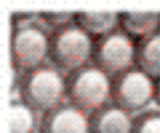

MADE WITH SUPREL[®]
MEDICAL FABRIC



Aurora Surgical Gown

Aurora Surgical Gown

BUY NOW

Aurora Gown, Non-Reinforced: Aurora gowns are made with Suprel medical fabric from DuPont. This innovative fabric is manufactured using a patented process (utilizing 18 patents) to create a fabric that's both highly protective and extremely comfortable. The fabric features an advanced composite technology that utilizes polyester (for strength) combined with polyethylene (for softness). Aurora gowns offer a high level of protection without compromising comfort. Featuring new fabric technology, Aurora raises the bar for single-use O.R. gowns. Aurora gowns have a smooth texture that glides easily without catching or grabbing, giving you incredible freedom of movement. Plus, the gown helps to quickly transfer heat away from your body, keeping you cool and comfortable. For a high level of protection, Aurora gowns are a great choice. The gown's high hydrostatic head offers superior barrier performance. They are cut wider through the chest and sleeves for a roomier fit and feature a velcro-style neck closure that allows the neckline to easily adjust to a wide variety of people. In addition, the velcro-style closure helps prevent gapping in the front of the gown to further protect against fluids. Aurora gowns are very low linting, minimizing the risk of introducing particles into the O.R. Aurora gowns meet the Standard for flammability of Clothing Textiles CPSC 16 CFR Part 1610.

DYNJP2701	Large, Sterile with Towel 30/case	\$143.92/cs
DYNJP2702	X-Large, Sterile with Towel 30/case	\$149.88/cs
DYNJP2703	XX-Large, Sterile with Towel 18/case	\$103.60/cs

Proxima

NEW



Eclipse Surgical Gown



Eclipse Surgical Gown

BUY NOW

Eclipse Gown, Non-Reinforced: The first feature you will notice about the Eclipse gown is the way it feels. The soft, cloth-like texture says "comfort" as soon as you put it on. Those who spend much of their day in a surgical gown will appreciate the comfort of Eclipse. Eclipse Gowns are cut wider through the chest and sleeves for a roomier fit. The Eclipse gowns feature a velcro-style neck closure that allows the neckline to easily adjust to a wide variety of people. In addition, the velcro-style closure helps prevent gapping in the front of the gown to further help protect against fluids. Eclipse Gowns are made with breathable Softesse medical fabric from DuPont. For more than 25 years, DuPont Softesse medical fabric has been considered an industry standard for medical gowns and drapes. The fabric features advanced material technology that provides a splash resistant barrier that's breathable. It keeps you cool and comfortable while you work, helping you feel confident and in control.

DYNJP2005	Small, Sterile with towel 30/case	\$138.11/cs
DYNJP2001	Large, Sterile with towel 30/case	\$138.11/cs
DYNJP2003	XX-Large, Sterile with towel 18/case	\$136.29/cs
DYNJP2004	XXX-Large, Sterile with towel 18/case	\$136.29/cs

Fluid Resistant Isolation Gowns

Made from Lightweight Fluid-Resistant 4-Ply SMS material. Gowns feature strong seams to withstand fluids. Gowns are generously sized for full coverage and flexibility and are constructed with waist and neck ties to ensure secure fit.

27236	50/cs Regular	\$29.00/cs
27236XL	50/cs X-Large	\$39.00/cs

BUY NOW

Isolation Gown

Fluid resistant. Yellow with full back. Knit fabric wrist cuffs. Universal size, full length with ties. Disposable. Universal Size.

JOR736	Yellow, 50/case	\$63.50/cs
--------	-----------------	------------

NEW

JOR736

BUY NOW

Polyethylene Coated Gown

Polyethylene coated polypropylene gowns provide a high level of fluid protection. Waist and neck ties ensure that gowns remain securely in place to protect clothes.

27114	50/Cs Regular	\$49.95/cs
27114XL	50/Cs X-Large	\$49.95/cs

BUY NOW

Isolation Gown w/Poly Coat

Poly-coated with thin film of protective plastic for fluid repellency. Blue with elastic wrist cuffs. Universal size, full length with ties. Disposable. Universal Size

JOR737	Blue, 50/case	\$75.00/cs
--------	---------------	------------

NEW

13822 WEST BOULTON BLVD. METAWA, IL 60045

Phone 800-544-7521

184

WWW.SHOPMEDVET.COM

Fax 800-204-2177

Scrubs & Apparel

Gowns



Cloth Reusable Surgeon Gown (A)

100% cotton surgeon gown with tunnel belt, unisex. Finest quality surgeon gowns have sturdy double-stitched seams. Full 50" to 56" from shoulder to hem. Raglan sleeves with stockinette cuffs. **BUY NOW**

AHSGM-C	Medium, 100% Cotton	\$19.99/ea
AHSGM-C	Medium, 100% Cotton	\$19.99/ea
AHSGL-C	Large, 100% Cotton	\$19.99/ea
AHSGXL-C	X-Large, 100% Cotton	\$19.99/ea



Sterile Surgeon Gown (B)

BUY NOW

Made from SMS fabric, these sterile surgical gowns come individually packaged. Full back with wrap-around style and knit sleeves. Light blue. Comes with sterile towel.

OSGL	Large	\$3.29/ea	35+\$2.99/ea
OSGXL	XX-Large	\$3.29/ea	35+\$2.99/ea
OSGXL	X-Large	\$3.29/ea	35+\$2.99/ea
OSGM	Medium	\$3.29/ea	35+\$2.99/ea



Cloth Reusable Surgical Gown With Panel (C)

Critical-Coverage Gown. Surgical gown with chest and arm panel for extra protection. **BUY NOW**

AHSGL-P	Large	\$27.99/ea
AHSGXL-P	X-Large	\$27.99/ea

Premium Sterile Surgeon Gown (D)

Sterile surgeon gown comes individually wrapped with towel. These gowns are made of a non-woven material that helps provide a barrier to blood, body fluids and pathogens. They offer a high level of protection without compromising comfort. They are cut wider through the chest and sleeves for a roomier fit and feature a velcro-style neck closure that allows the neckline to easily adjust to a wide variety of people. In addition, the velcro-style closure helps prevent gapping in the front of the gown to further protect against fluids. The gowns are very low linting, minimizing the risk of introducing particles into the O.R. **BUY NOW**

AHSSGL	Large	\$3.49/ea	30+\$3.29/ea
AHSSGXL	X-Large	\$3.49/ea	30+\$3.29/ea
AHSSGXL	XX-Large	\$3.69/ea	30+\$3.59/ea



Disposable Non-Sterile Surgeon Gown (E)

These gowns are made of a non-woven material that helps provide a barrier to blood, body fluids and pathogens. They offer a high level of protection without compromising comfort. They are cut wider through the chest and sleeves for a roomier fit and feature a velcro-style neck closure that allows the neckline to easily adjust to a wide variety of people. In addition, the velcro-style closure helps prevent gapping in the front of the gown to further protect against fluids. The gowns are very low linting, minimizing the risk of introducing particles into the O.R. **BUY NOW**

MVGNSL	Large	\$1.99/ea
MVGNSXL	X-Large	\$1.99/ea
MVGNSXL	XX-Large	\$2.29/ea

Starting At
\$1.99/ea



13822 WEST BOULTON BLVD. METTAWA, IL 60045

WWW.SHOPMEDVET.COM

Phone 800-544-7521

185

Fax 800-204-2177

Gowns

Basic Pack 1

BUY NOW

Medline surgical packs feature SMS drapes competitive with the new industry standard and a choice of either Eclipse®, Aurora or Sirius® gowns. Additionally, our surgical packs include procedural accessories essential to the surgeon. Created specifically for procedure necessity and clinician's preference, our extensive pack line offers a variety of options for every customer. Basic Pack 1 includes table cover, mayo stand cover, utility drapes, half drape, 3/4 drape, hand towels and suture bag.

DYNJP8320 10/case \$139.95/cs



Eclipse Fabric Re-Inforced Gown (with Towel)

BUY NOW

In our continuing efforts to provide you with superb comfort and protection, we have upgraded our Eclipse® gowns with a new higher-quality, SMS fabric. Still equipped with the same great fit and features of all our gowns, the new fabric enhances the Eclipse® line with new attributes: increased breathability, lighter weight, higher hydrostatic head and better wicking/moisture evaporation. Today's most advanced SMS technologies allow us to bring you an incredibly soft gown and increased barrier. Eclipse®, XXL-49" and fabric reinforced.

DYNJP2103 XXL, w/Towel, 18/case

\$72⁸⁴/cs



JorVet Face Shield

BUY NOW

Covers the entire face

- Consists of reusable, lightweight frames, which thin, clear lenses snap onto.
- One size fits all with an adjustable strap.
- Easily worn over glasses and masks.

JOR519 10 frames/10 shields \$61.50/ea
JOR519S Face shields only kit, 10pk. \$29.00/pk



JorVet Eye Shields

BUY NOW

Consists of reusable, lightweight frames, which thin, clear lenses snap onto.

- Removable protective film protects lenses before use.
- One size fits all.
- Frames come in an assortment of colors

JOR518 10 frames/25 shields \$37.50/ea
JOR518S Eye shields only refill kit, 25pk \$21.00/pk



Goggles Fog Free (with Vents)

Fluid Protective Goggles. Soft, vinyl-frame goggles fit easily over prescription eyewear. Four air vents provide additional comfort. Available with specially-treated, anti-fog lenses for clear, unobstructed viewing. Goggles meet ANSI standards and help your facility meet OSHA requirements for hazardous liquids. Fog Free

NON24775 Fog free \$4.99/ea



Safety Goggles

BUY NOW

Molded of soft clean flexible vinyl that conforms to the face and nose. Four vents eliminate fogging. Clean acetate lenses. Can be worn over regular glasses.

JOR827 1/2"W adjustable head band. \$32.40/ea



Surgical Masks

BUY NOW

An excellent quality surgical mask can reduce exposure to blood and other bodily fluids with a 99% filtration fluid resistance. In today's medicine, a surgical mask is a necessary respiratory and contact precaution.

MASK-C	Cone, 50/bx	\$6.00/bx	5+ \$5.00/bx
MASK-E	Earloop, 50/bx	\$5.00/bx	5+ \$4.00/bx
MASK-T	Tie on, 50/bx	\$5.00/pk	5+ \$4.00/bx
MASK-T-FF	Tie-on Fog Free 50/bx	\$11.50/bx	



As Low As
\$5.00/bx



Bouffant Cap

BUY NOW

- Soft
- Breathable
- Elastic band opening
- Meets NFPA standards. No color choice

BOUFFANT 100/bx \$8.00/bx



Surgeon Cap

BUY NOW

- Durable
- Soft and comfortable
- Tie-on
- One size fits all
- Blue 100/bx

SURGCAP 100/bx \$9.99/bx



Shoecover

BUY NOW

A soft, durable and lightweight shoecover. Has a fuller cut and a more generous heel and instep. Designed to fit both large and small shoe sizes comfortably and snugly. 100 per box.

SHOECOVER	100/bx	\$8.00/bx	
SHOECOVER-NS	NON-SKID, 100/bx	\$8.95/bx	2+ \$8.00/bx
SHOECOVER-XL	200/bx X-Large	\$23.90/bx	



Jorvet Shoecover

SHOECOVER

Disposable Shoe Cover. Non-conductive and non-skid. Blue. Universal size. Bulk packaged in dispensing box.

JOR730 100/bx, 3bx/case \$41.00/cs

BUY NOW

Surgical Procedure Mask w/ Ear Loops

BUY NOW

Procedure Mask with earloops. 2-ply.

JOR733 50/bx, 12 bx/case. \$62.50/cs

Surgery Mask, 3 ply w/ Ties

Surgery Mask with ties. Blue. 3-ply. 18cm x 20cm. Bulk packaged in dispensing box.

BUY NOW

JOR731 50/bx, 6 bx/case. \$38.50/cs



Disposable Apron

GLX390

All purpose garment. Oil and chemical resistant. Great for jobs around the kennel/clinic. Dispensing box

GLX390 32" x 50", 100/cs \$19.95/cs

BUY NOW



Jorvet Disposable Aprons

JOR345M

JOR345M 28" x 46" long., 100/pk, 100/pk \$59.00/pk

BUY NOW



Rubberized OB Supplies & Coveralls

Jorvet Rubberized OB Suit

Rubberized OB Suit. With pants and jacket. **BUY NOW**

JOR30SR-S	Small, (2 pc)	\$188.00/ea
JOR30SR-L	Large (2pc)	\$189.00/ea
JOR30SR-M	Medium (2pc)	\$183.00/ea
JOR30SR-XL	X-Large (2 pc)	\$183.00/ea

Rubberized OB Cover-All Suit

Rubberized OB CoverAll Suit. One piece. **BUY NOW**

JOR30CSR-S	Small	\$164.00/ea
JOR30CSR-M	Medium	\$168.00/ea
JOR30CSR-L	Large	\$168.00/ea
JOR30CSR-XL	X-Large	\$182.00/ea

Rubberized OB Overalls

Easy to snap-on Suspenders. **JorVet**

JOR30OS	Small	\$110.00/ea
JOR30OM	Medium	\$110.00/ea
JOR30OL	Large	\$110.00/ea
JOR30OXL	X-Large	\$120.00/ea

Total OB Sleeve

The "Total" OB Sleeve. This new product gives additional coverage to the whole shoulder and under arm area. No need for clamps to hold in place or a separate shoulder protector. Helps reduce laundry expense and reduces accidental manure stains and smell. This glove is sensitive but strong, 1-mil thick with strong smooth seams. Package is 50 sleeves in a pull out dispensing box.

JOR300D	Regular (Box of 50)	\$21.00/bx
JOR300DS	Small (box of 50)	\$21.00/bx

JorVet



Tyvek Coveralls

BUY NOW

These lint-free Tyvek coveralls offer enough protection for use in the O.R. "clean" area. These coveralls are sturdy and feature a full-length zipper for ease of use.

COVERALL-TY-L	Large, 25/cs	\$162.30/cs
COVERALL-TY-XL	X-Large, 25/CS	\$167.03/cs
COVERALL-TY-XXL	XX-Large, 25/CS	\$172.20/cs

Boot Cover (Non-Skid Impervious)

Non-Skid impervious boot covers with Polyethylene coating reduces chance of fluid penetration. These latex-free boot covers are ultrasonically sealed on all sides. The seamless cover has no holes, omitting the risk of fluid penetration. The convenient Velcro® strap is heat-sealed to the boot and allows the wearer to adjust the fit. They feature non skid tread for increased stability.

BOOTCOVER	150/cs	\$143.45/cs
BOOTCOVERXL	150/cs	\$149.96/cs



BUY NOW

Rubberized OB Smock

This smock features the special easy-to-clean arm shields. Very durable. **BUY NOW**

JOR30R-L	Large	\$125.00/ea
JOR30R-S	Small	\$110.00/ea
JOR30R-XL	X-Large	\$113.00/ea
JOR30R-M	Medium	\$113.00/ea

Rubberized OB Pants

Rubberized OB Pants only. **BUY NOW**

JOR30PR-S	Small	\$73.00/ea
JOR30PR-M	Medium	\$73.00/ea
JOR30PR-L	Large	\$73.00/ea

JOR30JR & JOR30PR

BUY NOW



JOR29c JOR29



JOR29a

BUY NOW

Rubberized OB Jacket

Rubberized OB Jacket only. **BUY NOW**

JOR30JR-M	Medium	\$110.00/ea
JOR30JR-S	Small	\$110.00/ea
JOR30JDXL	X-Large	\$126.00/ea
JOR30JR-L	Large	\$116.00/ea

Rubberized OB Apron (H)

Rubberized OB Apron. Suitable for wearing in conjunction with JOR29 or JOR29c. **BUY NOW**

JOR29A Rubberized, 120cm or 48" L \$37.50/ea

OB Shoulder Protector

This is the original Danish import, where the arm passes through an opening in the special easy-to-clean rubber shield. There's no bunching of the material in the arm area. If worn in conjunction with a rubber apron, it serves as an OB smock. Protector ties under opposite arm. **JorVet**

JOR29 Heat-sealed seams \$45.00/ea

OB Shoulder Cuff

BUY NOW

Basically the same as JOR29 above, but less area is covered. Very handy in conjunction with disposable or rubber sleeves.

JOR29C Heat-sealed seams \$33.00/ea

JorVet



Disposable Plastic Boots

Fits over cowboy boots and large work shoes. Handy tie feature keeps boots on tight. Blue.

JOR100B	4ml, 50/pk, 18"H x 14 3/4"L	\$18.90/pk
JOR100BL	Heavy 4 mil thickness, 21"H x 16"L, 50/bag	\$19.20/pk

BUY NOW

Breathable Coveralls

These latex-free coveralls are made of totally fluid-proof, yet breathable material. These deluxe cut coveralls are extra roomy and fit easily over street clothes for quick access to the O.R. or clean areas. Each coverall features a full length zipper in front, elastic gathers in back for a superior fit and extra room in the sleeves for easy mobility. The breathable coveralls are great for extended wear periods and are a more comfortable and cost effective option to Tyvek coveralls.

BUY NOW

COVERALL-BR-L	White, Large, 25/cs	\$109.05/cs
COVERALL-BR-XXL	White, XX-Large, 25/cs	\$114.53/cs
COVERALL-BR-XL	White, X-Large, 25/cs	\$109.05/cs



LAB COATS

CHECK OUT OUR **NEW** LINE OF QUALITY LAB COATS

Full Length Lab Coat

Easy care 80% polyester/20% cotton poplin fabric that's designed to resist wrinkles. Button-front styling with two lower pockets, one chest pocket with pencil slot, and side vent openings for easy access to pants pockets. 43" length.

BUY NOW

MDT14WHT34E	size 34	\$15.99/ea
MDT14WHT36E	size 36	\$15.99/ea
MDT14WHT38E	size 38	\$15.99/ea
MDT14WHT40E	size 40	\$15.99/ea
MDT14WHT42E	size 42	\$15.99/ea
MDT14WHT44E	size 44	\$15.99/ea
MDT14WHT46E	size 46	\$15.99/ea
MDT14WHT48E	size 48	\$15.99/ea
MDT14WHT50E	size 50	\$17.10/ea
MDT14WHT52E	size 52	\$17.10/ea
MDT14WHT54E	size 54	\$18.72/ea
MDT14WHT56E	size 56	\$21.04/ea



NEW

BUY NOW

Full Length Tall Lab Coat

MDT14WHT42TE	size 42 tall	\$18.95/ea
MDT14WHT44TE	size 44 tall	\$18.95/ea
MDT14WHT46TE	size 46 tall	\$18.95/ea
MDT14WHT48TE	size 48 tall	\$17.95/ea
MDT14WHT50TE	size 50 tall	\$20.75/ea
MDT14WHT52TE	size 52 tall	\$19.75/ea

Knee Length Lab Coat

Button-front style features a lapel collar, left breast pocket, two lower pockets, plain back and side slash openings for easy access to pants pockets. 41" length. 65% polyester 35% cotton.

WHITE BUY NOW

830440HWXS	X-Small	\$16.99/ea
830440HWS	Small	\$16.99/ea
830440HWM	Medium	\$16.99/ea
830440HWL	Large	\$16.99/ea
830440HWXL	X-Large	\$16.99/ea
830440HWXXL	XX-Large	\$17.59/ea
830440HWXXXL	XXX-Large	\$19.16/ea

NAVY BUY NOW

83044RNS	Small	\$19.95/ea
83044RNM	Medium	\$19.95/ea
83044RNL	Large	\$19.95/ea
83044RNDL	X-Large	\$19.95/ea
83044RNDXL	XX-Large	\$21.99/ea
83044RNDXXXL	XXX-Large	\$21.99/ea

TOP SELLER



Men's Lab Coat

BUY NOW

Our premium lab coat is pre-shrunk, 100% heavyweight cotton twill for extra durability and is nicely detailed with knot button closures in front and on the back belt. With a pencil divided left breast pocket, two lower pockets and side slash openings for easy access to pants pockets. Back vent. 44" length.

317TNS40	White, Size 40	\$28.26/ea
317TNS42	White, Size 42	\$28.26/ea
317TNS44	White, Size 44	\$28.26/ea



NEW

Ladies Full Length Lab Coat

Easy care 80% polyester/20% cotton poplin. White button front lab coat with two lower pockets, one chest pocket. Tailored fit with princess style seams on back. 2-button adjustable back belt. 40" length.

BUY NOW

MDT13WHT1E	Small	\$15.99/ea
MDT13WHT2E	Medium	\$15.99/ea
MDT13WHT3E	Large	\$15.99/ea
MDT13WHT4E	Extra Large	\$16.11/ea
MDT13WHT5E	XX-Large	\$17.64/ea
MDT13WHT6E	XXX-Large	\$17.64/ea

Disposable Lab Coat

Knee length BUY NOW

JOR946SB	Ciel Blue, Small, 10/pk	\$36.00/ea
JOR946MB	Ciel Blue, Medium, 10/pk	\$36.00/ea
JOR946LB	Ciel Blue, Large, 10/pk	\$35.00/pk
JOR946XB	Ciel Blue, X-Large, 10/pk	\$36.00/pk
JOR946SG	Teal Green, Small, 10/pk	\$36.00/pk
JOR946MG	Teal Green, Medium, 10/pk	\$38.00/pk
JOR946LG	Teal Green, Large, 10/pk	\$37.00/pk
JOR946XG	Teal Green, X-Large, 10/pk	\$36.00/pk

Hip length BUY NOW

JOR945SG	Teal Green, Small, 10/pk	\$37.00/ea
JOR945MG	Teal Green, Medium, 10/pk	\$37.00/ea
JOR945LG	Teal Green, Large, 10/pk	\$37.00/ea
JOR945XG	Teal Green, X-Large, 10/pk	\$37.00/ea
JOR945SB	Ciel Blue, Small, 10/pk	\$37.00/ea
JOR945MB	Ciel Blue, Medium, 10/pk	\$37.00/ea
JOR945LB	Ciel Blue, Large, 10/pk	\$37.00/ea
JOR945XB	Ciel Blue, X-Large, 10/pk	\$37.00/ea



NEW

13822 WEST BOULTON BLVD. METTAWA, IL 60045

WWW.SHOPMEDVET.COM

Phone 800-544-7521

189

Fax 800-204-2177

COATS MED-VET'S

SCRUBS DEPOT

CLOSEOUT LIMITED SUPPLY

As Low As 99¢ CLOSEOUT Scrubs While Supplies Last!

BUY NOW

BUY NOW

WOMEN'S LAB JACKET LONG SLEEVE

47433-W10	LAB JACKET, WHITE, LONG SLEEVE, WOMEN'S, SIZE 10	\$5.99
47433-W12	LAB JACKET, WHITE, LONG SLEEVE, WOMEN'S, SIZE 12	\$5.99
47433-W14	LAB JACKET, WHITE, LONG SLEEVE, WOMEN'S, SIZE 14	\$3.99
47433-W16	LAB JACKET, WHITE, LONG SLEEVE, WOMEN'S, SIZE 16	\$5.99

LAB COAT PROTECTIVE STANDUP COLLAR UNISEX

46943-WT5	LAB COAT, PROTECTIVE, STANDUP COLLAR, UNISEX	\$5.99
-----------	--	--------

LADIES LAB COAT STAFF LENGTH

MDT11BCA24E	LAB COAT, LADIES STAFF LENGTH, SZ 24, WHITE, EACH	\$9.99
MDT11BCA28E	LAB COAT, LADIES STAFF LENGTH, SZ 28, WHITE, EACH	\$9.99

LAB COAT WHITE MED LENGTH CLOTH BUTTONS

X1425W-30	LAB COAT, WHITE, MED LENGTH, COTTON, CLOTH BUTTONS, SIZE 30	\$10.99
-----------	---	---------

LAB COAT WRAP, BACK TIE, UNISEX

6130-L	LAB COAT WRAP, WHITE, BACK TIE, UNISEX, LARGE	\$3.99
6130-S	LAB COAT WRAP, WHITE, BACK TIE, UNISEX, SMALL	\$3.99

LAB COAT WHITE SHORT SLEEVE UNISEX

47402-W56	LAB COAT, WHITE, SHORT SLEEVE, UNISEX, SIZE 56	\$3.99
-----------	--	--------

MIXED LAB COATS

6467-011-32	LAB COAT, WHITE, KNEE LENGTH, SNAP FRONT, MENS, SIZE 32	\$7.95
6467-011-38	LAB COAT, WHITE, KNEE LENGTH, SNAP FRONT, MENS, SIZE 38	\$7.95
6466-011-44	LAB COAT, WHITE, KNEE LENGTH, 4 BUTTON, MENS, SIZE 44	\$7.95

LAB COAT WHITE MED LENGTH CLOTH BUTTONS

X1425W-30	LAB COAT, WHITE, MED LENGTH, COTTON, CLOTH BUTTONS, SIZE 30	\$10.99
-----------	---	---------

LAB COAT WHITE SHORT SLEEVE UNISEX

47402-W40	LAB COAT, WHITE, SHORT SLEEVE, UNISEX, SIZE 40	\$3.99
-----------	--	--------

LAB COAT WHITE UNISEX

HX3419-30	LAB COAT, WHITE, UNISEX, SIZE 30	\$7.95
-----------	----------------------------------	--------

LABCOAT DISPOSABLE SNAP FRONT

3511-M	LABCOAT, DISPOSABLE, SNAP FRONT, MEDIUM, WHITE, 30/CS	\$19.95
--------	---	---------

SINGLE SUTURE UP TO 70% Off

For Teaching & Research

SUTUREDIRECT.COM

CLOSEOUT

SYRINGES & NEEDLES

As low as
\$5.00/bx

STOCK UP - WHILE SUPPLIES LAST!

ELASTIC, PLASTIC & PAPER MEDICAL TAPE

As low as
\$5.00/bx

A LIMITED SUPPLY - WHILE SUPPLIES LAST!

CLOSEOUT Labcoats not included in 99¢ Scrubs special

13822 WEST BOULTON BLVD. METTAWA, IL 60045

WWW.SHOPMEDVET.COM

Phone 800-544-7521

190

Fax 800-204-2177

COATS MED-VET'S

SCRUBS DEPOT

CLOSEOUT LIMITED SUPPLY

As Low As 99¢ CLOSEOUT Scrubs While Supplies Last!

BUY NOW

BUY NOW

MEDIUM LENGTH LAB COAT

Stitched down back belt. One inside pocket. Side slits for hand access. Pencil pocket within breast pocket. Back vent. 65% poly 35% cotton twill with Visa® soil release. Available in white.

MLC42 LAB COAT, MED LENGTH, SZ 42, WHITE \$10.99

CLASSIC LONG LAB COAT

Knee length. Loose two-piece back belt. Side slits for hand access. One inside pocket. Pencil pocket within breast pocket. Back vent. 65% poly 35% cotton twill with Visa® soil release. Available in white.

CLC42 LAB COAT, CLASSIC, SZ 42, WHITE, EACH \$10.99

KNEE LENGTH LAB COAT

418-M LAB COAT, WHITE, KNEE LENGTH, UNISEX, SNAPS, MEDIUM \$10.99

418-XXL LAB COAT, WHITE, KNEE LENGTH, UNISEX, SNAPS, XX-LARGE \$13.99

FULL LENGTH LAB COAT

7143XXXL LAB COAT, WHITE, FULL LENGTH, UNISEX, XXX-LARGE \$12.99

7143XXL LAB COAT, WHITE, FULL LENGTH, UNISEX, XX-LARGE \$12.99

KNEE LENGTH LAB COAT

418-M LAB COAT, WHITE, KNEE LENGTH, UNISEX, SNAPS, MEDIUM \$10.99

418-XXL LAB COAT, WHITE, KNEE LENGTH, UNISEX, SNAPS, XX-LARGE \$13.99

418-XXXL LAB COAT, WHITE, KNEE LENGTH, UNISEX, SNAPS, XXX-LARGE \$13.99

SAVE ON WARM-UPS

As low as

99¢/ea

SEE PAGE 197 - WHILE SUPPLIES LAST!



WHILE SUPPLIES LAST

Hurry, These are going fast!

CLOSEOUT Labcoats not included in 99¢ Scrubs special

LAB COAT SURPLUS BLOWOUT

Unisex Staff Length Lab Coat

Women's Lab Coat 80% polyester/20% cotton poplin. White button front lab coat with two lower pockets, one check pocket. Staff length.

ONLY TWO SIZES LEFT!

MDT12WHT42E Size 42, White, Staff Length \$18.18/ea

MDT12WHT44EL Size 44, White, Staff Length \$9.99/ea

WHILE QUANTITIES LAST!!!

Safety Goggles & Surgical Masks

**See Our Surgical Section**

13822 WEST BOULTON BLVD. METTAWA, IL 60045

WWW.SHOPMEDVET.COM

Phone 800-544-7521**Fax 800-204-2177**

SHIRTS MED-VET'S

SCRUBS DEPOT

CLOSEOUT LIMITED SUPPLY

As Low As 99¢ CLOSEOUT Scrubs While Supplies Last!

BUY NOW

SHIRTS

X-SMALL

2982-131	SHIRT, JADE GREEN, REVERSIBLE, KALMOGRAPHED, X-SMALL	\$0.99
SJGXS	SHIRT, JADE GREEN, X-SMALL	\$0.99
SMGXS	SHIRT, MISTY GREEN, X-SMALL	\$0.99
SWXS-KAUM	SHIRT, WHITE, KAUM, X-SMALL	\$0.99
SEGXS	SHIRT, EMERALD GREEN, X-SMALL	\$0.99
SJGXS-CAP	SHIRT, JADE GREEN, CAP SLEEVE, X-SMALL	\$0.99
STXS	SHIRT, TEAL, X-SMALL	\$0.99

SMALL

46875-2L3	SHIRT, TEAL, VNECK, UNISEX, SMALL	\$0.99
SGS	SHIRT, GRAY, SMALL	\$4.99
SJGS	SHIRT, JADE GREEN, SMALL	\$0.99
SMGS-CAP	SHIRT, MISTY GREEN, CAP SLEEVE, SMALL	\$2.99
T-SBLKS	T-SHIRT, BLACK, UNISEX, SMALL	\$2.99
SCBS	SHIRT, CIEL BLUE, SMALL	\$2.99
SWS	SHIRT, WHITE, SMALL	\$4.99
T-SJGS	T-SHIRT, JADE GREEN, UNISEX, SMALL	\$0.99
SJGS-CAP	SHIRT, JADE GREEN, CAP SLEEVE, SMALL	\$0.99
SRBS	SHIRT, ROYAL BLUE, SMALL	\$0.99

MEDIUM

SCBM-CAP	SHIRT, CIEL BLUE, CAP SLEEVE, MEDIUM	\$2.99
SMGM	SHIRT, MISTY GREEN, MEDIUM	\$4.99
46864-1L5	SHIRT, TEAL, UNISEX, MEDIUM	\$3.99

LARGE

SCBL-CAP	SHIRT, CIEL BLUE, CAP SLEEVE, LARGE	\$4.99
----------	-------------------------------------	--------

XX-LARGE

SFBXXL-POLO	SHIRT, ROYAL BLUE, XX-L, POLO	\$7.49
SWXXL-CAP	SHIRT, WHITE, CAP SLEEVE, XX-L	\$4.99

BUY NOW

SHIRTS

XXX-LARGE

SCBXXL	SHIRT, CIEL BLUE, XXX-LARGE	\$4.99
SWXXL	SHIRT, WHITE, XXX-LARGE	\$4.99
SJGXXL-CAP	SHIRT, JADE GREEN, XXX-LARGE	\$0.99

BUY NOW

PANTS

X-SMALL PETITE

12004-1200-XSP	PANTS, OLIVE GREEN, ELASTIC WAIST, WOMEN'S, XS-PETITE	\$0.99
12003-1200-XSP	PANTS, OLIVE GREEN, ELASTIC WAIST, CARGO POCKET, WOMEN'S, XS-PETITE	\$0.99

X-SMALL

2983-131	PANTS, JADE GREEN, REVERSIBLE, KALMOGRAPHED, X-SMALL	\$0.99
46565-1R1	PANTS, ORCHID, W/O POCKETS, WOMEN'S, X-SMALL	\$0.99
46565-1T1	PANTS, TIFFANY TURQUOISE, W/O POCKETS, WOMEN'S, X-SMALL	\$0.99
PMGXS	PANTS, MISTY GREEN, X-SMALL	\$0.99
PTRXS-EW	PANTS, TEA ROSE, ELASTIC WAIST, X-SMALL	\$0.99
46868-1G1	PANTS, ASH GRAY, DRAWSTRING, UNISEX, X-SMALL	\$3.99
N46877-131	PANTS, GREEN, ELASTIC WAIST, WOMEN'S, X-SMALL	\$3.99
46598-131	PANTS, GREEN, TAILORED, WOMEN'S, X-SMALL	\$3.99
46598-1H1	PANTS, SHERWOOD GREEN, TAILORED, WOMEN'S, X-SMALL	\$3.99
46594-141	PANTS, WILD PLUM, CARGO, WOMEN'S, X-SMALL	\$3.99
PJGXS	PANTS, JADE GREEN, X-SMALL	\$4.99
PTXS	PANTS, TEAL, X-SMALL	\$4.99

HURRY THESE ARE SELLING OUT FAST!

When they're gone they're gone!

CLOSEOUT Labcoats not included in 99¢ Scrubs special

13822 WEST BOULTON BLVD. METTAWA, IL 60045

Phone 800-544-7521

192

WWW.SHOPMEDVET.COM

Fax 800-204-2177

PANTS**MED-VET'S**

SCRUBS DEPOT

CLOSEOUT LIMITED SUPPLY

As Low As 99¢ CLOSEOUT Scrubs While Supplies Last!

**SMALL****BUY NOW**

46878-203	PANTS, WHITE, DRAKSTRING, UNISEX, SMALL	\$0.99
HX3403-RG3	PANTS, JADE GREEN, KALMOGRAPHED, UNISEX, SMALL	\$0.99
PMGS	PANTS, MISTY GREEN, SMALL	\$2.99
PPCS	PANTS, PEACOCK, SMALL	\$2.99
46597-163	PANTS, PARFAIT PINK, W/POCKETS, WOMEN'S, SMALL	\$0.99
46598-1H3	PANTS, SHERWOOD GREEN, TAILORED, WOMEN'S, SMALL	\$3.99

MEDIUM**BUY NOW**

46817-125	PANTS, MISTY GREEN, ELASTIC WAIST, WOMEN'S, MEDIUM	\$0.99
PMGM	PANTS, MISTY GREEN, MEDIUM	\$0.99
46597-1S5	PANTS, SOUTH SEA GREEN, W/POCKETS, WOMEN'S, MEDIUM	\$3.99
PMGM-KAUM	PANTS, MISTY GREEN, KALM, MEDIUM	\$2.99
46860-115	PANTS, CEIL BLUE, TAILORED, WOMEN'S, MEDIUM	\$3.99
46594-1S5	PANTS, SOUTH SEA GREEN, CARGO POCKET, WOMEN'S, MEDIUM	\$3.99
PPCM	PANTS, PEACOCK, MEDIUM	\$2.99

LARGE**BUY NOW**

46817-127	PANTS, MISTY GREEN, ELASTIC WAIST, WOMEN'S, LARGE	\$0.99
46817-127	PANTS, MISTY GREEN, ELASTIC WAIST, WOMEN'S, LARGE	\$0.99
46860-1L7	PANTS, TEAL, TAILORED, WOMEN'S, LARGE	\$0.99
PJGL	PANTS, JADE GREEN, LARGE	\$3.99
46860-1N7	PANTS, NAVY, TAILORED, WOMEN'S, LARGE	\$3.99
46860-107	PANTS, WHITE, TAILORED, WOMEN'S, LARGE	\$0.99

X-LARGE PETITE**BUY NOW**

12004-1200-XLP	PANTS, OLIVE GREEN, ELASTIC WAIST, WOMEN'S, XL PETITE	\$0.99
----------------	---	--------

BUY NOW**X-LARGE**

46817-129	PANTS, MISTY GREEN, ELASTIC WAIST, WOMEN'S, X-LARGE	\$0.99
N46877-139	PANTS, GREEN, ELASTIC WAIST, WOMEN'S, X-LARGE	\$3.99
46598-1H9	PANTS, SHERWOOD GREEN, TAILORED, WOMEN'S, X-LARGE	\$3.99
46599-1L9	PANTS, TEAL, ELASTIC WAIST, WOMEN'S, X-LARGE	\$0.99
46860-109	PANTS, WHITE, TAILORED, WOMEN'S, X-LARGE	\$0.99

BUY NOW**XX-LARGE**

46857-232X	PANTS, JADE, ELASTIC WAIST, WOMEN'S, XX-LARGE	\$0.99
46817-122X	PANTS, MISTY GREEN, ELASTIC WAIST, WOMEN'S, XX-LARGE	\$0.99
46837-DR2X	PANTS, DUSTY ROSE, ELASTIC WAIST, WOMEN'S, XX-LARGE	\$3.99
46860-DS2X	PANTS, GREEN, TAILORED, WOMEN'S, XX-LARGE	\$3.99
PJGXXL	PANTS, JADE GREEN, XX-LARGE	\$4.99
HX3403-RG2X	PANTS, JADE GREEN, KALMOGRAPHED, UNISEX, XX-LARGE	\$0.99

BUY NOW**XXX-LARGE**

46857-233X	PANTS, JADE, ELASTIC WAIST, WOMEN'S, XXX-LARGE	\$0.99
46868-1S3X	PANTS, SOUTH SEA GREEN, DRAKSTRING, UNISEX, XXX-LARGE	\$0.99
HX3383-1L3X	PANTS, TEAL, UNISEX, XXX-LARGE	\$0.99
46860-103X	PANTS, WHITE, TAILORED, WOMEN'S, XXX-LARGE	\$0.99
PCBXXXL	PANTS, CEIL BLUE, XXX-LARGE	\$0.99
PJGXXXL	PANTS, JADE GREEN, XXX-LARGE	\$0.99
PMGXXXL	PANTS, MISTY GREEN, XXX-LARGE	\$0.99
46817-123X	PANTS, MISTY GREEN, ELASTIC WAIST, WOMEN'S, XXX-LARGE	\$0.99
46838-113X	PANTS, CEIL BLUE, UNISEX, XXX-LARGE	\$3.99
46598-173X	PANTS, MARINE BLUE, TAILORED, WOMEN'S, XXX-LARGE	\$0.99
46869-1N3X	PANTS, NAVY, ELASTIC WAIST, UNISEX, XXX-LARGE	\$0.99

Shop online 24 hours a day 7 days a week WWW.SHOPMEDVET.COM*CLOSEOUT Labcoats not included in 99¢ Scrubs special***13822 WEST BOULTON BLVD. METTAWA, IL 60045****WWW.SHOPMEDVET.COM****Phone 800-544-7521****193****Fax 800-204-2177**

PANTS

MED-VET'S

SCRUBS DEPOT

CLOSEOUT LIMITED SUPPLY

As Low As 99¢ CLOSEOUT Scrubs While Supplies Last!



BUY NOW

PANTS

XXX-LARGE		
ET0020-SP3X	PANTS, SEA SPRAY, UNISEX, XXX-LARGE	\$0.99
PGXXXL-EW	PANTS, GRAPE, ELASTIC WAIST, XXX-LARGE	\$4.99
PLXXXL-EW	PANTS, LAVENDER, ELASTIC WAIST, XXX-LARGE	\$4.99
PTXXXL	PANTS, TEAL, XXX-LARGE	\$4.99

XXXX-LARGE		
2983-134X	PANTS, JADE GREEN, REVERSIBLE, KALMOGRAPHED, XXXX-LARGE	\$0.99
46594-124X	PANTS, MISTY GREEN, CARGO, WOMEN'S, XXXX-LARGE	\$0.99
46817-124X	PANTS, MISTY GREEN, ELASTIC WAIST, WOMEN'S, XXXX-LARGE	\$0.99
46598-1B4X	PANTS, BORDEAUX, TAILORED, WOMEN'S, XXXX-LARGE	\$3.99

XXXXX-LARGE		
HX3403-RG5X	PANTS, JADE GREEN, KALMOGRAPHED, UNISEX, XXXXX-LARGE	\$0.99
HX3403-RC5X	PANTS, CEIL, KALMOGRAPHED, UNISEX, XXXXX-LARGE	\$0.99
46597-105X	PANTS, VINTAGE ROSE, W/POCKETS, WOMEN'S, XXXXX-LARGE	\$0.99
2983-135X	PANTS, JADE GREEN, REVERSIBLE, KALMOGRAPHED, XXXXX-LARGE	\$0.99

**SIGN UP FOR WEEKLY
PHARMACEUTICAL SPECIALS &
BUY ONE GET ONE FREE DEALS @
WWW.SHOPMEDVET.COM**

BUY NOW

TUNICS

X-SMALL		
33082L1	TUNIC, TEAL, CROSSOVER, REVERSIBLE, X-SMALL	\$0.99
46576-111	TUNIC, CEIL BLUE, EASY-OUT, WOMEN'S, X-SMALL	\$0.99
46576-1B1	TUNIC, BORDEAUX, EASY-OUT, WOMEN'S, X-SMALL	\$0.99
46576-1N1	TUNIC, NAVY, EASY-OUT, WOMEN'S, X-SMALL	\$0.99
46581-171	TUNIC, MARINE BLUE, SILHOUETTE, WOMEN'S, X-SMALL	\$0.99
46581-421	TUNIC, CELEBRATION WHITE, SILHOUETTE, WOMEN'S, X-SMALL	\$0.99
46583-1L1	TUNIC, TEAL, SQUARE NECK, WOMEN'S, X-SMALL	\$0.99
46583-431	TUNIC, CELEBRATION PINK, SQUARE NECK, WOMEN'S, X-SMALL	\$0.99
46586-701	TUNIC, INCA, PRINCESS TUNIC, WOMEN'S, X-SMALL	\$0.99
46815-131	TUNIC, JADE GREEN, UNISEX, X-SMALL	\$0.99
HX3462-2L1	TUNIC, TEAL, SQUARE NECK, WOMEN'S, X-SMALL	\$0.99
46576-1L1	TUNIC, TEAL, EASY-OUT, WOMEN'S, X-SMALL	\$0.99
46876N-111	TUNIC, CEIL BLUE, SET-IN SLEEVE, UNISEX, X-SMALL	\$0.99
46584-781	TUNIC, VINTAGE FLORAL, SLOVER, WOMEN'S, X-SMALL	\$3.99
46584-431	TUNIC, CELEBRATION PINK, SLOVER, WOMEN'S, X-SMALL	\$0.99
46586-431	TUNIC, CELEBRATION PINK, PRINCESS TUNIC, WOMEN'S, X-SMALL	\$0.99
46587-HC1	TUNIC, HOUSE CALL PRINT, SNAP V, WOMEN'S, X-SMALL	\$0.99
46576-431	TUNIC, CELEBRATION PINK, EASY-OUT, WOMEN'S, X-SMALL	\$0.99
46576-511	TUNIC, ARIEL TEAL, EASY-OUT, WOMEN'S, X-SMALL	\$0.99
46576-681	TUNIC, GARDENA, EASY-OUT, WOMEN'S, X-SMALL	\$0.99
46576-701	TUNIC, INCA, EASY-OUT, WOMEN'S, X-SMALL	\$0.99
46576-781	TUNIC, VINTAGE FLORAL, EASY-OUT, WOMEN'S, X-SMALL	\$0.99

STOP BY THE CLOSEOUT SECTION ON OUR WEBSITE, AND SAVE YOURSELF SOME MONEY!

WWW.SHOPMEDVET.COM/CLOSEOUT-PRODUCTS

Images are used for graphic representation only actual product may be different. Please Inquire

CLOSEOUT Labcoats not included in 99¢ Scrubs special

13822 WEST BOULTON BLVD. METTAWA, IL 60045

WWW.SHOPMEDVET.COM

Phone 800-544-7521

194

Fax 800-204-2177

TUNICS MED-VET'S

SCRUBS DEPOT

CLOSEOUT LIMITED SUPPLY

As Low As 99¢ CLOSEOUT Scrubs While Supplies Last!



BUY NOW

BUY NOW

X-SMALL

46583-171	TUNIC, MARINE BLUE, SQUARE NECK, WOMEN'S, X-SMALL	\$0.99
46583-1S1	TUNIC, SOUTH SEA GREEN, SQUARE NECK, WOMEN'S, X-SMALL	\$0.99
46583-511	TUNIC, ARIEL TEAL, SQUARE NECK, WOMEN'S, X-SMALL	\$0.99
TNXS	TUNIC, NAVY, X-SMALL	\$0.99
TTRXS-SF	TUNIC, TEA ROSE, X-SMALL, SNAP FRONT	\$0.99

SMALL

33082L3	TUNIC, TEAL, CROSSOVER, REVERSIBLE, SMALL	\$0.99
46576-113	TUNIC, CEIL BLUE, EASY-OUT, WOMEN'S, SMALL	\$0.99
46576-123	TUNIC, MISTY GREEN, EASY-OUT, WOMEN'S, SMALL	\$0.99
46576-143	TUNIC, WILD PLUM, EASY-OUT, WOMEN'S, SMALL	\$0.99
46576-1B3	TUNIC, BORDEAUX, EASY-OUT, WOMEN'S, SMALL	\$0.99
46576-1L3	TUNIC, TEAL, EASY-OUT, WOMEN'S, SMALL	\$0.99
46583-523	TUNIC, ARIEL GREEN, SQUARE NECK, WOMEN'S, SMALL	\$0.99
46586-433	TUNIC, CELEBRATION PINK, PRINCESS TUNIC, WOMEN'S, SMALL	\$0.99
46587-0101	TUNIC, TEAL, SNAP FRONT, WOMEN'S, SMALL	\$0.99
46835-DR3	TUNIC, DUSTY ROSE, UNISEX, SMALL	\$0.99
46836-PL3	TUNIC, PLUM, PRINCESS TUNIC, WOMEN'S, SMALL	\$0.99
46870-2L3	TUNIC, TEAL, CROSSOVER, UNISEX, SMALL	\$0.99
HX3462-2L3	TUNIC, TEAL, SQUARE NECK, WOMEN'S, SMALL	\$0.99
46576-433	TUNIC, CELEBRATION PINK, EASY-OUT, WOMEN'S, SMALL	\$0.99
TTPS	TUNIC, TEAL PRINT, SMALL	\$0.99
TTOYS	TUNIC, TOY STORE PRINT, SMALL	\$0.99
TGPSGS	TUNIC, GRAPE W/SEA GREEN, SMALL	\$0.99
THGRBS	TUNIC, HUNTER GREEN W/ROYAL BLUE, SMALL	\$0.99
THSS	TUNIC, HUNTER SPLASH, SMALL	\$0.99

SMALL

TJGS	TUNIC, JADE GREEN, SMALL	\$0.99
TMGS	TUNIC, MISTY GREEN, SMALL	\$0.99
46584-103	TUNIC, WHITE, SLOVER, WOMEN'S, SMALL	\$0.99
46584-513	TUNIC, ARIEL TEAL, SLOVER, WOMEN'S, SMALL	\$0.99
46583-533	TUNIC, ARIEL PINK, SQUARE NECK, WOMEN'S, SMALL	\$3.99
46576-103	TUNIC, WHITE, EASY-OUT, WOMEN'S, SMALL	\$0.99
46576-673	TUNIC, KALEIDOSCOPE, EASY-OUT, WOMEN'S, SMALL	\$0.99
46581-533	TUNIC, ARIEL PINK, SILHOUETTE, WOMEN'S, SMALL	\$0.99
46582-513	TUNIC, ARIEL TEAL, SIDE TIE, WOMEN'S, SMALL	\$0.99
46883-173	TUNIC, MARINE BLUE, LONG SLEEVE, UNISEX, SMALL	\$0.99
TOBSGS	TUNIC, OCEAN BLUE W/SEA GREEN, SMALL	\$0.99
TGSGS	TUNIC, GRAPE W/SEA GREEN, SMALL	\$4.99
46576-1A3	TUNIC, AZALEA PINK, EASY-OUT, WOMEN'S, SMALL	\$0.99
46583-513	TUNIC, ARIEL TEAL, SQUARE NECK, WOMEN'S, SMALL	\$0.99

MEDIUM

46576-115	TUNIC, CEIL BLUE, EASY-OUT, WOMEN'S, MEDIUM	\$0.99
46576-125	TUNIC, MISTY GREEN, EASY-OUT, WOMEN'S, MEDIUM	\$0.99
46583-1L5	TUNIC, TEAL, SQUARE NECK, WOMEN'S, MEDIUM	\$0.99
46583-525	TUNIC, ARIEL GREEN, SQUARE NECK, WOMEN'S, MEDIUM	\$0.99
46587-0102	TUNIC, TEAL, SNAP FRONT, WOMEN'S, MEDIUM	\$0.99
HX3462-2L5	TUNIC, TEAL, SQUARE NECK, WOMEN'S, MEDIUM	\$0.99
46576-1L5	TUNIC, TEAL, EASY-OUT, WOMEN'S, MEDIUM	\$0.99
46581-1A5	TUNIC, AZALEA PINK, SILHOUETTE, WOMEN'S, MEDIUM	\$0.99
46581-655	TUNIC, WATERCOLOR CORAL, SILHOUETTE, WOMEN'S, MEDIUM	\$3.99
46583-425	TUNIC, CELEBRATION WHITE, SQUARE NECK, WOMEN'S, MEDIUM	\$0.99
46582-425	TUNIC, CELEBRATION WHITE, SIDE TIE, WOMEN'S, MEDIUM	\$0.99

CLOSEOUT Labcoats not included in 99¢ Scrubs special

13822 WEST BOULTON BLVD. METTAWA, IL 60045

WWW.SHOPMEDVET.COM

Phone 800-544-7521

195

Fax 800-204-2177

TUNICS MED-VET'S SCRUBS DEPOT

CLOSEOUT LIMITED SUPPLY

As Low As 99¢ CLOSEOUT Scrubs While Supplies Last!

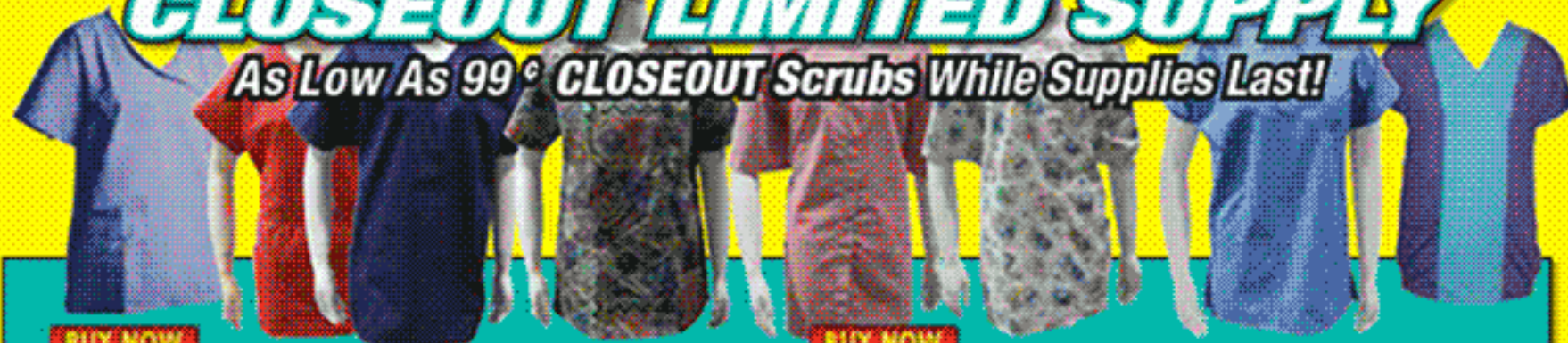

BUY NOW

BUY NOW

LARGE

46576-117	TUNIC, CEIL BLUE, EASY-OUT, WOMEN'S, LARGE	\$0.99
46576-437	TUNIC, CELEBRATION PINK, EASY-OUT, WOMEN'S, LARGE	\$0.99
46584-437	TUNIC, CELEBRATION PINK, SLOVER, WOMEN'S, LARGE	\$3.99
46576-107	TUNIC, WHITE, EASY-OUT, WOMEN'S, LARGE	\$0.99
46576-137	TUNIC, GREEN, EASY-OUT, WOMEN'S, LARGE	\$3.99
46583-1N7	TUNIC, NAVY, SQUARE NECK, WOMEN'S, LARGE	\$0.99
46886-177	TUNIC, MARINE BLUE, BASEBALL, UNISEX, LARGE	\$0.99
46584-517	TUNIC, ARIEL TEAL, SLOVER, WOMEN'S, LARGE	\$3.99

XX-LARGE

46576-1B2X	TUNIC, BORDEAUX, EASY-OUT, WOMEN'S, XX-LARGE	\$0.99
46576-CB2X	TUNIC, CELEBRATION BLUE, EASY-OUT, WOMEN'S, XX-LARGE	\$0.99
46584-432X	TUNIC, CELEBRATION PINK, SLOVER, WOMEN'S, XX-LARGE	\$0.99
46586-432X	TUNIC, CELEBRATION PINK, PRINCESS TUNIC, WOMEN'S, XX-LARGE	\$0.99
TCBXXL-SF	TUNIC, CIEL BLUE, SNAP FRONT, XX-LARGE	\$0.99
46854-RB2X	TUNIC, REGATA BLUE, BASEBALL, UNISEX, XX-LARGE	\$3.99

X-LARGE

46576-119	TUNIC, CEIL BLUE, EASY-OUT, WOMEN'S, X-LARGE	\$0.99
46576-1B9	TUNIC, BORDEAUX, EASY-OUT, WOMEN'S, X-LARGE	\$0.99
46576-1L9	TUNIC, TEAL, EASY-OUT, WOMEN'S, X-LARGE	\$0.99
46583-529	TUNIC, ARIEL GREEN, SQUARE NECK, WOMEN'S, X-LARGE	\$0.99
46587-0104	TUNIC, TEAL, SNAP FRONT, WOMEN'S, X-LARGE	\$0.99
46587-529	TUNIC, ARIEL GREEN, SNAP V, WOMEN'S, X-LARGE	\$0.99
46835-DR9	TUNIC, DUSTY ROSE, UNISEX, X-LARGE	\$0.99
HX3462-2L9	TUNIC, TEAL, SQUARE NECK, WOMEN'S, X-LARGE	\$0.99
TRGPXL	TUNIC, ROYAL/GRAY PRINT, X-LARGE	\$0.99
46587-169	TUNIC, PAFRAT PINK, SNAP V, WOMEN'S, X-LARGE	\$3.99
46587-439	TUNIC, CELEBRATION PINK, SNAP V, WOMEN'S, X-LARGE	\$3.99
46587-609	TUNIC, PERFECT PANSY, SNAP V, WOMEN'S, X-LARGE	\$3.99
46576-109	TUNIC, WHITE, EASY-OUT, WOMEN'S, X-LARGE	\$0.99

XXX-LARGE

33082L3X	TUNIC, TEAL, CROSSOVER, REVERSIBLE, XXX-LARGE	\$0.99
46586-433X	TUNIC, CELEBRATION PINK, PRINCESS TUNIC, WOMEN'S, XXX-LARGE	\$0.99
46587-0106	TUNIC, TEAL, SNAP FRONT, WOMEN'S, XXX-LARGE	\$0.99
46587-513X	TUNIC, ARIEL TEAL, SNAP V, WOMEN'S, XXX-LARGE	\$0.99
HX3462-2L3X	TUNIC, TEAL, SQUARE NECK, WOMEN'S, XXX-LARGE	\$0.99
46586-523X	TUNIC, ARIEL GREEN, PRINCESS TUNIC, WOMEN'S, XXX-LARGE	\$0.99
46576-103X	TUNIC, WHITE, EASY-OUT, WOMEN'S, XXX-LARGE	\$0.99
46586-513X	TUNIC, ARIEL TEAL, PRINCESS TUNIC, WOMEN'S, XXX-LARGE	\$0.99
46583-423X	TUNIC, CELEBRATION WHITE, SQUARE NECK, WOMEN'S, XXX-LARGE	\$0.99
46587-153X	TUNIC, KHAKI, SNAP V, WOMEN'S, XXX-LARGE	\$0.99
46581-1A3X	TUNIC, AZALEA PINK, SILHOUETTE, WOMEN'S, XXX-LARGE	\$0.99

XXXXX-LARGE

46587-525X	TUNIC, ARIEL GREEN, SNAP V, WOMEN'S, XXXXX-LARGE	\$3.99
------------	--	--------

**SIGN UP FOR WEEKLY PHARMACEUTICAL SPECIALS
& BUY ONE GET ONE FREE DEALS @ WWW.SHOPMEDVET.COM**

CLOSEOUT Labcoats not included in 99¢ Scrubs special

13822 WEST BOULTON BLVD. METTAWA, IL 60045

Phone 800-544-7521

196

WWW.SHOPMEDVET.COM

Fax 800-204-2177

WARM-UPS**MED-VET'S**

SCRUBS DEPOT

CLOSEOUT LIMITED SUPPLY

As Low As 99¢ CLOSEOUT Scrubs While Supplies Last!**BUY NOW****BUY NOW****X-SMALL**

46589-141	WARM-UP, PLUM, TRADITIONAL, WOMEN'S, X-SMALL	\$0.99
46589-431	WARM-UP, CELEBRATION PINK, TRADITIONAL, WOMEN'S, X-SMALL	\$0.99
46590-171	WARM-UP, MARINE BLUE, COMFORT PLUS, WOMEN'S, X-SMALL	\$0.99
46589-1A1	WARM-UP, AZALEA PINK, TRADITIONAL, WOMEN'S, X-SMALL	\$0.99
46589-661	WARM-UP, PERFECT PANSY, TRADITIONAL, WOMEN'S, X-SMALL	\$0.99
46859-FF1	WARM-UP, FALL FOLIAGE, UNISEX, X-SMALL	\$0.99
46590-161	WARM-UP, PARFAIT PINK, COMFORT PLUS, WOMEN'S, X-SMALL	\$0.99
46590-141	WARM-UP, WILD PLUM, COMFORT PLUS, WOMEN'S, X-SMALL	\$0.99
WUTURXS	WARM-UP, TURQUOISE, X-SMALL	\$0.99
46593-171	WARM-UP, MARINE BLUE, STAND UP COLLAR, WOMEN'S, X-SMALL	\$3.99

SMALL

46819-123	WARM-UP, MISTY, UNISEX, SMALL	\$0.99
46859-FF3	WARM-UP, FALL FOLIAGE, UNISEX, SMALL	\$0.99
WUMGS	WARM-UP, MISTY GREEN, SMALL	\$0.99
46593-703	WARM-UP, INCA, STAND UP COLLAR, WOMEN'S, SMALL	\$0.99
46864-133	WARM-UP, GREEN, CYCLOAT, UNISEX, SMALL	\$0.99

MEDIUM

46589-0194	WARM-UP, TEAL, TRADITIONAL, WOMEN'S, MEDIUM	\$0.99
46593-705	WARM-UP, INCA, STAND UP COLLAR, WOMEN'S, MEDIUM	\$0.99
46593-675	WARM-UP, KALEIDOSCOPE, STAND UP COLLAR, WOMEN'S, MEDIUM	\$3.99
46589-625	WARM-UP, RAVINA MISTY, TRADITIONAL, WOMEN'S, MEDIUM	\$3.99

LARGE

46839-PL7	WARM-UP, PLUM, TRADITIONAL, WOMEN'S, LARGE	\$0.99
-----------	--	--------

X-LARGE

46590-149	WARM-UP, WILD PLUM, COMFORT PLUS, WOMEN'S, X-LARGE	\$3.99
46859-VG9	WARM-UP, VIOLET GARDEN, UNISEX, X-LARGE	\$0.99

XX-LARGE

46589-142X	WARM-UP, PLUM, TRADITIONAL, WOMEN'S, XX-LARGE	\$0.99
46819-122X	WARM-UP, MISTY, UNISEX, XX-LARGE	\$0.99
46879-212X	WARM-UP, CEIL BLUE, UNISEX, XX-LARGE	\$0.99
46589-522X	WARM-UP, ARIEL GREEN, TRADITIONAL, WOMEN'S, XX-LARGE	\$0.99
46593-702X	WARM-UP, INCA, STAND UP COLLAR, WOMEN'S, XX-LARGE	\$3.99

XXX-LARGE

46819-123X	WARM-UP, MISTY, UNISEX, XXX-LARGE	\$0.99
WUHGXXXL	WARM-UP, HUNTER GREEN, XXX-LARGE	\$5.99

XXXX-LARGE

3270-134X	WARM-UP, JADE GREEN, KALM OHIO HEALTH, XXXX-LARGE	\$0.99
-----------	---	--------

XXXX-LARGE

46819-125X	WARM-UP, MISTY, UNISEX, XXXXX-LARGE	\$0.99
------------	-------------------------------------	--------

**SIGN UP FOR WEEKLY PHARMACEUTICAL SPECIALS
& BUY ONE GET ONE FREE DEALS @ WWW.SHOPMEDVET.COM**

CLOSEOUT Labcoats not included in 99¢ Scrubs special

13822 WEST BOULTON BLVD. METTAWA, IL 60045

WWW.SHOPMEDVET.COM**Phone 800-544-7521**

197

Fax 800-204-2177

Vials & Containers

Ovals, Prescription Vials, Sharps & Dropper Bottles

Amber Plastic Graduated Ovals

Amber Plastic Graduated Ovals with twist off child resistant caps. Lightweight transparent amber ovals graduated in ounces and milliliters.

OVAL2	2 oz 200/cs	\$41.29/cs
OVAL4	4 oz 200/cs	\$48.00/cs
OVAL6	6 oz 100/cs	\$34.00/cs
OVAL8	8 oz 100/cs	\$37.21/cs
OVAL12	12 oz 100/cs	\$41.00/cs
OVAL16	16 oz 50/cs	\$34.19/cs



BUY NOW

Amber Prescription Safety Cap Vials

High Quality. Tight and light resistant amber vials are excellent for dispensing medication. Available in a large variety of sizes. Each case has 100% Child Resistant Caps with 10% Snap Caps.

VAL60	Height 6.6cm (2.6") Diameter 2.55cm (1") 6 Dram, 600/cs	\$43.98/cs
VAL80	Height 6.6cm (2.6") Diameter 2.55cm (1") 8 Dram, 410/cs	\$33.04/cs
VAL130	Height 6.4cm (2.5") Diameter 3.1cm (1.22") 13 Dram, 320/cs	\$36.04/cs
VAL160	Height 7.9cm (3.1") Diameter 3.1cm (1.22") 16 Dram, 270/cs	\$37.76/cs
VAL200	Height 6.3cm (2.5") Diameter 4.1cm (1.6") top, 3.5cm (1.4") bottom, 20 Dram, 360/cs	\$53.12/cs
VAL300	Height 9.1cm (3.6") Diameter 4.1cm (1.6") top, 3.5cm (1.4") bottom, 30 Dram, 240/cs	\$43.64/cs
VAL400	Height 9.5cm (3.7") Diameter 4.6cm (1.8") top, 4.2cm (1.7") bottom, 40 Dram, 180/cs	\$36.29/cs
VAL600	Height 6.6cm (2.6") Diameter 2.55cm (1") 60 Dram, 115/cs	\$33.04/cs



BUY NOW

Blue Vials (Safety Cap Vials)

VAL60-B	Height 6.2cm (2.44") Diameter 2.2cm (.866") 6 Dram, Blue, 600/cs	\$43.98/cs
VAL80-B	Height 6.25cm Ground/finish 2cm, 8 Dram, Blue, 410/cs	\$33.05/cs
VAL130-B	Height 6.4cm (2.5") Diameter 3.1cm (1.22") 13 Dram, Blue, 320/cs	\$36.04/cs
VAL160-B	Height 7.9cm (3.1") Diameter 3.1cm (1.22") 16 Dram, Blue, 270/cs	\$37.76/cs
VAL200-B	Height 6.3cm (2.5") Diameter 4.1cm (1.6") top, 3.5cm (1.4") bottom, 20 Dram, Blue, 360/cs	\$53.12/cs
VAL300-B	Height 9.1cm (3.6") Diameter 4.1cm (1.6") top, 3.5cm (1.4") bottom, 30 Dram, Blue, 240/cs	\$43.64/cs
VAL400-B	Height 9.5cm (3.7") Diameter 4.6cm (1.8") top, 4.2cm (1.7") bottom, 40 Dram, Blue, 180/cs	\$36.29/cs
VAL600-B	Height 13.2cm (5.2") Diameter 4.6cm (1.8") top, 4.2cm (1.7") bottom, 60 Dram, Blue, 115/cs	\$33.04/cs



BUY NOW

Plastic Gallon Bottle with Screw Top

Plastic Gallon Bottle with Screw Top
140503 1 Gal W/Screw Top

\$1.79/ea

BUY NOW

Spray Bottle

140501	16oz	\$1.89/btl
140502	32oz	\$1.99/btl

BUY NOW



TOP SELLER



Sharps Containers

BUY NOW

For safe disposal of sharps in restricted access areas. Versatile lid accommodates contaminated items of various sizes. Constructed of puncture resistant polypropylene. Locking top flap. Easy to assemble. Meets all EPA and OSHA standards. Nestable containers save space and reduce shipping costs.



SHARP-10	1 Quart	\$1.99/ea
SHARP-1G	1 gallon	\$2.50/ea
SHARP-2G	2 gallons	\$3.79/ea
SHARP-4G	4 gallon	\$6.95/ea
SHARP-10G	10 gallons	\$12.99/ea
SHARP-16G	16 gallons	\$29.00/ea

TOP SELLER

**Starting At
\$1.99/ea**

BUY NOW

Jorvet Sharp's Container

Veterinarians increasingly understand the need to be in compliance with government regulations from agencies like OSHA and the EPA. These regulations require proper disposal of medical waste in containers specifically designed for such use. These red plastic containers are especially designed for easy and proper disposal of items such as hypodermic needles, suture needles, and scalpel blades. The top lid has a special slot that helps removal of hypodermic needles from their hub. When the container is completely full, the lid seals permanently and tightly for proper disposal.

JOR886	4 liter	\$3.30/ea
JOR886A	0.5 Liter	\$2.10/ea

Jorvet



Amber Dropper Bottle

BUY NOW

Plastic amber bottles with dropper caps that can be removed to administer treatment or to allow refilling. Shows ounce and mL markings on bottles and dropper. 12 per box.

DB.5	1/2 Ounce 12/Box	\$9.46/bx
DB1	1 Ounce 12/Box	\$9.53/bx
DB2	2 Ounce 12/Box	\$9.38/bx

TOP SELLER



Jorvet Plastic Medicine Dropper

with blue rubber bulb. Graduated in milliliters and teaspoons. 2.5ml (1/2 tsp.) 5/pk.

JOR824C	2 1/2ml, 5 Pack	\$12.75/pk
---------	-----------------	------------

BUY NOW

Jorvet



Jorvet Glass Eye Dropper

With black rubber bulb. Handy for giving medication orally or into eyes or ears. Especially for smaller pets or exotics. 1ml calibrated. 5/pk.

JOR824	1-ml, 5 Pack	\$11.70/pk
--------	--------------	------------

BUY NOW



Vials & Containers

Sundry Jars

Sundry Jars

BUY NOW

These deluxe sundry jars feature unbreakable plastic in either white opaque or clear polystyrene. Jars are permanently labeled in blue and come with clear lids for easy viewing.

39-800	White Opaque 5/Set Labels: Applicators, Bandages, Cotton, Gauze & Tongue Depressors.	\$22.00/ea
39-802	Clear 5/Set, Labels: Applicators, Bandages, Cotton, Gauze & Tongue Depressors.	\$29.99/ea
39-803	Clear, Each, Unlabeled	\$5.00/ea



Jorvet Sundry Jars Clear Tops

BUY NOW

5/Set. Acrylic. Features clear tops and bases. 4 3/4" dia. x 6 1/2"H. (Wall Rack sold separately)

JOR619	Set of 5, Clear	\$36.00/ea
--------	-----------------	------------

JOR619
JOR619R

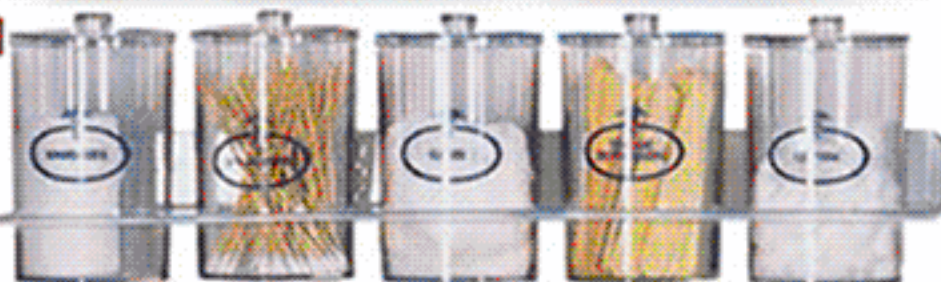

Jorvet Sundry Jar Wall Rack

Plexiglass Wall Rack.

JOR619R	\$68.50/ea
---------	------------

BUY NOW

Jorvet Glass Sundry Jars



JOR619H	Applicator	\$11.70/ea
JOR619J	Bandage	\$10.50/ea
JOR619K	Cotton	\$11.70/ea
JOR619N	Gauze	\$11.70/ea
JOR619M	Tongue depressor	\$11.70/ea

JOR619H-M
JOR619H Unlabeled



Jorvet Sundry Glass Jars

BUY NOW

Set of five unlabeled plain glass jars. *Not Shown*

JOR619X	Unlabeled, set of 5	\$38.25/pk
---------	---------------------	------------

Sundry Jar w/Cartoon Characters

Front panel labels with funny cartoons. Opaque bases.

Jorvet

BUY NOW

JOR619C	5/Set, 4" dia. x 6 1/2"H. Acrylic.	\$67.00/ea
---------	------------------------------------	------------



Jorvet Alcohol Dispenser

This handy pump bottle dispenses alcohol by pressing down on the top lid. Great for use in the exam room for alcohol wipes, pre-injection in vaccinations. 8 oz. clear/white polypropylene bottle.

JOR614	8 oz	\$12.00/ea
--------	------	------------

BUY NOW



Jorvet P-Cup

BUY NOW

P-Cup Urinary Retriever. Getting a decent urine sample from canine patients is a challenging endeavor. The "P" Cup was designed to ease this challenge. It consists of flexible twin metal rods that hold a sterile, shallow plastic specimen dish. The 19" length allows the sample container to be slipped under the patient when they stop to urinate.

JOR889	Complete	\$6.40/ea
JOR88901	P-cup only, Sterile, 6pk	\$7.95/pk



13822 WEST BOULTON BLVD. METTAWA, IL 60045

WWW.SHOPMEDVET.COM

Phone 800-544-7521

199

Fax 800-204-2177

Vials & Containers

Dropper Bottles, Ointment Jars & Pill Supplies

Yorker Dropper Bottle

BUY NOW

Removable dropper tips allow refilling. Bottle and tips are made of low density polyethylene. Screw cap made of polystyrene. 12 per box.

97-5015	15ml 12/Box	\$4.80/bx
97-5030	30ml 12/Box	\$5.60/bx
97-50 60	60ml 12/Box	\$6.20/bx
97-5125	125ml 12/Box	\$9.00/bx



Ointment Jars

BUY NOW

Plastic ointment jars in sizes from 1 oz. to 16 oz. Approx. diameter 1 1/8", height 2 3/4"

OJ1	1 oz 48/cs	\$16.57/cs
OJ2	2 oz 48/cs	\$20.94/cs
OJ4	4 oz 48/cs	\$26.19/cs
OJ8	8 oz 4 8/cs	\$31.75/cs
OJ16	16 oz 24/cs	\$33.22/cs



TOP SELLER

Plastic Squeeze Bottle with Flip Top

B199N	White, 16 oz, 2.5" Diameter, 8" High	\$1.15/ea
B302	White, 8 oz, 2.5" Diameter, 6.5" High	\$0.85/ea
B359	White, 4 oz, 1.5" Diameter, 5.5" High	\$0.70/ea

NEW BUY NOW



Specimen Container

BUY NOW

Clear plastic with screw caps, frosted label & graduation showing ounces and mLs.

30330	4oz Sterile 100/cs	\$22.00/cs
30335	4oz Non-Sterile 500/cs	\$49.50/cs

TOP SELLER



Jorvet Sterile Disposable Specimen Container

Graduated specimen container. A leak proof lid. Wide base for stable reliable use. Seal/label assures internal sterility. Green cap.

JOR555	4 oz., (120ml), 100/bag	\$28.50/bg
JOR555NS	4 oz., 100, Non-Sterile	\$24.30/cs

BUY NOW

Jorvet



Souffle Cup

Souffle Cups: Pleated portions are made of one-piece, dry-waxed construction for durability. Rims are lightly rolled for rigidity, and the base is recessed to prevent tipping. Cup doubles as a drinking cup. 3/4 oz.

NOW024215	Souffle cup 3/4 oz 250/bx	\$3.40/bx
-----------	---------------------------	-----------

BUY NOW



Jorvet Fecal Specimen Container with Spoon

A proper fecal exam is an essential part of any wellness program. However getting proper owner compliance is a challenge. The Jorvet fecal specimen containers are an effective way to help assist the pet owner in getting a quality stool sample.

- Clear plastic vial-can readily see sample
- Snap on lid-easy for clients i.e. geriatric to close container
- Flat bottom-can stand right up.
- Spoon attached to cap-can get stool sample with proper hygiene
- Patient stick on label-identifies proper client and patient
- Inexpensive-great for dispensing to client

Note: not designed for use as a floatation chamber

BUY NOW



JOR1069	Specimen container 18ml w/spoon push cap.	\$25.50/bg
---------	---	------------

Pill Envelope

BUY NOW

PILL-E 2 1/2" x 4 1/4", 500/bx

\$19.95/bx

TOP SELLER



Jorvet Pill Envelopes

BUY NOW

Heavy weight tan paper stock with gummed flaps. Imprinted with standard prescription to fill in. Convenient for small pill quantities.

JOR934	3 1/2" x 2 1/4", 100/box	\$23.40/bx
--------	--------------------------	------------

Jorvet



Jorvet Pharmacy Folding Cartons

Inexpensive pill dispensing cartons. Heavy white paper board with marked "directions". 100/pkg

BUY NOW

JOR933A	Small, 1 1/4" x 2 1/4" x 1 5/16"	\$21.00/pkg
JOR933B	Medium, 2 1/2" x 1 1/2" x 3/4"	\$30.50/pkg



Pill Crusher-Splitter

BUY NOW

Crushes pills to a fine powder Splits pills in halves or quarters. Separate twin compartment to store dry medicine. Great size for travel, fits in your purse. Heavy duty plastic.

EZPILL	split/crush	\$6.95/ea
--------	-------------	-----------



Jorvet 7-day Pill Case

Jorvet

BUY NOW

Certain medications like thyroid, heart and epilepsy treatments need to be given every day to be effective. This pill case is a great aid for increasing owner compliance in administering medications. It is clearly labeled for "Pets Only," and shrink wrapped on an attractive display card.

JOR823	Labeled "Pets Only"	\$1.30/ea
--------	---------------------	-----------

S M T W T F S

13822 WEST BOULTON BLVD. METTAWA, IL 60045

WWW.SHOPMEDVET.COM

Phone 800-544-7521

200

Fax 800-204-2177

Vials & Containers

Bio Hazard Supplies, Pet Carrier & Cadaver Bags



Cadaver Bag

BUY NOW

Made from extra heavy duty black 3 mil, Polyethylene. Sold individually. 100 bags per roll. Dispenser sold separately.

CB2436	24" x 36" 3mil	\$0.50/ea	100+\$0.45/ea
CB3048	30" x 48" 3mil	\$0.77/ea	100+\$0.67/ea
CB4050	40" x 50" 3mil	\$0.95/ea	100+\$0.85/ea



Jorvet Cadaver Bags

BUY NOW

Heavy-duty 4 mil black plastic. Strong enough to handle the sanitary disposal of animals. Full 35" x 48". 25 bags/pk. (not pictured)

JOR108	25 pack	\$28.00/pk
--------	---------	------------



Drape Dispenser

BUY NOW

Dispenser also available, for full roll quantities*. Can be desk or wall mounted. *Note: For dispenser to be utilized, you must order the entire roll. Only rolls are shipped with the cores necessary for dispenser use.

H29	24" Each	\$21.95/ea
-----	----------	------------



Bio Hazardous Disposable Pouches

Safely contain sharp-edged objects like scalpel blades and needles for disposal. The 10mm thick paperboard folds to an oval shape. The bottom is secured by double-sided tape on one flap. The fold-down top secures bag when full. English instructions on front, Spanish on back. Inexpensive. 5 1/2" x 13". 100 pouch/pk.

Shown with JOR724H Sold Separately

JOR723	100pk	\$72.20/pk
--------	-------	------------

BUY NOW

BioHazardous Pouch Stand

Epoxy-Coated Steel Wire Stand attractively holds pouch. Put one in every exam room.

JOR723H	Each	\$19.20/ea
---------	------	------------

BUY NOW



BioHazard Bags

Handy size bag and holder are ideal for collecting lab samples like blood tubes. Bag stays open until you are ready to dispose of it. These 1.5mm thick polypropylene bags can be safely autoclaved. An indicator patch darkens when sterilized. Very inexpensive.

JOR724	3.6" x 5.1" x 8.4" 100/pk.	\$21.60/pk
--------	----------------------------	------------

BUY NOW

BioHazard Bag Holder

Epoxy-Coated Steel Wire Holder.

JOR724H	Each	\$20.70/ea
---------	------	------------

BUY NOW

Pet Carrier

BUY NOW

- 200 lbs test white cardboard
- 17"L x 12 3/4"H x 8"W
- Special water based coating provides moisture resistance.
- Safe, no staples, strong glued joints and extra ventilation.
- Recyclable, approximately 70% post-consumer recycled product.
- Printed warning "Do not leave animal(s) unattended in carrier."
- Easy assembly instructions on carriers. Easy one-piece construction.
- Sold by the dozen.



PET-C	12/Case	\$34.50/cs
-------	---------	------------

Pocket Pet Carrier for Small Animals

- 200 lbs test white cardboard
- 10"L x 6 3/4"H x 5 1/2"W.
- Safe, no staples, strong glued joints and extra ventilation.
- Recyclable, approximately 70% post-consumer recycled product.
- Easy assembly instructions on carriers.
- Easy one-piece construction.
- Sold by the dozen.

PET-PC	12/Case	\$13.75/cs
--------	---------	------------



BioHazard Waste Disposal

"Touch Free" Jorvet

BUY NOW

2.5 gallons, white perfect for benchtop use and includes a removable rigid liner that won't leak or rust.

JOR991	2 1/2 gallon, "Touch Free"	\$79.00/ea
--------	----------------------------	------------

JOR991A	7.3 gallon, each, "Touch Free"	\$139.00/ea
---------	--------------------------------	-------------



Jorvet Biohazard Disposal Bags

Orange-red. Look for the sterilization indicator patch. The days have passed when veterinarians simply disposed of their hazardous waste like surgery gloves, drape, and animal body parts in the trash. Medical standards require responsible disposal of medical waste in appropriately marked bags that can be safely autoclaved. A large biohazard symbol and precautionary in four languages are clearly visible for safety. Made of high molecular weight, high density (HMHD) polyethylene and are steam autoclavable up to 121°C (250°F).

JOR1067	2-4 gallon, 50pk	\$48.60/pk
---------	------------------	------------

JOR1067A	6-9 gal, 50pk	\$61.50/pk
----------	---------------	------------

JOR1067B	20-30 gal, 50pk	\$123.00/pk
----------	-----------------	-------------



Intravenous Products

IV Sets, T-Connectors & IV Stands

IV Extension Set

IVEXTINJ 30" With Injection Site \$0.75/ea **100+\$0.50¢/ea** **TOP SELLER**

BUY NOW

Jorvet T-Port Small Bore Extension Set

This set is different in that the "T" port itself is needle free. It will accept male luer lock and slip connections. Male spin luer lock. Micro bore tubing. Female luer lock. 5" length (12.7cm). 0.3ml priming volume. Slide clamp.

JOR467G \$3.70/ea

JorVet

BUY NOW

Jorvet 3-way Stopcock Attached to Male Barbed Fitting

Three-Way Stopcock permanently attached to male-barbed connector. Stopcock has two female luer connectors that can be attached to: a luer syringe, IV-set, or "T" bore connector. The barbed connector can be attached to: Foley, or other catheters, chest drain, or small stomach tubes.

JOR599X Sterile \$6.50/ea

BUY NOW

Jorvet Discifix 3-Way Stop Cock

Directional flow knob is labeled with "off." This is useful in recognizing flow direction. Sterile.

JOR462 \$0.96/ea

BUY NOW

Jorvet IV Extension Set w/Stopcock

With three-way stopcock. One end female luer slip and the other end is a male spin luer lock. Sterile.

JOR1039 \$2.95/ea

JorVet

BUY NOW

Injection Cap

Sterile, single use. Compatible with all I.V. Catheters. Ideal for use as a catheter plug. Luer lock.

INJCAP Each \$0.50/ea

BUY NOW

Jorvet Danish IV Needle

Intravenous Needle with case.

JOR50B 3" Shaft, 3mm (~11g) \$27.00/ea
 JOR50A 3" Shaft, 2.5mm (~14g) \$25.50/ea
 JOR50C 3" Shaft, 3mm (~7g) \$45.00/ea

JorVet

BUY NOW

IV Administration Set

BUY NOW

Our IV sets features Universal kink resistant tubing with smooth action roller clamp, and Y injection site. Available in 10, 15, 20 and 60 drop per mL sizes. Compatible with both bottles and bags.

IV10	10Dr/ml	100" With Injection Site	\$1.10/ea	100+\$0.85/ea
IV15	15Dr/ml	100" With Injection Site	\$1.10/ea	100+\$0.85/ea
IV20	20Dr/ml	72" With Injection Site	\$1.10/ea	100+\$0.85/ea
IV60	60Dr/ml	72" With Injection Site	\$1.10/ea	100+\$0.85/ea

IV T-Connector

BUY NOW

Distal end has a female luer fitting. Proximal end has male luer lock with latex injection port. Also slide clamp for control. Sterile. 6" length.

T-PORT	6" Standard Bore	\$1.95/ea	50+\$1.25/ea
T-PORT-MB	6" Microbore	\$1.95/ea	50+\$1.25/ea

Jorvet IV Extension Set w/Flow Control

With flow rate regulator This 19" extension set has an adjustable dial that controls the flow rate in ml/min. It has a female luer fitting on one end and a male spin luer lock on the other. A "Y" site is located just above below the controller.

JOR1038 \$4.80/ea

JorVet

BUY NOW

Jorvet IV Extension Set w/two Y Sites

- With two "Y" sites 32" length, with two slide clamps
- Male spin luer lock distal end
- Female luer lock proximal end

JOR1039A \$1.65/ea

BUY NOW

IV Stand

BUY NOW

Constructed of durable steel with a large 18" diameter, four-legged base for excellent stability. Two ram's horn style hooks; height adjusts from 47" to 85".

MPOLE	Each	\$39.99/ea
MPOLE-DELUXE	Each	\$89.50/ea Not Pictured

Jorvet Deluxe IV Stand

BUY NOW

24" dia. five-leg aluminum base is more stable than the economy model. Brushed chrome, dual caster, and four prong hooks.

JOR266	4 hooks, Adjustable 54"-84"H.	\$152.00/ea
JOR266A	2 hooks	\$150.00/ea

Jorvet Economy IV Stand with 2 Hooks

The stand features a 21" dia. painted base, open casters, a knurled twist lock, and a welded two-hook top. Adjustable 45"-83"H.

JOR266E \$60.00/ea

BUY NOW

Intravenous Products

Catheters & Infusion Sets

IV Catheter Vet Use

IVC14X2.25V	14 X 2.25" Vet Use 50/box	\$25.00/box
IVC16X2.25V	16 X 2.25" Vet Use 50/box	\$25.00/box
IVC20X1.25V	20 X 1.25" Vet Use 50/box	\$25.00/box
IVC22X1V	22 X 1" Vet Use 50/box	\$25.00/box
IVC24X3/4V	24 X 3/4" Vet Use 50/box	\$25.00/box

Butterfly Infusion Set

26702	12" tubing, 19g x 3/4", 50/box	\$19.30/box
26703	12" tubing, 20g x 3/4", 50/box	\$19.30/box
26704	12" tubing, 21g x 3/4", 50/box	\$19.30/box
26706	12" tubing, 23g x 3/4", 50/box	\$19.30/box
26708	12" tubing, 25g x 3/4", 50/box	\$19.30/box
26709	12" tubing, 27g x 3/4", 50/box	\$19.30/box

Butterfly Infusion Set

Latex free, individually packaged, small vein infusion set. The thin, stainless steel cannula is siliconized for easy insertion. They are sterilized with ethylene oxide and ready for immediate use. Flexible wings hold the needle in position and help to prevent inadvertent pull out.

D3K223G	12" tubing, 23g x 3/4", 50/box	\$24.95/box
D3K225G	12" tubing, 25g x 3/4", 50/box	\$24.95/box
D3K221G	12" tubing, 21g x 3/4", 50/box	\$24.95/box

Winged Infusion Set

Soft, color-coded wings have non-slip grip and safety dots for user protection, and PVC tubing is non-toxic and flexible. Broad range of sizes (27G, 19G) accommodates virtually any patient need.

PR18G19	18g x 3/4 12" tubing 50/box	\$14.99/box
PR21G19	21g x 3/4 12" tubing 50/box	\$14.99/box
PR19G19	19g x 3/4 12" tubing 50/box	\$14.99/box
PR23G19	23g x 3/4 12" tubing 50/box	\$14.99/box
PR25G19	25g x 3/4 12" tubing 50/box	\$14.99/box

Jorvet Large Animal IV Catheter

Large animals need large volumes of IV fluids in a short period of time. Naturally, the IV catheter needs to be a large bore, and often is even put in bilaterally to maximize fluid administration speed.

- Features:
- Large bore: 10g and 14g catheters. The 10g is the largest available.
 - Longer lengths: 51/2" catheter lessens the risk of pulling out the catheter.
 - Pebax® catheter implant grade material: much less bio-reactive to lessen thrombosis formation for long term >3 days placement.
 - Kink resistant: other catheters like Teflon will kink upon bending, making them unusable.
 - Clear catheter material versus opaque Teflon.
 - Suture patch: a thin, flexible patch with twin eyelets. Allows suturing in place or hold with tissue adhesives. Reduces catheter pull-out.
 - Competitive pricing and available through Jorvet distributors.

JOR457A	14g x 5.5	\$13.80/ea
JOR457B	10g x 5.5	\$12.30/ea

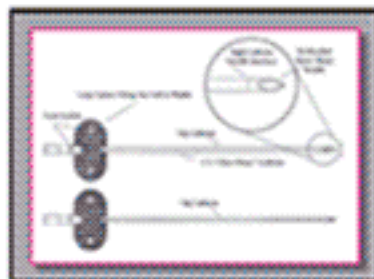

IV Catheter

Terumo IV Catheters

SR0X1451CA	14 X 2"	\$1.00/ea	50+\$0.90/ea
SR0X1632CA	16 X 1.25"	\$1.00/ea	50+\$0.90/ea
SR0X1651CA	16 X 2"	\$1.00/ea	50+\$0.90/ea
SR0X1664CA	16 X 2.5"	\$1.00/ea	50+\$0.90/ea
SR0X1864CA	18 X 2.5"	\$1.00/ea	50+\$0.90/ea
SR0X1832CA	18 X 1.25"	\$1.00/ea	50+\$0.90/ea
SR0X1851CA	18 X 2"	\$1.00/ea	50+\$0.90/ea
SR0X2025CA	20 X 1"	\$1.00/ea	50+\$0.90/ea
SR0X2032CA	20 X 1.25"	\$1.00/ea	50+\$0.90/ea
SR0X2051CA	20 X 2"	\$1.00/ea	50+\$0.90/ea
SR0X2225CA	22 X 1"	\$1.00/ea	50+\$0.90/ea
SR0X2419CA	24 X 3/4"	\$1.00/ea	50+\$0.90/ea

Extended Use Polyurethane Catheter

Most traditional jugular catheters are Teflon. They can create a thrombosis and crack if left in place for over 48 hours. The development of new materials allows large-bore catheters that can safely be left in-dwelling for up to 10 days. The JorJet Extended Use Catheter softens at body temperature. Many of the common catheter-related problems, such as phlebitis, can be minimized with these catheters.

- 14g and 16g polyurethane catheter over needle
- Non-thrombogenic and non-cracking
- Can be safely left in the vein for up to 10 days
- This same catheter is used in 24 out of 27 U.S. veterinary teaching hospitals

JOR458B	16g x 5 1/4"	\$11.10/ea
JOR458C	16g x 3", foal	\$11.40/ea
JOR458D	14g x 3 1/2", foal	\$11.40/ea
JOR458A	14g x 5 1/4"	\$11.10/ea

Plastic Urethral Catheter

Clear Vinyl Intermittent Self Catheters: Suitable for male or female catheterization. Smooth tip, comfort eyes and funnel end. Radiopaque. Male/Universal Clear Vinyl Intermittent Self Catheter.

DYND10700	14Fr, 16" Length.	\$55.00/cs
-----------	-------------------	------------

Jorvet IV Catheter Guard

There is nothing more frustrating than working hard to place an IV catheter in a critically ill patient only to have the patient remove it. The IV Catheter Guards are a quick and inexpensive way to deter your patients from chewing or licking on their IV catheters. They are made of a thin lightweight flexible plastic with holes for air circulation. The IV catheter guard is held in place by velcro straps that wrap around the limb. The rough surface of the velcro seems to deter most patients from licking. Straps are reusable, but also inexpensive to replace if damaged. University tested and recommended. Directions for Use: Select the correct size from the four sizes available. Loosen velcro straps. Place IVGuard over the catheter as shown. Wrap velcro straps around the leg and tighten on IV Guard. Soak or gently scrub with disinfectant solution or bleach between uses. Four sizes available!

JOR644S	set of 4	\$24.00/ea
JOR644	Small	\$5.10/ea
JOR644A	Medium	\$5.55/ea
JOR644B	Large	\$6.75/ea
JOR644C	X-large	\$7.80/ea



Intravenous Products

Central Venous Catheter Kit & Infusion Sets/Pumps

Jorvet Central Venous Catheter Kit

These long-term catheters have been the standard of critical care in human medicine for many years. The catheters are placed in the jugular vein using a technique called Seldinger. It uses a guide wire system.

- Non-reactive polyurethane catheter: can be left in place for extended use i.e. 3-4 weeks.
- Single, double or even triple lumen catheters of various lengths: allows administration concurrently of different IV medications.

Kit consists of:

- Polyurethane radiopaque catheter with clamp
- Introducer needle
- Vessel dilator
- Guide wire
- Injection caps
- 5ml syringe
- Illustrated directions



BUY NOW

JOR1040	20g X 8cm (3 1/4"), Single lumen	\$17.20/ea
JOR1040A	20g X 13cm (5 1/4"), Single lumen	\$17.20/ea
JOR1041	18g X 8cm (3 1/4"), Single lumen	\$17.20/ea
JOR1041A	18g X 13cm (5 1/4"), Single lumen	\$17.20/ea
JOR104 2	16g X 13cm (5 1/4"), Single lumen	\$16.20/ea
JOR1042A	16g X 20cm (8"), Single lumen	\$16.20/ea
JOR1044	4fr X 13cm (5 1/4"), Double lumen	\$28.50/ea
JOR1044A	7fr X 20cm (8"), Double lumen	\$24.00/ea
JOR1044B	7fr X 30cm (12"), Double lumen	\$24.00/ea
JOR1045	5.5fr X 13cm (5 1/4"), Triple lumen	\$31.00/ea
JOR1045A	7fr X 20cm (8"), Triple lumen	\$29.00/ea
JOR1045B	7fr X 30cm (12"), Triple lumen	\$29.00/ea



Jorvet Infusible Pressure Infusor

Pressure infuser for collapsible IV bags. IV bag fits inside mesh and nylon bag. A rubber hand pump attached to a 3-way stop cock allows bag to be filled with air, which exerts pressure on the IV fluid bag.

JOR320P 1 Liter \$50.00/ea

JorVet

BUY NOW



Jorvet Transfusion and Infusion Set

Blood Transfusion and Infusion Set with filter and plastic drip chamber. Roller clamp is flowregulating. Sterile. Disposable. 20 drops/ml.

JOR65 20 drops/ml. \$3.00/ea

JorVet

BUY NOW

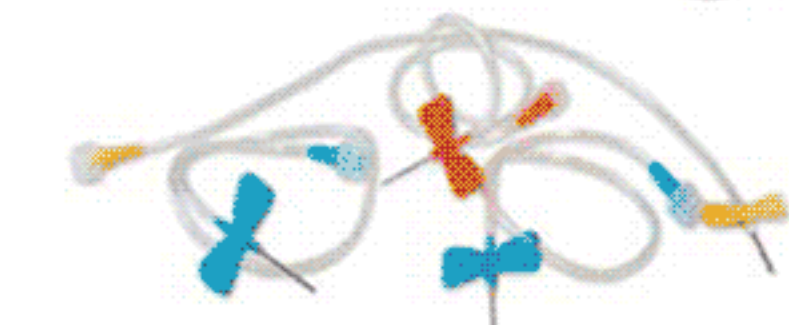
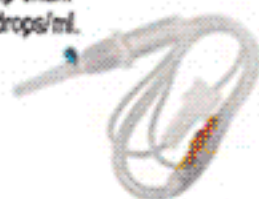

Jorvet Winged IV Infusion Set

BUY NOW

These popular sets are commonly known as Butterfly® style IV sets. They are great for short term IV infusion or in difficult venipunctures. Tubing with female luer fitting is 12" long. A 3/4" razor sharp needle is attached to flexible colored coded wings. Priced very inexpensive.

JOR454A	19g. Yellow, Sterile. 100/box.	\$23.40/box
JOR454B	21g. Green, Sterile. 100/box.	\$23.40/box
JOR454C	23g. Blue, Sterile. 100/box.	\$23.40/box
JOR454D	25g. Orange, Sterile. 100/box.	\$23.40/box

Jorvet Complete Infusion Set

Complete Infusion Set that can handle the large volume of fluid therapy necessary in large animals. The Willoughby style tubing stretches to 10', allowing movement to a restrained or stalled animal. It has a collapsible container made for easy storage in a mobile unit. Non-sterile.

BUY NOW

JorVet

JOR64S	5 liter	\$47.50/ea
JOR64SL	20 liter	\$39.20/ea

Jorvet Collapsible Plastic Bag for Infusion Set

JOR64B	5-liter bag only, Non-sterile	\$20.40/ea
JOR64BL	IV bag with adaptor, 20 liter	\$23.70/ea

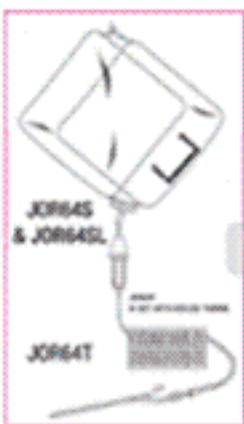

Jorvet Transfer Bag

Designed to receive blood components or plasma, transfer bags have 2 spike entry ports and a single transfer spike with tubing. Sterile. Do not contain anticoagulants.

JOR520TA	150 ml	\$7.65/ea
JOR520TB	300ml	\$9.15/ea
JOR520TC	600ml	\$9.00/ea
JOR520TD	1 liter	\$10.50/ea

BUY NOW

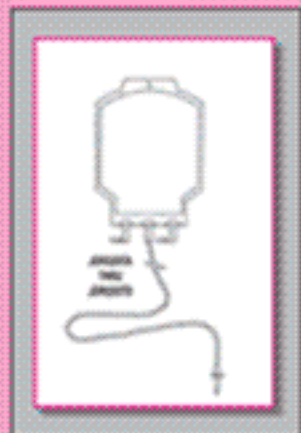

Blood Collection, Lactated Ringers & IV Splints

Jorvet Small Animal Blood Collection Set **BUY NOW**

The addition of these blood collection sets allows for easier and proper feline and small animal blood collection. They are a complete closed system that will get better blood component results, i.e., packed RBC or plasma. The bags are provided dry and anticoagulant (JORS22) will need to be added. The sets come in two basic formats: a set with 19g butterfly needle or a 60cc syringe with a 3-way stop cock. Small blood bag collection set.

- 100 dry (blood) collection bag
- 19g butterfly needle with tubing
- complete directions

JORS20AB	19g butterfly needle with tubing	\$6.90/set
JORS20AX	60cc syringe with a 3-way stop cock	\$10.05/set



Jorvet Single Collection Unit Prefilled CPDA-1 w/anticoag. & needle **BUY NOW**

CPDA-1 is the anticoagulant of choice in human blood banking. After collection, stored blood will have a 35-day shelf life. Bag comes with 16g diamond point non-detachable needle plus double spike ports.

JORS20	450ml.	\$6.15/ea
--------	--------	-----------

JorVet

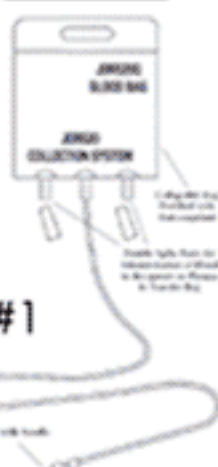

Jorvet Blood Bag 250 w/ CPDA #1

Single Collection Unit Prefilled CPDA-1, 250ml.

JORS20Q	\$5.69/ea
---------	-----------

JorVet

Jorvet Cochran IV Splint **BUY NOW**

Small animal veterinarians often are confronted with the problem of administering a continuous or uninterrupted IV drip to an unattended patient. The cephalic vein is easily occluded when an animal is in a sternal position with the elbow in flexion. The patented Cochran IV Splint is the first product that allows the animal to lie comfortably and still ensure a continuous IV flow. This IV splint will enable the practitioner to extend the patency and longevity of an IV catheter and administer a more continuous and even flow of IV fluids to critically ill patients.

JOR267A	small	\$33.00/ea
JOR267B	medium	\$40.50/ea
JOR267C	large	\$45.00/ea
JOR267D	x-large	\$48.00/ea
JOR267S	Complete set of 4 splints	\$150.00/ea

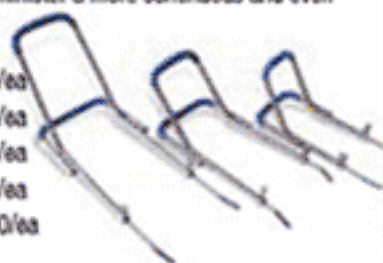

Jorvet Blood Bag **BUY NOW**

Provide your own anticoagulant for the use of these blood bags. Two spike ports with donor tubing with "Y" injection port. Includes directions for use.

JORS20A	Dry, 50 - 150ml	\$5.33/ea
JORS20B	Dry, 300ml	\$7.95/ea
JORS20C	Dry, 600ml	\$7.95/ea
JORS20D	Dry, 1 liter	\$8.40/ea
JORS20F	Dry, 4 liter	\$22.20/ea

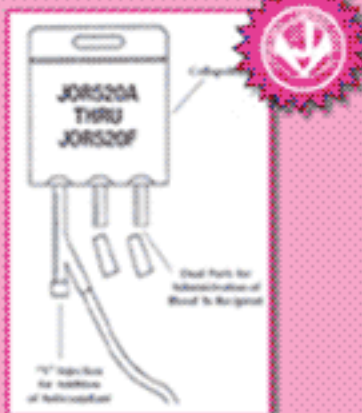

Normosol-R IV Fluids **BUY NOW**

RXNORMOSOL-R	1000ml	\$3.86/ea
--------------	--------	-----------

Lactated Ringers IV Solution **NEW**

RXRINGL-250	250ml	\$1.60/ea
RXRINGL-500	500ml	\$1.79/ea
RXRINGL-1000	1000ml	\$1.99/ea

with 5% Dextrose IV Solution **BL BUY NOW**

RXRINGL-250	250ml	\$1.60/ea
RXRINGL-500	500ml	\$1.79/ea
RXRINGL-1000	1000ml	\$1.99/ea

0.9% Sodium Chloride Injection

RX0.9NAACL-100	100ml bag, 4 bags/pack	\$6.62/pk
RX0.9NAACL-250ML	250ml bag	\$1.68/ea
RX0.9NAACL-500ML	500ml bag	\$1.79/ea
RX0.9NAACL-K	1000ml bag	\$1.99/ea



Jorvet Blood Collection with Attached Transfer Bag

Considered a closed system, this is useful for separating blood components. Collect blood from a suitable donor in the 450ml bag containing the CPDA#1 anticoagulant via standard blood collection techniques. The blood is separated into plasma and red blood cells portions refrigerated upright either via standing gravity or blood centrifuge. Store the bag with the transfer tube on the bottom since concentrated RBCs are heavier. After separation gently snap the white plastic stopper into half to open the transfer channel which allows concentrated RBC to drain into the attached transfer bag. After completion of transfer the connecting tubing is cut and sealed. Benefits include the ability to freeze the plasma portion for an extended period. Concentrated RBC's can be given to an anemic patient in a much smaller volume.

JORS20X	Blood Collection with Attached Transfer Bag	\$9.45/ea
---------	---	-----------

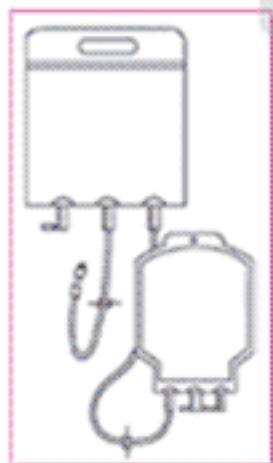

Jorvet Hespan Bag **BUY NOW**

Hespan (Hetastarch), 500ml. A sterile solution of 6 percent hetastarch in 0.9 percent saline. Hetastarch is colloid solution that acts as a plasma expander in cases of hypovolemic shock.

JOR845	500ml bag	\$28.50/bg
--------	-----------	------------

JorVet



Intravenous Products

Jorvet Extension Sets

Jorvet Extension Set 30" w/Male Spin Luerlock

JOR467P \$2.01/ea

Jorvet

BUY NOW

Jorvet IV Extension w/ Needleless Valve & Luerslip

Female luer slip needleless valve and opposite end male luer slip. Sterile. 6".

JOR467Y \$3.15/ea

Jorvet IV Extension Set 30" Male Luer Lip

30" with male luer female luer lock. 30" standard bore tubing. Sterile.

JOR467B 30" with male luer female luer lock. \$1.29/ea

BUY NOW

Jorvet Micro Bore "T" Extension w/ Luerlock

Same configuration as JOR467e, only with smaller micro-bore tubing. Sterile.

JOR467R \$2.30/ea

BUY NOW

Jorvet Standard Bore "T" Extension w/ Luerlock

The distal end is a female luer slip, the proximal end is a male luer spin-lock. The standard bore tubing is equipped with a slide clamp. Injection port is latex-free. Priming volume is 0.69ml. 5"L. Sterile.

JOR467S \$2.40/ea

Jorvet

Jorvet Standard Bore "T"-Port Extension

Ultrasite female luer lock needle free. Spin male luer lock. Latex injection port. 7.5" length (19.1cm). 1.3ml priming volume. Slide clamp.

JOR467F 7.5" length (19.1cm). 1.3ml priming volume

BUY NOW

Jorvet IV Extension w/Needleless Valve & T-Port

The open end is a needleless valve female luer slip. The opposite end is right angle male spin luer lock fitting that also has a latex injection port. Sterile. 13g x 7".

JOR467Z \$3.30/ea

Jorvet

BUY NOW

Jorvet Standard "T" Extension Set

Distal end has a female luer fitting. Proximal end has male luer slip with latex injection port. Also slide clamp for flow control.

JOR467T Sterile. 5"L.

\$2.18/ea

BUY NOW

Jorvet Micro Bore "T" Extension

Same configuration as JOR467T only with smaller bore tubing that is more suitable for smaller patients. Sterile.

JOR467D \$2.40/ea

Jorvet

Jorvet Small Bore Extension Set w/Ultrasite

Ultrasite luer lock needle free valve. Male luer lock. 8" length (20.3cm). 0.61 ml priming volume. Slide closure clamp.

JOR467O \$2.05/ea

BUY NOW

Jorvet Small Bore "T"-Port **Jorvet**

Ultrasite female luerlock needle free. Spin male luer lock. Latex free injection port. Slide clamp.

JOR467E 5.5" length (14cm). 0.66ml priming volume \$4.20/ea

BUY NOW

JOR467P

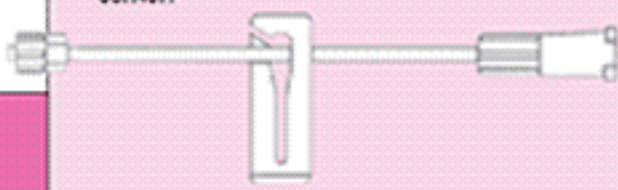

JOR467Y



JOR467B

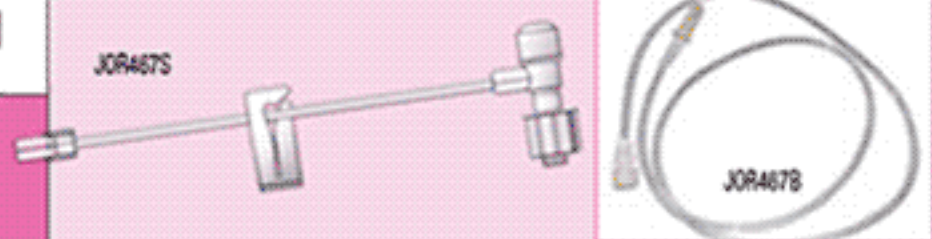

JOR467S



JOR467F

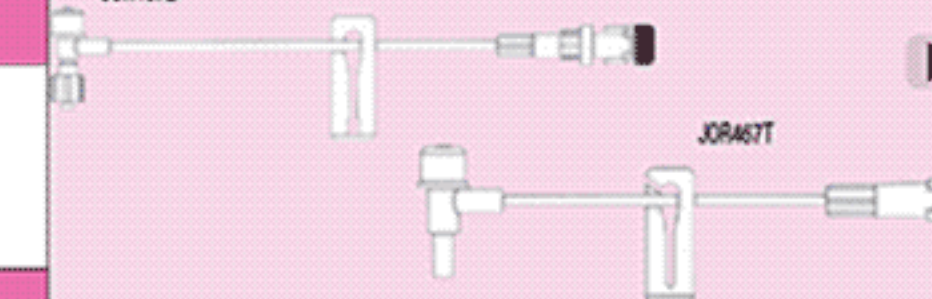

JOR467Z

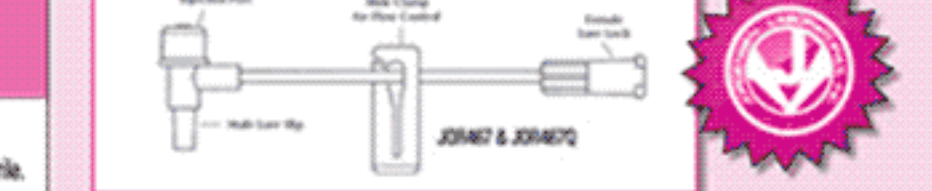

JOR467T



JOR467D



Jorvet

Intravenous Products

Springfusor, Luer Lock Connectors & Adapters

Jorvet Spring Infusor

JorVet

A simple reusable spring-driver pump used for continuous IV infusions over time, requires no batteries or electricity. The pump is matched with various special sized tubing to determine actual flow rate. Uses include administering oncology and anesthetic drugs, and IV fluids to very small patients.

Features:

- Large variety of flow rates available (e.g., 10ml, 5 minutes to 8 hours)
- Compact and very portable
- Reusable
- No programming required
- Not gravity dependent

BUY NOW

JOR831A	Tubing, 10ml/15minutes, 10pk	\$50.50/ea
JOR831B	Tubing, 10ml/30 minutes, 10pk	\$66.00/ea
JOR831C	Tubing, 10ml/60 minutes, 10pk	\$66.00/ea
JOR831D	Tubing, 10ml/2 hour, 10pk	\$66.00/ea
JOR831E	Tubing, 10ml/4 hour, 10pk	\$72.00/ea
JOR831F	Tubing, 10ml/8 hour, 10pk	\$101.00/ea



Jorvet Dual Pinch Tubing Clamp

Slides over tubing for flow control. Accepts up to 6.6mm (20fr) tubing.

JOR594 \$3.60/pk **JorVet**

BUY NOW

Jorvet Mini-Spike

Great for preparing and dispensing diluent from multi-dose rubber-stopped vials (i.e., Naxcel). Utilizes a bacterial retentive air-venting filter. Female luer lock attachment.

JOR591 Sterile, 5/pk. \$10.50/pk

BUY NOW



Jorvet Large Bore IV Administration Set

Larger animals such as horses and cattle require tremendous amounts of IV fluids in a short period of time. The standard smaller human IV sets cannot meet the large IV fluid demands of a critically ill 1,200lb horse. The JorVet Large Bore IV Set can increase the flow rate up to almost 20-liters per hour, a necessary volume in severe colic or equine critical care emergency.

JOR400L	Complete Set, Sterile	\$36.00/ea
JOR400E	Large Bore Extension Set	\$3.00/ea
JOR400T	Large Bore, Transfer Set	\$2.94/ea

BUY NOW



Jorvet Double Christmas Tree Connector

JOR28202 Connects tubing from 4mm to 12mm I.D. 2/pk \$3.15/ea

BUY NOW



Jorvet Barbed Connector with Female Luer Lock

Allows connecting of syringe to catheter

JOR28201 Allows connecting of syringe to catheter \$3.30/ea

BUY NOW



Jorvet Male Luer Adaptor

Sterile latex injection port with protective cap. Often used to cap catheter

JOR463 Male Sterile \$1.05/ea

BUY NOW



Jorvet Male Luerlock Adapter

Latex injection port. Sterile. 1 1/3"L.

JOR463L \$1.05/ea

BUY NOW



Jorvet Dual Male Adaptor

This connector has a male luer lock adaptor on each end. It allows the connection of two female luer fittings. Sterile. 5/pk.

JOR463D 5 pack \$5.40/pk

BUY NOW



Injection Adapter

Medline Injection Site: A conventional intermittent injection site; hep lock and prm adapter. Injection Site, Heplock, Pm Adapter.

DYND75030 Hep Lock and PPN Adapter, 200/cs \$136.91/cs

BUY NOW



Jorvet Safesite Injection Port

Safesite needle-free injection port w/ cap

JOR463N \$0.93/ea

BUY NOW



Jorvet Ultrasite IV Adapter

Allows needle free "syringing" from rubber multi-dose vial bottles without the risk of contamination.

JOR463Q \$2.10/ea

BUY NOW



Jorvet Needle Free Multi Dose Vial Adaptor

Allows needle free "syringing" from rubber multi-dose vial bottles without the risk of contamination.

JOR463X \$3.60/ea

JorVet



Intravenous Products

IV Bag Holder, IV Pump & IV Holder Track System

Jorvet Cage IV Bag Holder

- The simple design allows easy and quick location change.
- Spring-loaded lock holds and clamps securely onto horizontal cage bar.
- Stainless steel 3/8" solid rod looks attractive and professional.
- Fits any standard size cage door from all manufacturers
- Economical, costs considerably less than other holders
- Cleans and disinfects easily after use



JOR461 4"W x 18"H, 0.65 lbs. \$48.00/ea

BUY NOW

Jorvet

Jorvet Space-Saver IV Cage Mount

SpaceSaver Cage Mount will save space and permanently mount on all styles of cages with the ease of dismounting for more flexibility. You can permanently mount and safely secure infusion pumps and IV bags.

JOR461A IV hanger included. \$175.00/ea

BUY NOW

Jorvet



Jorvet IV Latex Surgical Tubing

High quality stretch tubing for a variety of clinical needs. Can be autoclaved. 50'L.

JOR63D1	50 ft reel, 3/16" ID	\$39.00/ea
JOR63D1A	50 ft reel 1/8" x 1/32 ID x 3/16 OD	\$32.10/ea
JOR63D1B	50 ft reel 1/4" ID x 7/16	\$51.00/ea



Jorvet IV Pump

Jorvet

for rapid infusion of large volumes of IV fluids, the rubber bulb pump infuses air into any bottle by needle insertion. Air pressure forces fluid out much quicker than simple gravity.

BUY NOW

JOR27R For equine and bovine use. Dark orange. For equine and bovine use. Dark orange. \$13.20/ea



Jorvet IV Set

Simplex IV Bell. High quality latex. 4' tubing. (needle included)

JOR63 Funnel Type \$9.45/ea



BUY NOW



Jorvet Complete IV Holder Track System

This simple system puts a moveable IV bag holder on a track that is suspended from the ceiling. The IV holder can be positioned above cages, treatment area, or the surgery table. When not in use, it is simply retracted upward and pushed off to the side.

- Track can be installed into any type of ceiling.
- Lightweight aluminum track comes in any length sections; can be trimmed with hacksaw if needed.
- Four-wheel carrier runs in track. It is locked into position by turning it 360°. A pendant ring is attached to carrier.
- IV holder attached to carrier. It has 4 ram's horns at 90° angle. They each can hold an IV bag. It extends and retracts at the push of a button.
- Oval sections of track are also available. IV holder for four bags (JOR833h)
- Four-wheel carrier with ring (JOR833c)
- Two end caps for track (JOR833e)

BUY NOW

Complete IV Holder Track System

JOR833 (track not included) \$270.00/ea

Stationary IV Ceiling Hook

JOR833P (Hardware not included) Suggest attaching JOR833h, IV holder. \$99.00/ea

Splice Plate for IV Track

JOR833S Use to join sections of track over 8' in length. \$5.10/ea

Foot Track Sections (IV Track System)

JOR833T Order track by number of feet desired. 8' maximum for a single piece; splicing needed for longer lengths. \$12.00/ea

IV holder w/ 4 Ring Holder

JOR833H \$214.00/ea

4-wheel Locking Carrier

JOR833C \$62.50/ea

End Cap for IV Track

JOR833E \$5.10/ea



Jorvet

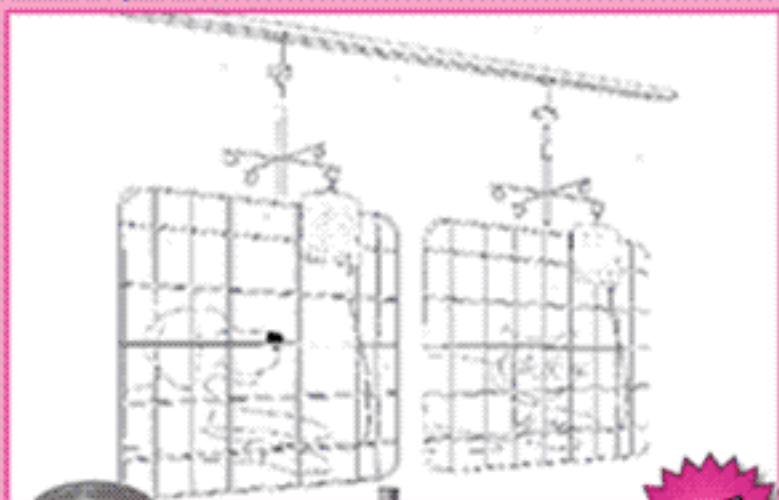

NEW



13822 WEST BOULTON BLVD. METTAWA, IL 60045

WWW.SHOPMEDVET.COM

Phone 800-544-7521

208

Fax 800-204-2177

Intravenous Products

IV Fluid Warmer & Large Volume Sets

Jorvet IV Fluid Warmer

JorVet

Intravenous fluids should be administered as close to body temperature as possible, especially when hypothermia or shock is a concern. The Thermal I.V. is a small, light-weight warming unit that is easily placed over a standard I.V. Line to warm the fluids to 100°F. The unit is placed within 18" of the patient. Thermal I.V. features include:

- A flow rate up to 12 ml/minute
- AC- just plug in and turn on
- Electrical current stepped down to 12 volt for safety
- Adjustable hanging strap
- No separate cartridges needed
- One (1) year manufacturer warranty, Made in the USA



JOR900 Warmer unit \$480.00/ea

Bull Pen Thermal IV Warming Station

Administering IV fluids close to body temperature has become increasingly viewed as a valuable therapeutic modality. Veterinary patients, either small in size or in possible hypovolemic shock, benefit greatly from receiving warm IV fluids (~100°F) versus room temperature (70°F) fluids. However, maintaining a ready supply of warmed fluids has been difficult. The JorVet Bullpen is an IV fluid warming station that maintains unopened IV fluid bags at a ready to use temperature of 100°F. Up to 4 one-liter bags of IV fluids can be warmed and kept ready to use. IV fluids placed on the Bullpen's top can be left for an extended period of time (weeks), warm and ready for the next patient. Simple to use, with no maintenance required, the Bullpen can be left on 24/7. The Bullpen works in conjunction with the JorVet Thermal IV (J-900). A one-liter bag takes 2 1/2 hours to reach 90°F and 6 hours to reach and maintain 100°F.

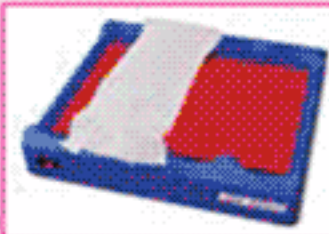

JOR900B One-year warranty, 110V 60 Hz, 16"W x 3 1/8"H x 13 7/8"D, 5.3 lbs. \$412.00/ea

Jorvet Intrafix Air IV Set with "Y" Injection Site.

JorVet

- Same drip chamber features as JOR400
- 78" soft elastic tubing
- "Y" latex injection site 6" from distal end
- Sterile

JOR400Y \$1.44/ea



JorVet Universal Disposable IV Set

- A new IV set from JorVet for use on either vented or non vented IV fluid containers.
- Inexpensive for best value in IV sets
- Sterile

JorVet

JOR400 Sterile \$1.49/ea

Jorvet IV Set Extra Length

JorVet

These sets eliminate the need for extension sets. There are 2 "Y" sites: one near the drip set and the other 8" from the distal end. Plus, there is a latex injection port at the distal end. 100" (250cm). Sterile.

JOR400A 100" (250cm). Sterile. \$1.44/ea

BUY NOW

Jorvet IV Set Mini-Drip Xtra Length

JOR468MA 100" (250cm). Sterile. \$1.35/ea

BUY NOW

Jorvet Mini Basic I.V. Set

60 drop/ml. The standard IV set except has 60 drops/ml drop orifice. This is the preferred set for fine control of fluid administration to really small patients. Sterile. 68" L.

JOR468M 60 dr./ml. \$1.49/ea

BUY NOW

Jorvet I.V. Burette Set

This IV is for small precise volumes that can be accurately measured out in calibrated burette versus 1,000ml IV fluid bags. Very useful for very small patients for accurate dosing.

JOR468B \$3.27/ea

JorVet



Jorvet Large Bore Fluid Transfer Set

Suggested for equine IV use. Large bore makes for faster administration of solutions. Short tubing is ideal for a standing horse. Sterile.

JOR466 30" L. \$5.70/ea

BUY NOW

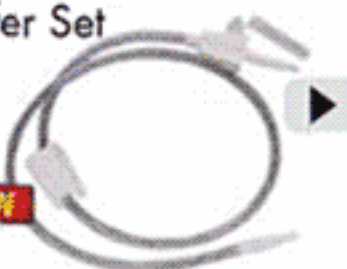

Jorvet Large Bore IV Set

The JorVet large-bore IV set is a simple design for the rapid administration of solutions to large animals. Twice the diameter of conventional IV sets, the large bore increases the flow rate by a factor of 16 over standard human IV sets. Sterile.

JOR400X 72" tubing. \$7.50/ea

JorVet

BUY NOW



Jorvet Large Volume IV Solution Bag

New collapsible bag with large-size drip chamber for use with concentrates of lactated ringers. For rapid infusion of large volumes.

JOR400P 3 liter \$26.10/ea

JOR4000 6 liter \$22.50/ea

JorVet

BUY NOW



Stainless Steel Buckets and Feed Bowls

Stainless Steel Kick Bucket

Heavy-duty stainless steel frame. Rubber ball bearing 2" casters. 360 degree bumper on frame. 14 1/2" D x 12" H with bucket.

BUY NOW

JOR808	Bucket and frame Kit	\$156.00/ea
JOR808F	Frame Only	\$122.00/ea

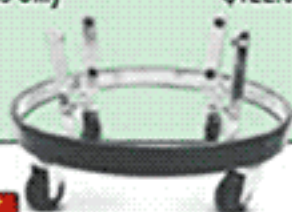

Stainless Steel Pails With Handle

Stainless Steel is corrosion resistant. Pails are heavy-duty for everyday use. Cleans and disinfects easily. They will keep their bright shine new look, and are dishwasher safe.

BUY NOW

JOR805A	64oz (2 quart)	\$13.20/ea
JOR805B	128oz (4 quart)	\$19.20/ea
JOR805C	192oz (6 quart)	\$25.50/ea
JOR805D	288oz (9 quart)	\$33.00/ea
JOR805E	416oz (13 Quart)	\$43.50/ea



BUY NOW

Regular Stainless Steel Bowls (A)

Stainless Steel is corrosion resistant, and almost chew-proof. They are heavy-duty for everyday use. Cleans and disinfects easily. They will keep their bright shine and new look, and they are dishwasher safe. Standard shape, no sharp edges. 9-gauge thickness, 6-gauge on larger bowls.

JOR802A	8oz (1/2 pint)	\$2.30/ea
JOR802B	16oz (1 pint)	\$2.85/ea
JOR802C	32oz (1 quart)	\$4.25/ea
JOR802D	64oz (2 quart)	\$4.80/ea
JOR802E	72oz (2.5 quart)	\$5.60/ea
JOR802F	96oz (3 quart)	\$7.35/ea
JOR802G	160oz (5 quart)	\$8.45/ea
JOR802H	240oz (7 1/2 quart)	\$15.20/ea
JOR802J	320oz (10 quart)	\$21.20/ea

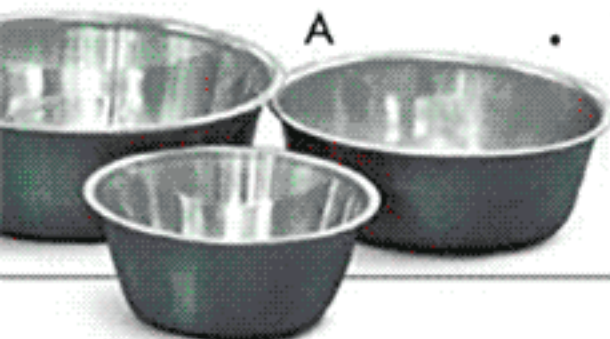

BUY NOW

Heavy Duty Stainless Steel Bowls (B)

Stainless Steel is corrosion resistant, and almost chew-proof. They are heavy-duty for everyday use. Cleans and disinfects easily. They will keep their bright shine and new look, and they are dishwasher safe. Standard shape, no sharp edges. Gauge is 50-100% thicker than the regular bowls.

JOR803A	16oz (1 pint)	\$5.05/ea
JOR803B	32oz (1 quart)	\$6.45/ea
JOR803C	64oz (2 quart)	\$9.75/ea
JOR803D	96oz (3 quart)	\$13.50/ea
JOR803E	128oz (4 quart)	\$16.05/ea



BUY NOW

Non-Tip Stainless Steel Bowls (C)

This heavy-duty bowl features a wide diameter and protective rubber cushion, making it more difficult for animals to tip or knock over the bowl. Less chance for messy water and food spills.

JOR804A	8oz (1/2 pint)	\$4.05/ea
JOR804B	16oz (1 pint)	\$5.55/ea
JOR804C	32oz (1 quart)	\$8.40/ea
JOR804D	64oz (2 quart)	\$9.45/ea



Straight-Sided Pail

12-quart stainless steel with handle. This pail takes up less storage space than conventional pails.

JOR398S	13 quarts	\$69.00/ea
---------	-----------	------------



Double Diners

BUY NOW

Double-Diner lift out bowls nest in vinyl-coated wire holders. Allows dogs to easily eat without having to chase their bowls. Legs have rubber feet to protect floors. Available in fixed or adjustable height models.

CPSF5	1/2 Pint Bowls	\$4.00/ea
CPSF1	1 Pint Bowls	\$4.50/ea
CPSF2	1 Quart Bowls	\$6.00/ea
CPSF3	2 Quart Bowls	\$7.50/ea
CPSF4	3 Quart Bowls	\$9.00/ea
CPSF9	3 Position (2 quart bowls)	\$25.00/ea



JorVet

Equipment & Furnishings

Instrument Trays & Stands

Mayo Tray (A)

Fits Item# JOR807 and JOR807D

49-363 19 1/8" x 12 5/8" x 3/4" \$41.60/ea

Mayo Tray (B)

Top: 13 3/4" x 10" x 2/3". Bottom: 11 3/4" x 7 1/2" x 2/3".

JOR097 14" x 10" x 2/3" \$35.40/ea

Instrument Tray (C)

Stainless Steel Hospital Ware is manufactured to the exacting standards of the healthcare industry. Every product is manufactured using seamless technology, which eliminates areas that can harbor bacteria growth. All utensils are manufactured of 18-8 nickel-bearing stainless steel to prevent rust, and polished to a mirror finish.

49-365 10" x 6 1/2" x 3/4" \$17.90/ea
 49-367 15" x 10 5/8" x 3/4" \$31.90/ea
 49-368 17" x 11 5/8" x 3/4" \$41.16/ea

Instrument Tray, Strap Handle (D)

Instrument Tray with strap handle on lid. Top: 12" x 8 1/4" x 2 1/4". Bottom: 10 1/2" x 6 1/4" x 2".

JOR393A 10" x 6 1/2" x 2" \$44.40/ea
 JOR393B 12" x 7 3/4" x 2 1/4" \$49.50/ea

Stainless Steel Replacement Tray

JOR807T 19" x 12 1/2" x 3/4" Mayo Tray Only \$66.50/ea

Not Pictured

Instrument or Spay Pack Tray (E)

Below trays without lids.

JOR099A Top: 10 1/4" x 6 3/4" x 2". Bottom: 9" x 5 1/2" x 2". \$30.30/ea

JOR099B Top: 12" x 7 3/4" x 1 15/16". Bottom: 10 1/2" x 6 1/4" x 2". \$34.50/ea

Catheter and Instrument Tray with Flat Cover (F)

49-361 12 1/4" x 7 3/4" x 2 1/4" \$38.25/ea

Catheter and Instrument Tray with Dome Cover (G)

49-369 8 3/4" x 3 1/4" x 1 1/2" \$23.04/ea
 49-370 8 7/8" x 5" x 2" \$29.00/ea
 49-372 17.25" x 4.5" x 2" \$47.24/ea

Catheter & Instrument Tray (H)

JOR398 With cover, Top: 3 1/2" W x 12 1/2" L x 1 3/4" H. (92.4cm x 9.3cm x 4.4cm). Bottom: 12" x 3" x 1 3/4". \$28.20/ea

JOR398A With cover and strap handle, 3" W x 8 2/3" L x 1 1/2" H. (22cm x 7cm x 3.8cm). \$27.75/ea

Catheter Tray

JOR398C Top: 16" x 3" x 2 1/2". Bottom: 15 3/4" x 2 3/4" x 2". \$48.00/ea

Double Post Mayo Stand (I)

Heavy rectangle base 21" x 20". Two ball-bearing rubber casters. Removable stainless steel trays. Adjustable height: 34" to 54".

JOR807D 21" x 20", Double Post \$175.00/ea

Mobile Instrument Mayo Stand (J)

Stable 5-leg aluminum base, 24" diameter Dual wheel casters. Removable stainless steel trays. Adjustable height: 31" to 50".

JOR007M 5-Leg, adj from 31" to 50" \$168.00/ea

Single Post Mayo Stand (K)

U-shaped heavy chrome base, 18" x 22". Two ball bearing rubber casters. Removable stainless steel trays. Adjustable height: 31" to 50".

JOR007 18" x 22", Single Post \$169.00/ea

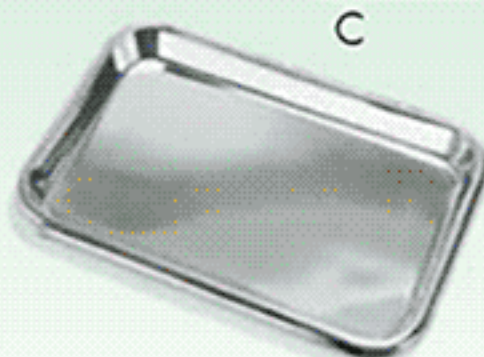

Equipment & Furnishings

Stainless Steel



Tumbler (A) **BUY NOW**

49-344	2 7/8" x 3 1/8" 7oz	\$5.90/ea
49-345	3 3/16" x 4" 12oz	\$7.90/ea

Dressing Jar (B)

49-333	4 1/8" X 2 1/4" With Cover 1/2 Qt.	\$15.58/ea
49-334	4 1/8" X 5 1/2" With Cover 1-1/4 Qt	\$19.13/ea
49-335	4 1/8" X 6 1/4" With Cover 1-7/8 Qt	\$27.63/ea

Solution Bowl (C) **BUY NOW**

49-389	13 5/8" x 4 5/8" 7 qt	\$44.53/ea
--------	-----------------------	------------

Sponge Bowl (D) **BUY NOW**

49-383	4 1/4" x 2" 12oz	\$7.00/ea
49-385	5 9/16" x 2 9/16" 29oz	\$9.90/ea
49-386	6 1/4" x 2 3/4" 36oz	\$13.90/ea
49-387	7 9/16" x 3" 64oz	\$22.50/ea
JOR394	3 1/2" x 1 1/2" deep	\$6.60/ea/ea

Graduated Measures Cup (E) **BUY NOW**

49-355	3 3/4" x 4 5/8" 16oz	\$24.45/ea
49-356	4 3/4" x 4 1/4" 32oz	\$33.65/ea

Iodine Cup (F) **BUY NOW**

49-341	3 7/16" x 2" 6 oz	\$3.95/ea
49-342	4 3/8" x 2 5/8" 14oz	\$8.15/ea

Ointment Jar With Handles (G)

49-348	3 1/8" x 2 3/4" 9oz	\$17.00/ea
--------	---------------------	------------

Emesis Basin (H) **BUY NOW**

49-380	9 7/8" x 4 1/2" x 2 1/4" 26oz	\$14.52/ea
49-381	6 5/8" x 3 1/2" x 1 1/2" 10oz	\$7.90/ea
49-382	8 1/8" x 3 5/8" x 1 5/8" 12oz	\$11.33/ea

Forceps Jar (I) **BUY NOW**

49-351	2 1/4" X 7"	\$22.30/ea
JOR396	6 1/2" x 2 1/4"	\$23.40/ea

Thermometer Jar (J)

49-346	1" x 4"	\$13.50/ea
--------	---------	------------

Thermometer Jar (K)
Stores glass thermometers. Wide base to give greater stability and avoid tipping over.

JOR396A	3 1/4" H (3.4cm x 9cm) x 1 1/2" dia.	\$10.20/ea
---------	--------------------------------------	------------

BUY NOW

Dressing Jar (L) **BUY NOW**
1-liter capacity. 5"H (10cm x 12.7cm) x 4" dia.

JOR395A	(4" d) x (5" h)	\$23.40/ea
JOR395B	(5" d) x (6 1/4" h)	\$28.20/ea

Medicine Cup (M) **BUY NOW**

49-343	2 1/8" x 2" 2oz	\$4.20/ea
--------	-----------------	-----------

Shop 24 hours a day 7 Days a week
WWW.SHOPMEDVET.COM

Equipment & Furnishings

Lighting, Stretchers, Warm Water Pump & Vital Signs Monitor

Animal Stretcher **BUY NOW**

Features a mesh "envelope" that completely covers any size animal up to 200 lbs. giving complete control over the animal while calming it yet allowing it to breathe. The envelope stabilizes fractures and prevents animal escape. The trolley with large 6" wheels, have both been tested to over 250 lbs. weight. The wheel kit allows for easy rolling over even rough surfaces.

YDC-9 22" x 45", 250lbs capacity \$79.00/ea



Jorvet Soft Carry Stretcher **BUY NOW**

Great for injured animal transport. Absence of rigid poles allows carrying of patients in tight corners. Large size for carrying all types of patients. Six padded handles for carrying comfort. Washable nylon.

JOR742B 21" x 34" \$27.00/ea



Burton Outpatient II **BUY NOW**

Has all the features of the Outpatient Plus and more. Enhanced illumination plus it's focusable, 7000 foot candles at 24" (40% brighter) Focuses with central removable autoclavable SteriHandle™ Uses three 50-watt halogen bulbs, each with 2000 hour life. Comes with single ceiling mount.

Light shipped directly from manufacturer. Shipping charges billed at actual freight.

224122 Ceiling Mount \$2,495.00/ea



Fleximount Wall Mount Kit **BUY NOW**

Easy to install. Saves space. Allows 45" arm extension. Light mount shipped directly from manufacturer. Shipping charges billed at actual freight. Mount only. Lights are not included.

100160 Mount only \$600.00/ea



Burton AIM-50 Floor Lamp **BUY NOW**

Technical Specifications:

- Illumination: 99,000 Lux at 24", 45,000 Lux at 36 inches.
- Color temperature: 3100° K.
- Compact 20-inch/51cm diameter lighthead.
- Larger and adjustable light pattern.
- Uses three 50-watt halogen bulbs with 2000-hour bulb life.
- Extremely smooth focus mechanism with autoclavable handle in the center.
- Y-shaped lighthead promotes light pattern free of cast shadows.
- On/Off standby switch on the lighthead.

AS0FL Each \$3,160.00/ea

Light, single Ceiling Mount Kit **BUY NOW**

100540 \$650.00/ea

Burton Outpatient II Dual Ceiling Light **BUY NOW**

OP216DC \$4,600.00/ea

Gleamer Floor Stand Light **BUY NOW**

All-purpose, rugged, compact halogen light. Offering 4166 footcandles, a sturdy gooseneck and superior quality components. Provides high intensity, maximum flexibility and extraordinary reliability. It's unique venting system, energy absorbing infrared exchanger and patented reflector filter coatings provide a heat-free beam in a cool, yet compact housing.

960112 Floorstand with casters \$788.00/ea

Halogen Light **BUY NOW**

You'll be able to work closely with this cool, intense light source to perform suturing, biopsies or any procedure where you need extra light. 20-watt halogen bulb with 1200 hour life provides a 5"-9" pre-focused spot. 30000K color temperature. Weighted base with 4 locking casters and 24" heavy duty gooseneck for easy positioning. 3-year warranty. Light shipped directly from manufacturer. Shipping charges billed at actual freight.

152113 4 Caster Base \$893.00/ea

Circulating Warm Water Pump **BUY NOW**

Hypothermia is a constant risk for the small veterinary surgical patient. Approximately 60-70% of surgery patients become hypothermic. Recent human medical studies have proven that keeping patients warm during and after surgery can markedly improve clinical outcomes. This system places a flat comfortable vinyl blanket under the patient. Warm water is circulated throughout this blanket by a special electrical pump. This pump maintains your selection of temps (88°-107°) within 1.5°F. The pump is matched with the blanket size and material of your choice. This pump has a number of important features:

- Audible Alarm: low water, tilt
- 1 year warranty open sensor and high temperature
- Self-sealing connectors for no water leakage
- Dual thermostats for safety * Includes 8 feet of connecting hose
- 10" (H) X 7" (Diameter) weighs 6lbs *Micro Processor Control
- 50 oz. Water reservoir *Digital LED Readout
- Can use tap water *Flow rate 15 gallons/hour
- 8 ft electrical cord *UL approved

JOR783X \$545.00/ea



Vital Signs Monitor **BUY NOW**

Vital Signs Monitor 300 Series is ideal for Spot Checks or Continuous Monitoring. This full-featured monitor measures blood pressure (NIBP), pulse rate, MAP and SpO2, plus includes SureTemp® Plus thermometry for oral temperature readings in just 4 seconds. Nellcor® pulse oximetry, SureTemp® Thermometry and an integrated thermal printer are optional. Includes auto blood pressure mode, programmable alarms and built-in memory. R-232 computer interface allows you to upload data to your network or PC. Vital Signs Monitor complete with NIBP, Nellcor SpO2, SureTemp® Thermometry and Printer.

W-AS3NTP1 measures blood pressure (NIBP), pulse rate, MAP and SpO2, plus includes SureTemp® Plus thermometry for oral temperature readings in just 4 seconds \$5,900.00/ea



Electrosurgical Units and Electrodes

Jorvet Electrosurgical Unit

The most affordable unit available for today's veterinary surgeon. With more than enough power for any procedure.

Features:

- 3 operating modes at the turn of a dial
- Fully filtered: smooth cutting
- Fully rectified: cutting & coagulation
- Partially rectified: Coagulation: larger bleeders
- 10 different power settings
- Wide selection of electrodes included
- Includes ground plate

BUY NOW

JOR470	3 modes	\$810.00/ea
JOR470A	220 volt	\$810.00/ea

Bipolar converter

BUY NOW

Bipolar mode of coagulation is especially useful in small species such as birds. It allows for a more precise and controlled coagulation, including in wet field.

JOR470B Plugs into front of JOR470 unit \$138.00/ea to convert to bipolar mode.

Power Cord Only for JOR470

JOR470PC Power cord for JOR470 only \$20.00/ea

Ground plate

JOR470D2 \$39.00/ea



Electrosurgical Unit Electrode **Jorvet**

BUY NOW

Autoclavable. 1/16" Use only with J-470 unit NOTE: DO NOT store in liquids.

JOR470D1	Diamond Loop	\$12.00/ea	JOR470D5	Fine Wire	\$12.00/ea
JOR470D2	Large Loop	\$12.00/ea	JOR470D7	Small Oval Loop	\$12.00/ea
JOR470D3	Small Loop	\$12.00/ea	JOR470D9	Ball Electrode	\$12.00/ea
JOR470D4	Heavy Wire	\$12.00/ea	JOR470D3	Electrode, set of 7	\$69.00/ea/ea

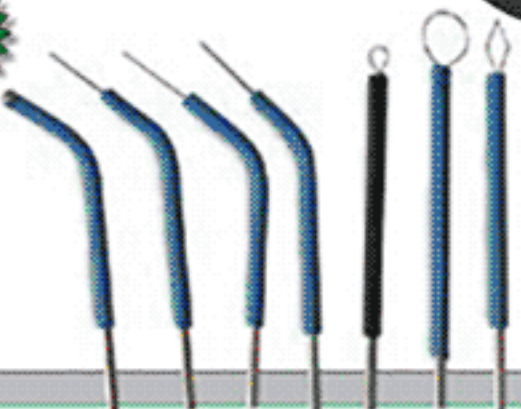

Reusable Electrode **Jorvet**

BUY NOW

Autoclavable. 3/32"

JOR484A1	Angled Fine Needle	\$54.75/ea
JOR484A2	Angled	\$42.75/ea
JOR484A3	Angled Sharp	\$46.50/ea
JOR484A4	Angle, Ball	\$52.50/ea
JOR484A5	Straight Ball	\$51.00/ea
JOR484A6	Straight Needle	\$51.00/ea
JOR484A7	Long Straight Ball	\$49.50/ea
JOR484A8	Long Straight Needle	\$49.50/ea
JOR484A9	Triangle electrode 1/2"	\$26.50/ea



Reusable Loop Electrode

Great for removing skin tumors. 3/32", Loop. 3/8" dia

JOR484AD2	Loop. 3/8" dia	\$42.50/ea
JOR484AD3	Re-usable 1/2", each	\$43.00/ea

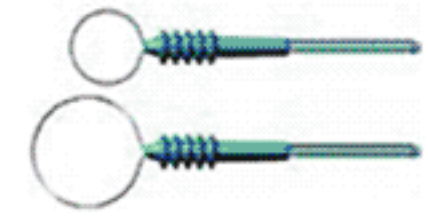

Reusable Bipolar Forceps **Jorvet**

BUY NOW

Autoclavable

JOR484B1	Fine Forceps. 5"	\$260.00/ea
JOR484B2	Medium Forceps. 5 1/2"	\$260.00/ea
JOR484B3	Curved Fine Forceps. 5"	\$260.00/ea
JOR484B4	Curved Fine Forceps. 7"	\$260.00/ea
JOR484B5	Straight Fine Forceps. 7"	\$260.00/ea
JOR484B6	Bayonet Medium Forceps. 7 1/2"	\$260.00/ea
JOR484B7	Bayonet Fine Forceps. 7 1/2"	\$260.00/ea
JOR484BC	Bipolar Cord for JOR484m	\$65.00/ea
JOR484MD9	Foot pedal for bowie 1250	\$502.00/ea

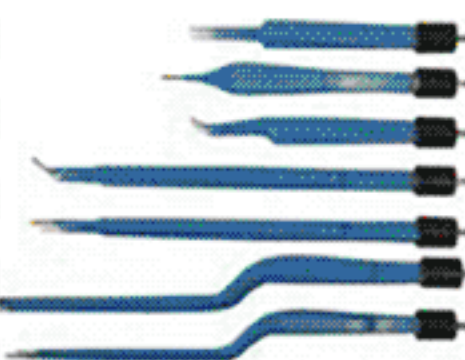

Disposable Electrode

3/32" **Jorvet**

JOR484AD4	Standard Needle. 25/box	\$68.00/ea
JOR484AD5	Standard Blade. 50/box	\$68.00/ea



Bovie 2250 Digital Electro Surge Generator

A more powerful unit is needed when doing specialized endoscopy procedures like OHE's or spays. This unit will work well with Richard Wolf's Powerblade and other brands of bipolar endoscopy equipment. The increased power is the cut format: 200 watts, fulguration: 80 watts, bipolar: 80 watts. Uses the same JOR484 3/32" tips shown on the following page. 12.3"W x 16.3D x 6"H. Accessories included:

- Two disp hand pieces (JOR484md1a)
- Autoclavable hand piece (JOR484md1c)
- Reusable body or ground plate
- Five different electrodes
- Two Electrodes - standard needle (JOR484ad4)*
- x Three Electrodes - standard blade. (JOR484ad5)* Two-year warranty Optional item: JOR484xd1 Bipolar Foot Switch



BUY NOW

JOR484X \$6,290.00/ea

JorVet



Bovie Electrosurgical Unit Stand

JOR484TA Table Top Stand \$86.00/ea

BUY NOW

Deluxe Electrosurgical Ground Plate and Cord

JOR484D3 \$188.00/ea

BUY NOW

Foot Switch

JOR484D2 \$139.00/ea

Autoclavable Handpiece

Bovie 1250 autoclavable handpiece

JOR484MD1C \$54.00/ea

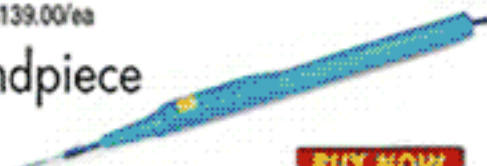

BUY NOW

Nebulizer/Compressor

Aeromist® Plus Nebulizer Compressor: Get a high quality nebulizer without the high cost. This new sleek design is easy to pick up with break resistant hinges. It remains stable when laying flat on four non-skid rubber feet due to its low center of gravity. The compact design easily fits on small surfaces and the cord conveniently stores inside the shell when not in use.

- Electrical Requirements: 115 VAC / 60 Hz
- Power Consumption: 75 W
- Dimensions: 4.1" (105 mm) H x 5.7" (145 mm) W x 7.9" (200 mm) D; Weight: 1.6 kg (3.53 lb.)
- Sound Pressure Level: 53 dBA; Max. Comp.
- Pressure: 30 PSIG or greater
- Neb. Operating Pressure: 10 - 14 PSIG; Liter Flow Range: 4 - 8 LPM; Particle Size Less Than: 5 microns
- Maximum nebulizer solution capacity: 10 ml
- Operating Temperature: 10 C - 40 C (50 F to 104 F)
- Operating Humidity: Up to 95% non-condensing
- Storage/Transport Temperature Range: -20 C - 60 C (-4 F to 140 F);
- Storage/Transport Humidity: Up to 95 % non-condensing.



HCS80004 Compact size with initial circuit \$345.00/ea



Deluxe Bovie Electrosurgical Unit

This is a top-of-the-line Electro surgical unit made by the original Bovie Company. They first invented the Electro surgical unit in the 1920s. The complete table top unit is fitted with veterinary specific equipment. Five modes: cutting, cutting/coagulation, coagulation, fulguration, bipolar. User has option of handpiece finger switch or foot control

- Rotary dial operates power; shown in 1 watt increments via LED readout
- Reusable body pad (ground plate)
- Built-in bipolar (requires optional foot pedal)
- Five 3/32" electrodes; interchangeable with other same size brands
- 101/4"W x 51/2"H x 10"D, 14 lbs.
- U.L. approved Accessories Included:
- Two Disposable Handpieces (JOR484md1a)
- Autoclavable Handpiece (JOR484md1c).



JOR484M NOTE: Bipolar forceps and cord sold separately. \$2,880.00/ea

JOR484MW 220V \$3,600.00/ea

JorVet

BUY NOW



Bipolar Footswitch for JOR484X

JOR484XD1 \$240.00/ea

BUY NOW

Ground Plate Cord for JOR484M

JOR484MD4 \$102.00/ea

Ground Plate Cord Only

JOR484D3C \$110.00/ea

Ground Plate Only

JOR484D3P \$92.00/ea



Triangle Electrode

Reusable, 3/32".

JOR484A11 1/8" \$26.50/ea

JorVet



Diamond Electrode

Diamond Electrode, Reusable, 3/32".

JOR484A13 Diamond electrode 1/4" \$26.50/ea

JOR484A14 Diamond electrode 1/8" \$26.50/ea

JorVet

BUY NOW

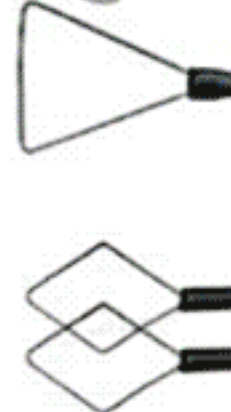

Electrode Loop

Reusable 3/32" for JOR484 & JOR484M units

JOR484AD1 re-usable 1/4", each \$44.75/ea

BUY NOW

JorVet



Equipment & Furnishings

Gas Vak Systems & Accessories

Jorvet Multi-Station GasVak Unit

There is an increasing awareness among veterinarians and their staff about the health hazards of breathing waste anesthetic gases. The Jorvet GasVak Scavenger system is an active unit that removes waste anesthetic gases at the pop-off valve on all anesthetic machines or from the end of a non-rebreathing system. The waste gas is then vented outside the clinic via a vacuum fan power unit.

- For facilities with more than one anesthesia location
- Ceiling outlet or balancing valve at each location
- Each anesthesia machine has a scavenger interface or atmospheric equalizer mounted on gas machine

JOR302 Unit comes complete with: **\$1,242.00/ea**
 • Two balancing valves
 • Two atmospheric equalizers

BUY NOW

Multi-Station GasVak Unit

JOR302W Multi-Station GasVak Unit with Wall Mount Balancing Valves **\$1,272.00/ea**

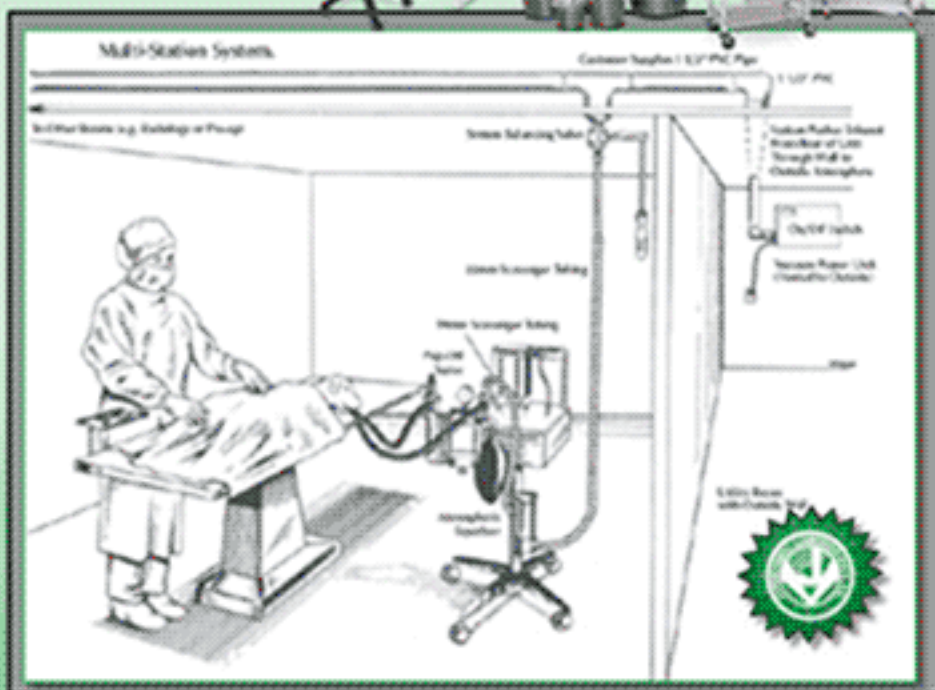

Multi-station Gas-Vaks **BUY NOW**

JOR302PLUS up to 30 stations **\$1,465.00/ea**



Equine GasVak System

JOR302E Equine Model **\$1,126.00/ea**

BUY NOW

GasVak Motor & Housing Only

JOR302MH **\$712.00/ea** 

GasVak™ Active Scavenging System

JOR302R Multi-station with Remote Control. **\$1,700.00/ea**

Jorvet GasVak™ Scavenging System

The Jorvet GasVak Scavenger System is an active unit that removes waste anesthetic gases at the pop-off valve on all anesthetic machines or from the end of a non-rebreathing system. The waste gas is then vented outside the clinic via a vacuum fan power unit.

- Mounted next to outside wall
- Up to 25' of tubing or PVC pipe can be on exhaust, allowing exit through the ceiling or going up and over another room.
- Works best with one anesthesia location and one anesthesia machine.
- Scavenger tubing provided

JOR301 Single Station **\$722.00/ea** **BUY NOW**

Jorvet Gas-Vak Scavenging Tune-up Kit

- Tune-up Kit consists of:
- 22mm corrugated clear tubing, 15'.
- 19mm corrugated blue tubing, 15'.
- Four adaptors, 22mm o.d. x 22mm o.d./15mm i.d.
- Two adaptors (cuffs), 22mm o.d. x 22mm i.d.
- Two adaptors, 19mm i.d./22mm o.d. x 22mm o.d./15mm i.d.



JOR302T **\$69.00/ea** **BUY NOW**

For each anesthesia station the following equipment is required.

GasVak™ Balancing Valve

JOR30202 One per anesthesia station. **\$163.00/ea**

GasVak™ Atmospheric Equalizer

JOR30201 One per anesthesia machine. **\$217.00/ea**

Jorvet Flowmeter

JOR30204 **\$97.00/ea**

JOR30202W

Wall Mount Balancing Valve

JOR30202W For each anesthesia station the following equipment is needed **\$217.00/ea**

BUY NOW

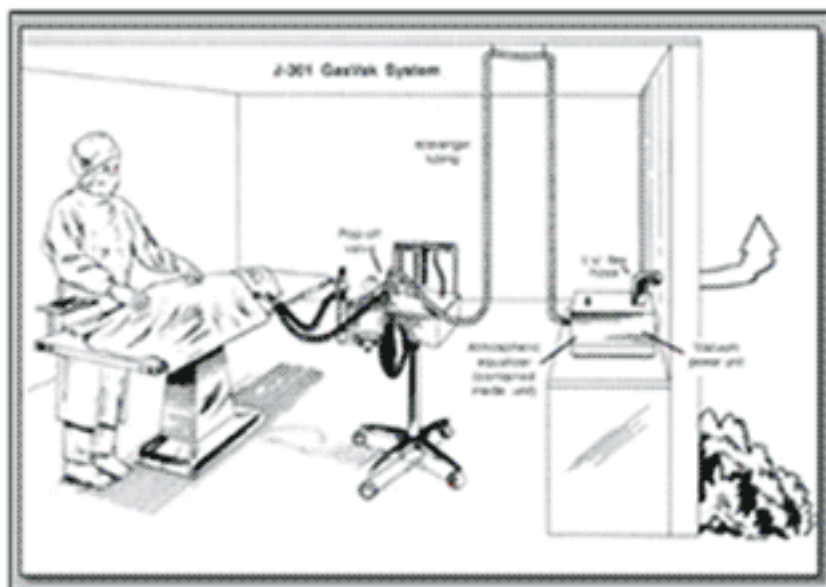

Equipment & Furnishings

Cryosurgery

BUY NOW

Small Animal Cryo Kit **Jorvet**

This kit uses the mini-cryogun for ease of handling. Includes three different apertures: 18mm cryochamber, 1cm flat probe, malleable extension. Mini cryogun 25cm H, 0.3kg. 0.3-liter capacity.

JOR810 \$670.00/ea

Large Animal Cryogun Kit

For use in large animal or mixed practice. Additional probes or attachments can be added as needed. Includes three different apertures: 18mm cryochamber, 1cm flat probe, malleable extension. Standard cryogun 28cm H, 0.5kg. 0.5-liter capacity.

JOR810A \$679.00/ea

Cryosurgery Accessory Items

JOR810Z Ferret Adrenal Gland Probe. Specially designed probe for freezing adrenal gland tumors in ferrets. \$100.00/ea

JOR8110 Ladle For filling cryogun. \$140.00/ea

JOR810J Back Vent Adapter \$28.00/ea

Eliminates intermittent spray and increases nitrogen flow when used with small contact probes and smaller apertures.

Adapt your own needles to this luer lock fitting.

JOR810U Luer Lock Adapter \$28.00/ea

Allows easy transport of cryogun with two pockets for probe storage. velcro closure.

JOR810T \$37.00/ea

An inexpensive, simple, and efficient way to extract liquid nitrogen from Dewar storage to your cryogun. NOTE: Please supply manufacturer, model number, and capacity of Dewar when ordering.

JOR811J Withdrawal Tube \$330.00/ea

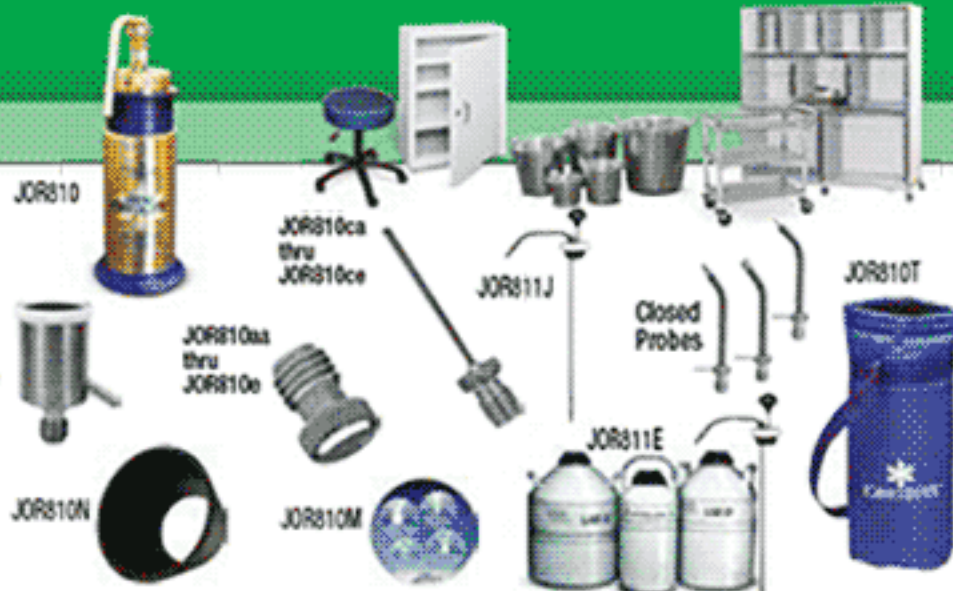

Cryogun® Spray Attachments

A transparent lexan plate with four various size conical openings. Used to concentrate spray within a limited area.

JOR810DF Concave probe 1cm diameter \$74.00/ea

A set of six neoprene cones that are used to concentrate or direct spray within a limited area.

JOR810N Cryocones \$121.00/pk

JOR810M Cryoplate \$50.00/ea

Storage Equipment. New and improved Dewar allows for longer storage of liquid nitrogen—up to 300 days. NOTE: Other sizes of Dewars available.

JOR811C Dewar 10 liter \$755.00/ea

JOR811E Dewar 20 liter \$1,320.00/ea

Allows easy transport of cryogun with two pockets for probe storage. velcro closure.

JOR810T \$37.00/ea

Jorvet Opening Site Aperture.

Straight Spray Attachments. NOTE: Open spray attachments are used for lesions on patient's outside body. The bigger the aperture, the larger the volume of spray dispensed. **Jorvet**

JOR810AA Opening Site Aperture, 0.04" \$21.50/ea

BUY NOW

Jorvet Straight Spray Extension

Used to reach deep recessed areas. **Jorvet**

JOR810CA Straight Spray Extension, 18g x 1 1/2" \$32.00/ea

JOR810CB Straight Spray Extension, 18g x 1 1/2" \$32.00/ea

JOR810CC Straight Spray Extension, 1 1/2" x 20g \$32.00/ea

JOR810CD Straight Spray Extension \$53.00/ea

JOR810CE Bent-Tip Spray Extension, 20g x 3" \$57.00/ea

Jorvet Cryochamber

Permits precise confined spray. Liquid nitrogen pools over deep lesions. Suggested use with malleable extensions (e.g., JOR810ra)

JOR810DB Cryochamber, 10mm \$69.00/ea

JOR810DC Cryochamber, 15mm \$69.00/ea

JOR810DD Cryochamber, 18mm \$69.00/ea

JOR810DA Cryochamber, 6mm \$69.00/ea

Jorvet Conical-Shaped Closed Probe

These probes are inserted into large or ulcerated lesions, thereby markedly increasing the surface area of the freeze. Closed Probe. Only the tip is cooled via a hollow tube down the probe. A side port vents the liquid nitrogen. **Jorvet**

JOR810EA Conical-Shaped Closed Probe, 1mm \$75.00/ea

JOR810EB Conical-Shaped Closed Probe, 2mm \$75.00/ea

JOR810EC Conical-Shaped Closed Probe, 3mm \$75.00/ea

JOR810ED Conical-Shaped Closed Probe, 4mm \$75.00/ea

JOR810EF Conical-Shaped Closed Probe, 5mm \$75.00/ea

JOR810EG Conical-Shaped Closed Probe, 6mm \$75.00/ea

JOR810EH Conical-Shaped Closed Probe, Sharp Pointed Conical Closed Probe \$76.00/ea

Flat Closed Probe

Circular, and useful for wide flat lesions (e.g., squamous cell carcinoma and sarcoids).

JOR810FA Flat Closed Probe, 1.0cm dia. \$75.00/ea

JOR810FB Flat Closed Probe, 2.0cm dia. \$90.00/ea

JOR810FC Flat Closed Probe, 2.5cm dia. \$102.00/ea

JOR810FD Flat Closed Probe, 3.0cm dia. \$120.00/ea

JOR810GL Neurectomy Probe \$150.00/ea

JOR810GLA Neurectomy probe for 16oz. \$150.00/ea

Jorvet Mini Closed Probe

Used to treat eyelid margin and corneal lesions. Gently curved to allow visualization and precise control.

JOR810GA Mini Closed Probe, 1mm \$84.00/ea

JOR810GB Mini Closed Probe, 2mm \$84.00/ea

JOR810GC Mini Closed Probe, 3mm \$84.00/ea

JOR810GD Mini Closed Probe, 4mm \$87.00/ea

JOR810GE Mini Closed Probe, 5mm \$87.00/ea

JOR810GF Mini Closed Probe, 6mm \$87.00/ea

JOR810GG Mini Closed Probe, Rectangular Mini Closed Probe, 1.5mm x 3mm \$87.00/ea

JOR810GH Mini Closed Probe, Rectangular Mini Closed Probe, 2.5mm x 5mm \$87.00/ea

BUY NOW

Jorvet Palate Closed Probe.

Shaft angled at 80° for easier visualization. **Jorvet**

JOR810HA Palate Closed Probe, 6mm \$115.00/ea

JOR810RA Malleable extensions \$57.00/ea

Used with any spray tip or contact probe to change angle of spray while keeping unit upright.

JOR810RB Right Angle Adaptor \$50.00/ea

*Shaft angled at 80° for easier visualization. **Jorvet***

13822 WEST BOULTON BLVD. METTAWA, IL 60045

WWW.SHOPMEDVET.COM

Phone 800-544-7521

217

Fax 800-204-2177

Equipment & Furnishings

Stools & Medical Storage Cabinets

Classic Series Medical Seating

Medical stools in classic chrome construction comprise this collection of timeless favorites. Features: Chrome base construction Easy spin/thread adjustment Steel mounting plate secures seat to 2" base rubber wheel casters. Height ranges from 19" to 25" (approx). Smooth machine screw height adjustment. Solid steel machine screw shaft. Round foot ring. 1" welded tubular frame. Stool frame is completely chrome plated. Heavy duty seat mounting plate. 14" diameter seat. 4 1/2" thick padded seat for comfort. Available in following colors: Black, Gunmetal, Dove Gray, Desert Tan, Cream, Clamshell, China Green, Emerald, Tomato, Yellow, Slate Blue, Wedgewood, Royal Blue, Mulberry, Purple Gray, Burgundy



BUY NOW

2100	w/square foot ring	\$108.00/ea
2100-CC	w/square foot ring and carpet casters	\$119.00/ea
2102-CC	w/round foot ring and 2" dual wheel hooded casters	\$120.00/ea
2102	w/round foot ring and 2" rubber wheel, ball bearing casters	\$120.00/ea
2102SEAT	For 2102 Clinton	\$30.00/ea
2192	w/round foot ring, 4" add. Height	\$165.90/ea

Navy Premium Pneumatic Stool w/Back Rest

5 legged pneumatic stool, easy single lever seat, height adjustment ranging from 16 1/2" to 24 1/2". Easy to clean 16" diameter set is padded with 4 1/2" foam. The 23" brushed aluminum base is equipped with hooded dual wheel casters.

JOR809PFR \$364.00/ea **BUY NOW**

Navy Blue Laboratory Stool

5 legged pneumatic stool, easy single lever seat, height adjustment ranging from 16 1/2" to 24 1/2". Easy to clean 16" diameter set is padded with 4 1/2" foam. The 23" brushed aluminum base is equipped with hooded dual wheel casters.

JOR809FN \$248.00/ea **BUY NOW**

Navy Blue Laboratory Stool

JOR809PLN \$402.00/ea **BUY NOW**

Jorvet Navy Blue Chrome Base Stool

JOR809N \$156.00/ea



Treatment Cabinet

2 Doors one drawer. Heavy-duty "Bringing You Closer To Home" Brand. MDR868921 2 door 1 drawer cabinet w/casters \$1,100.00/ea

BUY NOW

Metal Cabinet

Heavy-Duty Combination Metal Storage Drawer/Filing Cabinet. Two separate locking systems for storage area and filing drawer. Full suspension locking lateral file drawer accommodates both letter and legal hanging folders. Specify color when ordering. Bringing You Closer To Home is a registered trademark of Medline Industries, Inc. Metal Storage Drawer/Filing Cabinet

MDR907836SD 78"H x 36"W x 18"D \$1,300.00/ea

Supply Cabinet

Our cabinets are built of non-majestic stainless steel and have clear tempered glass for shelves and doors. Stainless steel shelves are also available as an option. Bringing You Closer To Home is a registered trademark of Medline Industries, Inc. 36"W Treatment/Storage Cabinet with two distinct sections separated by a stainless steel work surface

MPH08856 Closed Bottom, Top Glass \$9,500.00/ea



BUY NOW

BUY NOW

Style Line Series Medical Seating

Good looking and hard working. Style Line offers color coordinated durability to any practice or clinic. Features: Contemporary styling One-piece nylon base Three base colors: black, slate, putty Single-lever pneumatic height control "Soft Feel" laminated polyfoam cushion 19 1/2" to 25" height range (approx). Easy single lever pneumatic height adjustment Dual wheel nylon casters. 23" black nylon composite base. 16" diameter seat. 4 1/2" thick padded seat for comfort. Easy clean upholstery BIFMA tested base

2130	Screw height adj, Black base	\$140.00/ea
2135	Pneum, Black base	\$157.90/ea
2135-P	Pneum, Putty base	\$162.00/ea
2135-S	Pneum, Slate base	\$162.00/ea



TOP SELLER

Base Stool Blue Vinyl w/Black Base

This is a pneumatic height adjustable stool. Blue vinyl, base is black color. Five Caster Base.

7100BL Blue Vinyl w/Black base \$111.00/ea

TOP SELLER



Black Chrome Base Stool Jorvet

5 legged pneumatic stool, easy single lever seat, height adjustment ranging from 16 1/2" to 24 1/2". Easy to clean 16" diameter set is padded with 4 1/2" foam. The 23" brushed aluminum base is equipped with hooded dual wheels casters.

JOR809B \$156.00/ea

BUY NOW

Black Premium Pneumatic Stool

JOR809PB \$248.00/ea

BUY NOW

Black Premium Pneumatic Stool w/Back Rest

JOR809PBR \$364.00/ea **Jorvet**

Black Laboratory Stool

JOR809PLB \$402.00/ea

BUY NOW

Medical Storage Cabinet

Can be wall mounted or stored at work station. Durable baked-on epoxy powder finish. 2 shelves per cabinet. 2 clear acrylic windows.

3824M	30"W x 12"D x 30"H	\$446.00/ea
3826M	30"W x 12"D x 26"H	\$344.00/ea



BUY NOW

Treatment Procedure Cart

Lockable drawers. Swivel casters- 2 locking. Storage space - 22 1/2" W x 13 1/4" D x 28 3/4" H Available in autumn white. No. 3803M: Weight: 60 lbs., Drawers: 3 - 3" No. 3805M: Weight: 65 lbs., Drawers: 3 - 3" & 2 - 5 3/4"

3803M	3 Drawer	\$533.00/ea
3805M	5 Drawer	\$578.00/ea



BUY NOW



Equipment & Furnishings

Narcotic Cabinets



Narcotic Cabinet **JorVet**

A narcotic cabinet keeps scheduled drugs safe under lock and key. Our cabinet has two locks that require two different keys for added security. The cabinet also meets DEA guidelines.

- 18g steel in powder-coated beige
- Double lock that has a separate key for each lock
- Spring clip catch keeps door closed
- Can be mounted on a wall or stand alone
- One adjustable shelf
- 56 lb.

JOR367 24"W x 30"H x 10"D \$400.00/ea

Locking Refrigerator Storage Box

Keep your vaccines or pharmaceuticals requiring refrigeration (i.e. Propofol) safe in a secured lock box inside the refrigerator. Box dimensions 8 3/16"W x 10 7/8"D x 3 1/2"H. Easy to mount inside just about any type of refrigerator. Comes with two keys. Mounting directions.

JOR1053 8 3/16"W x 10 7/8"D x 3 1/2"H \$145.00/ea

JorVet

Single Door Double Lock Narcotic Cabinet (A) **BUY NOW**

Perfect for areas short on space or for mobile transit of medications. 20 gauge steel 2 coded tubular cam locks. Available in autumn white.

3802M 8 3/4"W x 6"D x 7 1/4"H \$133.00/ea

Single Door Double Lock Narcotic Cabinet (B) **BUY NOW**

High security cam locks 1 position key release - will not release in open position Heavy duty 20 gauge steel 1 fixed shelf Available in autumn white

3812M 14"W x 8"D x 12"H \$394.00/ea

Double Door Double Lock Narcotic Cabinet (C) **BUY NOW**

Heavy duty 20 gauge steel. High security cam lock 1 position key. Second Door 1 adjustable shelf. Available in autumn white

3822M 12"W x 8"D x 15"H \$490.00/ea

Double Door Double Lock Narcotic Cabinet (D) **BUY NOW**

2 Adjustable shelves. Full length piano hinges. Baked enamel finish. Securely lockable. 1 fixed shelf, 2 adjustable shelves. Fully assembled- ready to use.

3821M 18"W x 8"D x 30"H \$625.00/ea

Single Door Double Lock Narcotic Cabinet (E) **BUY NOW**

Heavy 18 gauge steel exterior. 2 coded tubular cam lock for superior strength and security. 1 fixed shelf, 2 adjustable shelves. Includes mounting hardware. Available in Beige

3901M-2 23.5"W x 10.5"D x 29.5"H \$626.00/ea

Single Door Single Lock Narcotic Cabinet (F) **BUY NOW**

Heavy 18 gauge steel exterior. 2 coded tubular cam lock for superior strength and security. 1 fixed shelf, 1 adjustable shelf.

3901M 24"W x 10"D x 30"H \$478.00/ea

Single Door Single Lock Narcotic Cabinet (G) **BUY NOW**

16 gauge construction 1 adjustable shelf. High security cam locks. 1 position key release - will not release in open position. Available in autumn white. Designed to placed in-wall

3801M 14"W x 3.5"D x 10"H Storage Space \$229.00/ea
Dimensions, Overall Dimensions 16" W x 3 1/2" D x 12" H

Medical Storage Cabinet (H) **BUY NOW**

Constructed of strong 22 gauge steel. Can be wall-mounted or set under work station. Cylinder lock with 2 keys; spring clip door latch. 1 fixed shelf, 2 adjustable shelves.

3902M 30"W x 10"D x 30"H \$444.00/ea

Small Narcotics Cabinet (I) **BUY NOW**

Perfect for areas short on space or for mobile clinics. Double lock door with separate keys. Beige. **JorVet**

JOR367S 8 3/4"W x 7 1/4"L x 6"D. 5 lbs. \$158.00/ea

Keys for JOR367 & JOR367S

JOR367K \$36.00/ea

Equipment & Furnishings

Stainless Steel Carts & Tables

Stainless Steel Utility Cart

These stainless steel regular-duty utility carts are durable and make for easy sanitation. Handle and leg bumpers help protect the cart, walls, corners and legs. Three shelves.

BUY NOW
322C 18"W X 27"D X 33"H \$284.00/ea
311C 15" 1/2"W X 24"D X 32 1/8"H \$250.00/ea

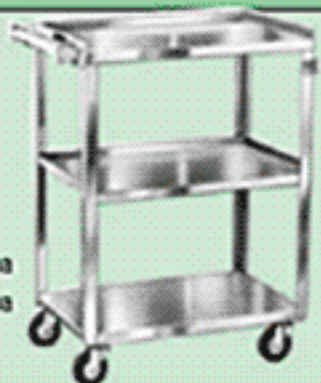

Utility Cart

This utility cart features three adjustable heavy-duty grid shelves. Handle and leg bumpers help protect the cart, walls, corners and legs. 550 lbs. max. capacity. Measures 18" x 30" x 33 1/2" high. Chrome-plated. No tools required for assembly!

BUY NOW
18306 3 Wire Shelves \$119.99/ea



Gurney

This unit is made of 18 gauge medical-grade stainless steel. Casters are 5" and two come with brakes. Solid and sturdy enough for transferring patients or for moving supplies and equipment.

BUY NOW
PLSST40 48"W X 24"D X 36"H \$1,115.00/ea



Surgery Table

The high-tech design of our Stainless Steel Surgery Tables provides added support and stability. The 18 gauge top is die-formed from one solid piece of stainless steel and is polished to a smooth satin finish. Raised edge provides anti-drip top and drain hole on the end has a hook for collecting pail. Tie downs on each side of table provide for easy position of patient. Specifically designed for operating ease and suited with a tilt top mechanism. Top measures 22" x 60". 13 quart bucket not included.

BUY NOW
EL9000 Electric \$2,225.00/ea
VL9020 Hydraulic \$1,855.00/ea



Gel Foam Cushion

This high-resilient foam cushion is embedded with a pressure reduction gel bladder to equalize weight and pressure distribution. The core is made with a proprietary designed gel bladder encased in high resilient polyurethane foam. The casing is a high density durable foam providing support and comfort. A zippered, navy, fluid resistant, nylon cover with urethane backing and a nylon reinforced grey, vinyl bottom; durable, wipeable and easy to care. 16"x16"x2".

BUY NOW
MSCPRC21616 16"x16" \$41.31



Medication Cart

BUY NOW
Medline Medication Carts Combine Security and Mobility to Keep Medications Where They're Needed. Medline's medication carts utilize a Best® solid brass interchangeable mechanism to keep medications secure. A narcotic lock is standard for dual-locking requirements. Carts have storage capacity for additional supplies. Bringing You Closer To Home is a registered trademark of Medline Industries, Inc. Medline 24-Bin Medication Cart Includes Twenty-Four 5" Patient Bins. Overall Exterior Size 27"W x 20"D x 43"H

MPH01WMLAC1 Twenty-Four 5" Patient Bins. Overall Exterior Size 27"W x 20"D x 43"H \$2,500.00/ea
MPH01WMLAC2 4 Drawer 50-3" bins \$3,200.00/ea



Exam Table

BUY NOW
This exam table features a brushed type-304 stainless steel work surface with curved edges, heavy-duty adjustable chrome-plated steel wire shelf and 1 1/2" diameter chrome-plated steel legs with leveling foot. Comes with 4" casters. Table measures 49" x 24" x 35"H

18308 49"W X 24"D X 35"H \$260.00/ea



Stainless Steel Work Table

A sturdy all-purpose utility table of stainless steel with hemmed and rolled front and rear edges. Includes adjustable undershelf and 1 1/2" backsplash. Made from 18 gauge stainless steel.

PL304 48"W X 30"D X 36"H \$920.00/ea
PL305 60"W X 30"D X 36"H \$1,020.00/ea



BUY NOW

Table Topper

This heavy-duty light gray vinyl table mat lays over your existing table top. The Table Topper gives groomers better visibility especially with black animals. This non-slip top lifts off for easy cleaning and tub rinsing.

PLTP1 24" X 36" \$52.00/ea
PLTP2 24" X 42" \$68.00/ea

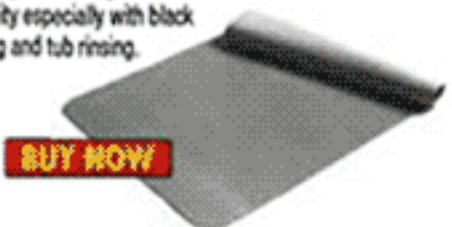

BUY NOW

Surgery/Exam Table

A highly versatile table at an affordable price. Provides a 22" x 44" 18 gauge stainless steel top with raised edge. Height adjustable from 28" to 37" with a larger drawer cabinet. Heavy-duty chrome base revolves 360° and locks in any position. Furnished with tie downs. 5-year warranty on pump.

HY1010 Hydraulic, Fixed-Top \$1,040.00/ea



BUY NOW

Wet tables - Supplies Eyewash Station

Personal Eyewash Station **Jorvet**

Mount on wall to provide immediate relief. This station holds two 32 oz. dosing bottles for thorough decontamination of face and eyes. Comfortable molded eye socket opening allows full flow of solution to completely irrigate affected eye. Imprinted emergency use instructions are on each bottle and station wall. Bottles are shipped empty to fill with water or saline depending on local regulations. Securely mount station with top and bottom holes (hardware included). Measures 17" W x 4" D x 14 1/2" H.

JOR989X Wall-mount \$51.00/ea

BUY NOW



Hair Strainer

PL500 3 1/2" Plastic

\$14⁵⁶/ea

BUY NOW



Hair Trap

PL600 PVC

\$70³⁹/ea

BUY NOW



Pet Bath Hose

BUY NOW

Lightweight durable 5 ft stainless steel hose and spray head. Light enough to be used all day. Spray force and pattern can be altered to work more efficiently

PL972 Spray w/hose \$99.00/ea

Faucet not included



Wet Table Cabinet **BUY NOW**

This multi-purpose, bi-level table/bath is available in two models and is ideal for treatment room needs. The 5" deep end is a comfortable space for bathing. Constructed of 18 gauge steel. Prep rack cover, hair trap optional. Sprayer and faucet not included.

1050-60CAB 60" x 24" x 34" Two Cabinet Doors \$2,453.00/ea

All Purpose Wet Table

All Purpose Wet Table with large knee for close-up procedures. Heavy-duty 6" deep 16 gauge stainless steel liner. Three large extension drawers, storage cabinet. Available in two colors. Prep rack cover, hair trap optional. Sprayer and faucet not included.

LTD750-48 48"L x 24"W x 36"H \$1,810.00/ea

BUY NOW

Walk-In Stainless Steel Tub

A totally stainless steel tub. All parts are stainless steel. Great for all breeds. Fabricated with heavy 18 gauge 304 stainless steel. Swing-in swing-out 18 gauge stainless ramp. 16 gauge round tubing leg and frame assembly. Removable stainless entry allows complete view. Accommodates breeds up to 300 lbs. Available in 48" or 58" lengths. Plumbing on right or left side. Clean out hair trap. 4 back wall eye-hooks.

A048U 48" x 24" x 28"H \$3,109.05/ea

A058K 58" x 24" x 58"H \$3,208.28/ea

BUY NOW

Wet Table with Cabinet and Drawer **BUY NOW**

This multi-purpose, bi-level table/bath is available in two models and is ideal for treatment room needs. The 5" deep end is a comfortable space for bathing. Constructed of 18 gauge steel Table has three large full extension drawers, and one large cabinet prep rack. Sprayer and faucet not included.

950-60DR 60" w x 24" d x 34" h One Cabinet Door, Four Drawers \$2,088.45/ea

Omni Exam Table with Scale

Omni full flush exam table features 4 full extension drawers and a large cabinet with one adjustable shelf. Available in a choice of two laminate colors. All units are 36" high and 24" wide and are available in a variety of tops and lengths. Flush 18 gauge Stainless Steel/Digital Scale 42" Long

202-42DE 42" Stainless Steel With Scale \$2,350.00/ea

BUY NOW

LTD750-48

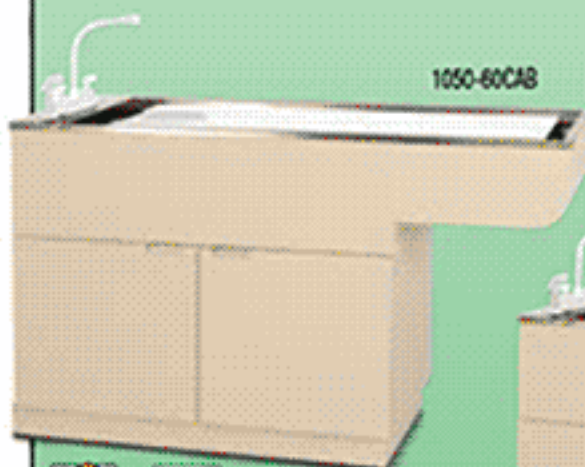

1050-60CAB



950-60DR

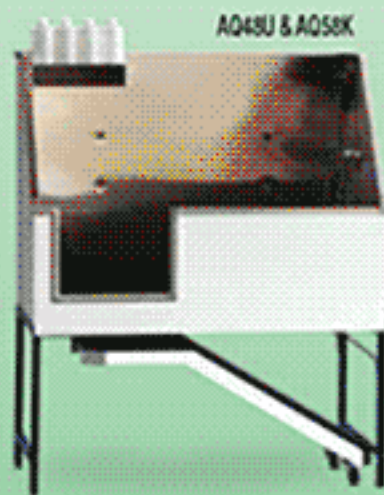

A048U & A058K

202-42DEr

Equipment & Furnishings

Balances & Scales

Portable Digital Scale w/Stainless Tray

This scale is particularly suited to the veterinary industry. With a capacity of 44 lb (20 kg) and readability of 1/2 oz (10g), the scale will accurately weigh infants or small animals. The scale has a "Hold" feature that will capture an unstable weight and keep it on the display for recording after the weight is taken off. The scale can operate on battery (single 9VDC) or AC (adapter included) and comes with a stainless steel weighing tray.

JOR825SS \$169.00/ea

JorVet

BUY NOW



JorVet Walk-On Scale (G)

Clients love to weigh their pets on this walk-on scale. Special software will capture the weight of a moving animal. Stainless steel top with rubber mat to avoid slippage. All units are pre-calibrated and simple to install using the adjustable feet for leveling.

- Weighs Kg (0.1) or pounds (0.2) units with tare function
- Weighs up to 250 Kgs or 500 lbs
- Remote LCD display with 3 meter (10') cord for wall mounting
- 22"W x 36" L x 2"H
- AC with 4 AAA batteries

BUY NOW

JOR825PM Has 6' Cord for Wall Mounting, 36" \$699.00/ea

JOR8250M 42" \$765.00/ea



Samson Digital Hand-held Scale

A modern scale offering all the qualities of a traditional hanging balance with the simplicity, convenience and accuracy of digital operation. Large easy to read LCD display. "Hold" feature for one person operation on heavier loads. A robust, compact and lightweight (0.95 lb/430 g) portable scale. A carrying pouch is supplied for protection when not in use. Complete with weighing handle and battery.

BUY NOW

JOR8260 10 kg x 0.01 kg (22 lb x 0.02 lb/1/4 oz) \$114.00/ea

JOR826R 25 kg x 0.02 kg (55 lb x 0.05 lb/1/2 oz) \$114.00/ea

JOR826S 45 kg x 0.05 kg (99 lb x 0.1 lb/1 oz) \$142.00/ea



Triple Beam Pan Balance

BUY NOW

- Weighing Units: grams
- Readability: 0.1 g
- Capacity: 610 g (without attachment weights)
- Beam Calibrations: 10 x 0.1 g / 100 x 10 g / 500 x 100 g
- Dimensions: scale — 18" (L) x 3" (W) x 5.5" (H)

JOR826X Weighing Platform — 6 diameter (round) \$120.00/ea

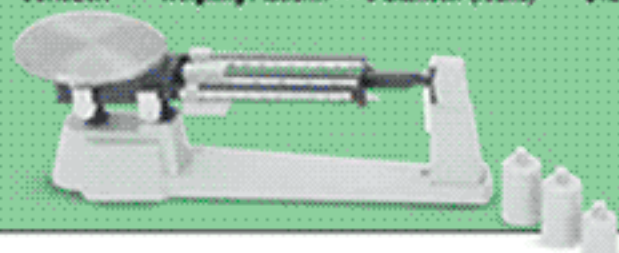

Elite Floor Standing Electronic Scale

Elite Floor-Standing Lateral, Regal 300 Electronic Scale Lift Table

12661-01-GZLWEF \$3,650.00/ea

BUY NOW

MORE SCALES AVAILABLE
IN OUR EQUIPMENT SECTION



Equine Platform Weighing Scale

A horse's weight is important to the veterinarian as well as the horseman. This horse weighing scale is the most accurate available. The scale weighs horses up to 1000kg in increments of 0.2kg. Software features animal averaging to ensure accurate weighing even if the horse is not standing perfectly still on the robust walk-on platform (200cm x 100cm x 8.1cm). Complete with rubber mat for durability, safety and noise reduction and a rechargeable battery-powered indicator with backlit display.

BUY NOW

JOR825E (200cm x 100cm x 8.1cm)

\$2,300.00/ea



JorVet Walk-On Scale

JOR825PB Battery only for scale. \$62.00/ea

BUY NOW

Pocket Balances

JorVet

This elegant-looking product offers unparalleled weighing performance, with the advantage of low cost and affordability. Standard features include grams, ounces, pennyweights and troy ounce weighing modes, parts counting and auto power off to enhance battery life. Offered in a stylish and tough ABS case with a useful top plate cover that protects the weighing platform from accidental damage, while doubling as a draft shield for more accurate weighing. Batteries and a multilingual user instruction manual are included.

- Modes: weighing (g, oz, dwt, ozt), piece counting, auto power off (standard 120 seconds)
- Function Keys: on/off, tare (zero), count, mode (unit switching)
- Display: 0.5" (13 mm) 7 segment LCD
- Temperature limits: 10° C to 35° C
- Power: 2 x 1.5 V AAA batteries (included)
- Dimensions scale: 5.2" x 3.2" x 0.9" (133 mm x 81 mm x 23 mm)
weighing platter: 2.4" x 3.0" (61 mm x 75 mm)
- Weight: 0.3 lbs (135 g)

BUY NOW

JOR826B 500gm \$135.00/ea





Pet Cage Systems

BUY NOW

This cage comes with heavy-duty hinges, removable cage doors for easy cleaning and are made of 3/4" moisture resistant marine plywood with a protective stainless steel molding. Features an advanced latching system that allows for single hand operation of cage doors. Surfaces are fully laminated and have stainless steel moldings for easy cleaning. Trim available in black, dove grey and white. Large 4" heavy-duty casters rotate 360°. Unit sizes below.

Single Units

SSAC1	18"W x 18"H x 24"D	\$307.04/ea
SSBC2	24"W x 22"H x 24"D	\$367.64/ea
SSCC3	36"W x 30"H x 24"D	\$519.14/ea

Cage Systems

SSDD4	30"W x 36"H x 24"D	\$519.14/ea
SSC1	4 SSCC3 Units	\$2,078.58/ea
SSC2	4 SSAC1, 3 SSBC2, 2 SSCC3 units	\$4,378.00/ea
SSC3	6 SSBC2 units	\$2,206.00/ea
SSC4	6 SSBC2, 2 SSCC3 units	\$3,246.00/ea
SSC5	16 SSAC1 units	\$4,940.92/ea
SSC6	9 SSBC2 units	\$3,309.00/ea



Banked Cage

BUY NOW

These fiberglass cage units are white and come complete with a roller base, floor grates and a unique latching system. Basic unit measures 61" wide x 26" deep x 74 1/2" high. Total shipping weight is 350 lbs. Pans and feeder doors not included.

126W4	Four Cages Two rows of two 30x30x24D	\$2,359.80/ea
126W5	Five Cages One row of two 30x30x24D One row of three 20x20x24D	\$2,468.85/ea
126W8	Eight Cages Two rows of three 20x20x24D One row of two 30x30x24D	\$3,317.40/ea
126W9	Nine Cages Three rows of three 20x20x24D	\$2,771.85/ea

Banked Cage Trays

Accessory Trays are made from easy to clean, durable plastic. Designed to fit Banked Fiberglass Cages.

126LT	Plastic Tray For 30" x 30" Cages, Crate weight 5lbs	\$35.00/ea
126ST	Plastic Tray For 20" x 20" Cages, Cage 3lbs	\$23.50/ea

Equipment & Furnishings

Cages & Misc Supplies



Multi Unit Cage

This one-piece chrome-plated cage comes with six sections measuring 24" x 24" x 24". Features six 2" x 2" galvanized pans, one-hand operating latch, bright plating and sturdy casters for mobility. Entire unit measures 48" wide x 24" deep x 72" high. Total shipping weight is 219 lbs and comes in two containers. Floor grates available in a one pack or six pack, and are made of 4- & 9-gauge wire with 1/2" to 1 1/2" openings. Grates are sold separately. Grates are sold separately.

- | | | |
|-----|---|-------------|
| W67 | • 6 Cage Unit | \$712.00/ea |
| | • Six heavy-duty, galvanized steel pans | |
| | • 4 & 9 Gauge Wire | |
| | • Folds flat for storage | |

Multi Unit Cage Floor Grates

BUY NOW

- | | | |
|--------|------|-------------|
| W67G | 6/bx | \$202.50/bx |
| W67G-S | Each | \$33.00/ea |

Jorvet Cage Card Holder

BUY NOW

Stainless steel card holder that fits most brands of stainless steel cages by sliding tightly onto cage bars

- | | | |
|---------|---|-----------|
| JOR461X | Stainless Steel ID Card Holder Standard 3 x 5 | \$7.20/ea |
|---------|---|-----------|

Paper Towel Dispenser

BUY NOW

These paper towel dispensers measure 12 1/8" x 5 1/8" x 14 3/8" tall and are available in painted white, chrome and stainless steel. Can be used with multi-fold paper towels. C-chrome, S-stainless steel, W-white enamel.

- | | | |
|-------|------------------------|------------|
| PTD-C | Chrome Finish | \$55.00/ea |
| PTD-S | Stainless Steel Finish | \$90.00/ea |
| PTD-W | White Enamel Finish | \$39.00/ea |



Multi-Fold Towel

Multi-fold towels, 9.25" x 9.5", 4000/cs. various manufacturers.

- | | | |
|---------|-------|------------|
| P-TOWEL | White | \$24.00/cs |
|---------|-------|------------|



Paper Towel C-Fold

High-quality single towels help prevent waste and cross-contamination

- | | | |
|-------------|------------------|------------|
| TOWEL-CFOLD | 2400/Case C-Fold | \$30.29/cs |
|-------------|------------------|------------|



NEED O.R. TOWELS OR DRAPES?
SEE OUR SURGICAL SECTION FOR A FULL SELECTION OF
OR TOWELS, DRAPES & INSTRUMENT WRAPS

Coated Cage Rack

BUY NOW

PVC-coated expanded metal floor racks are a must for animal comfort and hygiene. The racks are dipped in plastisol for a uniform 1/8" coating. The diagonal grid is easy to clean with virtually any disinfectant. This coating gives the patient a softer and drier resting place while under your care. The racks are elevated 3/4" allowing the patient to remain dry and clean. Guaranteed against breakage for 3 years. Fits Shor-Line®, Surburban® and VSSI cages.

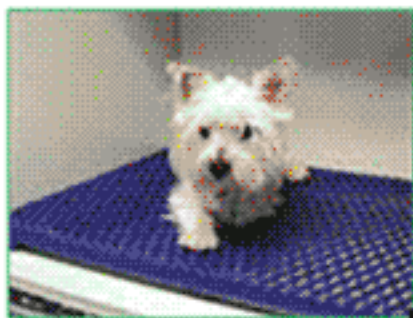

- | | | |
|---------|--|-------------|
| JOR840P | 15" x 27 3/4", 9 lbs. For 18" cage. | \$81.00/ea |
| JOR840Q | 21 1/4" x 27 3/4", 13 lbs. For 24" cage. | \$94.00/ea |
| JOR840R | 27 1/2" x 27 1/2", 16 1/2 lbs. For 30" cage. | \$111.00/ea |
| JOR840S | 32" x 27 3/4", 20 1/4 lbs. For 36" cage. | \$138.00/ea |



Roll-Around Caddy

BUY NOW

Constructed of high-intensity injection molded polystyrene plastic. Features four hooded casters and five removable storage bins that can be hung on top of the cart from either side.

- | | | |
|--------|-------------------------|-------------|
| PL275A | Tool Panel for PL2175 | \$89.76/ea |
| PL2175 | 12.75W" x 15.50" x 35H" | \$270.00/ea |

Roll Caddy W/Door Lock

- | | |
|------|-------------|
| 2176 | \$357.00/ea |
|------|-------------|

BUY NOW



Video Oscopes & Accessories

BUY NOW

Video Oscope System

Rod lens scope offers a great image for viewing the ear canal, oral cavity or other body areas (i.e., the vaginal tract).

JOR6950M \$11,281.25/ea **JorVet**

Illumination Cable

JOR695EC \$252.00/ea **BUY NOW**

Jorvet Video Oscope

Rod lens scope offers a great image for viewing the ear canal, oral cavity or other body areas (i.e., the vaginal tract). 5mm Scope with a 2mm channel that has a luer fitting, and a removable ear cone attachment.

JOR695E 3mm, Fully soakable. \$1,740.00/ea



Jorvet Endoscope

BUY NOW

JORS11 2.7mm x 18cm \$2,700.00/ea
 JORS11A Sheath 4mm with Stopcock \$350.00/ea
 JORS11B Trocar/Obturator \$85.00/ea

Jorvet Operating Sheath

JORS11S 2.7mm with channel \$700.00/ea

Jorvet Light Guide Cable

JORS11C 3.5mm x 180cm \$325.00/ea

Jorvet Biopsy Forceps

JORS11BFA Flexible for 2.7mm Scope \$130.00/ea

Jorvet Rigid Biopsy Forceps

JORS11BR 3mm cup \$510.00/ea

Flexible Biopsy Grasper for 2.7mm scope

JORS11GFA 2.7mm; for flexible 2.7 scope \$130.00/ea

Flexible Endoscope Complete

All endoscopes include:

- Carrying/storage case
- Channel cleaning brush
- Insufflation tubing
- Suction tubing
- One-year warranty

JORS6501 Forceps 1.8mm x 175cm \$365.00/ea

JORS66 6.4mm x 100cm Complete \$4,800.00

JORS65 8mm x 145cm, submersible \$9,800.00/ea



BUY NOW

Jorvet Flexible Endoscope

BUY NOW

JORS64 9.9mm x 125cm \$8,100.00/ea

JORS66 6.4mm x 100cm Complete \$4,800.00

JORS66A 6.6mm x 100cm \$7,560.00/ea

JORS67 3mm x 87 cm \$2,280.00/ea

JORS68 14.4mm x 200cm \$10,080.00/ea

JORS68A Three Meter \$11,760.00/ea

Jorvet Basket Retrieval Forceps

JORS6407 1.8mm x 180cm \$300.00/ea



JORS68A

Mini-Vid Microscope Eyepiece Camera

This is the ideal camera for watching your microscope slides on TV. The small camera slips into your microscope's eyepiece and hooks directly to any TV. Focus through remaining eyepiece. Fits all brands of microscopes and RCA plug-on end fits all TVs or VCRs.

- 400 line resolution
- Very affordable
- 110V adaptor to 12V
- 8' cord
- 3 oz.

JOR822 \$480.00/ea



BUY NOW

Minivid 8.1 Megapixel USB Camera

BUY NOW

- Camera, plus configured with USB port connection to the computer.
- Includes IBM and windows compatible software
- Captures images to digital file for archiving and transmission
- Client education: allows comparison of normal versus abnormal cases (i.e. semen evaluation)

JOR8220M 8.1 Megapixel \$520.00/ea

JorVet



Minivid Camera, 1.3 Mega Pixel

This is the ideal camera for watching your microscope slides on TV. The small camera slips into your microscope's eyepiece and hooks directly to any TV. Focus through remaining eyepiece. Fits all brands of microscopes and RCA plug-on end fits all TVs or VCR's. • Very affordable • 110V adaptor to 12V

JOR822M 1.3 Mega pixel for JOR822 \$549.00/ea

BUY NOW

MiniVid camera w/USB Connectors

- JOR822 camera, plus configured with USB port connection to the computer. 3 megapixels. *Computer not included*
- Includes IBM and windows compatible software
- Captures images to digital file for archiving and transmission
- Client education: allows comparison of normal versus abnormal cases (i.e. semen evaluation)

JOR8220 With USB connector \$520.00/ea

JorVet



Flushing/Aspiration Pump & Bottle Assembly

JOR695XA \$660.00/ea **BUY NOW**

Flushing/Aspiration Pump for Video Oscope

JOR695X \$353.00/ea **BUY NOW**

Guttural Pouch Probe

JOR56403 \$84.00/ea **BUY NOW**



Equipment & Furnishings

Medical Cases, Heated Blankets and pads

Mohr Medical Case

BUY NOW

This durable heavy-duty veterinary grip helps you organize and take care of large animal pharmaceuticals and equipment. 9"W x 22"L x 12 1/2"H.

- Superb quality and craftsmanship
- Produced from durable Cyclocac material
- Manufactured since 1976
- Designed for rugged use
- Stainless steel hinges and locks
- Individual compartments fit to order
- Rudders on bottom
- Easy aseptic cleaning
- Stain resistant
- Space allowance for 100, 250, & 500cc bottles



JOR346 9"W x 22"L x 12 1/2"H \$470.00/ea

Pocket Spacer

JorVet

JOR84301 \$30.00/ea

BUY NOW



Push Up Box for Kim Wipes®

The PUSH-UP-BOX™ has been designed to give perfect dispensing of laboratory Kimwipes. The PUSH-UP-BOX™ prevents the top most tissue from falling back into the Kimwipes box. No installation necessary. Also works with Lab wipes JOR889. Kimwipes® is a trade mark of Kimberly Clark.



BUY NOW

JOR1037 Double High Impact polystyrene, Weight 9.6 oz. \$17.50/ea

JorVet

Jorvet E-Z Lift

A simple device to aid in rehabilitation or physical therapy. Any back surgery or hind limb weakness will be helped along with the use of this device. Straps can be adjusted with double-bar buckles. Washable nylon cloth.



BUY NOW

JOR743A large \$10.50/ea

JOR743S set of 2 \$19.50/ea

JOR743 small \$9.90/ea

Jorvet Thermal Jacket

JorVet Thermal Pad is a very effective, economical source of providing warmth to retain or increase body temperature for your veterinary patients. Thermal heat is circulated by standard warming blanket placed between two sturdy sheets of 21" x 27" polypropylene 5/8" thick. This plastic pad has a smooth surface for easy cleaning and is extremely puncture resistant. This system connects to our Thermal Pump (JOR783), and comes with connectors to adapt to other circulatory water pumps on the market.

JOR784W \$102.00/ea

BUY NOW



Plastipad Urethane Blanket **JorVet**

Constructed of rugged urethane that is lightweight with extra strength that resists punctures. Seam strength is triple that of vinyl. Urethane is easy to clean.

JOR784D 12" x 18" \$218.00/ea
 JOR784E 22" x 30" \$240.00/ea



Maxitherm Vinyl Blankets

Vinyl material is less expensive but not as durable as the urethane blankets. Large, 24" x 60".

BUY NOW

JOR784C 24" x 60" \$64.50/ea
 JOR784A 12" x 18" \$49.50/ea



JorVet

Y-Connector for Heating Mat

Total length 6ft. 4ft hose then Y's, 2ft length on each Y.

JOR784DC 2ft length on each Y. \$84.00/ea

BUY NOW

JorVet



Protect-A-Pad Cover Fits

There is a widespread use of circulating hot water blankets in veterinary medicine. An animal's sharp claws can very easily puncture these blankets. These cover pads are a soft padded, quilted cotton that protects the water blanket and provides comfort for the patient. The blanket has excellent heat transference and is inserted between the pad layers with Velcro closes. Protect-A-Pads work with most brands of circulating hot water blankets. Machine washable.

JOR784D 18" x 24" \$38.50/ea
 JOR784R 22" x 30" \$54.00/ea

Re-usable Connecting Hose

JOR784G \$65.00/ea

BUY NOW



Gaymar Blanket/Pump Connectors

These quick-release connectors allow connection to other brands of hot water pumps and blankets (i.e., Gaymar and Baxter). All Jorvet blankets come fitted with a male connector and an extra female connector. The female connector allows a hose from any brand pump to be connected to our blanket.

JOR784K Male \$21.00/pr
 JOR784Y Set of male and female \$45.00/pr
 JOR784Z Female \$27.00/pr

BUY NOW



Equipment & Furnishings

Smoke Shark, Soak Trays & Drenchers

Jorvet Smoke Shark **BUY NOW**

Noxious smoke is generated when using either an electrosurgical unit or surgical laser. At the very least smoke is a nuisance odor, and at worst, an occupational health hazard. The smoke shark is designed to remove smoke and particulate matter generated by electrosurgical generators or lasers at the operative sight. The Smoke Shark unit consists of a smoke evacuation power unit, filter canister, and various tubing attachments. The four stage filter captures particles down to 0.01µm with over 99.99 percent efficiency. The filter has an 18-hour shelf life and contains 24 ounces of carbon giving it superior ability to eliminate odors. Tubing (6) connects the filter to the surgery site. A small arm stand holds the tubing close to the surgical site without contaminating the sterile field.

Features:

- Line voltage: 120 VAC ± 10%
- Line frequency: 50-60 Hz
- 17.78 cm (7") W x 29.85 cm (11.75") H x 46.36 cm (18.25") D
- Weight: < 6.5 kg (< 14 lbs.) w/o filter

JOR483	Complete with:	\$1,960.00/ea
	• Smoke Shark power unit	
	• Long life filter	
	• 6" tubing (24/pk)	
	• Foot switch	
	• Arm stand	

Smoke Shark Accessories

Laser resistant Smoke Shark Wand

For laser use.

JOR48303	Tubing, 7/8" x 6 ft. (24/pk)	\$188.00/ea
----------	------------------------------	-------------

Smoke Shark Footswitch

JOR48304	\$188.00/ea
----------	-------------

Smoke Shark Accessories

Smoke Shark power unit only

JOR48306	\$1,410.00/ea
----------	---------------

Smoke Shark Arm Stand

JOR48305	\$176.00/ea
----------	-------------



Jorvet Sink Soak Tray **BUY NOW**

A perforated tray with handles. Perfect for soaking delicate and sharp instruments after surgery. Eliminates "fishing" out sharp instruments with bare hands. Made from fiberglass reinforced plastic that can be autoclaved up to 350° F.

JOR365	Small	\$69.00/ea
JOR365L	Large	\$84.00/ea

Jorvet

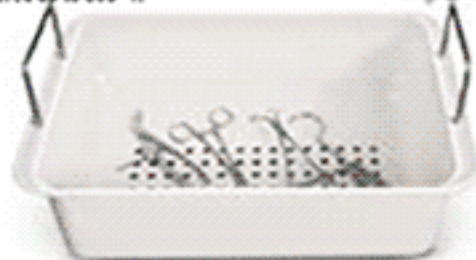

Endoscope Soak Trays

Most rigid endoscopes should be immersed in sterilization solution for 15 minutes before use. This tray consists of a perforated soaking basket that holds the endoscope and is lifted out after proper soaking. Made of fiberglass reinforced plastic that can be autoclaved up to 350° F. Cover included. Tray: 24" x 8" x 57/8".

- Basket: 22 1/2" x 6 3/8" x 4 3/4".
- Cover: 24" x 8" x 1/2".

JOR366	24"	\$128.00/ea
JOR366L	36"	\$141.50/ea

Jorvet



BUY NOW

Light Source Complete

Features high intensity 150w halogen light; controlled manually by a light intensity knob. Automatic air. Factory wired to accommodate both.

JOR509	110/220 volt	\$1,050.00/ea
--------	--------------	---------------

Metal Halide Illuminator

JOR569MH	\$2,640.00/ea
----------	---------------

BUY NOW



Portable Light Source

This light source comes with a power cord, lithium ion battery, battery charger, and it is a LED light source. Dimensions 8" x 2 1/2".

JOR569P	8" x 2 1/2"	\$702.00/ea
---------	-------------	-------------

Jorvet

Foot Operated Dispenser with Foot Pump

Blue. Remove cover to refill, capacity 28 fluid oz. (828 ml). Includes wall bracket mount for easy detachment and cleaning. Complete with 6 CE (2 meter) medical grade PVC tubing.

JOR839	NOTE: spare parts available	\$110.00/ea
--------	-----------------------------	-------------

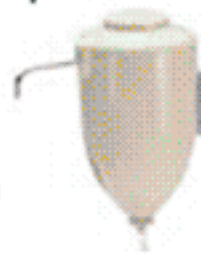

BUY NOW

Water Bottle w/ lid and Tubing for Endoscope

JOR565D7	\$210.00/ea	BUY NOW
----------	-------------	----------------

Bovine Easy Drencher



BUY NOW

The use of old wine glass bottles for drenching cattle is a thing of the past. The Easy Drencher was developed in New Zealand and is used world wide for drenching. Easy grip handle, 1.2 liter capacity/graduated in 100ml increments, 12cm long-safe nozzle, side neck for easy filling of liquid or powders.

JOR1021	Complete	\$28.80/ea
JOR1021D1	Extra Probe (only) for Easy Drencher	\$13.50/ea

13822 WEST BOULTON BLVD. METTAWA, IL 60045

WWW.SHOPMEDVET.COM

Phone 800-544-7521

Fax 800-204-2177

Vectra Genisys Systems

Vectra® Genisys Laser System

Large easy to read screen

- 9 cluster style 1040mW total power applicator Laser diodes at 850 nm/200mW (5) LED diodes at 670nm/10mW (4)
- Continuous and pulse operation
- Real time feedback of delivered dosages
- Ergonomically designed laser applicators conform comfortably to the hand
- Therapy can be controlled by the handheld applicator
- Protective laser eyewear IS INCLUDED!
- Two year warranty on unit, one year on laser head

JOR1013 Complete System \$4,200.00/ea

BUY NOW

Vectra® Genisys Laser System Parts

Large easy to read screen

- 9 cluster style 1040mW total power applicator Laser diodes at 850 nm/200mW (5) LED diodes at 670nm/10mW (4)
- Continuous and pulse operation
- Real time feedback of delivered dosages
- Ergonomically designed laser applicators conform comfortably to the hand
- Therapy can be controlled by the handheld applicator
- Protective laser eyewear IS INCLUDED!
- Two year warranty on unit, one year on laser head

JOR1013D5 transport laser w/o laser applicator \$1,462.00/ea

JOR1013D6 9 Diode cluster applicator (LED & Laser) \$2,825.00/ea

Equine Vectra® Genisys Laser System

- Same features as JOR1013 small animal system
- 33 cluster style* laser applicator, 1440mW total power Laser diodes at 850nm/200mW (5) SLD diodes at 880nm/25mW and 950nm/15mW (8 + 8) LED diodes at 670nm/15mW (12)
- Two year warranty on unit, one year on laser head

JOR1013E \$4,245.00/ea

Equine Vectra® Genisys Laser System Parts

JOR1013D7 33 Diode cluster applicator \$3,136.00/ea

Therapy System Carrying Bag

Optional accessories for JOR1013

JOR1013D1 \$230.00/ea

JorVet



BUY NOW



BUY NOW



Jorvet Intellect® Vet system

BUY NOW

Intellect Vet is fully functional in the clinic or in an environment where mobility is a must. An optional battery module lets you perform therapy away from electrical outlets. With the optional carry bag, you can easily transport and store the unit and accessories.

- Veterinary specific software
- 5cm ultrasound applicator
- 2-channel Electro Stim package
- Ultrasound gel
- User manual
- Starter package of Dura-Stick electrodes



JorVet

NEW

JOR2756K Clinical Indications* for Dogs and Horses \$3,830.00/ea

- Electrotherapy
 - Muscle relaxation
 - Prevention or retardation of disuse atrophy
 - Increase local blood circulation
 - Muscle re-education
 - Maintaining or increasing range of motion
 - Pain relief
- Ultrasound Therapy
- Pain relief
 - Relief of muscle spasm (see previous page for information on lasers)
 - Relief of joint contractures
- Laser Therapy Unit Optional



Equipment & Furnishings

Specialty Forceps, Aspiration Supplies & More

Adjustable Head Lamp

Proper lighting insures a better exam and diagnosis. This head lamp illuminates viewing area and is hands free. Focusable with standard and halogen bulbs. Operated by three AA batteries. Battery case on top of head.

JOR699 w/ head mount battery \$125.00/ea



BUY NOW

Jorvet Aspiration Kit

A hollow tube with a luer attachment on one end. The flushing of saline allows a sample to be obtained (i.e., a tracheal wash via a syringe). Packaged sterile in tear-open pouches, complete with directions.

JOR727	2.0mm x 100cm	\$9.90/ea
JOR727A	2.0mm x 140cm	\$12.00/ea
JOR727B	2.6mm x 140cm	\$12.00/ea
JOR727C	2.6mm x 170cm	\$14.40/ea
JOR727D	2.6mm x 250cm	\$19.50/ea

NEW

BUY NOW

Jorvet Aspiration Suction Unit

This portable unit will provide powerful suction via an aspirator pump motor. Intraoperative suction of blood or body fluids. Attach to endoscope to keep field of vision clear or sample collection.

Features:

- Aspiration range 0-27" Hg
- Powerful 1/5 hp motor, most other units have only 1/10 hp
- Compact 14"L x 5 1/2"W x 10 1/2"H (35cm x 14cm x 26cm)
- In line hydrophobic filter protects motor
- 800cc Storage canister
- Lightweight 12.4 lbs.
- Five-year warranty

JOR459 14"L x 5 1/2"W x 10 1/2"H \$350.00/ea



NEW

BUY NOW



Biopsy forceps Fenestrated Cup w/needle

JORS64D1
1.8mm x 175cm \$365.00

JORS68D1
2.5mm x 230cm \$365.00

JORS64D1A
1.8mm x 120cm \$365.00

JORS68AD2
for 3 meter scope \$365.00

JORS64D1B
1.8mm x 180cm \$365.00

BUY NOW



3-prong grasping forceps

JORS64D2
1.8mm x 175cm \$365.00

JORS64D2B
1.8mm x 180cm \$459.00

JORS68D2
2.4mm x 225cm \$365.00

JORS64D2A
120cm x 1.8mm \$365.00

JORS68AD1
2.3mm x 330cm, for 3 meter scope \$618.00

JORS64D2B
1.8mm x 180cm \$459.00

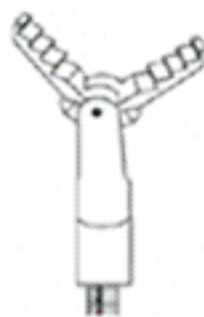

Alligator Serrated Grasping Forceps

JORS64D5
1.8mm x 175cm \$365.00

JORS68D3
2.4mm x 225cm \$365.00

JORS64D5A
1.8mm x 120cm \$365.00

BUY NOW



Alligator Serrated Biopsy Forceps w/ Piercing needle

JORS64D4
1.8mm x 175cm \$365.00

JORS68D4
2.4mm, 225cm \$365.00

JORS64D4A
120cm x 1.8mm \$365.00

JORS68AD3
1.8mm, 3 meter \$618.00

JORS64D4B
1.8mm x 180cm \$460.00

BUY NOW



Rat Tooth Grasping Forceps

JORS64D6
1.8mm x 175cm \$365.00

JORS68D6
2.4mm, 225cm \$370.00

JORS64D6A
1.8mm x 120cm \$365.00

BUY NOW

Orthopedic Products

Cast Padding, Stockinette & Fiberglass Tape

Cast Padding

BUY NOW

This top-quality synthetic cast padding comes rolled and sold in bags. Cast padding provides a smooth, snug, under-cast finish. Comfortably fits contours and prominences without slipping. Makes an excellent under-cast protection.

CP2	12 rolls/Bg	\$6.00/bg
CP3	12 rolls/Bg	\$6.00/bg
CP4	12 rolls/Bg	\$6.50/bg
CP6	6 rolls/Bg	\$6.50/bg



Cotton Cast Padding

This product is constructed of 100% pure cotton fibers to provide a soft environment under a hard cast.

CCP3	3" X 4 yds 12/Bg	\$8.99/bg
CCP4	4" X 4 yds 12/Bg	\$12.99/bg
CCP6	6" X 4 yds 6/Bg	\$10.25/bg



BSN Specialist Cast Padding

Cotton and Rayon Blend for excellent absorption. Micropleated design results in conformability, protection, and ease of application.

9062	2" x 4yd, 24/pack	\$14.95/pk
9046	6" x 4 yds, 6/pk	\$10.50/pk
9044	4" x 4yd, 12/pack	\$14.95/pk
9043	3" x 4yd, 12/pack	\$10.95/pk



Specialist Cast Padding

Made from 100% cotton fibers, Specialist® 100 cast padding is designed to provide under-cast protection and wick away body exudates while offering the comfort and breathability of pure cotton. This cast padding fits body contours without slipping, maximizing patient protection and comfort throughout the healing process.

9082	2" X 4 yds, 24/BG	\$18.58/bg
9083	3" X 4 yds, 12/PK	\$12.88/bg
9084	4" X 4 yds, 12/PK	\$18.03/bg
9086	6" X 4 yds, 6/PK	\$13.00/bg



Jorvet X-Lite Foam Cast Padding

Light green, lightweight open-cell foam padding. Great for cast padding or protecting bony protuberances.

JOR759	7.5cm (3") x 2.75m (107"). 10 rolls/pk	\$28.50
JOR759A	13cm (5.2") x 2.75m (107"). 10 rolls/pk	\$40.50



Jorvet Cotton Stockinette

Useful for protecting extremities prior to splinting. Use as non-adhesive liner under a splint for small and large animals. Stockinette is removable and washable.

JOR291AC	1" x 25 yds.	\$14.70/ea
JOR291BC	2" x 25 yds.	\$29.40/ea
JOR291CC	3" x 25 yds.	\$25.50/ea
JOR291DC	4" x 25 yds.	\$30.00/ea
JOR291EC	6" x 25 yds.	\$45.00/ea



Jorvet Ortho Stockinette

JOR291B	2" x 25 yds.	\$15.90/ea
JOR291C	3" x 25 yds.	\$23.70/ea
JOR291D	4" x 25 yds.	\$27.60/ea
JOR291E	6" x 25 yds.	\$37.50/ea



Stockinette

BUY NOW

Heavyweight, premium-grade, tubular stockinette for use under and over casts. Protects skin under plaster casts. Dispenser box simplifies cutting for exact fit. Can also be used for other dressing applications. 25 yards per box.

SN2	2" X 25 yds	\$6.95/ea
SN3	3" X 25 yds	\$9.95/ea
SN4	4" X 25 yds	\$12.95/ea
SN6	6" X 25 yds	\$17.95/ea



Orthopedic Stockinette

High-grade, unbleached, absorbent, knitted cotton is an ideal material for undercast layer. Stretches to three times its width. 1 r/box.

9071	1" X 25 yds, Each	\$14.35/ea
9072	2" X 25 yds, Each	\$28.25/ea
9073	3" X 25 yds, Each	\$38.81/ea
9074	4" X 25 yds, Each	\$52.06/ea



Orthopedic Casting Tape

BUY NOW

This strong, durable casting tape will allow for sturdy support of those casted limbs. They are easy to prepare, easy to use and very inexpensive! Orthopedic or fiberglass casting tape activates by dipping in water, then sets in seven minutes. Finished casts are lightweight, strong, porous and easily removed with cast cutter. No choice of color. 10 rolls/box.

FG6	6" X 4 yds	\$65.00/box
FG2	2" X 4 yds	\$35.00/box
FG3	3" X 4 yds	\$45.00/box
FG4	4" X 4 yds	\$55.00/box
FG5	5" X 4 yds	\$60.00/box



3M Fiberglass Casting Tape

BUY NOW

A lightweight, strong and durable casting tape that combines the benefits of fiberglass casting tape with the handling ease of plaster. Made from water-activated resin which allows easier, tack-free application. No choice of color.

3MFG2	2"	\$8.50/ea	
3MFG3	3"	\$9.50/ea	10+ \$7.90
3MFG4	4"	\$10.50/ea	
3MFG5	5"	\$11.50/ea	10+ \$9.90



JorVet Fiberglass Casting Tape

fiberglass mesh that is impregnated with polyurethane. It is activated by submersion in water. Many competing tapes are only 3 yards long!

JOR574A	2" x 4yds., 5/cs	\$40.00/cs
JOR574B	3" x 4 yds., 5/cs	\$45.00/cs
JOR574C	4" x 4 yds., 10/cs	\$111.00/cs



We do not stock all Orthopedic Products. Note that Jorvet/Jorgensen brand Products have a \$10 Dropship fee, as well as extra overnight fees.

13822 WEST BOULTON BLVD. METAWA, IL 60045

WWW.SHOPMEDVET.COM

Phone 800-544-7521

280

Fax 800-204-2177

Fiberglass Cast Tape



Delta-Lite Plus Fiberglass Cast Tape

BUY NOW

Delta-Lite Plus is a new fiberglass cast tape that combines a fiberglass substrate and advanced water activated polyurethane resin system which provides tack-free properties. The tack-free properties allow ease of application and molding using standard examination gloves.

Features and Benefits

Very Smooth surface - Less abrasive finished cast enhances patient comfort while it reduces clothing snags

- Excellent rigid support (immobilization) - Creates long-lasting, light weight cast
- High lamination - Creates a strong bond between layers ensuring a strong finished cast
- New resin formulation - Use exam glove of your choice. Improves unrolling tension improving ease of cast application
- Good conformability - Makes casting application easier with change of anatomy
- Outstanding molding - Produces an anatomically correct cast



7345800	1" X 2 yds, White,10/BX	\$46.51/bx
7345801	2" X 4 yds, White,10/BX	\$62.02/bx
7345802	3" X 4 yds,White,10/BX	\$73.64/bx
7345803	4" X 4 yds, White,10/BX	\$91.09/bx
7345804	5" X 4 yds, White,10/BX	\$116.28/bx
7345845	2" X 4 yds, Black,10/BX	\$62.02/bx
7345846	3" X 4 yds, Black,10/BX	\$73.64/bx
7345847	4" X 4 yds, Black,10/BX	\$91.09/bx
7345860	2" X 4 yds, Purple,10/BX	\$62.02/bx
7345861	3" X 4 yds, Purple,10/BX	\$73.64/bx
7345862	4" X 4 yds, Purple,10/BX	\$91.09/bx
7345855	2" X 4 yds, Pink,10/BX	\$62.02/bx
7345856	3" X 4 yds, Pink,10/BX	\$73.64/bx
7345857	2" X 4 yds, Deep Red,10/BX	\$91.09/bx
7345831	3" X 4 yds, Deep Red,10/BX	\$73.64/bx

7345830	2" X 4 yds, Deep Red,10/BX	\$62.02/bx
7345820	2" X 4 yds, Deep Blue,10/BX	\$62.02/bx
7345821	3" X 4 yds, Deep Blue,10/BX	\$73.64/bx
7345822	4" X 4 yds, Deep Blue,10/BX	\$91.09/bx
7345823	5" X 4 yds, Deep Blue,10/BX	\$116.28/bx
7345825	2" X 4 yds, Deep Green,10/BX	\$62.02/bx
7345826	3" X 4 yds, Deep Green,10/BX	\$73.64/bx
7345827	4" X 4 yds, Deep Green,10/BX	\$91.09/bx
7345828	5" X 4 yds, Deep Green,10/BX	\$116.28/bx
7345865	2" X 4 yds, Yellow,10/BX	\$62.02/bx
7345867	4" X 4 yds, Yellow,10/BX	\$91.09/bx
7345850	2" X 4 yds, Mixed Pack,10/BX	\$62.02/bx
7345851	3" X 4 yds, Mixed Pack,10/BX	\$73.64/bx
7345852	4" X 4 yds, Mixed,10/BX	\$91.09/bx
7345832	4" X 4 yds, Deep Red,10/BX	\$91.09/bx
7345866	3" X 4 yds Yellow,10/BX	\$73.64/bx

Jorvet Dorsi-Flex Assist

BUY NOW



Provides light to moderate assistance for normal hind paw placement. Designed for use as a therapy aid or for daily activity. (Not to be used for dogs with severe neurological impairments.)

Uses:

- Reduces knuckling/standing on the dorsum of the paw
- Mobility aid for unstable or weak distal hind legs
- Assists with tarsal/hock flexion and digital extension
- Can be used bilaterally

Features:

- Adjustable, elastic tension straps
- Includes breathable, anti-skid, Thera-Paw boot
- Will not immobilize joints
- Lightweight
- Easy to put on/take off
- Cleans easily by rinsing with warm water



JOR1005	X Small Includes Thera-Paw size S/M #2 (paw 2.5"W x 3"L) and Tibial cuff up to 4.5" circumference	\$102.00/ea
JOR1005A	Small Includes Thera-Paw size M (paw 2.75"W x 3.5"L) and Tibial cuff up to 5.5" circumference	\$102.00/ea
JOR1005B	Medium Includes Thera-Paw size M/L #2 (paw 3"W x 3.75"L) and Tibial cuff up to 6.5" circumference	\$102.00/ea
JOR1005C	Large Includes Thera-Paw size L (paw 3.5"W x 4.25"L) and Tibial cuff up to 8" circumference	\$102.00/ea
JOR1005S	Kit of 4 sizes	\$392.00/ea

We do not stock all Orthopedic Products. Note that Jorvet/Jorgensen brand Products have a \$10 Dropship fee, as well as extra overnight fees.

13822 WEST BOULTON BLVD. METAWA, IL 60045

Phone 800-544-7521

231

WWW.SHOPMEDVET.COM

Fax 800-204-2177

Gel Cast & Splints



Jorvet Gel Cast

BUY NOW

This pink soft cast or bandage is useful for the management of soft tissue sprains or lower leg edema. The cast is actually a bandage material that is 100 percent cotton gauze evenly impregnated with a non-hardening zinc oxide paste. Considered a primary dressing that should be covered with a secondary bandage. Rolled and packaged in individual vacuum sealed pouches. Features and benefits:

- Contains zinc oxide paste to allow bandages to stay moist and comfortable, encouraging ambulation
- Thread-locking edges that prevent unraveling
- Non-gelatin. Does not cake or harden, stays soft over an extended period of time
- No preservatives that may cause allergy or hypersensitivity
- Vacuum sealed pouch prolongs shelf life.

JOR880	3" x 10 yds.	\$7.50/ea
JOR880A	4" x 10 yds.	\$8.10/ea

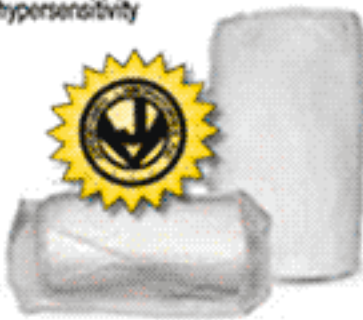

Splint Rod Bender with Splint Rods

Ideal for veterinarians who wish to save money by making their own splints. 24 per case.

JOR261A	3/16" X 6" 24/cs	\$150.00/cs
JOR261B	1/4" X 6" 24/cs	\$144.00/cs
JOR261C	3/8" X 6" 24/cs	\$186.00/cs
JOR261SB	Rod Bender only	\$93.00/ea



BUY NOW

Sam Splints

BUY NOW

The Sam® Splint is a closed-pore, foamed, coated, malleable aluminum product that is so unique it is patented. This lightweight radiolucent immobilization device, well-accepted in the human field, has been carefully evaluated and improved to meet the unique requirements of veterinary medicine. The Sam® Splint is the lightweight, universal veterinary splint.

- Washable, not affected by water, disinfectants or temperature extremes.
- Compact. May be stored flat or rolled.
- Easily cut with ordinary scissors.
- Radiolucent.

JOR289	4.25" X 36", Roll	\$18.90/rl
JOR289P	10/PK, 4.25" x 2"	\$31.50/pk



Jorvet Quick Splints (Pair)

BUY NOW

The latest design in pre-formed splints for small animal use, this splint is made of high impact ABS plastic and is scored for individual sizing. Radiolucent. Excellent replacement for Thomas Schroeder splints. All splints come in a paired left and right leg set. REAR LEG OR TARSAL SPLINT Shaped to follow the hock contour.

JOR119X	Cats and Small Dogs, Front, Left & Right, 12" Pr.	\$14.15/pr
JOR119Y	Medium Dogs, Front, Left & Right, 16" pr.	\$16.20/pr
JOR119Z	Large Dogs, Front, Left & Right, 20" pr	\$19.80/pr
JOR1190	Cats and Small Dogs, Rear, Left & Right, 9" pr.	\$11.40/pr
JOR119R	Medium Dogs, Rear, Left & Right, 12" pr.	\$14.00/pr
JOR119S	Large Dogs, Rear, Left & Right, 16" pr.	\$16.20/pr

Jorvet Quick Splint (4 Pack)

JOR1190L	Small, Front, Left, 4 pk	\$29.40/pk
JOR1190R	Small, Front, Right, 4 pk	\$29.40/pk
JOR119YL	Medium, Front, Left, 4 pk	\$34.50/pk
JOR119YR	Medium, Front, Right, 4 pk	\$34.50/pk
JOR119ZL	Large, Front, Left, 4 pk	\$42.30/pk
JOR119ZR	Large, Front, Right, 4 pk	\$42.30/pk
JOR1190L	Small, Rear Left, 4 pk	\$24.30/pk
JOR1190R	Small, Rear Right, 4 pk	\$24.30/pk
JOR119SL	Large, Rear, Left, 4 pk	\$39.00/pk
JOR119SR	Large, Rear Right, 4 pk	\$39.00/pk



Jorvet Carpal Splints

BUY NOW

These splints are made from a heavier material that is reinforced with longitudinal ribs. A recessed area reduces pressure on a carpal pad. A slight bend in the distal end follows the natural resting position. Splints are provided with an open pore foam for comfort.

JOR650A	Toy, 7.5" X 1" X 5/8"D	\$9.60/ea
JOR650B	Small, 10" X 1-1/4" X 5/8"D	\$10.50/ea
JOR650C	Medium, 12" X 1-1/2" X 7/8"D	\$10.65/ea
JOR650D	Large, 15" X 1-7/8" X 7/8"D	\$12.30/ea
JOR650E	XL, 18" X 2" X 1"D	\$16.20/ea
JOR650S	Set Of 5	\$57.00/ea



Jorvet Plastic Splints

Made of strong, light-weight plastic and padded with non-irritating foam. Can be contoured at distal end with addition of moderate heat; modified cutout for carpal pad. Radiolucent- will not interfere with X-ray while in place. Familiar green color.

BUY NOW

JOR119A	Small 1" x 8"	\$2.10/ea
JOR119B	Medium 1.5" X 12"	\$2.40/ea
JOR119C	Large 2" X 16"	\$3.15/ea



We do not stock all Orthopedic Products. Note that Jorvet/Jorgensen brand Products have a \$10 Dropship fee, as well as extra overnight fees.

13822 WEST BOULTON BLVD. METAWA, IL 60045

WWW.SHOPMEDVET.COM

Phone 800-544-7521

Fax 800-204-2177



Jorvet Adjustable Splints

BUY NOW

These pre-formed "T" splints offer adjustments over a wide range of sizes. Size adjustable by a simple set screw. The bottom or distal portion of the splint is stainless steel and the upper portion is malleable aluminum. It can be bent or angled for proper fitting. The proper sizing consists of the upper circle diameter, which is not adjustable, and a lower portion, which is adjustable over a maximum or minimum length.

JOR657	Front Leg Small	\$75.00/ea
JOR657A	Front Leg Medium	\$73.00/ea
JOR657B	Front Leg Lrg	\$87.00/ea
JOR657Q	Rear Leg X-S	\$72.00/ea
JOR657R	Rear Leg Small	\$73.00/ea
JOR657S	Rear Leg Medium	\$84.00/ea
JOR657T	Rear Leg Lrg	\$84.00/ea

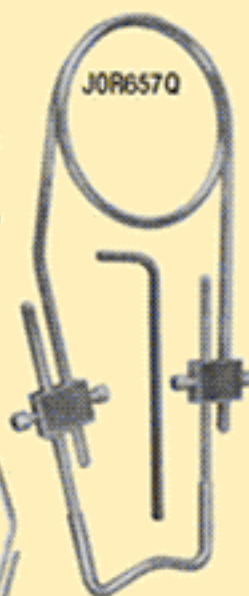

Petite Splint

BUY NOW

This very small splint is a malleable aluminum with blue 1/4" thick foam padding. The distal tip has a slight bend to give the spoon shape. Can be trimmed to shape. 1.5cm x 11cm. 3 per package.

JOR668P	1.5cm Wx11cm, 3/Pk	\$12.90/pk
---------	--------------------	------------



Jorvet Tail Splint

A four-finger malleable aluminum splint with blue foam padding. This splint fits over the end of the tail and is taped in place. 2" length. 3 per package.

JOR668	Aluminum 3/Pk	\$13.50/pk
--------	---------------	------------

BUY NOW

Hema Stop Styptic Powder

JOR1077	Small "pill vial" size. 14gm 0.5oz	\$4.50/ea
JOR1077A	Large screw cap vial. 1.5	\$9.00/ea



Jorvet Mason-Meta Splint

These are the original lightweight aluminum splints for lower limb injuries. These splints may be used with an extension, if a slightly longer splint is needed. These splints are reusable and designed to last.

BUY NOW



JOR651A	Toy, 1"W, 3 1/4"L	\$5.50/ea
JOR651B	Toy, 1"W, 5 1/4"L	\$6.00/ea
JOR651BX	Toy Ext, 1"W, 3 1/4"L	\$6.90/ea
JOR651C	Small, 1 1/4"W, 5"L	\$6.00/ea
JOR651D	Small, 1 1/4"W, 7"L	\$6.75/ea
JOR651DX	Sm Extension Ea, 1 1/4"W, 4"L	\$10.20/ea
JOR651E	Medium, 2"W, 7 1/2"L	\$6.90/ea
JOR651F	Medium, 2"W, 12"L	\$7.50/ea
JOR651FX	Med Extension Ea, 2"W, 6 1/4"L	\$10.20/ea
JOR651G	Large, 2 1/2"W, 14"L	\$7.80/ea
JOR651GX	Lg Extension Ea, 2 1/2"W, 7 1/4"L	\$10.20/ea
JOR651H	X-Large, 3"W, 16"L	\$9.00/ea
JOR651HX	X-L Extension Ea, 3"W, 7 1/4"L	\$9.30/ea
JOR651S	Splints Only-Set of 8, No extensions	\$48.00/ea
JOR651X	Set With Extension	\$90.00/ea

Mason meta-splints (4-wing nut set)

JOR651W	\$4.50	BUY NOW
---------	--------	----------------

SAVE ON PET MED SUPPLIES
SHOPMEDVET.COM

SUTURE
 Skin Staples/Tissue Adhesives

PHARMACEUTICALS
 Ophthalmics/Antibiotics/Vaccines

INSTRUMENTS
 Sphygmomanometers/Gauges

GLOVES
 Exam/Surgical/Animal Handling

COTTON/GAUZE
 Sponges/Brown/Roll

GOWNS
 Surgical/Barrier/Patient



We do not stock all Orthopedic Products. Note that Jorvet/Jorgensen brand Products have a \$10 Dropship fee, as well as extra overnight fees.

13822 WEST BOULTON BLVD. METAWA, IL 60045

WWW.SHOPMEDVET.COM

Phone 800-544-7521

288

Fax 800-204-2177

Marq-Easy Thermo Plastic Splints



Jorevet Marq-Easy Thermoplastic Splint Sheets

Solid construction 1/8" thick splint sheets offers superior rigidity and tensile strength (180,000 psi), making it ideal for weight-bearing splints in small and large animals (i.e., medium to large dogs, horses, and livestock). The tough, rubberbased material makes a strong, rigid splint, drapes well over contours and bony areas, and adheres to itself when heated to reinforce or patch splint. Radiolucent. Tan.

JOR940A	4" x 9". For narrow, long legs	\$12.00/ea
JOR940B	6" x 12" Sheet	\$22.50/ea
JOR940C	12" x 24" Sheet	\$75.00/ea
JOR940F	4" x 6" Sheet	\$9.90/ea
JOR940G	6" x 9" Sheet	\$20.70/ea
JOR940H	9" x 12" Sheet	\$34.35/ea
JOR940V	Kit includes: 1" x 36"L strap and 12" hook patch with self-adhesive back side. Both can be trimmed to customize the splint.	\$8.60ea

BUY NOW

Marq-Easy Thermoplastic Splint Sheets Kit

Provides all the basic components to get started with thermoplastic splinting. A wide range of applications can be accomplished with the materials provided along with the comprehensive CD R Kit includes:

- JOR940b Marq Easy 1/8" Thick Splint Sheet. 6" x 12".
- JOR940g Marq Easy 1/16" Thin Splint Sheet. 6" x 9".
- JOR940w Polycushion 1/8" Thick Padding. 18" x 24".
- JOR940x Compact Foam 3/8" Thick Padding. 16" x 24".
- JOR940s Clear Thera-Gel 1/8" Thick Sheet.
- JOR940v Soft Padded Velcro Strapping. 1"W.
- JOR940t Soft Padded Velcro Strapping. 2"W.
- JOR940cd Instructional CD ROM.
- JOR291bc Cotton Stocknette 2" x 25 yd. (also in kit)

JOR940K Starter Kit \$138.00/ea

NEW



BUY NOW

Jorvet Clear Thera-Gel 1/8" Thick Sheet

With self-adhesive back. Cut to fit to protect bony prominences and sensitive areas. Contains mineral oil to help soften and protect delicate skin. Washable with soap and water.

BUY NOW

JOR940S Latex-free, 4" x 4" \$24.60/ea

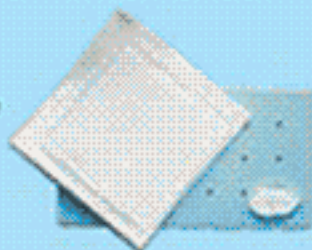

Jorvet Polycushion 1/8" Thick Padding

Self-adhesive back. Closed-cell, soft construction. Adheres to splint sheet prior to heating in water. Applying this padding on splint sheet prior to heating in water takes longer to soften (~5 minutes). For all-purpose use. Wipes clean with damp cloth.

JOR940W Latex-free. Tan. 17 3/4" x 24" \$21.00/ea

BUY NOW



Jorvet Compact Blue Foam

With self-adhesive back. Open-cell, slow-recovery construction. Medium-density, compact foam molds with body heat to contour body parts. Use to pad the splint for increased patient comfort. Contains some latex.

BUY NOW

JOR940X 3/8" Thick Padding (for Splints), 16" x 24" sheet \$36.50/ea



Jorvet Soft Padded Velcro Strapping

Velcro Strapping useful for larger animals or to disperse pressure over larger surface areas. Kit includes: 2" x 36"L strap and 12" hook patch with self-adhesive back side. Both can be trimmed or thinned as needed.

JOR940T 2" x 1 yd \$12.90/set

BUY NOW



Jorvet Halpa Fleece Liner

With self-adhesive back. Open-cell, extremely softweave. Mild stretch makes it easier to line intricate spaces and contours for use with smaller animals, including small dogs, cats, birds, and exotics. Useful to pad strapping material and for covering minor creases in splints.

BUY NOW

JOR940Y Latex-free 100% cotton. Pink. 9" x 16" \$18.75/ea



We do not stock all Orthopedic Products. Note that Jorvet/Jorgensen brand Products have a \$10 Dropship fee, as well as extra overnight fees.

13822 WEST BOULTON BLVD. METTAWA, IL 60045

WWW.SHOPMEDVET.COM

Phone 800-544-7521

234

Fax 800-204-2177

Vet-Lite, Carpo Wraps & Carpo-Splints



Vet-lite Sheet

BUY NOW

This product was a popular product that was discontinued a few years ago in the veterinary field. It is now available once again. Constructed of thermoplastic white mesh. When heated in hot water, it turns into a soft malleable material that can be shaped into any configuration. Hardens as it cools.

- Can be reheated and reshaped
- Partially used material may be retained for future use
- Waterproof
- Gloves not required
- Long shelf life

JOR758SA	3"W x 15"L. 15 sheets/pk	\$51.00/pk
JOR758SB	4"W x 15"L. 15 sheets/pk	\$60.00/pk
JOR758SC	6"W x 15"L. 15 sheets/pk	\$87.00/pk

Vet-lite Cast Material

BUY NOW

Vet-lite

This product was a popular product that was discontinued a few years ago in the veterinary field. It is now available once again. Constructed of thermoplastic white mesh. When heated in hot water, it turns into a soft malleable material that can be shaped into any configuration. Hardens as it cools.

- Can be reheated and reshaped
- Partially used material may be retained for future use
- Waterproof
- Gloves not required
- Long shelf life

JOR758A	2"W x 70"L. 10 rolls/box	\$99.00/pk
JOR758B	3"W x 70"L. 10 rolls/box	\$128.00/pk
JOR758C	4"W x 70"L. 10 rolls/box	\$162.00/pk
JOR758D	6"W x 70"L. 10 rolls/box	\$218.00/pk



Carpo-Flex Sportswraps Light

Jorvet

BUY NOW

Available in 3 carpal support products that vary in the degree of support that they provide. Degree of Support Scale (1-10): 1 (provides light support) - 10 (provides complete immobilization) 1) Carpo-Flex Sports Wrap: Provides light support and protection (Scale: 1 - 3). Ideal for mild strains and sprains.



JOR1004	XS right Teal. 5"W x 3.5"H; 1.0mm neoprene; 1"W elastic straps	\$29.00/ea
JOR1004A	Small, Right, Red. 6"W x 5"H; 1.5mm neoprene; 1"W and 1.5"W elastic straps	\$31.00/ea
JOR1004AL	Small, Left, (fits small to medium dogs with up to 5.5" wrist circumference)	\$31.00/ea
JOR1004B	Medium, Right, Blue. 7"W x 6"H; 1.5mm neoprene; 1.5"W elastic straps	\$32.50/ea
JOR1004BL	Medium, Left, (fits medium dogs with up to 6.5" wrist circumference)	\$32.50/ea
JOR1004C	Large, Black, Right, 8"W x 6.75"H; 2.0mm neoprene; 2"W elastic straps	\$36.00/ea
JOR1004CL	Large, Left, Black (fits large dogs with up to 7.5" wrist circumference)	\$36.00/ea

Carpo-Flex-X

BUY NOW

Jorvet

Provides moderate support (Scale: 4 - 7). Nylon support straps can be Velcroed on any aspect of the wrap for customized support of the medial, lateral, and/or caudal aspect of the limb.

JOR1004JL	X Large, Left	\$77.00/ea
JOR1004E	Xsmall, Right	\$62.00/ea
JOR1004EL	XSmall-Left	\$62.00/ea
JOR1004F	Small-Right	\$66.00/ea
JOR1004FL	Small-Left	\$66.00/ea
JOR1004G	Medium-Right	\$71.00/ea
JOR1004GL	Medium-Left	\$71.00/ea
JOR1004H	Large, Right	\$74.00/ea
JOR1004HL	Large, Left	\$74.00/ea
JOR1004L	(fits small to medium dogs with up to 5.5" wrist circumference)	\$25.00/ea
JOR1004J	X Large, Right	\$77.00/ea



GO TO WWW.SHOPMEDVET.COM FOR CLOSEOUTS UP TO 80% OFF!

Jorvet Carpo-Splint Kit

BUY NOW

Provides heavy support to complete immobilization (Scale: 8 - 10). Thermoplastic sheet can be molded over any aspect of the wrap to produce a custom immobilizing splint. The Kit includes 1 thick, neoprene wrap, foam padding, nylon straps, thermoplastic sheet, and Velcro tabs.

JOR1004M	X Small-right	\$77.00/ea
JOR1004ML	X Small-left	\$77.00/ea
JOR1004N	Small-right	\$81.00/ea
JOR1004NL	Small-Left	\$81.00/ea
JOR1004P	Medium-right	\$85.00/ea
JOR1004PL	Medium-Left	\$85.00/ea
JOR1004O	Large-Right	\$89.00/ea
JOR1004OL	Large-Left	\$89.00/ea
JOR1004R	X Large-Right	\$93.00/ea
JOR1004RL	X Large-Left	\$93.00/ea



We do not stock all Orthopedic Products. Note that Jorvet/Jorgensen brand Products have a \$10 Dropship fee, as well as extra overnight fees.

13822 WEST BOULTON BLVD. METAWA, IL 60045

Phone 800-544-7521

235

WWW.SHOPMEDVET.COM

Fax 800-204-2177



DogLeggs Chest Strap

The Chest Strap holds DogLeggs in the correct position over the dog's shoulders. Not all dogs need one, however, many do. A chest strap is part of the purchase of each pair of DogLeggs. Due to the variety of dogs each pair of DogLeggs fits, sizing is determined at the time of purchase.

JOR746AS	Small, 16"	\$16.50/ea
JOR746BS	Medium, 18"	\$16.50/ea
JOR746CS	Medium-Large 20"	\$16.50/ea
JOR746DS	Large, 22"	\$16.50/ea
JOR746ES	X-large, 24"	\$13.50/ea

Limited Supply While Supplies Last!



BUY NOW



Jorvet Orthopedic Surgical Pack

This Orthopedic Surgical Pack provides every piece of surgical instrumentation to get started with orthopedic procedures with an emphasis on IM pins and cerclage wires.

Includes:

- JOR214L Jacob's Hand Chuck.
- JOR250 IM Bone Pin Bag.
- JOR250n K-Wires (6).
- JOR250p K-Wires (6).
- JOR228b Osteotome.
- JOR107 Gigli Wire.
- JOR107h Gigli Wire Handles (2).
- JOR222 Bone Curette #0.
- JOR243 Serr Retractors (2).
- JOR241 Weifaner Retractor.
- JOR159L Kern's Bone Holding Clamp.
- JOR159 Mini Kern's Bone Holding Clamp.
- JOR218 Cerclage Wire Twister and Cutter.
- JOR260b Cerclage Wire. 20g x 10mm.
- JOR260c Cerclage Wire. 22g x 10mm.
- JOR209f Forman Bone Rasp.
- JOR220ba Pin Cutter
- JOR226q Freer Elevator.
- JOR224f Friedman Rongeur.
- JOR251b Part Threads Bone Pin. 5.64" (2).
- JOR251c Part Threads Bone Pin. 3.32" (2).
- JOR251d Part Threads Bone Pin. 7.64" (2).
- JOR251e Part Threads Bone Pin. 1.8" (2).
- JOR251f Part Threads IM Pin. 9.64" (2).
- JOR251a Part Threads IM Pin. 1.16" (2).
- JOR228m Gerzog Mallet.

JOR427 Complete Pack \$1,068.00/ea

BUY NOW



We do not stock all Orthopedic Products. Note that Jorvet/Jorgensen brand Products have a \$10 Dropship fee, as well as extra overnight fees.



Jorvet External Fixation Starter Kit

BUY NOW

Basic kit to provide components enough for any type I frame in small and medium size. Ideal for beginning entry into external fixation.

JOR371K	Complete Kit	\$465.00/ea
JOR371S	Single Fixation Clamp, Small	\$30.00/ea
JOR371M	Single Fixation Clamp, Medium	\$25.50/ea
JOR371DS	Double Fixation Clamp, Small	\$54.00/ea
JOR371DM	Double Fixation Clamp, Medium	\$61.00/ea
JOR371PA	3/32" External fixation pins (4) pt. thrd.	\$16.20/ea
JOR371PB	1/8" External fixation pins (4) pt. thrd.	\$9.75/ea

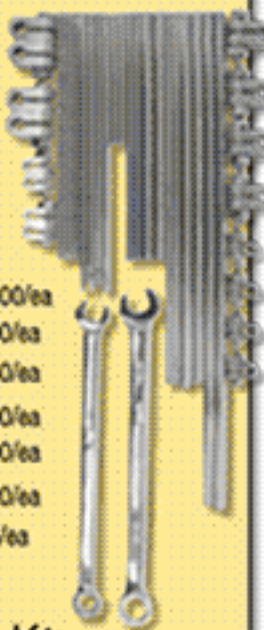

Jorvet Small Fixation Type I Kit

The pins of Type-I frame pass through both bone cortices. The clamps and connecting rods are assembled only on one side of the injured leg. Type-I Kit contains:

- 6 Single clamps
- 2 External fixation part thread pins
- 2 Double trocar smooth IM pins
- 1 Connecting rod

JOR371KS	Small, Pin, 3/32" dia. Rod, 6"L	\$155.00/ea
JOR371KL	Large, Pin, 5/32" dia. Rod, 10"L	\$154.00/ea

NEW

BUY NOW

Type-II External Fixation Kit



The pins of the Type-II configuration pass through two sides of the limb. Clamps are attached to both ends of protruding pins. Type-II kit contains:

- 4 Double trocar IM pins
- 8 Single clamps
- 2 Connecting bars

JOR371KBL	Large, IM pin, 5/32" x 10" Rod, 10"L	\$216.00/ea
JOR371KBM	Medium, IM pin, 1/8" x 9" Rod, 8"L	\$199.00/ea
JOR371KBS	Small, IM pin, 3/32" x 8" Rod, 6"L	\$211.00/ea

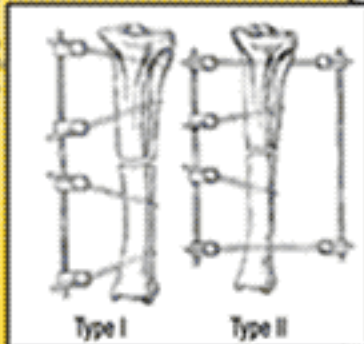

Jorvet Extra-Large or Equine KE

BUY NOW

Oversized KE clamps takes a full 1/4" pin.

JOR371XLD	Double KE Clamp, X-Large	\$140.00/ea
JOR371XLS	Single KE Clamp, X-Large	\$77.00/ea

Jorvet Connecting Rod

BUY NOW

A variety of sizes are offered to work with every case.

JOR371RMH	3/16" x 10" length	\$9.00/ea
-----------	--------------------	-----------



Jorvet Dynamic External Fixator Kit

New design allows KE device to do limb lengthening on a dynamic basis of 1mm per day. KE pins and threaded rods are the same sizes as standard KE parts. External Fixator Kit contains:

- 2 Threaded rods
- 4 Sliding double KE clamps
- 8 Locking nuts
- 2 Raised-center face pins
- 2 Trocar-trocar pins

JOR371DFL	Large	\$640.00/ea
JOR371DFM	Medium	\$505.00/ea
JOR371DFS	Small	\$600.00/ea



BUY NOW

Jorvet Connecting Rods

BUY NOW

JOR371RXL	100mm L, 5/16" diameter	\$32.00/ea
JOR371RXLB	200mm L, 5/16" diameter	\$42.00/ea
JOR371RXL	300mm L, 5/16" diameter	\$52.50/ea
JOR371RXL	400mm L, 5/16" diameter	\$72.00/ea



BUY NOW



Jorvet KE Starter Kit with raised (positive) Threaded Pins

BUY NOW

JOR371XB	Medium Pin Kit. JOR371m 8 Medium Single Clamps. JOR371g 4 Positive Profile End-Threaded, medium. JOR371b 4 Positive Profile Mid-Threaded, medium. JOR371rmg 2 Connecting Bars, 8"L. JOR372d Drill Bit, 7/64".	\$279.00/ea
----------	--	-------------

JOR371XA	Small Pin Kit. JOR371s 8 Small Single Clamps. JOR371f 4 Positive Profile End-Threaded, small. JOR371a 4 Positive Profile Mid-Threaded, small. JOR371rsf 2 Connecting Bars, 6"L. JOR372b Drill Bit, 5/64".	\$316.00/ea
----------	--	-------------

Jorvet Type-I Half Pin

BUY NOW

Partially threaded pins engage the cortex and increase the pull out resistance.

JOR371PC	5/32" x 5"	\$9.75/ea
----------	------------	-----------



We do not stock all Orthopedic Products. Note that Jorvet/Jorgensen brand Products have a \$10 Dropship fee, as well as extra overnight fees.

13822 WEST BOUTON BLVD. METAWA, IL 60045

WWW.SHOPMEDVET.COM

Phone 800-544-7521

Fax 800-204-2177



Jorvet Dynamic External Fixator Parts. Threaded Rods

BUY NOW

JOR371TLA	Large, 100mm.	\$36.00/ea
JOR371TLB	Large, 200mm.	\$48.00/ea
JOR371TMA	Medium, 75mm.	\$36.00/ea
JOR371TMB	Medium, 150mm.	\$48.00/ea
JOR371TMC	Medium, 200mm.	\$45.00/ea
JOR371TSA	Small, 100mm.	\$21.00/ea
JOR371TSB	Small, 100mm	\$30.00/ea

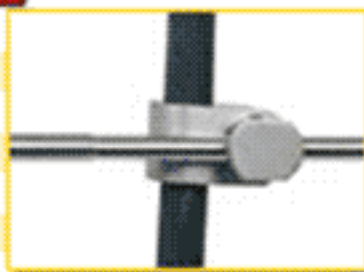

Jorvet Dynamic External Fixator Parts Compatible with System

New design allows KE device to do limb lengthening on a dynamic basis of 1mm per day. KE pins and threaded rods are the same sizes as standard KE parts. External Fixator Kit contains:

- 2 Threaded rods
- 4 Sliding double KE clamps
- 8 Locking nuts
- 2 Raised-center face pins
- 2 Trocar-trocar pins

BUY NOW



Jorvet External Fixation Clamps

All fixators are high grade surgical stainless steel and will interchange with other brands of fixators. New aesthetic design combined with a lower cost makes Jorvet external fixation equipment the best value.

BUY NOW

JOR371DL	Double Fixation Clamp. Large	\$47.00/ea
JOR371DM	Double Fixation Clamp. Medium	\$61.00/ea
JOR371L	Single Fixation Clamp. Large	\$33.00/ea
JOR371M	Single Fixation Clamp. Medium	\$25.50/ea
JOR371S	Single Fixation Clamp. Small	\$30.00/ea

JOR371DLC	Sliding Double KE Clamp. Large	\$108.00/ea
JOR371DMC	Sliding Double KE Clamp. Medium	\$96.00/ea
JOR371DMS	Sliding Single KE Clamp. Medium	\$46.50/ea
JOR371DSS	Sliding Single KE Clamp. Small	\$45.00/ea
JOR371KAL	KE Knurled Adjustor. Large.	\$28.50/ea
JOR371KAM	KE Knurled Adjustor. Medium.	\$25.50/ea
JOR371KAS	KE Knurled Adjustor. Small	\$25.50/ea
JOR371LL	KE Locking Nut. Large.	\$5.10/ea
JOR371LM	KE Locking Nut. Medium.	\$4.50/ea
JOR371LS	KE Locking Nut. Small.	\$4.50/ea

Jorvet External Fixation Rods

Small 1/8" D

JOR371RSA	Small Rod 1/8 D, 1 1/2" L	\$6.00/ea
JOR371RSB	Small Rod 1/8 D, 2" L	\$9.00/ea
JOR371RSD	Small Rod 1/8 D, 4" L	\$9.60/ea
JOR371RSF	Small Rod 1/8 D, 6" L	\$15.75/ea

Medium 3/16" D

JOR371RMA	Medium Rods, 3/16" D, 2" L	\$6.00/ea
JOR371RMC	Medium Rods, 3/16" D, 4" L	\$8.40/ea
JOR371RME	Medium Rods, 3/16" D, 6" L	\$8.70/ea
JOR371RMG	Medium Rods, 3/16" D, 8" L	\$18.00/ea

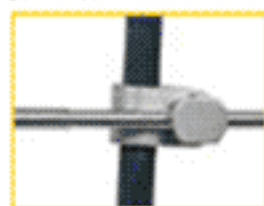

BUY NOW

Jorvet

Jorvet Medium Fixation Type I Kit

The pins of Type-I frame pass through both bone cortices. The clamps and connecting rods are assembled only on one side of the injured leg.

- Type-I Kit contains:
- 6 Single clamps
 - 2 External fixation part thread pins
 - 2 Double trocar smooth IM pins
 - 1 Connecting rod



BUY NOW

JOR371KM	Medium. Pin, 1/8" dia. Rod, 8" L.	\$144.00/ea
----------	-----------------------------------	-------------

Large 5/16" D

JOR371RLA	Large Rods 5/16" D, 4" L	\$7.50/ea
JOR371RLB	Large Rods 5/16" D, 6" L	\$7.50/ea
JOR371RLC	Large Rods 5/16" D, 8" L	\$13.50/ea
JOR371RLD	Large Rods 5/16" D, 10" L	\$12.00/ea
JOR371RLE	Large Rods 5/16" D, 12" L	\$9.00/ea

BUY NOW

Jorvet Carbon Fiber ESF Bars

Carbon fiber ESF bars offer two advantages over conventional stainless. They are radiolucent and lighter in weight but comparable in strength. Note: carbon fiber needs to cut with a saw versus stainless pin cutters.

Medium 3/16" D

JOR371RMAC	Medium Bars 3/16" D, 2" L	\$7.50/ea
------------	---------------------------	-----------

Large 5/16" D

JOR371RLAC	Large Bars 5/16" D, 5/16" W x 4" L	\$10.20/ea
JOR371RLBC	Large Bars 5/16" D, 5/15" W x 6" L	\$15.00/ea



Jorvet Mid-shaft Positive (Raised) Threaded External Fixation Pins

Positive or raised thread pins have threads extending above the smooth shaft on a portion of the pin. The positive threaded pins have a tougher pull-out resistance and are the external fixation pins used almost exclusively in human orthopedics. There are two choices of pin styles and three different sizes.

1. Threaded portion is in mid-shaft
 2. Threaded portion is at the end of the pin
- All pins are 316LVM implant quality stainless steel.

BUY NOW

JOR371A	Small. Shaft 3/32" dia., Thread 1/8" dia., Thread Part 3/4" L, Total 4" L, Thread Pitch 0.9mm	\$18.00/ea
JOR371B	Medium. Shaft 1/8" dia., Thread 5/32" dia., Thread Part 11/4" L, Total 5" L, Thread Pitch 0.9mm	\$18.60/ea
JOR371C	Large. Shaft 5/32" dia., Thread 3/16" dia., Thread Part 11/2" L, Total 6" L, Thread Pitch 0.9mm	\$18.60/ea

Jorvet Fixation Clamp

BUY NOW

JOR371SH	Hinged, Small	\$93.00/ea
JOR371LH	Hinged, Large	\$96.00/ea
JOR371MH	Hinged Medium	\$94.00/ea



We do not stock all Orthopedic Products. Note that Jorvet/Jorgensen brand Products have a \$10 Dropship fee, as well as extra overnight fees.



JORVET Small Linear Fixator Kit

Jorvet Small Linear Fixator Kit

- 4 each (total of 8) of 2.5mm (JOR1075d1) and 4mm (JOR1075d2) variant clamps
- 1 each size carbon rods lengths (4) J-1075ca, cb, cc, cd
- stainless steel container (JOR1075sc)
- J-1075wa, 7mm wrench
- 6 small linear fixator pins (JOR1075c series)

BUY NOW



JOR1075 \$410.00/ea

Small Linear Fixator Pin

JOR1075CM	80mm x 4mm x 4mm	\$8.10/ea
JOR1075CN	80mm x 4mm x 3mm	\$8.10/ea
JOR1075CP	80mm x 2.5mm x 2.5mm	\$8.10/ea
JOR1075CR	60mm x 2.5mm x 2.5mm	\$8.10/ea
JOR1075CS	50mm x 2.5mm x 2.5mm	\$8.10/ea
JOR1075CT	50mm x 2.5mm x 1.5mm	\$8.10/ea

Small Linear Hook on Clamp

All parts available individually

BUY NOW

JOR1075D1	uses 1.5mm-2.5mm pins	\$20.00/ea
JOR1075D2	uses 3mm-4mm pins	\$20.00/ea

Jorvet Small Linear Fixator

BUY NOW

JOR1075CA	Carbon rod, 4mm x 75mm	\$8.00/ea
JOR1075CB	Carbon rod, 4mm x 100mm	\$10.00/ea
JOR1075CC	Carbon rod, 4mm x 150mm	\$12.00/ea
JOR1075CD	Carbon rod, 4mm x 200mm	\$14.00/ea
JOR1075CE	Carbon fibre bar 11mm x 150mm	\$28.00/ea
JOR1075CF	Carbon fibre bar, 11mm x 200mm	\$32.00/ea
JOR1075CG	Carbon fibre bar 11mm x 250mm	\$35.00/ea
JOR1075CJ	Carbon fibre bar, 11mm X 350mm	\$42.00/ea

Wrench

BUY NOW

JOR1075WB	11mm	\$12.90/ea
JOR1075WC	11mm Box Wrench	\$42.00/ea
JOR1075WA	7mm	\$12.90/ea

Linear Fixation Container Jorvet

JOR1075SC \$290.00/ea **BUY NOW**

Large Linear Fixator System Jorvet

JOR1075LLK \$881.00/ea **BUY NOW**

Jorvet

2.7mm Cortical Self Tapping Screws

BUY NOW

JOR1072AT	6mm 2.0mm, Titanium	\$27.50/ea	JOR1072GT	18mm 2.0mm, Titanium	\$29.25/ea
JOR1072BT	Titanium, 8mm 2.0mm	\$27.50/ea	JOR1072HT	20mm 2.0mm, Titanium	\$29.25/ea
JOR1072CT	10mm 2.0mm, Titanium	\$27.75/ea	JOR1072IT	22mm 2.0mm	\$30.00/ea
JOR1072DT	12mm 2.0mm, Titanium	\$27.75/ea	JOR1072JT	24mm 2.0mm, Titanium	\$30.00/ea
JOR1072ET	14mm 2.0mm, Titanium	\$28.50/ea	JOR1072KT	26mm 2.0mm, Titanium	\$30.75/ea
JOR1072FT	16mm 2.0mm, Titanium	\$28.50/ea	JOR1072LT	28mm 2.0mm, Titanium	\$33.00/ea

BUY NOW

Jorvet 3.5mm Cortical Self Tapping Screws

JOR1074AT	16mm 2.5mm, Titanium	\$27.00/ea	JOR1074ET	24mm 2.5mm, Titanium	\$29.25/ea
JOR1074BT	18mm 2.5mm, Titanium	\$27.00/ea	JOR1074FT	26mm 2.5mm, Titanium	\$29.25/ea
JOR1074CT	20mm 2.5mm, Titanium	\$27.00/ea	JOR1074GT	28mm 2.5mm, Titanium	\$30.00/ea
JOR1074DT	22mm 2.5mm, Titanium	\$27.00/ea	JOR1074HT	30mm 2.5mm, Titanium	\$30.00/ea

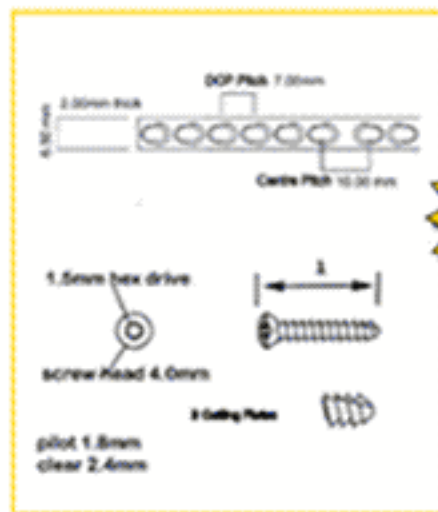

Cancellous Screw, Fully-Threaded, Self-Tapping, 4.0 mm

Jorvet

4mm Cancellous Screw, Full Thread. Use as cancellous screws where greater screw-bone interface is desirable. 6/pk.

BUY NOW

JOR424AS	10mm L	\$9.00/ea	JOR424HS	24mm L	\$10.50/ea
JOR424BS	12mm L	\$10.50/ea	JOR424IS	26mm L	\$15.00/ea
JOR424DS	16mm L	\$9.00/ea	JOR424JS	28mm L	\$15.00/ea
JOR424ES	18mm L	\$10.50/ea	JOR424KS	30mm L	\$15.00/ea
JOR424FS	20mm L	\$10.50/ea	JOR424LS	35mm L	\$15.00/ea
JOR424GS	22mm L	\$10.50/ea	JOR424MS	40mm L	\$15.00/ea
			JOR424NS	45mm L	\$15.75/ea

- BUY 1 GET 1 FREE SPECIALS!
- CLOSEOUTS @ DEEP DISCOUNTS!
- LOYAL CUSTOMERS SPECIALS!

Connect with us @:

facebook.com/medvetinternational

@SHOPMEDVET twitter



We do not stock all Orthopedic Products. Note that Jorvet/Jorgensen brand Products have a \$10 Dropship fee, as well as extra overnight fees.

13822 WEST BOULTON BLVD. METAWA, IL 60045

WWW.SHOPMEDVET.COM

Phone 800-544-7521

239

Fax 800-204-2177



External Fixation Kits & IM Pins

Jorvet Trocar-Trocar I. M. Pin **BUY NOW**

Highest quality type 316L stainless steel IM pins. Available in the points and diameters listed below. When ordering, please match diameter with point style number. Made in U.S.A.

JOR250I	1/4" x 12"	\$12.60/ea
JOR250H	3/16" x 12"	\$10.20/ea



Jorvet IM Pin Starter Kit **BUY NOW**

IM pin starter kit comes with autoclavable pin bag. Please specify IM pin style desired. Kits include:

- 0.9mm — (.035") k-wire 6 ea.
- 1.1mm — (.045") k-wire 6 ea.
- 1.6mm — (.062") k-wire 6 ea.
- 1.6mm — 1/16" IM pin 2 ea.
- 2.0mm — 5/64" IM pin 2 ea.
- 2.3mm — 3/32" IM pin 2 ea.
- 2.6mm — 7/64" IM pin 2 ea.
- 3.0mm — 1/8" IM pin 2 ea.
- 3.4mm — 9/64" IM pin 2 ea.
- 3.8mm — 5/32" IM pin 2 ea.
- 4.5mm — 3/16" IM pin 2 ea.
- 6.0mm — 1/4" IM pin 2 ea.



Trocar-Trocar **\$165⁰⁰/ea**
Trocar-Screw **\$200⁰⁰/ea**

JOR250K	Trocar-Trocar Pin Starter Kit, kit with autoclavable pin bag	\$165.00/ea
JOR250L	Trocar-Screw Starter Kit, kit with autoclavable pin bag	\$200.00/ea



Jorvet IM Pin Deluxe Kit

IM pin Deluxe Kit comes with autoclavable pin bag.

- 0.9mm — (.035") k-wire 6 ea.
- 1.1mm — (.045") k-wire 6 ea.
- 1.6mm — (.062") k-wire 6 ea.
- 1.6mm — 1/16" IM pin 4 ea.
- 2.0mm — 5/64" IM pin 4 ea.
- 2.3mm — 3/32" IM pin 6 ea.
- 2.6mm — 7/64" IM pin 6 ea.
- 3.0mm — 1/8" IM pin 6 ea.
- 3.4mm — 9/64" IM pin 6 ea.
- 3.8mm — 5/32" IM pin 6 ea.
- 4.5mm — 3/16" IM pin 4 ea.
- 6.0mm — 1/4" IM pin 4 ea.

BUY NOW
Jorvet

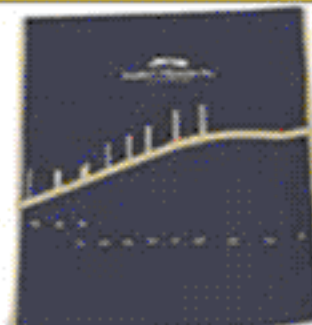

Trocar-Trocar **\$291⁰⁰/ea**
Trocar-Screw **\$330⁰⁰/ea**

JOR250LD	Trocar-Screw Pin Deluxe Kit	\$330.00/ea
JOR250KD	Trocar-Trocar Pin Deluxe Kit	\$291.00/ea

Jorvet Im Pin Bag

IM pin bag that allows IM pin organization in a neat and easy-to-find fashion.

JOR250 Autoclavable **BUY NOW**
\$20¹⁰/bg

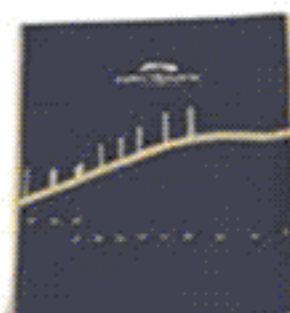

Jorvet Steinman Pin **BUY NOW**

Highest quality type 316L stainless steel IM pins. Available in the points and diameters listed below. When ordering, please match diameter with point style number. Made in U.S.A.

JOR251A	1/16" X 7" w/trocar-screw	\$5.25/ea
JOR251B	5/64" X 7", w/trocar-screw	\$5.55/ea
JOR251C	3/32 X 8, w/trocar-screw	\$7.20/ea
JOR251D	7/64 X 8, w/trocar-screw	\$7.20/ea
JOR251E	1/8" x 9", w/trocar-screw	\$6.45/ea
JOR251G	5/32" x 10", w/trocar-screw	\$9.00/ea
JOR251H	3/16" x 12", w/trocar-screw	\$10.65/ea
JOR251I	1/4" x 12", w/trocar-screw	\$11.10/ea



Round Trocar **BUY NOW**

Stainless steel with 10 plastic disposable cannulae. 5. shaft.

JOR40P	5. shaft.	\$94.00/ea
--------	-----------	------------



Equine Trocar/Cannula

Suggested use for cecum puncture.

JOR40EK	Very small 3mm dia. x 135mm (5.4") shaft	\$148.00/ea
---------	--	-------------

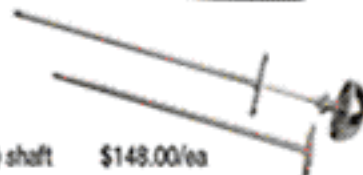

Corkscrew Trocar with Plastic Stylet

This is the self-retaining bloot trocar used in chronic bloats. Make a small 3/4" incision in hide. Screw the trocar into position. After insertion, the rumen should be pulled up close to the peritoneum by placing a few wraps of gauze between the trocar plate and hide.

BUY NOW

JOR40F	\$5.70/ea
--------	-----------



Jorvet Pin Cutter

- For cutting intramedullary pins and customizing bone plates
- Stainless steel. 1470g. 48cm(19"L).
- Cuts up to 6.4mm (1/4") pins.
- Narrow jaws allow extra-close pin cutting

BUY NOW

JOR220	19" L, Stainless Steel	\$295.00/ea
--------	------------------------	-------------



IM Bone Pin Protective Tube

Stores Bone Pins in an aluminum autoclavable round tube with a screw-on cap.

BUY NOW

JOR250X	320mm long x 30mm diameter	\$104.00/ea
JOR250Y	225mm long x 30mm diameter for "K" wires	\$104.00/ea



We do not stock all Orthopedic Products. Note that Jorvet/Jorgensen brand Products have a \$10 Dropship fee, as well as extra overnight fees.

13822 WEST BOULTON BLVD. METAWA, IL 60045

WWW.SHOPMEDVET.COM

Phone 800-544-7521

24/7

Fax 800-204-2177



Fessa Tubular Fixation System & Cortical Nut

Fessa Tubular Fixator System

This system is widely used in Europe and offers several advantages over conventional fixator systems. The connecting tubes or rods use a simple hexhead set screw as the pin holding or clamping mechanism. The system is very strong for its light weight. The smaller tubes will accept the smallest of K-wire making it extremely useful in fracture management of small exotics and cats.

JOR1050	6/7mm Starter Kit	\$520.00/ea
JOR1050A	6mm X 30mm long tube	\$42.00/ea
JOR1050B	6mm X 45mm long tube	\$45.00/ea
JOR1051B	8mm X 150mm tube	\$87.00/ea
JOR1051C	8mm X 200mm l tube	\$87.00/ea
JOR1051E	Locking Screws (10)- 8mm	\$21.00/ea
JOR1050C	6mm X 65mm long tube	\$60.00/ea
JOR1050D	Hexdriver Allen wrench - 6mm	\$21.00/ea
JOR1050E	Locking Screws (10) - 6mm	\$19.50/ea
JOR1050F	6mm hinge	\$60.00/ea
JOR1051A	8mm X 100mm tube	\$66.00/ea
JOR1051D	Hexdriver Allen wrench - 8mm	\$15.00/ea
JOR1051F	8mm hinge	\$81.00/ea

BUY NOW

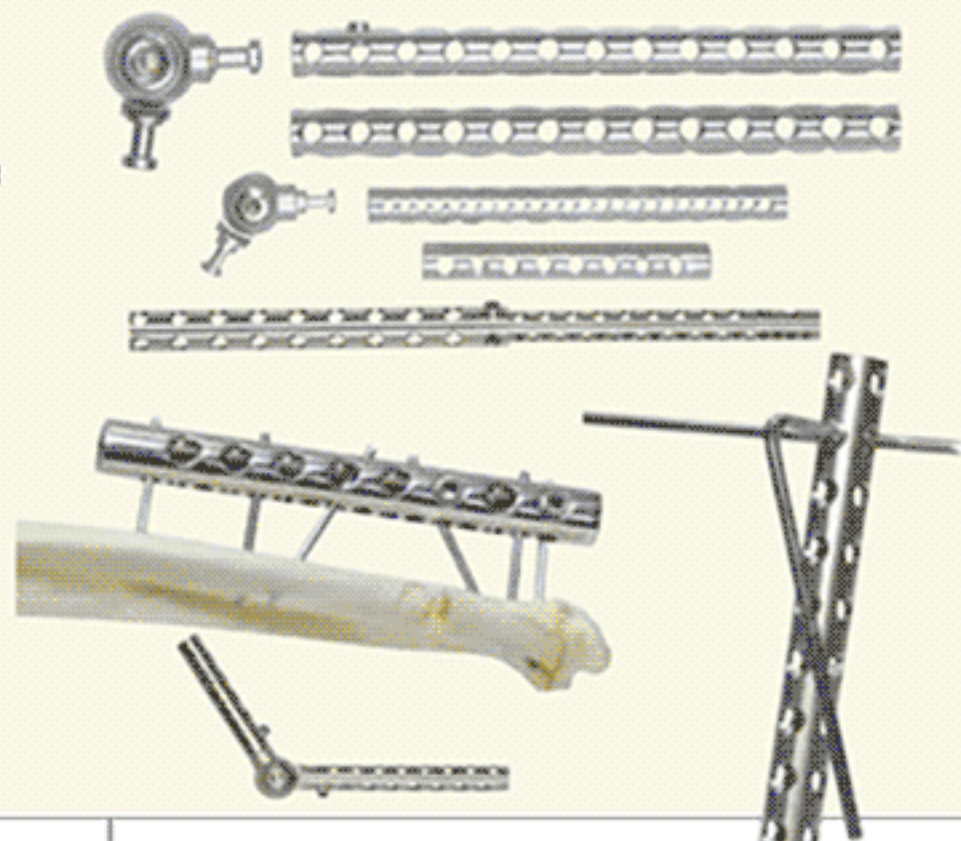

Jorvet Combination Drill Tap & Insert

JOR1072G	for 2.7mm screws	\$132.00/ea
JOR1072H	for 3.5mm screw	\$132.00/ea

BUY NOW



Jorvet 2.0mm Drill Bit Hard

JOR372BH	\$39.00/ea
----------	------------

BUY NOW



Jorvet Cortical Nut

BUY NOW

Occasionally tapped threads strip and a larger screw is inappropriate. Lag screws are particularly vulnerable, as only one cortex is available for tapping. A cortical nut manufactured from implant grade nylon can give the screw purchase to allow normal tightening. The thread form is designed to grip the screw to minimize backing out. Sterile.

JOR375A	2.7mm	\$15.00/ea
JOR375B	3.5mm	\$19.50/ea
JOR375C	4.5mm	\$21.00/ea



Pin Removal Forceps

Pin removal is made easy with this forceps. Also useful for bending, holding, and cutting small pins and wires. Parallel action pliers may be used in tandem with bone plate bender for contouring smaller plates.

JOR442	Stainless Steel, w/Wire Cutter	\$252.00/ea
--------	--------------------------------	-------------

BUY NOW



Jorvet Enclosed Bone Pin Cutter

Completely covers a bone pin up to 4mm (5/32"). Addresses the problems created by open end standard pin cutters. The enclosed shearing action of the pin cutter:

- Eliminates the potentially dangerous flying pin end.
- Removes sharp point that can irritate soft tissue or cut the patient or people coming into contact.
- Eliminates the slightly deformed pin end that could jam the KE clamps.

JOR220P	up to 4mm (5/32")	\$224.00/ea
---------	-------------------	-------------

BUY NOW



Pincutter with Breakdown Handle

Large pin cutter similar to JOR220 only handles detach to fit into smaller autoclaves. From 490mm (19 3/8") to 260mm (10 3/8"). Gold colored handles with tungsten carbide inserts.

JOR2200	\$340.00/ea
---------	-------------



BUY NOW

We do not stock all Orthopedic Products. Note that Jorvet/Jorgensen brand Products have a \$10 Dropship fee, as well as extra overnight fees.

13822 WEST BOULTON BLVD. METAWA, IL 60045

WWW.SHOPMEDVET.COM

Phone 800-544-7521

24/7

Fax 800-204-2177



Cortical Self Tapping Screws & Compression Plates

Cortical Self-Tapping Screw 2.7mm

Jorvet BUY NOW

JOR419AS	6mm L	\$9.00/ea	JOR419IS	22mm L	\$12.00/ea
JOR419BS	8mm L	\$9.00/ea	JOR419JS	24mm L	\$12.00/ea
JOR419CS	10mm L	\$10.50/ea	JOR419KS	26mm L	\$12.00/ea
JOR419DS	12mm L	\$10.50/ea	JOR419LS	28mm L	\$12.00/ea
JOR419ES	14mm L	\$10.50/ea	JOR419MS	30mm L	\$12.00/ea
JOR419FS	16mm L	\$10.50/ea	JOR419NS	32mm L	\$12.00/ea
JOR419GS	18mm L	\$10.50/ea	JOR419OS	34mm L	\$12.00/ea
JOR419HS	20mm L	\$10.50/ea	JOR419PS	36mm L	\$13.50/ea
JOR419HS	20mm L	\$15.00/ea	JOR419RS	40mm L	\$13.50/ea

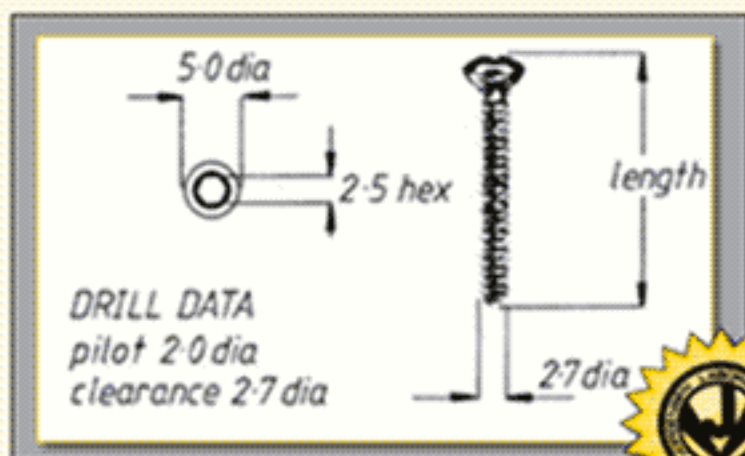

Cortical Self-Tapping Screw 4.5mm

JOR426AS	14mm L	\$14.40/ea
JOR426DS	26mm L	\$15.00/ea
JOR426ES	30mm L	\$15.00/ea
JOR426FS	28mm L	\$15.00/ea

BUY NOW



Jorvet Compression Plates 2.0mm

2mm Compression Plate. Use with 2mm cortical screws if compression is required.

BUY NOW

JOR417A	4 holes, 22mm	\$57.00/ea
JOR417B	5 holes, 27mm	\$57.00/ea
JOR417C	6 holes, 32mm	\$58.00/ea
JOR417D	7 holes, 37mm	\$66.00/ea
JOR417E	8 holes, 42mm	\$66.00/ea

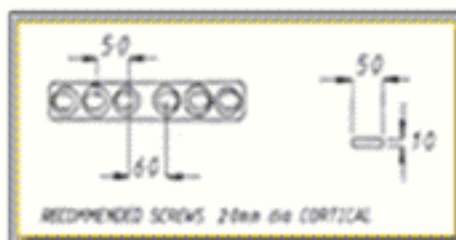

Disposable Plastic Cannulae

BUY NOW

Holes in cannulae allow suture attachment.

JOR40PC	10/pk	\$64.00
---------	-------	---------

Jorvet

Cortical Self-Tapping Screw 3.5mm

Jorvet BUY NOW

JOR421AS	10mm L	\$10.50/ea	JOR421IS	3.5mm x 26mm	\$18.80/ea
JOR421BS	12mm L	\$10.50/ea	JOR421JS	3.5mm x 28mm	\$10.50/ea
JOR421CS	14mm L	\$10.50/ea	JOR421KS	3.5mm x 30mm	\$10.50/ea
JOR421DS	3.5mm x 16mm	\$10.50/ea	JOR421LS	3.5mm x 32mm	\$12.00/ea
JOR421ES	3.5mm x 18mm	\$10.50/ea	JOR421MS	3.5mm x 34mm	\$11.25/ea
JOR421FS	3.5mm x 20mm	\$10.50/ea	JOR421NS	3.5mm x 36mm	\$18.00/ea
JOR421GS	3.5mm x 22mm	\$13.50/ea	JOR421OS	3.5mm x 40mm	\$15.00/ea
JOR421HS	3.5mm x 24mm	\$14.10/ea	JOR421TS	3.5mm x 38mm	\$11.25/ea

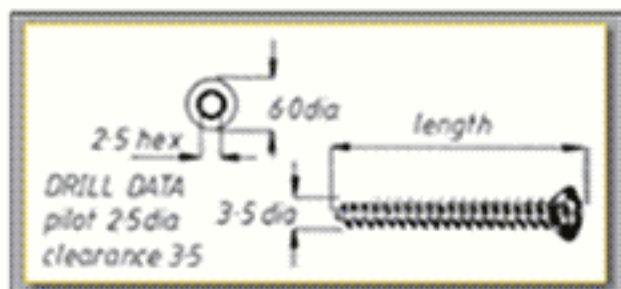

Pearson Raised Thread Pins

Smooth-shank pins have poor resistance to pull out. Negative-thread pins are weak. Positive or raised thread pins offer strength and good pull-out resistance. The Pearson pin addresses three major problems associated with the use of threaded pins:

1. Threads are proud of the shank, eliminating the point of weakness found at the thread-shank interface of negative-thread pins.
2. Existing self-tapping pins impact bone debris at the bone pin interface, causing necrosis and microfractures. The Pearson pin has a unique flute form that collects bone debris as it is formed, minimizing damage to the bonepin interface.
3. Trocar tipped pins cause thermal necrosis if inserted without pre-drilling. Pre-drilling takes time and causes soft tissue damage. The Pearson pin incorporates a unique drill point designed for minimal "skate" on the bone surface. The pin pre-drills its own pilot hole. The Pearson pin is available in 1/8", 5/32", and 1/4" shanks, with either end-thread or mid-thread.

BUY NOW

JOR371HP	End-Thread Pin, 5/32" shank, 6"L	\$31.00/ea
JOR371BP	Mid-Thread Pin, 1/8" shank, 5"L	\$39.00/ea

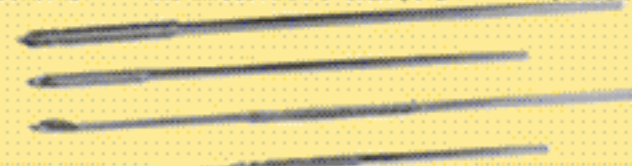

We do not stock all Orthopedic Products. Note that Jorvet/Jorgensen brand Products have a \$10 Dropship fee, as well as extra overnight fees.

13822 WEST BOULTON BLVD. METAWA, IL 60045

WWW.SHOPMEDVET.COM

Phone 800-544-7521

24/7

Fax 800-204-2177



Jorvet Bone Drill Bit



BUY NOW

For pre-drilling positive profile pins. Pre-drill with a bit slightly smaller than the pin shank.

JOR372J	1.9mm for 2.0mm (5/64") Positive KE X-small pins	\$27.00/ea
JOR372K	2.3mm for 2.4mm (3/32") Positive KE small pins	\$26.00/ea
JOR372L	3.0mm for 3.2mm (1/8") Positive KE medium pins	\$27.00/ea
JOR372N	3.8mm for 4.0mm (5/32") Positive KE large pins	\$32.00/ea

Jorvet Anti-Skid Drill Bits

BUY NOW

These drill bits have a sharp needle point tip that penetrates the bone for easier drilling. It helps avoid skipping over the bone especially if drilling at an angle other than 90°. Made from hard 420 stainless steel.

JOR372FX	Bit: 9/64", 3.5mm., Length 13cmv	\$40.00/ea
JOR372AX	Bit: 1/16", 1.5mm., Length 6cmv	\$45.00/ea
JOR372BX	Bit: 5/64", 2.0mm., Length 10cmv	\$41.50/ea
JOR372CX	Bit: 3/32", 2.5mm., Length 11.5cmv	\$41.50/ea
JOR372DX	Bit: 7/64", 2.7mm., Length 13cm.v	\$40.00/ea
JOR372EX	Bit: 1/8", 3.2mm., Length 13cmv	\$40.00/ea
JOR372GX	Bit: 5/32", 4.5mm., Length 13cmv	\$40.00/ea

For pre-drilling positive profile pins. Pre-drill with a bit slightly smaller than the pin shank.

JOR372CZ	<ul style="list-style-type: none"> • 2.5mm drill bit. • Standard razor tip • Gold titanium nitride coating finish • Will out-last and out-perform any standard drill bit 	\$39.50/ea
----------	--	------------

BUY NOW



Orthopedic Drill Case w/9 Drill Bits

Drill Case with 9 different standard drill bits (JOR372A-I).

JOR372XC	\$330.00/ea
----------	-------------

Stainless Steel Orthopedic Drill Case

This folding box can hold 10 standard size drill bits. Autoclavable. Measures 5 1/2" x 4" x 3/4". Stainless steel. (Bits not included.)

JOR372X	\$199.00/ea
---------	-------------



Sherman Self-Tapping Plate System

JOR430	3.5mm and 2.7mm	\$1,700.00/ea
--------	-----------------	---------------

Includes:

(1)JOR372c Drill Bit. 3/32", 2.4mm	BUY NOW
(1)JOR372d Drill Bit. 7/64", 2.7mm	Jorvet
(1)JOR372f Drill Bit. 9/64", 3.5mm	
(1)JOR414 Small Drill Guide. 3.5mm i.d.	
(1)JOR414b Insert Sleeve 3.5/2.7mm	
(1)JOR401c Screwdriver only for 2.7mm Flat head	
(1)JOR401e Screwdriver only for 3.5mm Cruciate head	
(1)JOR853a Bone Plate Benders	
(1)JOR410 Depth Gauge	
(1)Self-Tapping Plating Case with 2.7/3.5mm screw rack	

Plates

(1)JOR408a	8 holes x 104mm
(1)JOR408b	9 holes x 117mm
(1)JOR408c	10 holes x 130mm
(1)JOR405c	2.7mm Round Hole Plate. 4 holes x 27mm
(1)JOR405e	2.7mm Round Hole Plate. 5 holes x 33mm
(1)J-405g	2.7mm Round Hole Plate. 6 holes x 39mm
(1)J-407d	3.5mm Round Hole Plate. 5 holes x 58mm
(1)JOR407f	3.5mm Round Hole Plate. 6 holes x 76mm
(1)JOR407g	3.5mm Round Hole Plate. 7 holes x 82mm

Screws

(1)JOR404a	2.7mm Self-Tapping Screw. 6/pkg. 10mm L
(1)JOR404b	2.7mm Self-Tapping Screw. 6/pkg. 13mm L
(1)JOR404c	2.7mm Self-Tapping Screw. 6/pkg. 16mm L
(1)JOR404d	2.7mm Self-Tapping Screw. 6/pkg. 19mm L
(1)JOR404e	2.7mm Self-Tapping Screw. 6/pkg. 22mm L
(1)JOR406c	3.5mm Self-Tapping Screw. 6/pkg. 16mm L
(1)JOR406d	3.5mm Self-Tapping Screw. 6/pkg. 19mm L
(1)JOR406e	3.5mm Self-Tapping Screw. 6/pkg. 22mm L
(1)JOR406f	3.5mm Self-Tapping Screw. 6/pkg. 25mm L
(1)JOR406g	3.5mm Self-Tapping Screw. 6/pkg. 28mm L
(1)JOR406h	3.5mm Self-Tapping Screw. 6/pkg. 31mm L
(1)JOR406i	3.5mm Self-Tapping Screw. 6/pkg. 34mm L
(1)JOR406j	3.5mm Self-Tapping Screw. 6/pkg. 38mm L
(1)JOR406k	3.5mm Self-Tapping Screw. 6/pkg. 41mm L
(1)JOR406l	3.5mm Self-Tapping Screw. 6/pkg. 44mm L

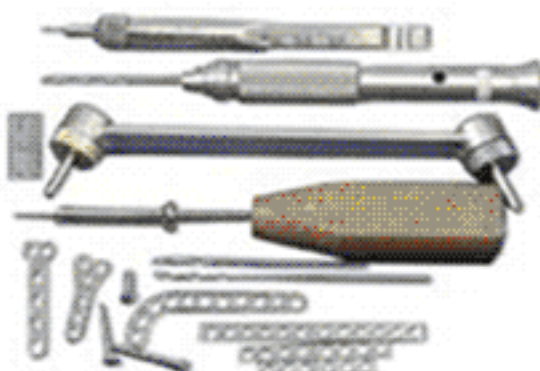

BUY NOW



We do not stock all Orthopedic Products. Note that Jorvet/Jorgensen brand Products have a \$10 Dropship fee, as well as extra overnight fees.

13822 WEST BOULTON BLVD. METAWA, IL 60045

WWW.SHOPMEDVET.COM

Phone 800-544-7521

243

Fax 800-204-2177



Jorvet Screwdriver with Sleeve

BUY NOW

JOR401E	For 3.5mm screw. Cruciate head	\$114.00/ea
JOR401A	Only for 2.0mm screw. Flat head	\$105.00/ea
JOR401C	Only for 2.7mm screw. Flat head	\$105.00/ea
JOR401B	Only for 2.0mm screw.	\$93.00/ea
JOR401D	For 2.7mm screw	\$87.00/ea



Jorvet 2mm Self-Tapping Screw

JOR402A	2mm x 6mm, 6pk	\$30.00/pk	JOR402E	2mm x 14mm, 6pk	\$31.50/pk
JOR402B	2mm x 8mm, 6pk	\$30.00/pk	JOR402F	2mm x 16mm, 6pk	\$31.50/pk
JOR402C	2mm x 10mm, 6pk	\$30.00/pk	JOR402G	2mm x 18mm, 6pk	\$33.00/pk
JOR402D	2mm x 12mm, 6pk	\$30.00/pk	JOR402H	2mm x 20mm, 6pk	\$33.00/pk

BUY NOW

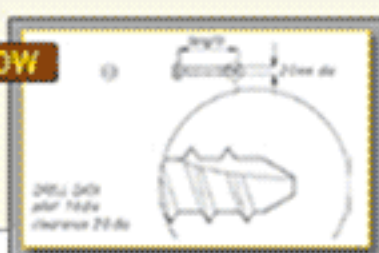

Jorvet 2.0mm Bone Plate (Round Holes)

JOR403A	2-hole 13mm	\$18.00/ea	JOR403F	6 holes, 30mm	\$37.00/ea
JOR403B	4-hole 20mm L	\$25.50/ea	JOR403G	6 holes, 33mm	\$37.00/ea
JOR403C	4 holes, 23mm	\$25.50/ea	JOR403H	7 holes, 35mm	\$41.00/ea
JOR403D	5 holes, 25mm	\$30.00/ea	JOR403I	7 holes, 38mm	\$42.00/ea
JOR403E	5 holes, 28mm	\$30.00/ea	JOR403J	8 holes, 40mm	\$44.00/ea
			JOR403K	8 holes, 43mm	\$47.00/ea

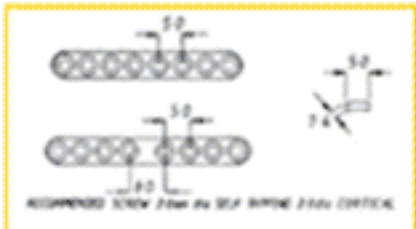

BUY NOW

2mm Sherman Self-Tapping Screw Kit

2mm Sherman Self-Tapping Screw Kit.

- (1) JOR401a Screwdriver for 2.0mm self-tapping screws.
- (1) JOR372a Pilot Drill Bit. 1.6mm.
- (1) JOR372b Drill Bit. 2.0mm.
- (1) JOR415a Sleeve for 2.0mm bit. For soft tissue protection.
- (1) JOR430cs Stainless Steel Case with screw rack.
- (1) JOR410a Depth Gauge Bone Screws: packages of 6 2.0mm Bone Plate. Round holes.
- (6) JOR402a 6mm
- (6) JOR402b 8mm
- (6) JOR402C 10mm
- (6) JOR403c Bone Plate. 4-hole 23mm L.
- (6) JOR402b 8mm
- (6) JOR403e Bone Plate. 5-hole 28mm L.
- (6) JOR403g Bone Plate. 6-hole 33mm L.



BUY NOW

Jorvet Self-Tapping Screw, 2.7mm (7/64")

For use with 2.7mm (7/64") round-hole plates in small- to medium-sized patients. 6/pk.

JOR404A	10mm L	\$31.50/pk	JOR404H	31mm L	\$31.50/pk
JOR404B	13mm L	\$31.50/pk	JOR404I	34mm L	\$31.50/pk
JOR404C	16mm L	\$31.50/pk	JOR404J	38mm L	\$31.50/pk
JOR404D	19mm L	\$31.50/pk	JOR404K	41mm L	\$33.00/pk
JOR404E	22mm L	\$31.50/pk	JOR404L	44mm L	\$33.00/pk
JOR404F	25mm L	\$31.50/pk	JOR404M	48mm L	\$33.00/pk
JOR404G	28mm L	\$31.50/pk	JOR404N	50mm L	\$37.00/pk
			JOR404O	57mm L	\$36.00/pk

BUY NOW

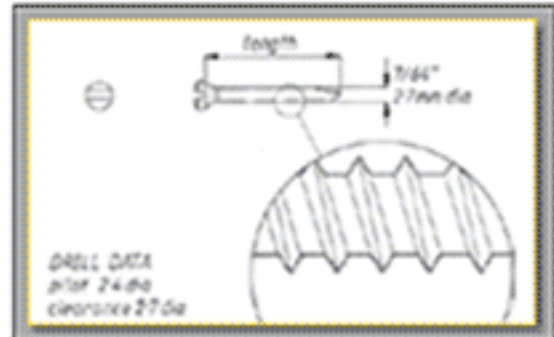

Jorvet Round Hole Plate 2.7mm

6mm W x 2mm thick bone plates for 2.7mm (7/64") screws. The 2.7mm round-hole plate has holes at 6mm intervals, and comes in a range of lengths.

JOR405A	2.7mm, 2 holes, 15mm	\$18.00/ea	JOR405G	2.7mm, 6 holes, 30mm	\$34.50/ea
JOR405B	2.7mm, 4 holes, 24mm	\$24.00/ea	JOR405H	2.7mm, 7 holes, 42mm	\$36.00/ea
JOR405C	2.7mm, 4 holes, 27mm	\$24.00/ea	JOR405I	2.7mm, 7 holes, 45mm	\$36.00/ea
JOR405D	2.7mm, 5 holes, 30mm	\$28.50/ea	JOR405J	2.7mm, 8 holes, 48mm	\$42.00/ea
JOR405E	2.7mm, 5 holes, 33mm	\$28.50/ea	JOR405K	2.7mm, 8 holes, 51mm	\$42.00/ea
JOR405F	2.7mm, 6 holes, 36mm	\$34.50/ea			

BUY NOW

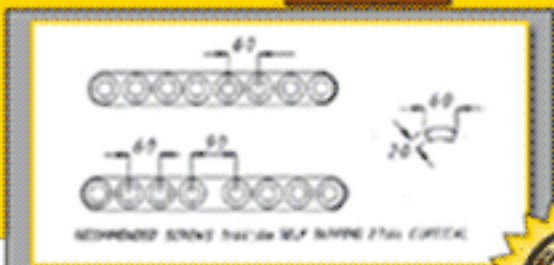

Reconstruction Bone Plate (cuttable and malleable)

JOR374A	24-hole. Uses 2.7mm screws. 150mm L.	\$152.00/ea
JOR374B	30-hole. Uses 2.0mm screws. 150mm L.	\$163.00/ea



BUY NOW

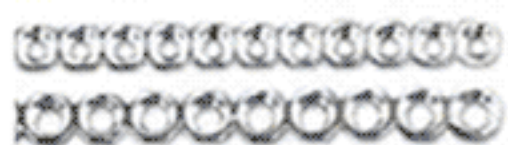

We do not stock all Orthopedic Products. Note that Jorvet/Jorgensen brand Products have a \$10 Dropship fee, as well as extra overnight fees.



Sherman Self Taping Screws & Basic Plating kit

Sherman Self Tap Screws, 3.5mm (9/64")

The 9/64" self-tapping screw has similar pull-out resistance to 3.5mm cortical screws. The main problem with this screw has been a lack of suitable bone plates. Our new range of 3.5mm round-hole plates considerably widens the scope of these self-tapping screws. Cruciate head. 6/pk.

BUY NOW

JOR406A	3.5mm x10mm, 6pk, cruciate	\$33.00/pk
JOR406B	3.5mm x 13mm, 6pk, cruciate	\$33.00/pk
JOR406C	3.5mm x 16mm, 6pk, cruciate	\$33.00/pk
JOR406D	3.5mm x19mm, 6pk, cruciate	\$33.00/pk
JOR406E	3.5mm x 22mm, 6pk, cruciate	\$33.00/pk
JOR406F	3.5mm x 25mm, 6pk, cruciate	\$33.00/pk
JOR406G	3.5mm x 28mm, 6pk, cruciate	\$33.00/pk
JOR406H	3.5mm x 31mm, 6pk, cruciate	\$33.00/pk
JOR406I	3.5mm x 34mm, 6pk, cruciate	\$42.00/pk
JOR406J	3.5mm x 38mm, 6pk, cruciate	\$42.00/pk
JOR406K	3.5mm x 41mm, 6pk, cruciate	\$43.50/pk
JOR406L	3.5mm x 44mm, 6pk, cruciate	\$42.00/pk
JOR406M	3.5mm x 48mm, 6pk, cruciate	\$42.00/pk
JOR406N	3.5mm x 50mm, 6pk, cruciate	\$42.00/pk
JOR406O	3.5mm x 57mm, 6pk, cruciate	\$42.00/pk

Round Hole Plate 3.5mm

A stronger and less expensive alternative to 3.5mm compression plates. Material is compatible with your choice of cortical or self-tapping screws.

BUY NOW



JOR407A	2 holes, 22mm	\$19.50/ea	JOR407I	8 holes, 94mm	\$47.00/ea
JOR407B	4 holes, 46mm	\$25.50/ea	JOR407J	8 holes, 100mm	\$47.00/ea
JOR407C	4 holes, 52mm	\$25.50/ea	JOR407K	9 holes, 106mm	\$49.00/ea
JOR407D	5 holes, 58mm	\$33.00/ea	JOR407L	9 holes, 118mm	\$49.00/ea
JOR407E	6 holes, 70mm	\$39.00/ea	JOR407M	10 holes, 118mm	\$54.00/ea
JOR407F	6 holes, 76mm	\$36.00/ea	JOR407N	10 holes, 130mm	\$55.00/ea
JOR407G	7 holes, 82mm	\$42.50/ea			
JOR407H	7 holes, 88mm	\$42.50/ea			

Compression Plating Case

BUY NOW

Stainless Steel Case. 2.7/3.5mm screw rack

JOR429D w 2.7/3.5mm Screw Rack \$340.00/ea



Bone Screw Rack

BUY NOW

JOR429D2M Rack for JOR429D \$130.00/ea

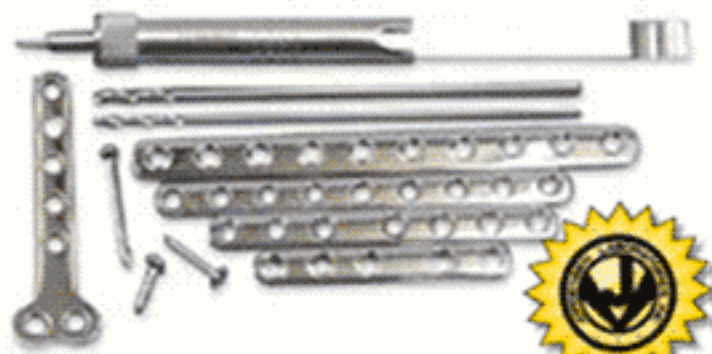

Round-Hole Plate 3.5mm Heavy-Duty

12mm W, 4mm thick heavy-duty plate is stronger than either the 3.5mm compression plate or our 3.5mm standard round-hole plate. Use of this plate makes 3.5mm cortical or 9/64" screws appropriate for the larger canine breeds.

JOR408A	8 holes 104mm	\$47.00/ea	JOR408E	12 holes 156mm	\$84.00/ea
JOR408B	10 holes 130mm	\$54.00/ea	JOR408F	13 holes 169mm	\$69.00/ea
JOR408C	10 holes 130mm	\$54.75/ea	JOR408G	14 holes 180mm	\$75.00/ea
JOR408D	11 holes 143mm	\$54.00/ea	JOR408H	15 holes 195mm	\$82.00/ea



BUY NOW



Compression Bone Plating Basic Kit

BUY NOW

The object of compression is to provide primary bone healing. A special guide is used to position the pilot drill hole. The corresponding tap then cuts the thread path. As the cortical screws are tightened through the unique plate holes, they are forced away from the side of the hole toward the fracture site. Compression of both fragments is then achieved. Set includes instrumentation and an assortment of implants for plating and lag screw procedures.

- (1)JOR372cz Drill Bit. 2.5mm
- (1)JOR372f Drill Bit. 3.5mm
- (1)JOR414 Drill Guide with point. 3.5mm i.d.
- (1)JOR414bb Insert Sleeve. 3.5mm o.d., 2.5mm i.d.
- (1)JOR409f Cortical Tap. 3.5mm
- (1)JOR409d Cancellous Tap. 4.0mm
- J-410 Depth Gauge (2.7-4.0mm)
- JOR411c Load/Neutral Drill Guide. 3.5mm plates
- Hex Head Screwdriver for 2.7/3.5/4.0 screw with sleeve
- Tap Handle
- Small Countersink with T-handle (2.7-4.0mm)
- Tap Sleeve
- Plate Benders
- 3.5mm Cortical Screws (6pk)
- (6)JOR421d 16mm
- (6)JOR421e 18mm
- (6)JOR421f 20mm
- (6)JOR421g 22mm
- (6)JOR421h 24mm
- (6)JOR421i 26mm
- (6)JOR421k 30mm
- 4.0 Cancellous Screws (6pk)
- (6)JOR424h 4mm 24mm L
- (6)JOR424j 4mm 28mm L
- (6)JOR424e 4mm 18mm L
- 3.5mm Compression Plates
- (1)JOR422d 5 holes x 62mm
- (1)JOR422e 6 holes x 74mm
- (1)JOR422f 7 holes x 86mm (1)JOR422g 8 holes x 98mm
- (1)JOR429d Stainless Steel Case. 2.7/3.5mm screw rack

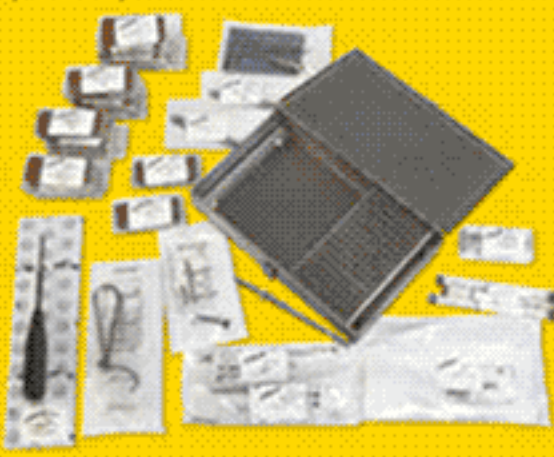

JOR429 \$2,150.00/ea

We do not stock all Orthopedic Products. Note that Jorvet/Jorgensen brand Products have a \$10 Dropship fee, as well as extra overnight fees.



Cortical/implant Kits, Screws & Plates

2mm Cortical Instrument/Implant Kit

2mm Cortical Instrument/Implant Kit

- JOR412a Screwdriver (2.0mm) with sleeve
- JOR409a Tap. 2.0mm
- JOR372ax Drill Bit. 1.5mm.
- JOR372b Drill Bit. 2.0mm.
- JOR214s Handle for 2.0mm tap.
- JOR411 Load Neutral Drill Guide
- JOR414sa Insert Sleeve. 2.0mm O.D./1.5mm I.D.
- JOR429cs Stainless Steel Case with screw rack.
- JOR410a Depth Gauge - mini
- Round holes.
- (6)JOR402a 6mm
- (6)JOR402b 8mm
- (6)JOR402c 10mm
- (6)JOR403c Bone Plate.
- 4-hole 23mm L.
- (6)JOR402b 8mm
- (6)JOR403a Bone Plate. 5-hole 28mm L.
- (6)JOR403g Bone Plate. 6-hole 33mm L.



BUY NOW

JOR429S \$1,775.00/ea

Jorvet Cortical Screws 2.0mm

Available in 6mm-24mm lengths, the spherical head of the screw produces compression when used in conjunction with 2mm compression plate.

JOR416D	12mm, 6pk	\$54.00/ea	JOR416B	8mm, 6pk	\$36.00/ea
JOR416E	14mm, 6pk	\$51.00/ea	JOR416CS	2.0mm x 10mm	\$12.00/ea
JOR416F	16mm, 6pk	\$42.00/ea	JOR416DS	2mm x 12mm	\$12.00/ea
JOR416C	10mm, 6pk	\$46.00/ea	JOR416H	20mm, 6pk	\$43.50/ea
JOR416G	18mm, 6pk	\$43.50/ea	JOR416I	22mm, 6pk	\$49.50/ea
JOR416A	6mm, 6pk	\$36.00/ea	JOR416J	24mm, 6pk	\$49.50/ea

BUY NOW

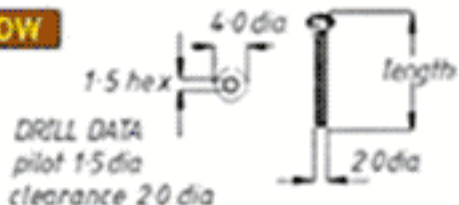

Jorvet

Jorvet Compression Plates 2.0mm

By carefully positioning cortical screws in the special holes in compression plates, compression can be exerted at the reduced fracture site as the screw is tightened. As the head of the screw strikes the edge of the plate's hole, the screw (and the associated bone) are forced away from the edge of the hole and toward the fracture site. The object of compression is to provide for primary bone union. A special guide must be used to position the screw hole accurately in the plate. Holes for cortical screws must be pre-tapped prior to screw placement.

BUY NOW

JOR417A	4 holes, 22mm	\$57.00/ea
JOR417B	5 holes, 27mm	\$57.00/ea
JOR417C	6 holes, 32mm	\$58.00/ea
JOR417D	7 holes, 37mm	\$66.00/ea
JOR417E	8 holes, 42mm	\$66.00/ea

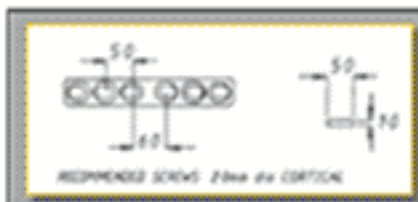

Compression Plate and Cortical Screw

By carefully positioning cortical screws in the special holes in compression plates, compression can be exerted at the reduced fracture site as the screw is tightened. As the head of the screw strikes the edge of the plate's hole, the screw (and the associated bone) are forced away from the edge of the hole and toward the fracture site. The object of compression is to provide for primary bone union. A special guide must be used to position the screw hole accurately in the plate. Holes for cortical screws must be pre-tapped prior to screw placement.

JOR409A	Cortical Tap. 2.0mm. Dental fit. (Use Tap handle)	\$92.00/ea
JOR409B	Cortical Tap. 2.7mm	\$70.00/ea
JOR409C	Cancellous Tap. 3.5mm. 1.75 pitch	\$57.00/ea
JOR409D	Cancellous Tap. 4.0mm. 1.75 pitch	\$61.00/ea
JOR409E	Cortical Tap. 4.5mm	\$69.50/ea
JOR409F	Cortical Tap. 3.5mm. 1.25 pitch	\$63.00/ea

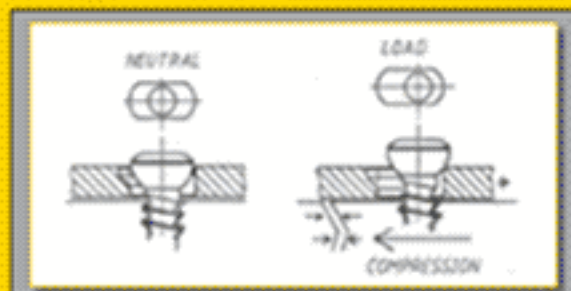

Jorvet

Mini Bone plate 2mm

BUY NOW

JOR418A	3 holes, 17mm	\$52.00/ea
JOR418B	4 holes, 23mm	\$48.00/ea
JOR418C	2.0mm, 5 holes, 29mm	\$51.00/ea
JOR418D	6 holes, 35mm	\$54.00/ea

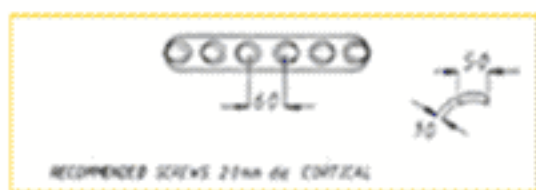

Jorvet Cancellous Screw 2.2mm

4mm Cancellous (Part Threaded) Lag Screw. For use as a lag screw without overdrilling of proximal fragment. 1/pkg.

Jorvet

JOR416BC	8mm L	\$9.00/ea	JOR416GC	168mm L	\$9.00/ea
JOR416CC	10mm L	\$9.00/ea	JOR416HC	20mm L	\$9.00/ea
JOR416DC	12mm L	\$9.00/ea	JOR416IC	22mm L	\$9.00/ea
JOR416EC	14mm L	\$9.00/ea	JOR416JC	24mm L	\$10.50/ea
JOR416FC	16mm L	\$9.00/ea			

BUY NOW

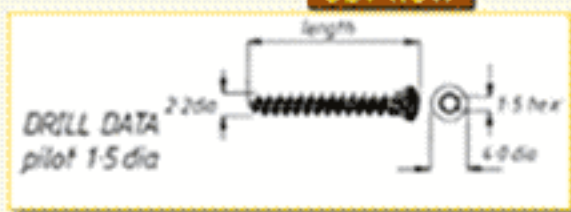

We do not stock all Orthopedic Products. Note that Jorvet/Jorgensen brand Products have a \$10 Dropship fee, as well as extra overnight fees.

13822 WEST BOULTON BLVD. METAWA, IL 60045

WWW.SHOPMEDVET.COM

Phone 800-544-7521

246

Fax 800-204-2177



Cortical Self Tapping Screws

2.7mm Cortical Screw and Equipment

JOR412b Hex Screwdriver for 2.7-4.0mm screws with sleeve.

JOR409b 2.7mm Tap.

JOR372b 2.0mm Pilot Drill Bit, Round shaft.

JOR372d 2.7mm Clearance Drill Bit, Round shaft.

JOR410 Depth Gauge, 2.7-4mm.

JOR413 Tap Handle for 2.7-4.5mm screws.

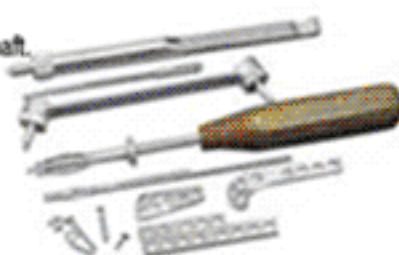

All 2.7 Cortical Screw Equipment Sold Individually Only

BUY NOW

2.4mm Cortical Self Tapping Screws

Titanium

JOR1072AT	6mm 2.0mm, Titanium	\$27.50/ea
JOR1072BT	Titanium, 8mm 2.0mm, Titanium	\$27.50/ea
JOR1072CT	10mm 2.0mm, Titanium	\$27.75/ea
JOR1072DT	12mm 2.0mm, Titanium	\$27.75/ea
JOR1072ET	14mm 2.0mm, Titanium	\$28.50/ea
JOR1072FT	16mm 2.0mm, Titanium	\$28.50/ea
JOR1072GT	18mm 2.0mm, Titanium	\$29.25/ea
JOR1072HT	20mm 2.0mm, Titanium	\$29.25/ea
JOR1072IT	22mm 2.0mm Titanium	\$30.00/ea
JOR1072JT	24mm 2.0mm, Titanium	\$30.00/ea
JOR1072KT	26mm 2.0mm, Titanium	\$30.75/ea
JOR1072LT	28mm 2.0mm, Titanium	\$33.00/ea
JOR1073LT	32mm x 2.4mm, Titanium	\$29.70/ea
JOR1073MT	34mm x 2.4mm, Titanium	\$30.00/ea
JOR1073NT	36mm x 2.4mm Titanium	\$30.60/ea
JOR1073N	36mm x 2.4mm Titanium	\$16.20/ea
JOR1073PT	38mm x 2.4mm, Titanium	\$30.60/ea
JOR1073P	38mm x 2.4mm	\$15.75/ea
JOR1073OT	40mm x 2.4mm, Titanium	\$30.90/ea

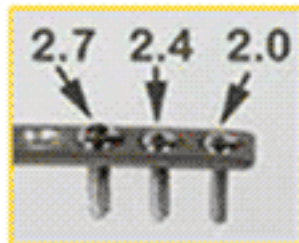

BUY NOW

Stainless Steel

JOR1073AA	16mm x 2.4mm	\$12.00/ea
JOR1073BB	8mm x 2.4mm	\$12.00/ea
JOR1073A	6mm x 2.4mm	\$12.00/ea
JOR1073B	12mm x 2.4mm	\$12.00/ea
JOR1073C	14mm x 2.4mm	\$13.50/ea
JOR1073D	16mm x 2.4mm	\$13.50/ea
JOR1073E	18mm x 2.4mm	\$14.25/ea
JOR1073F	20mm x 2.4mm	\$14.25/ea
JOR1073G	22mm x 2.4mm	\$14.25/ea
JOR1073H	24mm x 2.4mm	\$14.25/ea
JOR1073I	26mm x 2.4mm	\$15.00/ea
JOR1073J	28mm x 2.4mm	\$15.00/ea
JOR1073K	30mm x 2.4mm	\$15.00/ea
JOR1073L	32mm x 2.4mm	\$15.00/ea
JOR1073M	34mm x 2.4mm	\$15.00/ea
JOR1073Q	40mm x 2.4mm	\$15.75/ea

Titanium

JOR1073AT	6mm x 2.4mm	\$27.00/ea
JOR1073BT	12mm x 2.4mm	\$27.00/ea
JOR1073CT	14mm x 2.4mm	\$27.00/ea
JOR1073OT	16mm x 2.4mm	\$27.00/ea
JOR1073ET	18mm x 2.4mm	\$27.60/ea
JOR1073FT	20mm x 2.4mm	\$27.90/ea
JOR1073GT	22mm x 2.4mm	\$28.20/ea
JOR1073HT	24mm x 2.4mm	\$28.50/ea
JOR1073IT	26mm x 2.4mm	\$28.80/ea
JOR1073JT	28mm x 2.4mm	\$29.10/ea
JOR1073KT	30mm x 2.4mm	\$29.40/ea

BUY NOW

Jorvet 2.4mm Compression Plate

JOR1074A	4 hole 31mm	\$52.00/ea
JOR1074B	5 hole 38mm	\$56.00/ea
JOR1074C	6 hole 45mm	\$60.00/ea
JOR1074D	7 hole 52mm	\$64.00/ea
JOR1074E	8 hole 59mm	\$68.00/ea
JOR1074F	9 hole 66mm	\$80.00/ea
JOR1074G	10 hole 73mm	\$92.00/ea
JOR1074H	11 hole 80mm	\$101.00/ea
JOR1074I	12 hole 87mm	\$111.00/ea
JOR1074J	14 hole 104mm	\$123.00/ea
JOR1072A	1.8mm drill bit hard	\$33.00/ea
JOR1072CD	2.4 clear drill for 2.4 system	\$40.00/ea
JOR1073LNG	Load/Neutral Drill Guide for 2.4 system	\$252.00/ea
JOR412A	for 2.0mm screws, w/sleeve	\$112.00/ea
JOR1073SIP	1.5 hex screwdriver for 1.5, 2.0 & 2.4mm screws	\$312.00/ea



BUY NOW

2.4 PLATING KIT

- The 2.4 system is available as a boxed kit which
 - includes one of each plate, 5 of each screw up to
 - 30mm, drills, load/neutral guide and screwdriver.
- J-1073dcp 2.4 Plating Kit

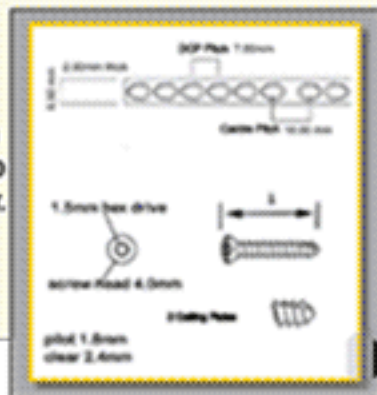

Jorvet Cortical Screws 2.7mm

2.7mm Cortical Screw. Use with 2.7mm compression and 2.7mm reconstruction plates to obtain compression at a fracture site.



BUY NOW

JOR419A	6mm Length, 6pk	\$49.50/jk	JOR419J	24mm Length, 6pk	\$48.00/jk
JOR419B	8mm Length, 6pk	\$49.50/jk	JOR419K	26mm Length, 6pk	\$50.00/jk
JOR419C	10mm Length, 6pk	\$49.50/jk	JOR419L	28mm Length, 6pk	\$54.00/jk
JOR419D	12mm Length, 6pk	\$49.50/jk	JOR419M	30mm Length, 6pk	\$57.00/jk
JOR419E	14mm Length, 6pk	\$48.00/jk	JOR419N	32mm Length, 6pk	\$58.50/jk
JOR419F	14mm Length, 6pk	\$43.50/ea	JOR419O	34mm Length, 6pk	\$63.00/jk
JOR419G	18mm Length, 6pk	\$48.00/jk	JOR419P	36mm Length, 6pk	\$66.00/jk
JOR419H	20mm Length, 6pk	\$48.00/jk	JOR419Q	38mm Length, 6pk	\$52.50/jk
JOR419I	22mm Length, 6pk	\$51.00/jk	JOR419R	40mm Length, 6pk	\$63.00/jk

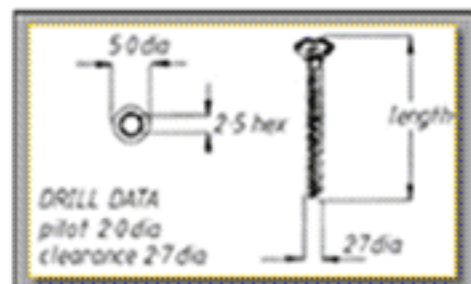

We do not stock all Orthopedic Products. Note that Jorvet/Jorgensen brand Products have a \$10 Dropship fee, as well as extra overnight fees.

13822 WEST BOULTON BLVD. METAWA, IL 60045

WWW.SHOPMEDVET.COM

Phone 800-544-7521

24/7

Fax 800-204-2177



Screws & Compression Plates

Jorvet Compression Plate 2.7mm

JOR420A	2 holes, 20mm L	\$39.00/ea	JOR420F	8 holes, 68mm L	\$63.00/ea
JOR420B	4 holes, 36mm	\$48.00/ea	JOR420G	9 holes, 76mm L	\$69.00/ea
JOR420C	5 holes, 44mm	\$49.50/ea	JOR420H	10 holes, 84mm L	\$78.00/ea
JOR420D	6 holes, 52mm	\$54.00/ea	JOR420I	12 holes, 100mm L	\$102.00/ea
JOR420E	7 holes, 60mm L	\$72.00/ea			

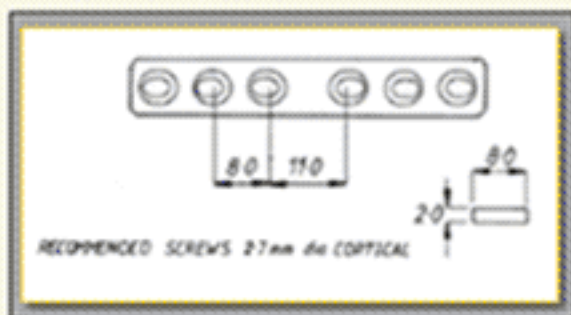

Jorvet

BUY NOW

Jorvet Cancellous 3mm Screw

2mm pilot. 2.5 hex head. Self-tapping. Single pack.

JOR419DC	12mm length	\$10.50/ea	JOR419JC	24mm length	\$10.50/ea
JOR419EC	14mm length	\$10.50/ea	JOR419KC	26mm length	\$10.50/ea
JOR419FC	16mm length	\$7.16/ea	JOR419LC	28mm length	\$10.50/ea
JOR419GC	18mm length, 6/pk	\$10.50/ea	JOR419MC	30mm length	\$10.50/ea
JOR419HC	20mm length	\$10.50/ea	JOR419NC	32mm length	\$10.50/ea
JOR419IC	22mm length	\$10.50/ea	JOR419OC	34mm length	\$10.50/ea
			JOR419PC	36mm length	\$12.00/ea

Cortical screws now available with self-tapping threads. Sold in single packs. (Add the letter "S" after each code.)

BUY NOW

Self-Tapping Screws. Self-Tapping screws save time and work extremely well in most circumstances especially in the proximal tibia for TPLO and TTO. Available in 2.0, 2.4, 2.7 and 3.5mm diameters.

3.5mm Compression Plate. Use with 3.5mm cortical or 3.5mm cancellous screws to produce fracture compression.

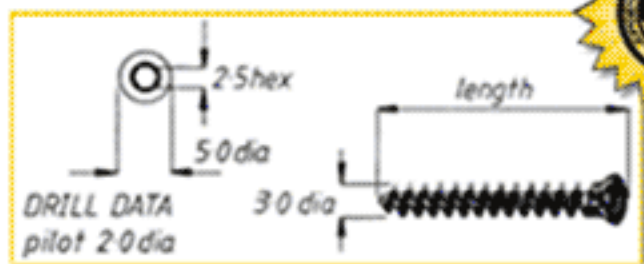

Jorvet Cortical Screws 3.5mm

This is the self-retaining blast trocar used in chronic bloats. Make a small 3/4" incision in hide. Screw the trocar into position. After insertion, the rumen should be pulled up close to the peritoneum by placing a few wraps of gauze between the trocar plate and hide.

JOR421A	10mm L	\$50.00/pk	JOR421J	28mm L	\$49.00/pk
JOR421B	12mm L	\$44.00/pk	JOR421K	30mm L	\$51.00/pk
JOR421C	14mm L	\$42.00/pk	JOR421L	32mm L	\$56.00/pk
JOR421D	16mm L	\$42.00/pk	JOR421M	34mm L	\$56.00/pk
JOR421E	18mm L	\$47.00/pk	JOR421N	36mm L	\$56.00/pk
JOR421F	20mm L	\$45.00/pk	JOR421O	40mm L	\$64.00/pk
JOR421G	22mm L	\$44.00/pk	JOR421P	45mm L	\$70.00/pk
JOR421H	24mm L	\$45.00/pk	JOR421Q	50mm L	\$74.50/pk
JOR421I	26mm L	\$42.00/pk	JOR421R	55mm L	\$88.00/pk
			JOR421S	60mm L	\$60.00/pk

Jorvet

BUY NOW

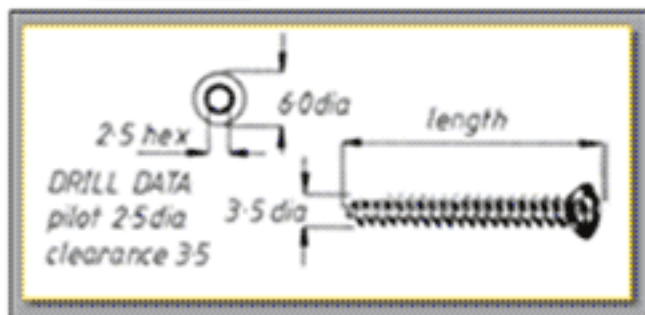

Jorvet Compression Plate 3.5mm

JOR422A	2 holes, 26mm L	\$48.00/ea	JOR422F	7 holes, 66mm L	\$60.00/ea
JOR422B	3 holes, 38mm L	\$49.50/ea	JOR422G	8 holes, 98mm L	\$57.00/ea
JOR422C	4 holes, 50mm L	\$48.00/ea	JOR422H	10 holes, 122mm L	\$78.00/ea
JOR422D	5 holes, 62mm L	\$57.00/ea	JOR422I	12 holes, 146mm L	\$80.00/ea
JOR422E	6 holes, 74mm L	\$57.00/ea			

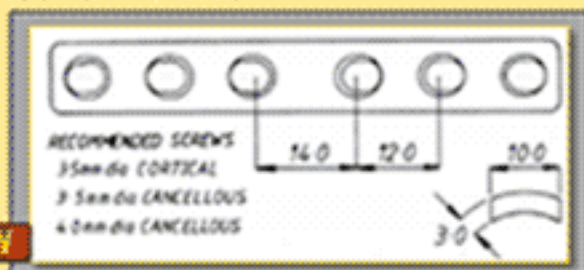

BUY NOW

Broad Compression Plate 3.5

3.5mm Broad Compression Plate. Uses the larger width 4.5mm compression plate with holes for 3.5mm cortical screws. A heavy-duty compression plate for bigger dogs.

JOR422BA	6 holes, 74mm L	\$54.00/ea	JOR422BE	10 holes, 122mm L	\$81.00/ea
JOR422BB	7 holes, 87mm L	\$60.00/ea	JOR422BF	11 holes, 134mm L	\$87.00/ea
JOR422BC	8 holes, 98mm L	\$69.00/ea	JOR422BG	12 holes, 146mm L	\$90.00/ea
JOR422BD	9 holes, 110mm L	\$75.00/ea	JOR422BH	13 holes, 158mm L	\$99.00/ea
			JOR422BI	14 holes, 170mm L	\$105.00/ea

We do not stock all Orthopedic Products. Note that Jorvet/Jorgensen brand Products have a \$10 Dropship fee, as well as extra overnight fees.

13822 WEST BOUTON BLVD. METAWA, IL 60045

Phone 800-544-7521

248

WWW.SHOPMEDVET.COM

Fax 800-204-2177



Screws & Compression Plates

Jorvet Cancellous Screws 3.5mm

3.5mm Cancellous Screw. 1.75 Pitch. The coarser thread has a much bigger "bite" into the bone. Use on metaphyseal or other cancellous bone. The screw needs its own tap. (JOR409c)

JOR423A	10mm L, 6pk	\$36.00/pk	JOR423J	28mm L, 6pk	\$45.00/pk
JOR423B	12mm L, 6pk	\$36.00/pk	JOR423K	30mm L, 6pk	\$51.00/pk
JOR423C	14mm L, 6pk	\$36.00/pk	JOR423L	32mm L, 6pk	\$51.00/pk
JOR423D	16mm L, 6pk	\$36.00/pk	JOR423M	34mm L, 6pk	\$51.00/pk
JOR423E	18mm L, 6pk	\$36.00/pk	JOR423N	36mm L, 6pk	\$51.00/pk
JOR423F	20mm L, 6pk	\$45.00/pk	JOR423O	40mm L, 6pk	\$75.00/pk
JOR423G	22mm L, 6pk	\$45.00/pk	JOR423P	45mm L, 6pk	\$54.00/pk
JOR423H	24mm L, 6pk	\$45.00/pk	JOR423Q	50mm L, 6pk	\$60.00/pk
JOR423I	26mm L, 6pk	\$45.00/pk	JOR423R	55mm L, 6pk	\$66.00/pk
			JOR423S	60mm L, 6pk	\$98.00/pk

Cancellous Screw, Fully Threaded, 4.0 mm

4mm Cancellous Screw, Full Thread. Use as cancellous screws where greater screw-bone interface is desirable. 6/pk.



JOR424A	10mm L	\$54.00/pk	JOR424H	24mm L	\$66.00/pk
JOR424B	12mm L	\$50.00/pk	JOR424I	26mm L	\$87.00/pk
JOR424C	14mm L	\$48.00/pk	JOR424J	28mm L	\$87.00/pk
JOR424D	16mm L	\$48.00/pk	JOR424K	30mm L	\$87.00/pk
JOR424E	18mm L	\$66.00/pk	JOR424L	35mm L	\$87.00/pk
JOR424F	20mm L	\$63.00/pk	JOR424M	40mm L	\$85.00/pk
JOR424G	22mm L	\$64.50/pk	JOR424N	45mm L	\$90.00/pk

Jorvet Cancellous Lag Screw 4.0mm

4mm Cancellous (Part Threaded) Lag Screw. For use as a lag screw without overdrilling of proximal fragment. 1/pkg.

BUY NOW

JOR425A	10mm L	\$7.50/ea	JOR425H	24mm L	\$9.00/ea
JOR425B	12mm L	\$9.00/ea	JOR425I	26mm L	\$9.00/ea
JOR425C	14mm L	\$7.50/ea	JOR425J	28mm L	\$10.50/ea
JOR425D	16mm L	\$7.50/ea	JOR425K	30mm L	\$15.00/ea
JOR425E	18mm L	\$9.00/ea	JOR425L	35mm L	\$11.40/ea
JOR425F	20mm L	\$12.00/ea	JOR425M	40mm L	\$11.40/ea
JOR425G	22mm L	\$9.30/ea	JOR425N	45mm L	\$15.00/ea

BUY NOW

JOR423A - JOR423S

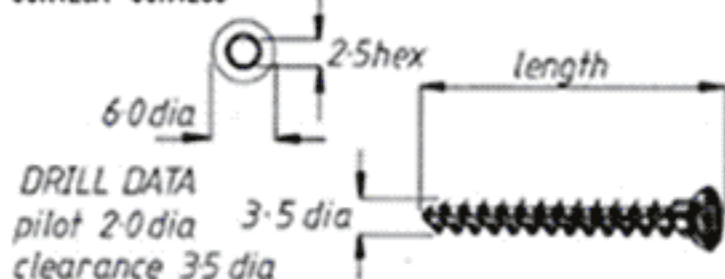

JOR424A - JOR424M

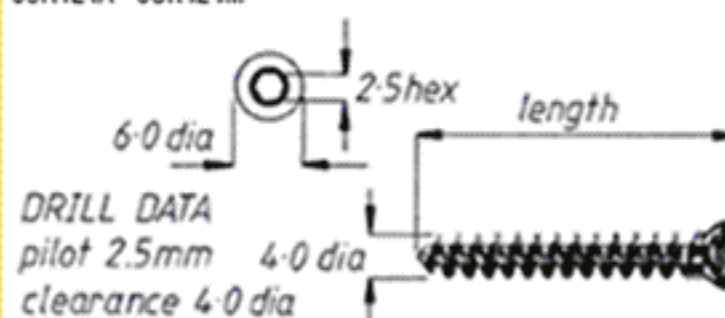

JOR425A - JOR425N

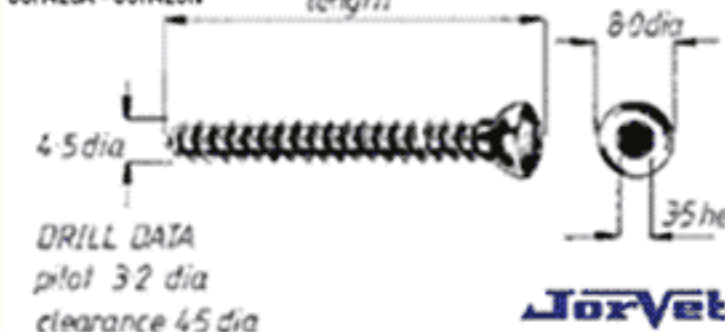

4.5mm Cortical Screw and Equipment

- JOR412c Hex Screwdriver for 4.5mm screws.
- JOR412cs Sleeve for above hex screwdriver.
- JOR409e 4.5mm Cortical Tap.
- JOR413 Tap Handle.
- JOR372e 3.2mm Pilot Hole Drill bit.
- JOR372h 4.5mm Clearance Drill Bit.
- JOR411d Load/Neutral Drill Guide.
- JOR414g Insert sleeve. 3.2-4.5mm

T-Bar tap 4.5mm Cortical

JOR409TB \$45.00/ea

BUY NOW

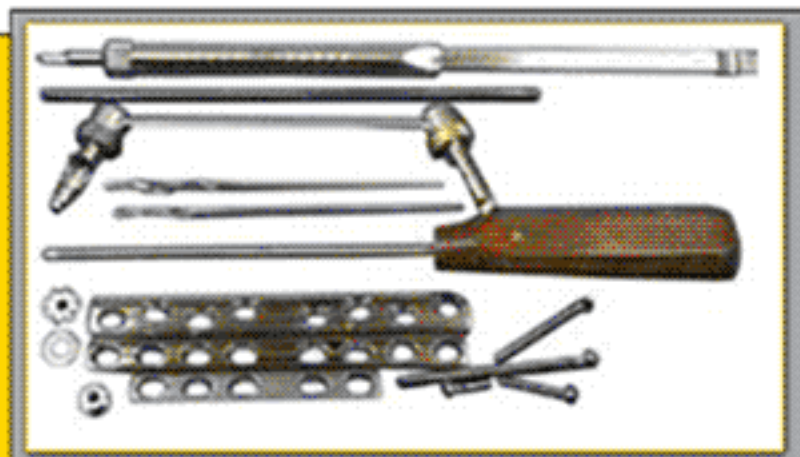

We do not stock all Orthopedic Products. Note that Jorvet/Jorgensen brand Products have a \$10 Dropship fee, as well as extra overnight fees.

13822 WEST BOULTON BLVD. METAWA, IL 60045

WWW.SHOPMEDVET.COM

Phone 800-544-7521

249

Fax 800-204-2177



Cortical Screws & Compression Plates

Jorvet Cortical Screws 4.5mm

4.5mm Cortical Screw. This cortical screw is suitable for very large dogs and equine patients.

BUY NOW

JOR426A	14mm L, 6/pk	\$57.00/pk	JOR426H	42mm L, 6/pk	\$63.00/pk
JOR426B	18mm L, 6/pk	\$52.50/pk	JOR426I	46mm L, 6/pk	\$66.00/pk
JOR426C	22mm L, 6/pk	\$50.00/pk	JOR426J	50mm L, 6/pk	\$66.00/pk
JOR426D	26mm L, 6/pk	\$63.00/pk	JOR426K	54mm L, 6/pk	\$66.00/pk
JOR426E	30mm L, 6/pk	\$60.00/pk	JOR426L	58mm L, 6/pk	\$78.00/pk
JOR426F	34mm L, 6/pk	\$53.00/pk	JOR416AS	2mm x 6mm	\$13.50/ea
JOR426G	38mm L, 6/pk	\$57.00/pk	JOR416ES	2mm x 14mm	\$12.00/ea
			JOR416FS	2mm x 16mm	\$12.00/ea

Jorvet

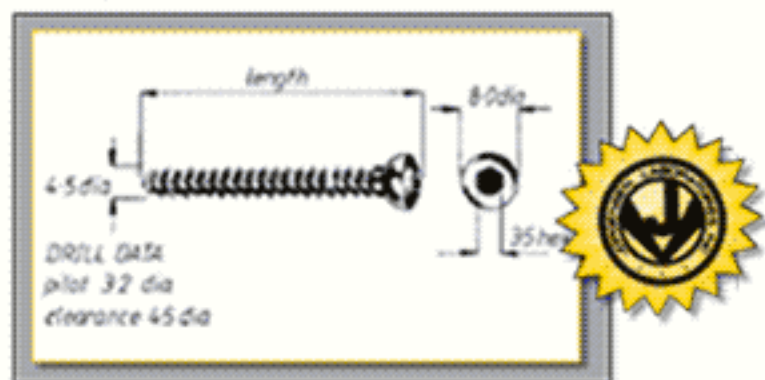

Jorvet Broad Plates 4.5mm

4.5mm Broad Plates. This is the strongest plate available for small animal orthopedics.

BUY NOW

Jorvet

JOR427DB	5 hole, 87mm L	\$60.00/ea	JOR427KB	13 hole, 215 mm L	\$98.00/ea
JOR427EB	6 hole, 103mm L	\$63.00/ea	JOR427LB	14 hole, 231mm L	\$105.00/ea
JOR427FB	7 hole, 119mm L	\$69.00/ea	JOR427MB	15 hole, 247mm L	\$112.00/ea
JOR427GB	8 hole, 135mm L	\$75.00/ea	JOR427NB	16 hole, 263mm L	\$116.00/ea
JOR427HB	9 hole, 151mm L	\$81.00/ea	JOR427OB	17 hole, 279mm L	\$119.00/ea
JOR427JB	10 hole, 167mm L	\$88.00/ea	JOR427PB	18 hole, 295mm L	\$130.00/ea
JOR427JB	12 hole, 199mm L	\$96.00/ea			

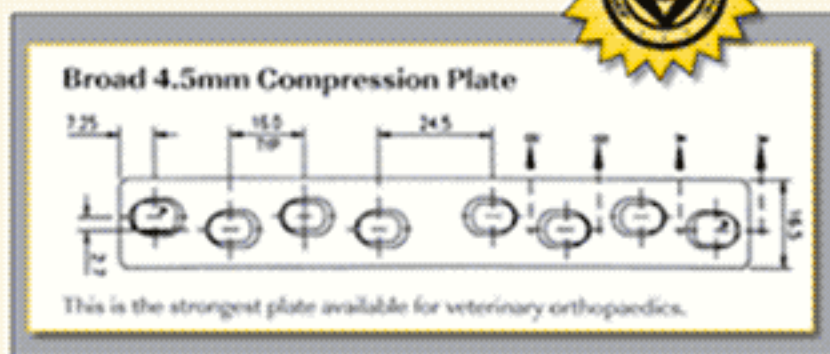

Jorvet Compression Plate 4.5mm

BUY NOW

Use with 4.5mm cortical screws to produce fracture-site compression.

Jorvet

JOR427C	4-hole, 71mm L	\$45.00/ea	JOR427G	9 holes, 151mm L	\$75.00/ea
JOR427A	2 holes, 39mm L	\$30.00/ea	JOR427H	10 holes, 167mm L	\$81.00/ea
JOR427B	3 holes, 55mm L	\$36.00/ea	JOR427I	11 holes, 183mm L	\$86.00/ea
JOR427D	5 holes, 87mm L	\$51.00/ea	JOR427J	12 holes, 199mm L	\$90.00/ea
JOR427F	8 holes, 135mm L	\$69.00/ea	JOR427E	6-hole, 103mm L	\$59.00/ea

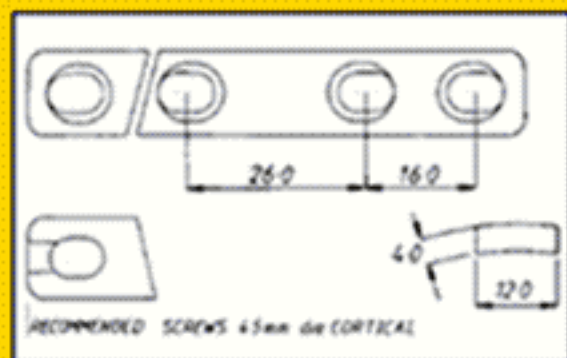

BUY NOW

Acetabular Bone Plates

BUY NOW

JOR373A	Very Small Plate, Uses 2.0mm screws, 4 hole	\$72.00/ea
JOR373B	Small plate, Uses 2.0mm screws, 4 hole	\$72.00/ea
JOR373C	Medium plate, Uses 2.7mm screws, 6 hole	\$87.00/ea
JOR373D	Large plate, Uses 2.7mm screws, 6 hole	\$87.00/ea
JOR373E	X-Large plate, Uses 3.5mm screws, 6 hole	\$101.00/ea
JOR373F	XX-Large plate, Uses 3.5mm screws, 6 hole	\$101.00/ea



Jorvet Carpal Arthrodesis Plates

JOR428H	Round Hole 2.7mm/3.5mm, 112mm	\$86.00/ea
JOR428J	Compression, 2.7mm/3.5mm, 112mm	\$117.00/ea
JOR428JL	Extended length to increase over metacarpals, 2.7mm/3.5mm, 118mm	\$114.00/ea
JOR428K	Compression, 2.0mm/2.7mm, 75mm	\$114.00/ea
JOR428L	Round-Hole, 2.0mm/2.7mm, 75mm	\$86.00/ea
JOR428M	Broad Compression, 3.5mm/3.5mm, 140mm	\$114.00/ea
JOR428N	Broad Round-Hole, 3.5mm/3.5mm, 140mm	\$110.00/ea
JOR428W	Carpal Arthrodesis, 1.5/2.0mm DCP, 54mm	\$110.00/ea
JOR428Y	Carpal Arthrodesis 2.2mm DCP	\$109.00/ea
JOR428Z	Intertarsal Arthrodesis PL, 2/2.7mm	\$117.00/ea

We do not stock all Orthopedic Products. Note that Jorvet/Jorgensen brand Products have a \$10 Dropship fee, as well as extra overnight fees.

13822 WEST BOULTON BLVD. METAWA, IL 60045

Phone 800-544-7521

250

WWW.SHOPMEDVET.COM

Fax 800-204-2177



Bone Plates

Jorvet "T"-Plate

Available for 3.5, 2.7, and 2.0mm screws, either cortical or self-tapping. "T" plates are used almost exclusively for the repair of fractures of the distal radius. In addition, they also may be used in a partial carpal arthrodesis.



BUY NOW

JOR428A	2mm, 4 hole, 18mm L	\$34.50/ea
JOR428B	2.0mm, 4-hole. Left angle, 18mm	\$34.50/ea
JOR428C	2.0mm, 4-hole. Right Angle, 18mm	\$36.00/ea
JOR428D	2.7mm, 5-hole, 32mm	\$28.50/ea
JOR428E	2.7mm, 5 hole Left Angled, 32mm	\$36.00/ea
JOR428F	5 Hole Right Angle, 32mm	\$45.90/ea
JOR428G	3.5mm, 6 hole, 55mm	\$49.00/ea

Hybrid "T" Plates

The problem with many distal radius fractures is the distal segment is so small that it is difficult to place sufficient screws. A "T" plate can help but often the head of the plate is too wide. Hybrid "T" plates can provide a solution.

- Screw holes in the head are smaller and closer together than those in the shaft
- Plate will accept same size screw in the head as in the shaft, but with reduced screw angulations

BUY NOW

JOR829A	1.5 or 2mm head 2mm shaft 32mm length of shaft	\$86.00/ea
JOR829	2.7 or 3.5mm head 3.5mm shaft 62mm length of shaft	\$92.00/ea

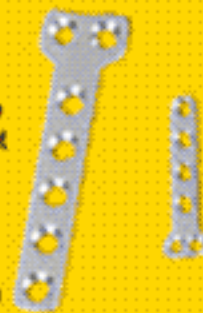

Pantarsal Arthrodesis Plate.

The surgical immobilization of the hock joint can be difficult. A medially applied plate appears to best neutralize the effect of the long lever arm created by arthrodesis. Data from the manufacture of 50 custom plates has enabled Jorvet to create a pantarsal plate which fits most medium and large dogs. The proximal portion is standard 3.5mm DCP, broadening over the vulnerable calcaneocubital region, and finally tapering out over the metatarsals as a 2.7mm DCP.

BUY NOW

JOR433A	left, 2.7 / 3.5mm	\$165.00/ea
---------	-------------------	-------------



Pantarsal Arthrodesis Plate

For small dogs. Overall length 100mm. 2.7mm/2.0mm screws.

BUY NOW

JOR433BL	Left	\$150.00/ea
JOR433BR	Right	\$150.00/ea

Our pantarsal plate is 135° with the middle screw placed in the center of the talus or the center of motion of the joint. This is not a one size fits all, but the only alternative is a custom plate. For cats. Overall length 78mm. 120° angle, better to match feline anatomy especially useful for severe shearing injuries. 2.7mm/2.0mm screw

BUY NOW

JOR433CL	Left, 2.0mm, 2.7mm	\$150.00/ea
JOR433CR	Right, Left, 2.0mm, 2.7mm	\$150.00/ea
JOR433	Right, 2.7 / 3.5mm	\$158.00/ea



Intertarsal Arthrodesis Compression Plate

is slightly wider and the holes are positioned to cover the metatarsal more completely. Middle hole picks up the central tarsal bone and T4. 2.0mm/2.7mm (shellie size). (not pictured) 55mm.

BUY NOW

JOR428Z	Intertarsal Arthrodesis PL, 2/2.7mm	\$117.00/ea
---------	-------------------------------------	-------------



Jorvet Distal Femur Plate

Fracture repair in the supracondylar femur region can be challenging, particularly in medium to large dogs. Forces acting on this region are complex and must be neutralized. In addition, the bone shape makes the use of standard plates virtually impossible. Jorvet supracondylar plates are designed to fit the distal femur with a minimum of further contouring. These plates are curved on the distal end to follow the natural bone curvature. The plate thickness tapers distally from 1.5mm to 1mm on 2mm plates. In cats and small dogs supracondylar fractures are usually simple and transverse, hence the 2mm plates are relatively lightweight. Medium and larger dogs typically have more complex fractures at this site with multiple fragments, requiring much more plate support. Our 2.7 and 3.5 plate's shape and strength reflect this. Apply the plate when possible to the lateral surface of the femur.

BUY NOW

JOR426P	2.0mm Supracondylar Plate, Left, 50mm L	\$93.00/ea
JOR426O	2.0mm Supracondylar Plate, Right, 50mm L	\$93.00/ea
JOR426R	2.7mm Supracondylar Plate, Right, 70mm	\$139.00/ea
JOR426S	2.7mm Supracondylar Plate, Left, 70mm	\$139.00/ea
JOR426T	3.5mm Supracondylar Plate, Right, 170mm	\$232.00/ea
JOR426U	3.5mm Supracondylar Plate, Left, 170mm	\$232.00/ea



Supra Condylar Osteotomy Plates (SCOP)

Osteotomy of the distal femur is now a recognized technique for the management of patella luxation in medium and larger dogs with added femoral abnormality. The use of straight plates is difficult due to hole positioning and plate contouring. These supra condylar plates are computer designed to fit this area. Pre-contoured to minimize intra operative adjustments. For complex supra condylar fractures use our large supra condylar plates or distal femoral plates (see above).

JOR1076	2.7mm right	\$134.00/ea
JOR1076A	2.7mm left	\$135.00/ea
JOR1076B	3.5 mm right	\$168.00/ea
JOR1076C	3.5mm left	\$168.00/ea



BUY NOW

Jorvet

We do not stock all Orthopedic Products. Note that Jorvet/Jorgensen brand Products have a \$10 Dropship fee, as well as extra overnight fees.

13822 WEST BOULTON BLVD. METAWA, IL 60045

WWW.SHOPMEDVET.COM

Phone 800-544-7521

251

Fax 800-204-2177

Bone Plates & Gauzges



Tibial Wedge Osteotomy Plate

BUY NOW

These "T" plates are designed with 3 round holes in the top of the "T" and compression holes along the length of the shaft.

JOR822A	6-holes. 39mm L. Uses 2.7mm screws	\$75.00/ea
JOR822B	6-holes. 55mm L. Uses 3.5mm screws	\$103.00/ea
JOR822C	7-holes. 79mm L. Uses 3.5mm screws	\$103.00/ea
JOR822D	6-holes. 26mm L. Uses 2.0mm screws	\$35.00/ea

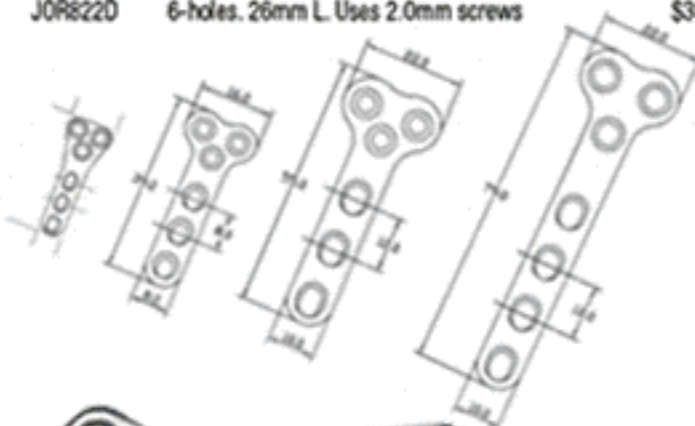

Standard TPLO Plate

BUY NOW

JorVet version of the original TPLO plates.

- Made of 316LVM implant grade stainless steel
- Milled, not cast The JorVet plate has been modified in the head region to make contouring easy while retaining the stiffness of 316LVM elsewhere for stability and rapid healing. The lower profile makes closure easier.

JOR438	3.5mm, Left	\$87.00/ea
JOR438A	3.5mm, Right	\$87.00/ea
JOR438B	2.7mm, Left	\$87.00/ea
JOR438C	2.7mm, Right	\$87.00/ea

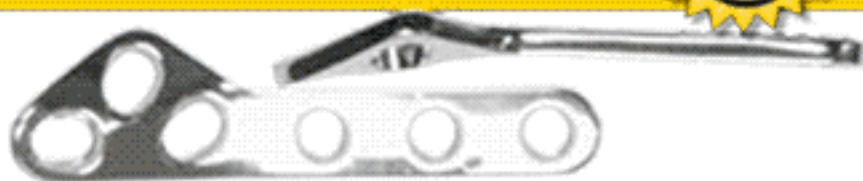

Standard TPLO Pre Contoured Plates

Standard TPLO pre contoured plates. Made of 316LVM milled material that is pre contoured for easy application.

JOR438AC	3.5mm Precontoured, Right	\$92.00/ea
JOR438BC	3.5mm precontoured left	\$92.00/ea

BUY NOW

Standard TPLO Pre Contoured Plates.

TPLO Guide Pin. End threaded negative pin. Drive directly into tibia for attachment of TPLO jig 3.2mm diameter with 25mm thread lengths.

JOR438GP	\$13.50/ea	BUY NOW
----------	------------	----------------

Self-Top Plating Case w 2.7/3.5mm Screw Rack

Stainless Steel Case. 2.7/3.5mm screw rack

JOR430D	\$342.00/ea	BUY NOW
---------	-------------	----------------

Biological Healing Plates

BUY NOW

These plates are designed to bridge a section of shattered long bone. It effectively acts as a buttress plate. No attempt is made to reconstruct. The fracture site is not disturbed to minimize de-vitalization and contamination. The plate maintains the length and permits weight bearing. Use of these plates avoids leaving empty screw holes over the fracture site. Empty holes significantly weaken the construct. Use when proximal and distal sections are intact and the body of the femur are un-reconstructable. All plates have round holes as there is no need for compression.

JOR433D	2.0mm 8 hole 65mm long - 6mm wide	\$51.00/ea
JOR433E	2.7mm 6 hole 68mm long - 7mm wide	\$57.50/ea
JOR433F	2.7mm 7 hole 67mm long - 7mm wide	\$57.50/ea
JOR433G	2.7mm 8 hole 75mm long - 7mm wide	\$52.00/ea
JOR433H	3.5mm 7 hole 120mm long - 10mm wide	\$57.50/ea
JOR433J	3.5mm 8 hole 130mm long - 10mm wide	\$57.50/ea
JOR433K	4.5mm 7 hole 138mm long - 10mm wide	\$63.75/ea
JOR433M	4.5mm 8 hole 150mm long - 10mm wide	\$63.75/ea
JOR433N	3.5mm 8 hole (Broad) 130mm long - 10mm wide	\$69.00/ea

Jorvet Bone Plate Clip

BUY NOW

The storage of plates in an orderly fashion is desirable. This inexpensive clip allows plate storage with quick access while making proper plate selection easier.

- Holds up to eight plates
- ID tag identifies each plate size

JOR430PC	3.5mm	\$19.80/ea
JOR430PCA	2.7mm	\$19.80/ea
JOR430PCB	2.0mm	\$19.80/ea



Jorvet TPLO Jig

JOR438J

JOR438J	\$320.00/ea	BUY NOW
---------	-------------	----------------



Jorvet Delta Style TPLO Plates (Precontoured)

These precontoured triangular TPLO plates keep additional bending to a minimum. Available in a wide range of sizes.

BUY NOW

JOR439	3.5mm standard left	\$94.00/ea
JOR439A	3.5mm standard right	\$94.00/ea
JOR439B	2.7mm left	\$93.00/ea
JOR439C	2.7mm right	\$93.00/ea
JOR439D	3.5mm broad left	\$105.00/ea
JOR439E	3.5mm broad right	\$105.00/ea
JOR439F	2.4mm left	\$93.00/ea
JOR439G	2.4mm right	\$93.00/ea



Long T Plate

BUY NOW

JOR439T	2.4mm 7 hole 52mm	\$84.00/ea
---------	-------------------	------------

JorVet

We do not stock all Orthopedic Products. Note that Jorvet/Jorgensen brand Products have a \$10 Dropship fee, as well as extra overnight fees.

13822 WEST BOULTON BLVD. METAWA, IL 60045

WWW.SHOPMEDVET.COM

Phone 800-544-7521

252

Fax 800-204-2177



TPLO Plates & Locking Screws

Suture Screw/Anchor

BUY NOW

Suture anchors have many uses, particularly reattachment of a ligament to bone. A screw is placed into bone and the head of the screw has an eyelet for suture placement. The screws are self-tapping after placement of a smaller pilot hole. A special driver is used to insert the screw. Suggested uses include:

- Coxo femoral luxations
- Shearing injuries
- Collateral ligament repairs
- Anchor for CCL lateral sutures

JOR836	Cortical Screw, 2.0mm, 10mm L, 1.0mm eyelet dia., 1.5mm pilot hole	\$30.50/ea
JOR836A	Cortical Screw, 14mm L, 1.5mm eyelet dia., 2.0mm pilot hole	\$30.50/ea
JOR836B	Cortical Screw, 20mm L, 2.0mm eyelet dia., 2.5mm pilot hole	\$30.50/ea
JOR836C	Cortical Screw, 24mm L, 2.0mm eyelet dia., 2.0mm pilot hole	\$30.50/ea
JOR836D	Cortical Screw, 6mm L, 1.0mm eyelet dia., 1.5mm pilot hole	\$30.50/ea
JOR836E	Cortical Screw, 8mm L, 1.5mm eyelet dia., 2.0mm pilot hole	\$30.50/ea
JOR836F	Cortical Screw, 12mm L, 2.0mm eyelet dia., 2.5mm pilot hole	\$30.50/ea

Also Required

JOR837	Screw Insertion Tool, 2mm	\$111.00/ea
JOR837A	Screw Insertion Tool, 2.7mm	\$98.00/ea



TPLO 3.5mm Locking Screw Pre Contoured Plate

BUY NOW

JorVet

The latest generation of TPLO plates involves the use of locking screws. The head of these special screws are threaded to coincide with threads on the inside of the plate hole. JorVet locking screws are made to international standards.

JOR438AL	Left, 5mm	\$114.00/ea
JOR438BL	Right, 3 3.5mm	\$114.00/ea

Locking Screws 3.5mm

(uses 2.7 mm pilot drill bit)

BUY NOW

JOR438LK	30mm	\$31.00/ea
JOR438LM	32mm	\$32.50/ea
JOR438LN	34mm	\$32.50/ea
JOR438LP	36mm	\$34.00/ea
JOR438LQ	38mm	\$35.50/ea
JOR438LD	18mm	\$29.00/ea
JOR438LE	20mm	\$29.00/ea
JOR438LF	22mm	\$29.00/ea
JOR438LG	24mm	\$31.00/ea
JOR438LH	26mm	\$31.00/ea
JOR438LJ	28mm will work on other brand of locking TPLO plates	\$31.00/ea



Bone Plate Press

BUY NOW

The JorVet Bone Plate Press is designed for animal plates and will fit in your autoclave. 2.7-4.5 narrow 12" long

JOR431LP	Large	\$337.00/ea
----------	-------	-------------

Jorvet Extra Large Bone Plate Press

Very large 16" (410mm) overall length. Suitable for 2.7- 4.5mm broad plates. Wide anvil.

BUY NOW

JOR431XL	Wide Anvil	\$340.00/ea
----------	------------	-------------

Jorvet Cortical Self-Tapping Screw

BUY NOW

JOR416AS	2mm x 6mm	\$13.50/ea
JOR416ES	2mm x 14mm	\$12.00/ea
JOR416FS	2mm x 16mm	\$12.00/ea

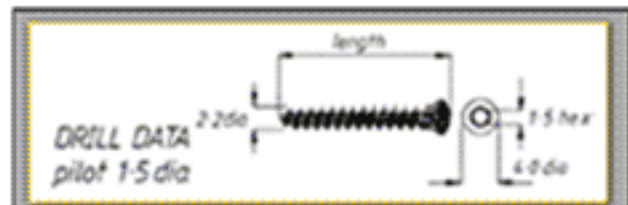

TPLO Plate

BUY NOW

"Y" style plate made by Aesculap. This plate has 3 compression screw holes. It works well when the proximal section will not fit a standard TPLO fit. Pre contoured.

JOR438S	Left Standard	\$119.00/ea
JOR438T	Right Standard	\$119.00/ea
JOR438Y	Plate Left Broad	\$144.00/ea
JOR438Z	Plate Right Broad	\$144.00/ea



Locking Screw Drill Guide

BUY NOW

The locking screw requires precise drilling to match threaded screw head to plate. It is essential to screw the guide into the plate prior to drilling the pilot hole.

JOR438DG	\$92.00/ea
----------	------------

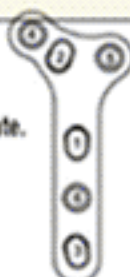

Locking Plug for TPLO Locking Screw

Used to protect locking holes while contouring plate

JOR438P	\$16.00/ea	BUY NOW
---------	------------	----------------

- Holes 4, 5, and 6 are for locking screws.
- Holes 1, 2 and 3 are for standard cortical screws.



We do not stock all Orthopedic Products. Note that Jorvet/Jorgensen brand Products have a \$10 Dropship fee, as well as extra overnight fees.

Orthopedic Products



Osteotomy Kit & Cruciate Staples

Triple Tibial Osteotomy Kit **BUY NOW**

- Kit Includes:
 (1)JOR436a Osteotometer
 (1)JOR436w Osteotomy Wedge
 (1)JOR436g Saw Guide
 (1)JOR436d DVD

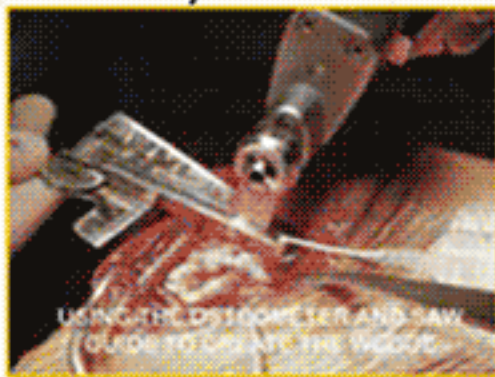

JOR436 \$380.00/ea

JorVet

Triple Osteotomy Plate **JorVet**

6-hole plate with 2 holes allowing compression designed specifically for triple osteotomy procedures. For use with 3.5mm x 4.0mm screws. Easily bend plate into desired angle.

JOR216	4.5cm L. Flat.	\$76.00/ea
JOR216A	TPO Large Plate, pre-bent, 30° - left side, length 48mm	\$85.00/ea
JOR216B	TPO Large Plate, pre-bent 30° - right side, 48mm	\$85.00/ea
JOR216C	TPO Small Plate, prebent 30° - left side, 35mm	\$85.00/ea
JOR216D	TPO small plate, prebent 30° - right side, 35mm	\$85.00/ea



Saw Guide for TTO **BUY NOW**

JOR436G \$135.00/ea

Osteotomy Wedge **BUY NOW**

JOR436W \$135.00/ea

Osteometer for TTO **BUY NOW**

JOR436A \$135.00/ea

Wedge Osteotomy Gauge Set **BUY NOW**

These 14 wedge gauges (8-22°) simplify marking and cutting of an appropriate wedge. Parallel marks on each gauge allow the surgeon to mark and cut a wedge having equal proximal and distal borders. Borders the same length result in a better closure both functionally and cosmetically.

JOR822S 14 Wedge Gauges (8-22°) \$120.00/ea

Wedge Angle Finder Overlay **BUY NOW**

A simple acetate overlay helps calculate the tibial plateau angle from which you can easily calculate the size of the wedge to remove. Included lines indicate the normal tibial plateau angle, and a 5° line, regarded as the most appropriate post-op angle. Also on the acetate are actual size outlines of range of TPO plates to help you select the most appropriate plate.

JOR822X Call For Pricing

Slocum/TPO Rotation Gauge **BUY NOW**

Eleven rotation gauges simplify the TPO rotation procedure. Correct millimeter measurement readings from the table assists selecting an appropriate gauge. Then mark the bone using the JOR822I scribe or an osteotome. No more need to work with cumbersome rulers. These 5-15mm gauges are on a handy -key ring.

JOR822F rotation gauge \$101.00/ea

Jorvet Cruciate Staples **BUY NOW**

Spikes under the head trap the autografts. Barbs on the legs prevent pull out. Cruciate staples provide very secure fixation of fascial autografts behind the femoral condyle. Any mallet can be used to drive the staple into the bone.

JOR83S	Staple Introducer. Jaws of staple introducer engage grooves in head of staple giving a very firm grip allowing accurate staple placement.	\$210.00/ea
JOR838K	Includes Introducer Plus 8 Staples	\$752.00/ea
JOR838M	Stainless Steel Case Only (for staple kit)	\$234.00/ea

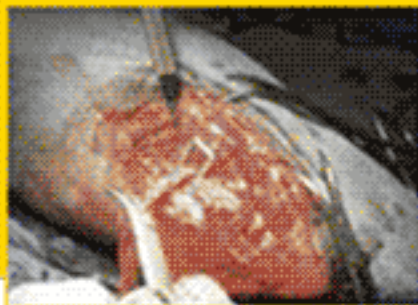

We do not stock all Orthopedic Products. Note that Jorvet/Jorgensen brand Products have a \$10 Dropship fee, as well as extra overnight fees.

13822 WEST BOULTON BLVD. METAWA, IL 60045

WWW.SHOPMEDVET.COM

Phone 800-544-7521

254

Fax 800-204-2177

Epoxy ESF Putty & Technovit



Epoxy ESF Putty **Jorvet**

This putty offers a quick and simple alternative to standard bar and clamp systems. The putty, once mixed, stiffens in five minutes and within one hour is fully cured. The putty comes in a round protective resealable 3/4" dia. tube. The amount required can be clipped off just like cookie dough. It has a pre-measured catalyst that is activated upon kneading or mixing.

Features:

- No liquid and powder mixing required
- No odor
- Immediately very moldable to shape
- Inexpensive compared to clamps/bars
- Applications:
- Different size pin placed at varying angles
- ESF in very small animals (i.e., guinea pig)
- Fractures of the mandible
- Protecting sharp ends of cut pins
- Joining non-standard pins and bars

BUY NOW



JOR751	55g Tube	\$7.50/ea
JOR751A	110g Tube	\$16.50/ea



Protection of Cut Ends of Pins



Stabilization of Opening Wedge Osteotomy



Stabilization of Bilateral Mandibular Fracture

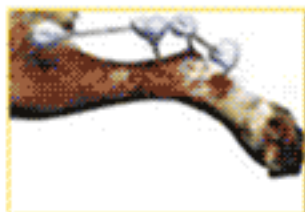

Stabilization of Medial Shearing Injury Rock



Fractured Tibia in a Cat



Tarsometatarsal Arthrodesis



Fractured Tibia in a Guinea Pig

Bone Cement Type 1: Medium Viscosity

Type 1: Medium Viscosity forms a digitally (finger) malleable putty.

Applications:

- Cement the acetabular component of a hip replacement
- Adjunct to acetabular fracture with pins and screws
- Spinal fractures
- Management of cervical wobblers by distraction fusion
- Filling dead space in equine tooth extractions
- Manufacturing of antibiotic impregnated beads (AIPMMA)
- Choose to add one's choice of suitable antibiotic or pre-added gentamycin, creating a slow release focal antibiotic. Especially useful in the management of refractory rabbit abscesses. Instructions included.



JOR912	40gm	\$114.00/ea
JOR912G	40gm with 1gm Gentamycin.	\$110.00/ea



Bone cement is a sterile form of Polymethyl Methacrylate (PMMA) originally formulated for use in hip replacement. It is available with or without antibiotics and a range of viscosities. In addition to hip replacement bone cement, veterinarians have found a wide range of other applications. There are two types that offer different viscosities for different applications. All consist of liquid/powder portions that are mixed together. Now includes sterile mixing bowls with spatula. This makes the process much easier with better odor control.

Bone Cement Type II: Low Viscosity

When mixed, is suitable for use through a syringe with a large catheter tip. Applications: Cementing the femoral prosthesis

BUY NOW



JOR913	40gm	\$108.00/ea
JOR913G	40gm with 1gm of Gentamycin	\$113.00/ea



Jorvet Technovit Dual Pouch

BUY NOW

Technovit (for external fixation use)

BUY NOW

Technovit: A powder and liquid that when mixed together form a hard acrylic. Methyl methacrylate compound is getting widespread use in veterinary medicine in a number of different applications. These forms require smaller, more specialized packaging than the standard hoof applications. Two relatively new uses include:

1. Acrylic in place of a connecting bar in the use of an external fixator. The acrylic can be shaped to follow body contours. An additional requirement is a tube-shaped container for holding the acrylic's shape while it cures.
2. A second use is in mixing an antibiotic powder together with the acrylic powder portion. Then the liquid portion is mixed in. The resulting mixture is shaped into very small beads that can be strung together like a string of pearls. The beads can be inserted into certain types of refractory wounds or abscesses. The bead acts as a time-release capsule for the antibiotic. The antibiotic leeches out directly into the infection site. The acrylic remains inert and is removed at a later date. The product is packaged in a heavy-duty 3ml sealed bag. The powder and liquid are separated by a plastic removable divider.



JOR860	30ml Liquid Pouch/50gm Powder	\$13.50/ea
JOR860A	60ml Liquid Pouch/100gm Powder	\$16.50/ea
JOR860B	120ml Liquid Pouch/200gm Powder	\$24.00/ea



JOR861 Single Tube Configuration Kit Includes:
60ml liquid pouch/100gm powder
8" section of plastic hollow tube, 22mm
2 plastic caps
Instructions for use \$18.00/ea

JOR861A Small Single Tube Configuration Kit Includes:
30ml liquid pouch/50gm powder • 6" section of plastic hollow tube, 15mm
2 plastic caps
Instructions for use \$18.00/ea

JOR862 Two-Tube Configuration Kit Includes:
120ml liquid pouch/200gm powder
18" section of plastic hollow tube, 22mm
4 plastic caps
Instructions for use \$30.00/ea

JOR862A Small Two-Tube Configuration Kit Includes:
60ml liquid pouch/100gm powder
18" section of plastic hollow tube, 15mm
4 plastic caps
Instructions for use \$24.00/ea

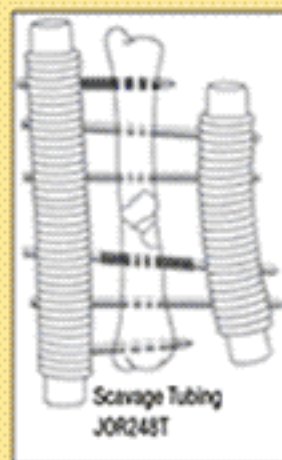

We do not stock all Orthopedic Products. Note that Jorvet/Jorgensen brand Products have a \$10 Dropship fee, as well as extra overnight fees.

13822 WEST BOUTON BLVD. METAWA, IL 60045

WWW.SHOPMEDVET.COM

Phone 800-544-7521

255

Fax 800-204-2177

Fixation Supplies

Jorvet Surgical Instrument Guards

JorVet instrument guards are designed to protect valuable instrument tips from damage during sterilization and handling. Sharp and pointed tips can break through sterilization pouches and injure the surgeon. 50/pkg.

- Non-sterile, but can be autoclaved or gas sterilized
- Medical-grade plastic (vented)
- Guards can also work as covers over exposed bone pins.

BUY NOW

JorVet

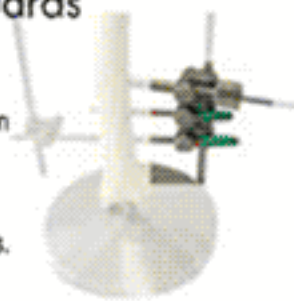

JOR926A	White, 1/16" x 3/4" (1.6mm x 19mm)	\$15.30/ea
JOR926B	Blue, 5/64" x 3/4" (2.0mm x 19mm)	\$15.30/ea
JOR926C	Green, 7/64" x 3/4" (2.8mm x 19mm)	\$15.30/ea
JOR926D	Red, 1/8" x 1" (3.2mm x 25mm)	\$15.30/ea



Drill Guide and Insert

BUY NOW

JOR414	Small. 3.5mm i.d. For 3.5mm drill bit.	\$124.00/ea
JOR414E	Large. 6.5mm i.d. For use with JOR414g insert sleeve and 4.5mm screw system.	\$175.00/ea

Jorvet Soft Tissue Protection Sleeve

Rotating pins, drills and taps will "pick up" soft tissue, skin, muscle, nerves and blood vessels, causing serious damage. Use of tissue protection sleeves minimizes such damage. The teeth at the top of the guide locate on the bone while the stainless steel tube provides a barrier between soft tissue and implant equipment.

BUY NOW

JOR415A	for drill/taps to 2.0mm	\$102.00/ea
JOR415B	for drill/taps to 2.7mm	\$98.00/ea
JOR415C	for drill/taps to 3.5mm	\$99.00/ea
JOR415D	for drill/taps to 4.5mm	\$100.00/ea



Countersinks

BUY NOW

This instrument contours the top of the screw hole to fit the screwhead. It is used for lag screw procedures and for the reattachment of small bone fragments.

JOR372W	Small Countersink, 2.7/3.5 and 4.0mm, Screw Heads with T-handle	\$82.00/ea
JOR372Y	Large countersink, 4.5 and higher screw, Quick Coupling End	\$101.00/ea
JOR409LH	Large countersink, T handle, 4.5-6.5mm	\$73.00/ea

Quick Release Tap Handle

Quick Release Tap Handle Synthes Fit. Fits all taps 2.7mm, 3.5mm, 4.0mm, and 4.5mm.

BUY NOW

JOR413	2.7mm - 4.5mm	\$238.00/ea
--------	---------------	-------------

Small Pin/Tap Chuck

JorVet

BUY NOW

JOR214S	for 2mm taps 4" length	\$111.00/ea
---------	------------------------	-------------



Jorvet KE Plus clamp

BUY NOW

Kirschner-Ehmer (KE) external fixation is a versatile system that has stood the test of time. Recent recommendations include the use of positive or raised profile pins. Traditional or standard KE clamps are difficult to use with positive profile pins. Also, standard KE clamps can only be used with one size pin. The new KE Plus Clamp can be used with positive profile and various sized pins.

JOR371A0	Small, Largest Thread/Shank 3.6mm (9/64") Smallest Thread/Shank 0.9mm (1/16")	\$30.00/ea
JOR371B0	Medium, Largest Thread/Shank 4.8mm (3/16") Smallest Thread/Shank 2.4mm (7/64")	\$33.00/ea
JOR371C0	Large, Largest Thread/Shank 6.5mm (1/4") Smallest Thread/Shank 3.0mm (1/8")	\$33.00/ea

Jorvet Split KE Clamp

JorVet

BUY NOW

The reduction and stabilization of complicated fractures is a time consuming procedure. If additional clamps and pins are found to be needed during surgery the whole frame must be disassembled. The split clamp allows the addition of clamps at any time during the surgery. A centrally placed washer increases holding power.

JOR371SCL	Large	\$60.00/ea
JOR371SCM	Medium	\$60.00/ea
JOR371SCS	Small	\$60.00/ea



Jorvet KE Tissue Protector

JorVet

Soft tissue protection is extremely important during the insertion of KE bone pins. Without soft tissue protection there is a tendency for soft tissue structures such as muscle, blood vessels, and nerves to be wrapped around the pin. This tendency is greatly increased with the use of raised threaded pins or drill bits. Other drill guides and tissue protectors will work when placing free standing pins. However, when placing pins in the middle of a KE frame, they can not be used.

JOR371TP	7"L	\$85.00/ea
----------	-----	------------



BUY NOW

Insert Sleeve (for Drill Guide)

BUY NOW

JOR414AA	2.0mm i.d. 1.5 for screw: 2.0mm Cortical JOR416 a-j. Fits inside JOR414a.	\$90.00/ea
JOR414A	3.5mm i.d. 2.0 for screw: 3.5mm Cancellous JOR423a-s*	\$90.00/ea
JOR4148B	3.5mm i.d. 2.5 for screw: 3.5mm Cortical JOR421 a-j*	\$90.00/ea
JOR4148	3.5mm i.d. 2.7 for screw: 3.5mm Self-Tapping JOR406a-o*	\$86.00/ea
JOR414G	4.5mm i.d. 3.2 for screw: 4.5mm Cortical Screw JOR426a-L plus Drill Sleeve JOR414f	\$105.00/ea
JOR414F	6.5mm i.d. 4.5 for use with Drill Guide JOR414e	\$105.00/ea

We do not stock all Orthopedic Products. Note that Jorvet/Jorgensen brand Products have a \$10 Dropship fee, as well as extra overnight fees.

13822 WEST BOULTON BLVD. METAWA, IL 60045

WWW.SHOPMEDVET.COM

Phone 800-544-7521

256

Fax 800-204-2177



TTA Products

Jorvet TTA Plate Bender

JOR1072B \$156.00/ea

JorVet
BUY NOW

Jorvet TTA Drill Guide

JOR1072C \$216.00/ea



Jorvet 1.9mm Pins for TTA

JOR1072D (set of 2) \$33.00/pr



Jorvet TTA Fork Holder

JOR1072E \$170.00/ea

Jorvet TTA Spreader w/ 6,9 & 12mm Inserts

JOR1072F \$316.00/ea

TTA Stainless Steel Instrument Kit

JOR1072K \$1,390.00/ea

Jorvet TTA Cage

BUY NOW



JOR1072JA	6 X 16 Stainless Steel	\$76.00/ea
JOR1072JAT	6 X 16 Titanium	\$95.00/ea
JOR1072JB	6 X 19 Stainless Steel	\$76.00/ea
JOR1072JBT	6 X 19 Titanium	\$95.00/ea
JOR1072JC	6 X 22 Stainless Steel	\$76.00/ea
JOR1072JCT	6 X 22 Titanium	\$95.00/ea
JOR1072KA	9 X 19 Stainless Steel	\$95.00/ea
JOR1072KAT	9 X 19 Titanium	\$106.00/ea
JOR1072KB	9 X 22 Stainless Steel	\$95.00/ea
JOR1072KBT	9 X 22 Titanium	\$106.00/ea
JOR1072KC	9 X 25 Stainless Steel	\$95.00/ea
JOR1072KCT	9 X 25 Titanium	\$106.00/ea
JOR1072MA	12 X 22 Stainless Steel	\$106.00/ea
JOR1072MAT	12 X 22 Titanium	\$115.00/ea
JOR1072MB	12 X 25 Stainless Steel	\$106.00/ea
JOR1072MBT	12 X 25 Titanium	\$112.00/ea
JOR1072MC	12 X 28 Stainless Steel	\$106.00/ea
JOR1072MCT	12 X 28 Titanium	\$115.00/ea



Stainless Steel Case for TTA Equipment

JOR1072Q \$140.00/ea

BUY NOW

Silicone Insert for JOR1072Q

JOR1072R \$75.00/ea

BUY NOW



TTA Screw Box

JOR1072SB \$200.00/ea

BUY NOW

TTA System Pilot Drill - 2.4 System

JOR372CH 2.5mm drill bit hard \$39.00/ea

JOR372CP 1.8mm pilot for 2.4 system \$37.00/ea



BUY NOW

Box & Silicone Insert for TTA Equipment

JOR1072BS \$290.00/ea



BUY NOW

Cruciate Repair Kit TTA

JOR1072 2.4 clear drill for 2.4 system \$3,720.00/ea

BUY NOW



TTA Cruciate Repair Kit

JOR1072T \$4,750.00/ea

BUY NOW

TTA Instrument Kit-Titanium

JOR1072TK \$1,500.00/ea

BUY NOW



TTA 2.4 Cross Head Screw Driver

JOR412CH \$148.00/ea

BUY NOW

Fork 3 prong Titanium

JOR1072PAT \$39.00/ea

BUY NOW

Fork 3 Prong

JOR1072PA \$39.00/ea

BUY NOW

Fork 4-Prong

JOR1072PB \$39.00/ea

BUY NOW

Fork 4-Prong Titanium

JOR1072PBT \$39.00/ea

BUY NOW

Fork 5-Prong Titanium

JOR1072PCT \$52.50/ea

BUY NOW

Fork 5-Prong

JOR1072PC \$39.00/ea

BUY NOW

Fork 6-Prong

JOR1072PD \$52.50/ea

BUY NOW

Fork 6-Prong Titanium

JOR1072PDT \$52.50/ea

BUY NOW

Fork 7-Prong

JOR1072PE \$52.50/ea

BUY NOW

Fork 7-Prong Titanium

JOR1072PET \$52.50/ea

BUY NOW

Fork 8-Prong

JOR1072PF \$52.50/ea

BUY NOW



We do not stock all Orthopedic Products. Note that Jorvet/Jorgensen brand Products have a \$10 Dropship fee, as well as extra overnight fees.

13822 WEST BOULTON BLVD. METAWA, IL 60045

WWW.SHOPMEDVET.COM

Phone 800-544-7521

257

Fax 800-204-2177

Orthopedic Products

Orthopedic Drills & Accessories

Makita Orthopedic Drill Set

A power driver with features making it the best on the market.

The power source is a high quality cordless reversible Makita driver drill.

- Variable-speed 0-600 RPM vs. Standard model which has 100 or 200 RPM settings.
- No skating effect at start, when drill may skid or jump • 3 1/2" cannulated extension with 1/4" Jacobs chuck
- Extension and chuck can be autoclaved separately. The drill can be covered with an autoclaved shroud (order separately).

JOR238M 8 1/4"L, 2.2 lbs. \$350.00/ea

BUY NOW

Jorvet Drill Shroud

Autoclavable Drill Shroud with Velcro closure.

JOR238S \$13.50/ea

BUY NOW

Disposable Drill Shroud fits any size drill. Special material has impervious inner layer. Provides full fluid repellency; top side has adhesive strip.

Not Pictured

JOR238SD Disposable, Sterile, 5/pk. \$11.10/pk

Jorvet Small Jacobs Chuck

Lightweight blue anodized aluminum. 120g, 14cm.

- Much finer, more delicate, and less than half the weight of standard chucks
- Ideal for small dogs and cats when using "K" wires and small pins up to 5/32"
- Handle not slotted as JOR214L

JOR214 120g, 14cm \$192.00/dz

BUY NOW

Ortho Chuck Extension Only

JOR238D1 Extension Only \$60.00/ea

BUY NOW

Jacobs Pin Chuck

Unique design on the standard instrument for introducing bone pins. An open slot cut into the handle permits visibility of the pin resting in the chuck, saving time by allowing the surgeon to check pin depth without having to remove the chuck. The stainless steel Jacob's accepts K-wires as small as 0.035" and pins as large as 1/4". The handle and extension piece are lightweight, blue anodized aluminum alloy. Key and extension piece included.

JOR214L Jacobs Chuck, 10 1/2"L. \$195.00/ea

JOR214LD1 Short chuck & key \$112.00/ea

BUY NOW

Jorvet Orthopedic Punched Hole Gauge

For pre-drilling positive profile pins. Pre-drill with a bit slightly smaller than the pin shank.

JOR372M \$36.00/ea

BUY NOW

Bone Screw and Drill Bit Gauge

Bone Screw and Drill Bit Gauge. (Metric)

JOR372P (Metric) \$27.00/ea

BUY NOW



JOR238M



JOR238D1



JOR214



JOR238D1D

JOR214L



JOR238S

Jorvet-Aesculap Saw Blades

Lightweight with less vibration. Provides high visibility of osteotomy site.

JOR238S824 Radius 24mm \$445.00/ea

JOR238S830 Radius 30mm \$445.00/ea



NEW

We do not stock all Orthopedic Products. Note that Jorvet/Jorgensen brand Products have a \$10 Dropship fee, as well as extra overnight fees.

13822 WEST BOULTON BLVD. METTAWA, IL 60045

WWW.SHOPMEDVET.COM

Phone 800-544-7521

258

Fax 800-204-2177

Orthopedic Products

Cast Cutters and Cruciate Repair

Cast Cutter & Accessories



Designed with multiple attachments that allow for a wide range of orthopedic procedures, as well as cast removal. The oscillating head permits delicate work or more aggressive cutting as needed.

Suggested procedures:

- Femoral head excision
- Triple Pelvic Osteotomy TPO
- Amputations
- Trochlear wedge osteotomy
- Necropsy
- Cast removal
- Tibial wedge osteotomy
- Saw specifications:
- Oscillations: 14,500/min.
- 9.6V, includes 110V charger and battery



JOR866

BUY NOW

JOR866	Power Saw w/ 2 Blades	\$478.00/ea
JOR866A	Cast Cutter Blade	\$95.00/ea
JOR866B	Sagittal Blade 12 x 7 x 1.2mm	\$91.00/ea
JOR866C	Sagittal Blade 9 x 12 x 45mm	\$91.00/ea
JOR866D1	Battery for power saw	\$238.00/ea
JOR866D2	110V charger for saw	\$147.00/ea
JOR866E	Extension piece for blade	\$193.00/ea
JOR866K	Complete kit	\$772.00/ea
JOR866S	Cloth Shroud	\$32.50/ea

Stryker Saw adaptor - use w/multi blades

JOR866Y \$212.00/ea

BUY NOW



JOR866Y

JOR866B



JOR866S



JOR866F



JOR866E



JOR866C

Cast Cutter Blades

BUY NOW

JOR866F	Saw blades 0.8mm thick 19.5mm w	\$94.00/ea
JOR866G	Saw blades 0.8mm thick 9mm w	\$92.00/ea
JOR866V	Power saw w/2 blades 220 volt	\$525.00

Engel Cast Cutter

BUY NOW

Engel Cast Cutter. Stainless steel blade. 5 3/4".

JOR94 Stainless steel blade, 5 3/4". \$19.50/ea

Beeson Cast Spreader

BUY NOW

Beeson Cast Spreader. Stainless steel. 12".

JOR94H Stainless steel. 12" \$39.00/ea

Cruciate Repair Crimping Forceps

Designed with a flattened area on the forcep jaws that crimps the metal tubes evenly without risk of cutting the nylon suture.

JOR710 7 1/2"L \$165.00/ea

BUY NOW



JOR710

Crimp Tube and Nylon "Ande" Leader Line Configurations

BUY NOW

Jorvet Crimp Tube only. Non-sterile.

BUY NOW

JOR710B 10mm Crimp Tube Only, For 50 lb. nylon leader line \$6.30/ea

Jorvet Crimp Tube with Nylon Line

BUY NOW

JOR710D 10mm Crimp Tube, Plus 500mm 50 lb., (0.7mm) nylon leader line. Tube and Nylon \$15.75/ea

JOR710CG 12mm Crimp Tube, Plus 800mm 100 lb., (1.0mm) nylon leader line. Tube and Nylon \$15.45/ea

JOR710C 12mm Crimp Tube, Plus 800mm 80 lb., (0.9mm) nylon leader line. Tube and Nylon \$15.75/ea

Nylon Line Only

BUY NOW

JOR710F 500mm 50 lb. Nylon Leader Line Only. \$6.90/ea

JOR710G 800mm 100 lb. Nylon Leader Line Only. \$6.60/ea

JOR710E 800mm 80 lb. Nylon Leader Line Only. \$6.75/ea



Correct - three evenly spaced crimps.

Incorrect - not enough crimps.

Incorrect - crimps too close to the end of the tube.



JOR710A-B



JOR710EB

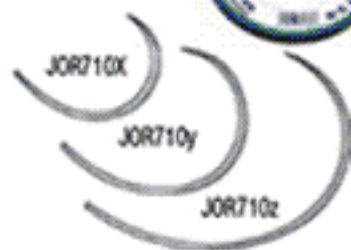

JOR710X

JOR710y

JOR710z

Bulk Nylon Line Only, Non-Sterile.

BUY NOW

JOR710EB 80 lb. Nylon Leader Line. 50 yds. Reel, Bulk Nylon Line Only, Non-Sterile \$21.00/ea

JOR710GB 100 lb. Nylon Leader Line. 50 yds. reel, Non-Sterile \$24.00/ea

JOR710FB 50 lb. Nylon Leader Line. 50 yd. Reel, Bulk Nylon Line Only, Non-Sterile \$19.50/ea

Cruciate Needle

BUY NOW



Swaged onto nylon suture. Includes crimp tube. Sterile

JOR710K 15mm X-Small Cruciate Needle. Swaged onto 50 lb. nylon leader line with 10mm crimp tube. 500mm L \$13.50/ea

JOR710M 20mm Small Cruciate Needle. Swaged onto 80 lb. nylon leader line with 12mm crimp tube. 800mm L \$13.50/ea

JOR710P 25mm Medium Cruciate Needle. Swaged onto 100 lb. nylon leader line with 12mm crimp tube. 800mm L \$13.50/ea

We do not stock all Orthopedic Products. Note that Jorvet/Jorgensen brand Products have a \$10 Dropship fee, as well as extra overnight fees.

13822 WEST BOULTON BLVD. METAWA, IL 60045

WWW.SHOPMEDVET.COM

Phone 800-544-7521

259

Fax 800-204-2177

Pin Cutter, Drill Accessories & Goniometer



Bone Pin Counter Punch

BUY NOW

Useful for tapping in exposed cut ends of small bone pins. Knurled handle. Stainless steel. 135mm length.

JOR215 \$52.00/ea



JorVet

Hex Screw-Driver

BUY NOW

Screwdrivers with screwholding sleeves hold the screw until it has engaged in the threaded hole. The sleeve slides back up the shaft to release the screw without disengaging it.

JOR412C	for 4.5mm/6.5 mm screws	\$108.00/ea
JOR412A	for 2.0mm screws, w/sleeve	\$112.00/ea
JOR412B	for 2.7/3.5/4.0 screws, w/sleeve	\$112.00/ea

Sleeves

JOR412AS	Sleeve for JOR412A, w/sleeve	\$93.00/ea
JOR412BS	Sleeve for JOR412B	\$90.00/ea
JOR412CS	Sleeve for JOR412C	\$90.00/ea

JorVet



Depth Gauge

BUY NOW

Accurate measurement of hole depth is essential to select the appropriate screw size. A range of gauges is available for the various screw sizes. Hole depth is read from the instrument. Remember to add plate thickness if necessary.

JOR410	for 2.7-4.0mm screws. Range 6-40mm.	\$200.00/ea
JOR410A	for 2.0mm screws. Range 6-20mm.	\$202.00/ea

Fixation Pins Positive

Threaded Portion at End of Pin

BUY NOW

Positive or raised thread pins have threads extending above the smooth shaft on a portion of the pin. The positive threaded pins have a tougher pull-out resistance and are the external fixation pins used almost exclusively in human orthopedics. There are two choices of pin styles and three different sizes.

1. Threaded portion is in mid-shaft
 2. Threaded portion is at the end of the pin
- All pins are 316LVM implant quality stainless steel.

JOR371F	Small. Shaft 3/32" dia., Thread 1/8" dia., Thread Pitch 1"L, Total 4"L, Thread Pitch 0.9mm	\$13.50/ea
JOR371G	Medium. Shaft 1/8" dia., Thread 5/32" dia., Thread Part 1 1/4"L, Total 4 1/2"L, Thread Pitch 0.9mm	\$13.50/ea
JOR371H	Large. Shaft 5/32" dia., Thread 3/16" dia., Thread Port 1 1/2"L, Total 6"L, Thread Pitch 0.9mm	\$15.10/ea



Goniometer Plastic 360

BUY NOW

The goniometer can be used for the calculation of tibial plateau angles, wedge resections, angles of anteversion plus others. It also can be used to measure pre- and post-op range of motion to evaluate post-op physiotherapy. White background assures ease of seeing number on any color dog.

JOR752P Medium for dogs over 60lbs. 6" (15 cm) \$18.00/ea

Jorvet Goniometer

BUY NOW

Canine Rehab Goniometer 5m

JOR752M	Small for dogs under 16lbs	\$27.50/ea
JOR752	Large	\$99.00/ea



Adjustable Drill Guide

JorVet

Designed to ensure accurate positioning of drill holes prior to inserting screws or prostheses. The pointed end is placed at the desired destination for the drill bit. The body of the device is tightened at the point of entry. Device includes 3 drill sleeves: 3.5mm, 2.5mm, and 2.0mm.

JOR414H	3.5mm, 2.5mm and 2.0mm sleeves.	\$260.00/ea
JOR414HL	4.5mm sleeve.	\$191.00/ea
JOR414HX	for use with JOR414HL, 5.5mm sleeve (equine) 13cm length spread.	\$68.00/ea

BUY NOW



Load/Neutral Drill Guide

To exert compression at a fracture site, the pilot bit must be positioned precisely in the slot in the compression plate. The load/neutral drill guide has two sleeves, one for compression (load) and one where no compression is exerted (neutral). There is one combined guide for each screw size.

BUY NOW

JOR411	for 2.4mm plate and 1.8mm pilot hole bit.	\$270.00/ea
JOR411B	for 2.7mm plates. Uses 2.0mm pilot hole drill bit.	\$336.00/ea
JOR411C	for 3.5mm plates. Uses 2.5mm pilot hole drill bit.	\$330.00/ea
JOR411D	for 4.5mm plates. Uses 3.2mm pilot hole drill bit.	\$330.00/ea

We do not stock all Orthopedic Products. Note that Jorvet/Jorgensen brand Products have a \$10 Dropship fee, as well as extra overnight fees.

13822 WEST BOULTON BLVD. METAWA, IL 60045

WWW.SHOPMEDVET.COM

Phone 800-544-7521

260

Fax 800-204-2177

CCL Lateral Suture



Jorvet CCL Lateral Suture System Double Swaged-On Line and Needle.

Some CCL deficient patients benefit from the use of double sutures. This is particularly true of very large dogs and 100 lb line. Passing a second needle behind the fabella risks damaging the first line and the peri-fabellar structures which ultimately will hold the nylon sutures. Double line, Swaged-on sutures allow the placement of two lines with one pass of the needle. Available as single sterile packs with or without crimps. The double line is supplied Swaged on as a loop and will, therefore, be of interest to those surgeons using the self-locking McKee/Miller knot (VCOT 1999/12-78-80)

Jorvet Double Line and Needle

BUY NOW

Without crimp tube

JOR710KD	500mm x 2 Line, 50 lb. / X-Small Needle	\$9.00/ea
JOR710MD	800mm x 2 Line, 80 lb./Small Needle	\$9.00/ea
JOR710PD	800mm x 2 Line, 100 lb./Medium Needle	\$8.10/ea

Jorvet Double Line, Needle and Crimps

JOR710KE	500mm x 2 Line, 50 lb. / X-Small Needle, Plus 10mm Crimps.	\$19.50/ea
JOR710PE	800mm x 2 Line, 100 lb. / Medium Needle, Plus 12mm Crimps.	\$19.50/ea
JOR710ME	800mm x 2 Line, 80 lb. / Small Needle, Plus 12mm Crimps.	\$20.25/ea

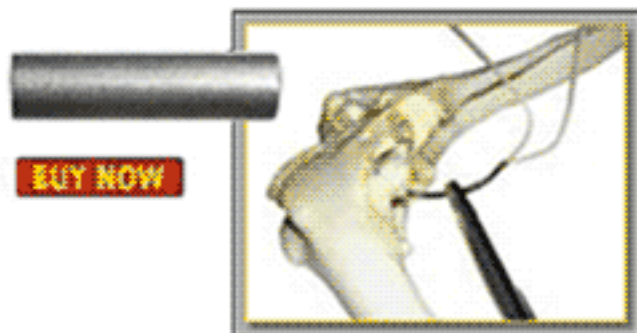

BUY NOW

Jorvet Mason Nylon Line

BUY NOW

Mason nylon line 100yd spools.

JOR714	20lb, 100 yds	\$28.50/ea
JOR714A	40lb	\$42.00/ea
JOR714B	60lb	\$63.00/ea
JOR714C	80lb	\$75.00/ea
JOR714D	100lb	\$88.00/ea



Jorvet Cruciate Suture Needle

BUY NOW

Cruciate Suture Needle. Designed for use with heavy nylon in the lateral suture repair method for cranial cruciate ruptures. Needles are specially curved along with a heavier body, making passage around the femur/fabella area much easier. Stainless steel.

JOR710XA	Small, 6/pk	\$264.00/ea
----------	-------------	-------------

Jorvet Cruciate Suture Needle

BUY NOW

Cruciate Suture Needle. Designed for use with heavy nylon in the lateral suture repair method for cranial cruciate ruptures. Needles are specially curved along with a heavier body, making passage around the femur/fabella area much easier. Stainless steel.

JOR710W	X-Small, 15mm dia, 6/pk.	\$8.10/pk
JOR710XA	Small, 6/pk	\$355.00/ea
JOR710Y	Medium, 6/pk	\$8.70/pk
JOR710Z	Large, 6/pk	\$8.70/pk



Jorvet Meniscus Probe

Visualization of the caudal horns of the meniscus can be a challenge. Often the process of exposing the caudal horn can result in distortions. A normal meniscus can look damaged or a "bucket handle" tear can sit back and look normal. It is helpful to gently probe the meniscus to establish its true condition. Dimensions refer to length of tip. Use 1mm in dogs <30kg and for dogs >30kg use a 2mm.

JOR710N	2mm (nerve hook) Probe	\$23.50/ea
JOR710NA	1mm Probe	\$21.00/ea



Mason Line Crimp Tubes

BUY NOW

These crimp tubes are specifically designed to be compatible with Mason brand of nylon line also used in the Securos® brand crimp tube range. All stainless implants grade with polished seamless tubing. Mason line swaged on various special sterile cruciate needles.

JOR1070	40# crimp tube 15pk	\$60.00/pk
JOR1070A	80# crimp tube 15pk	\$60.00/pk
JOR1070B	100# crimp tube 15pk	\$60.00/pk



Mason line swaged on various special sterile cruciate needles.

BUY NOW

JOR1070KA	40lb nylon with medium cruciate needle	\$57.00/pk
JOR1070KB	40lb double nylon line with medium cruciate needle	\$57.00/pk
JOR1070KC	40lb double nylon line with small cruciate needle	\$57.00/pk
JOR1070M	80lb nylon with large cruciate needle	\$57.00/pk
JOR1070MB	80lb nylon with small cruciate needle	\$57.00/pk
JOR1070MD	80lb double nylon line with medium needle	\$57.00/pk
JOR1070ME	80lb double nylon line with large needle	\$57.00/pk
JOR1070MF	80lb double nylon line with small needle	\$57.00/pk

We do not stock all Orthopedic Products. Note that Jorvet/Jorgensen brand Products have a \$10 Dropship fee, as well as extra overnight fees.

13822 WEST BOULTON BLVD. METAWA, IL 60045

Phone 800-544-7521

261

WWW.SHOPMEDVET.COM

Fax 800-204-2177



CCL Suture System & Liga Fiba

Jorvet CCL Suture System Starter Kit

JOR710SA • Crimping forceps \$240.00/ea

- 2 pkg. of each (3) different sized cruciate needles swaged onto nylon line and crimp tubes. Sterile. (6 total) (implants for 6 procedures)
- Procedure instructions on CD-ROM

BUY NOW

Jorvet

JOR710S Cruciate Repair Starter Kit \$395.00/ea



Jorvet Tensioning Clamp

These small stainless steel clamps feature knurled knobs that lock onto the nylon suture. After that, they are attached to a standard Gelpi or Weilbauer retractor and tension applied to the proper level. No need to throw away crimp tubes or purchase expensive tensioning instruments.

JOR710R Pair \$54.00/pr

Jorvet

Heavy-Duty Needle Driver

Tungsten carbide jaws. Especially designed to grip cruciate needle and ease passage around tough fabella tissue. 7" L.

JOR710Q 7" L \$68.00/ea

Cruciate Repair CD/Rom

Complete procedure available at nominal cost.

JOR710V FREE with CCL Suture System Starter Kit

Compound Action Crimper

JOR710X 7 1/2" \$8.70/pk



BUY NOW

Graft Passer with Small Eye

Instrument with handle and thin 3cm radius curved tip with small eye. The small eye will hold the large nylon suture used in cruciate repair. The curved end is used to access tight areas (i.e., between the fabella and femoral condyle).

JOR236SE 6" L, Stainless Steel \$95.00/ea

BUY NOW

Jorvet

Bone Tunnel Borer

The borer is a small handle with an attached drill bit. This hand instrument is used to create a bone tunnel quickly and easily without having to set up a complete orthopedic drill (i.e., CCL repair through tibial tuberosity). Stainless steel. 18cm.

JOR236T 2.7mm \$81.00/ea
JOR236TC w/Counter Sink \$102.00/ea

BUY NOW

Jorvet

Jorvet LigaFiba Braided Polyethylene Fiber (Material Only)

BUY NOW

Monofilament nylon has been the standard suture material for the lateral suture technique for repair of CCL damage. Newer materials are made of braided polyethylene fiber and offer several advantages over nylon.

- Significantly stronger (up to 15 times)
- Better flex fatigue resistance and abrasion
- Knots tie easier This makes LigaFiba suture material an ideal material for ligament and tendon repair. Its available packages are:
- LigaFiba suture material only
- Provided with attached cruciate needle and straight needle
- LigaFiba with toggle buttons in bone tunnel procedures in both cruciate and hip repairs



JOR444A	150 lb test X 500mm length	\$15.00/ea
JOR444B	250lb. Test x 600mm sterile	\$17.50/ea
JOR444C	500 lb test X 600mm length	\$20.00/ea

Jorvet LigaFiba Lateral Suture

BUY NOW

LigaFiba lateral suture with swaged on needles one end has attached cruciate needle for fabella ligament passage. The other end a straight needle for passing through tibial crest. The LigaFiba ties easily but also can be crimped (require Jorvet fiber crimper instrument JOR710x) and Jorvet fiber crimp JOR448a. Sterile package.

JOR444D	20lb w/needles	\$31.50/ea
JOR444E	500lb w/needles	\$31.50/ea

Jorvet

Jorvet LigaFiba ISO Toggle Suture

BUY NOW

A newer technique for extra capsular repair of CCL damage uses a bone tunnel between iso metric point on the femur. A set of small toggles are used instead of passage through the fabella ligament. The LigaFiba is passed through the bone tunnel with an attached straight needle. Step by step guidelines available The LigaFiba can be readily tied by the toggle button. Step by step guidelines available. The LigaFiba can be readily tied by the toggle button

JOR444F 250 lb test (dogs up to 50lbs) Bone tunnel use JOR372cx, 2.5mm drill \$88.00/ea

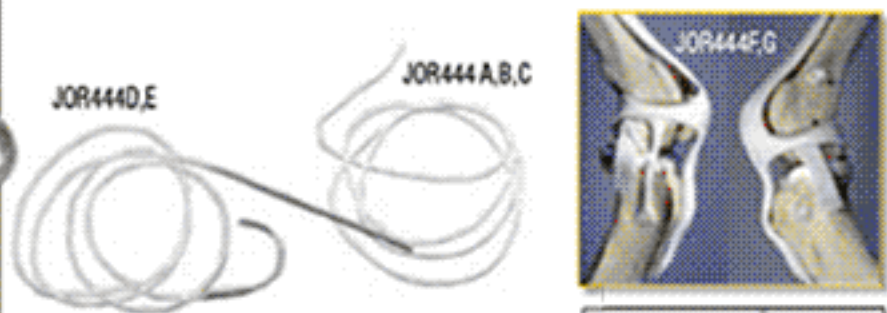

Graft Passer with Small Eye

Instrument with handle and thin 3cm radius curved tip with small eye. The small eye will hold the large nylon suture used in cruciate repair. The curved end is used to access tight areas (i.e., between the fabella and femoral condyle).

JOR236SE 6" L, Stainless Steel \$95.00/ea

BUY NOW

Jorvet

Bone Tunnel Borer

The borer is a small handle with an attached drill bit. This hand instrument is used to create a bone tunnel quickly and easily without having to set up a complete orthopedic drill (i.e., CCL repair through tibial tuberosity). Stainless steel. 18cm.

JOR236T 2.7mm \$81.00/ea
JOR236TC w/Counter Sink \$102.00/ea

BUY NOW

Jorvet

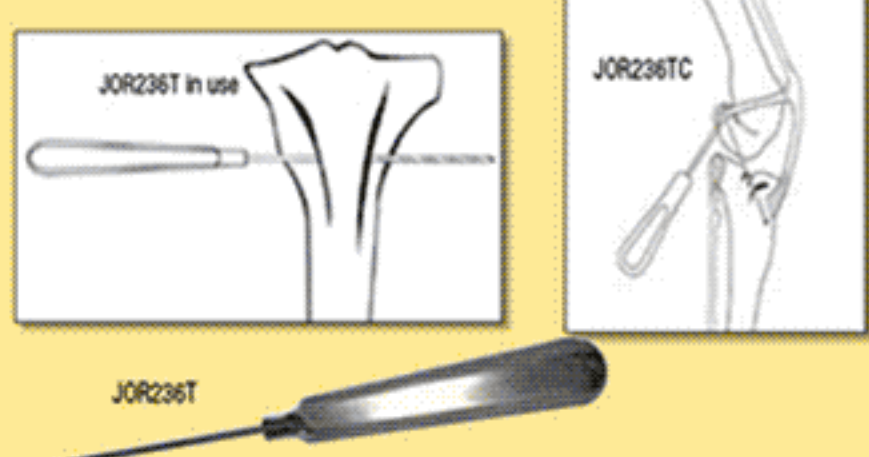

We do not stock all Orthopedic Products. Note that Jorvet/Jorgensen brand Products have a \$10 Dropship fee, as well as extra overnight fees.

13822 WEST BOULTON BLVD. METAWA, IL 60045

WWW.SHOPMEDVET.COM

Phone 800-544-7521

262

Fax 800-204-2177

Orthopedic Products

Hohman Retractors, Graft Passer & Meniscus Clamp

Hohman Retractor

Greatly improve exposure and access in the small surgical field of joint surgery. Stainless steel.

JOR235A	12mm W x 24cm L (9"). Medium breeds	\$67.00/ea
JOR235B	18mm W x 24cm L (9 1/2"). Large breeds	\$61.00/ea
JOR235C	8mm	\$61.00/ea



BUY NOW

Mini Hohman Retractor

Greatly improve exposure and access in the small surgical field of joint surgery. Stainless steel.

JOR235M	6mm x 16cm	\$46.50/ea
---------	------------	------------

BUY NOW



JOR235M

Super Mini 4mm Hohman Retractor

JOR235MA	4mm	\$62.00/ea
----------	-----	------------

BUY NOW

Stainless Steel Spike Washer

Used for ligament attachment or fixation to spread load or retain wire or sutures. Autoclavable.

JOR375WC	for use with 2.7mm screw	\$11.10/ea
JOR375WD	for use with 3.5mm screw	\$14.40/ea
JOR375WE	for use with 4.5mm screw	\$15.00/ea



BUY NOW



Duck-Billed Mini-Rongeur

This X-small rongeur was designed specifically for use in delicate spinal cord surgery. It is especially effective in removing the final layer of bone overlying the spinal cord in laminectomy procedures. Stainless Steel.

JOR224	2mm bite, 5 1/4"	\$134.00/ea
--------	------------------	-------------

BUY NOW



Ecklin-Duckbill Rongeur

Double action. 3mm bite, 8 1/2".

JOR225E	Double action, 3mm bite, 8 1/2".	\$196.00
---------	----------------------------------	----------

BUY NOW



Jorvet Stifle Lever



BUY NOW

Examination and management of meniscal injuries is made extremely difficult by the limited access to the medial meniscus during routine approaches. Exposure of the medial meniscus is typically achieved by either use of a stifle distractor or by a Hohman retractor. Hohman retractors are not designed for levering against articular cartilage in that the blade does not "fit" the trochlea. The stifle lever is designed to substitute the Hohman. The caudal surface of the stifle lever is contoured to fit the trochlea of large dogs. The load is dissipated over a large area minimizing trauma. The ring style handle is convenient for retraction by the surgeon using the thumb. The tip atraumatically hooks behind the caudal aspect of the tibial plateau.

JOR235S	9" (225mm) length.	\$61.00/ea
---------	--------------------	------------

Jorvet Curved Graft Passer

Used in anterior cruciate repairs such as the "over the top procedure." Using the Graft Passer lessens the risk of damage to joint surfaces and ancillary structures. Stainless steel.

JOR236XS	X-Small, 2.0cm dia. head.	\$106.00/ea
----------	---------------------------	-------------

BUY NOW



Jorvet Graft Passer with Small Eye

Instrument with handle and thin 3cm radius curved tip with small eye. The small eye will hold the large nylon suture used in cruciate repair. The curved end is used to access tight areas (i.e., between the fabella and femoral condyle).

JOR236SE	6"L., Stainless Steel	\$95.00/ea
----------	-----------------------	------------

BUY NOW



Micro Tooth Meniscus Clamp

Management of meniscal injuries is very important. In medium and small dogs space limits access. The toothed minimeniscus forceps are designed to grasp damaged meniscus tissue to facilitate removal using micro blades.

JOR236H	The toothed minimeniscus forceps are designed to grasp damaged meniscus tissue to facilitate removal using micro blades.	\$36.00/ea
---------	--	------------

BUY NOW



Jorvet Meniscus Knife

A specially-designed knife for use in the limited space of the canine stifle.

JOR236M	15cm	\$102.00/ea
---------	------	-------------

BUY NOW

JOR236M



Double Loop Cerclage Wire Tightener

Cerclage wire tightener with two tightening knobs for double loop eyed wire. Fiber handle

1. Use single tightener for single wire
2. Use both tighteners for double loops

JOR218LD	\$140.00/ea
----------	-------------

BUY NOW

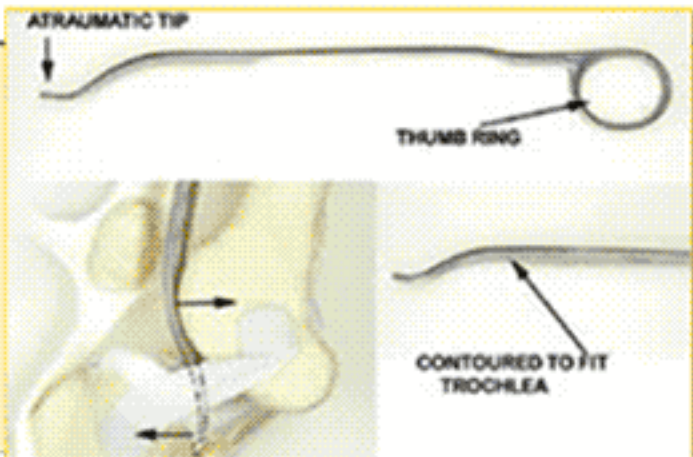

We do not stock all Orthopedic Products. Note that Jorvet/Jorgensen brand Products have a \$10 Dropship fee, as well as extra overnight fees.

13822 WEST BOULTON BLVD. METAWA, IL 60045

WWW.SHOPMEDVET.COM

Phone 800-544-7521

263

Fax 800-204-2177

Miscellaneous

Bone Wax

This natural wax will control the seepage of blood from cut/cancellous bone, which obscures the visual field. The wax acts as a physical barrier.

BUY NOW



JOR9120 This natural wax will control the seepage of blood from cut/cancellous bone, which obscures the visual field. The wax acts as a physical barrier. \$56.00/dz

Autoclavable cases

JOR429C 3.5mm, 2.5mm, and 2.0mm \$230.00/ea

BUY NOW

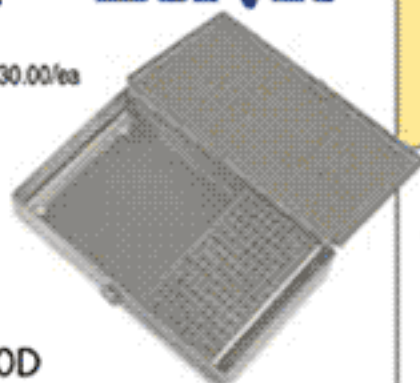

Bone Screw Rack Only

JOR429D2 Rack for JOR429 \$110.00/ea

Bone Screw Rack for JOR430D

JOR430D2M for JOR430D \$120.00/ea

Jorvet Cerclage Wire Passer

This is a simple instrument for passage of cerclage wire around fracture sites. Stainless steel. 15cm.

- Minimizes trauma to surrounding tissue
- Saves surgical time
- Double-ended for a whole range of bone sizes

JOR217 \$42.00/ea

BUY NOW



Cannulated Luer Lock

JOR343 16mm \$275.00/ea

Plate 3-Hole SS

JOR1072NA \$39.00/ea

Plate 3-Hole Titanium

JOR1072NAT \$45.00/ea

Plate 4-Hole SS

JOR1072NB \$39.00/ea

Plate 4-Hole Titanium

JOR1072NBT \$45.00/ea

Plate 5-Hole SS

JOR1072NC \$39.00/ea

Plate 5-Hole Titanium

JOR1072NCT \$45.00/ea

Plate 6-Hole SS

JOR1072ND \$51.00/ea

Plate 6-Hole Titanium

JOR1072NDT \$60.00/ea

Plate 7-Hole SS

JOR1072NE \$52.50/ea

Plate 7-Hole Titanium

JOR1072NET \$60.00/ea

Plate 8-Hole SS

JOR1072NF \$52.50/ea

Plate 8-Hole Titanium

JOR1072NFT \$60.00/ea

BUY NOW

Bone Washer

Plain bone washers. Stainless steel. JOR375F-JOR375H

JOR375F Plain Washer 1.5/2.0/2.2mm screw \$5.95/ea

JOR375G Plain Washer 2.7mm/3.5mm/4.0mm screw \$5.95/ea

JOR375H Plain Washer 4.5mm screw \$8.65/ea

BUY NOW



Stainless Steel case w/Screw Rack

Stainless Steel Case with screw rack.

JOR429CS \$325.00/ea **BUY NOW**

Jorvet Stifle Retractor **BUY NOW**

The examination of the meniscus and intraarticular structure during anterior cruciate repair is a real necessity. This visualization often is difficult even in the largest of dogs. The stifle retractor allows gentle retraction between the femur and tibia, exposing the entire stifle joint to a thorough exam without damaging the joint surface. Stainless steel.

JOR240W \$210.00/ea

JOR240WB (<50 Kg), X-Small \$158.00/ea

JOR240WS Wallace \$135.00/ea



Modified Stifle Retractor

Designed for medium and large dogs (the group with the highest incidence of meniscal damage), this improved model has longer jaw tips which are self protecting when the instrument is in the closed position. Once inserted atraumatically into the stifle, distraction exposes the longer tips for maximum grip. The best instrument to examine the caudal horn of the medial meniscus.

JOR240WM (15-50 Kg), 7 1/2" \$213.00/ea



BUY NOW

Jorvet Small Stifle Retractor

5", 6mm profile. The small overlapping tips allow atraumatic entry into small arthrotomies and small stifles.

BUY NOW

JOR240WA (5-50 Kg) \$161.00/ea



Stifle Distractor w/Spinlock

The working tips or our spinlock are the same as the ratchet version. The spinlock offers more secure distraction as it is less likely to slip. The spinlock also offers an infinite range of position versus the ratchet.

JOR240WAS Small \$180.00/ea

JOR240WBS X-Small \$180.00/ea

BUY NOW



We do not stock all Orthopedic Products. Note that Jorvet/Jorgensen brand Products have a \$10 Dropship fee, as well as extra overnight fees.

Orthopedic Instruments



Small Fragment Forceps

BUY NOW

Single pointed reduction forceps typically applies pressure at the exact point where it is desirable to place an implant. Splitting the tips allows implants to be placed at the ideal position (e.g., repair of lateral condyle fractures).

JOR212S 5 1/4" \$122.00/ea

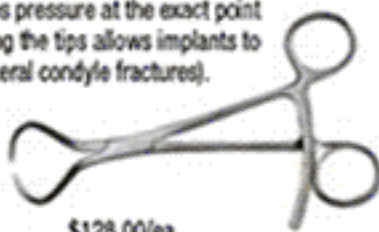

JOR212L Extra Large, 8". May be used to provide temporary stabilization of osteotomy while the plate is contoured and placed. \$128.00/ea

JOR212LS Large, Spin Lock Closure, 7 1/2" \$163.00/ea

JOR212M Medium, 135mm. \$119.00/ea

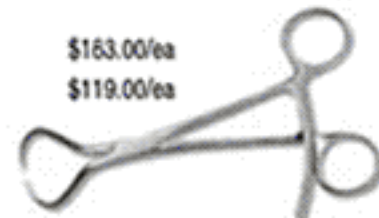

Esophageal Foreign Body Forceps

- One day you will need these!! An especially long forceps that can remove foreign bodies such as fish hooks or lodged bones from even the distal esophagus or trachea.
- Backward facing teeth for maximum grip
- shaft diameter small as possible to allow placement of endoscope alongside

BUY NOW

JOR212EFB 25cm shaft x 3.0mm diameter \$160.00/ea



Twin-Point Fragment Forceps

BUY NOW

Single pointed reduction forceps typically apply pressure at the exact point where it is desirable to place an implant. Splitting the tips allows implants to be placed at the ideal position (e.g., repair of lateral condyle fractures).

JOR212TC Curved Tip, 6 1/2" \$133.00/ea

JOR212TS Straight Tip, 6 1/2" \$123.00/ea

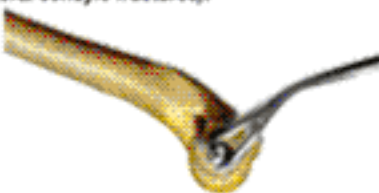

Bone Plate Holding Forceps

These forceps are designed to maintain plate position through a hole in the plate. The ball, just behind the point of the jaw, locates in bone plate screw hole causing minimal interference elsewhere in the operation site. Also, useful as a reduction forceps in soft young bone, as the balls prevent over-penetration of the bone.

BUY NOW

JOR212P 6" (15 cm). \$133.00/ea



Reduction Forceps with Spinlock

Spin lock. Provides incremental secure control, round ends.

JOR212GS Standard, 6" (15cm). \$110.00/ea

BUY NOW



Baby Kerns Bone Forceps

German made. Stainless steel. **Jorvet**

JOR159 15cm, 6" \$147.00/ea

JOR159L Standard, 8" (21cm) \$169.00/ea

BUY NOW



Mini Baby Kerns Bone Holding Forceps

JOR159M 10cm, 4" \$105.00/ea

BUY NOW

Jorvet Verbrugge Forceps

JOR213VA 6.5" \$192.00/ea

JOR213VB 9.5" \$226.00/ea

BUY NOW



Bone Holding Forcep

- For small dogs and cats
- Wide jaws offer maximum compression
- Bone screws and IM pins can be inserted through the center

JOR213 Stainless steel, 15 cm. 6" \$133.00/ea

BUY NOW



Pig OB Forcep

Danish model. These forceps open sideways, making it practically impossible to catch the uterine lining. The piglet is gently grasped either around the head or the hips. No need of inserting your hand to place the instrument.

JOR22 23" L. \$25.50/ea

BUY NOW



Condyle Clamp

An improvement over the old style rectangular plexi-glass condyle clamp. This triangular, stainless steel, two-sided clamp fits over the humeral condyles and allows greater alignment. A lag screw can be inserted through the hole in the middle of the triangular plate. Reduction may be checked by radiography prior to lag screw fixation. Pressure should be applied proximo-laterally not just purely laterally.

JOR213C \$106.00/ea

NEW

BUY NOW

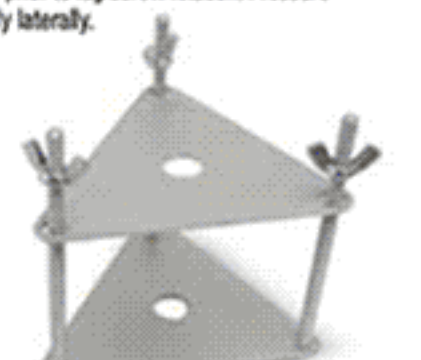

We do not stock all Orthopedic Products. Note that Jorvet/Jorgensen brand Products have a \$10 Dropship fee, as well as extra overnight fees.

13822 WEST BOULTON BLVD. METAWA, IL 60045

WWW.SHOPMEDVET.COM

Phone 800-544-7521

265

Fax 800-204-2177



Orthopedic Instruments

Jorvet Bone Plate Benders

BUY NOW

Proper contouring of bone plates is a necessity for proper reduction of fractures. Used in pairs, bone plate benders are the most cost-effective method of plate contouring. Stainless steel.

- JOR853 Small Bender. 1.5mm/2.0mm. Used for small 1.5/2.0mm plates. 140mm L. Pr/Pk. \$59.00/pr
 JOR853B Heavy Bender. 4.5mm. Used for 3.5mm broad and 4.5mm plates. 200mm L. Pr/Pk. \$82.00/pr



Jorvet Plate Bending Pliers

BUY NOW

Double-sided roller-type. Used for 3.5mm narrow, 3.5mm broad and 4.5mm narrow plates. Stainless steel with aluminum handles.

- JOR852 15" (380mm) L. \$307.00/ea



Jorvet Reconstruction Plate Pliers

Used for 3.5mm reconstruction plates. Stainless steel.

- JOR852A 290mm L. \$212.00/ea



BUY NOW

Plate Bending Pliers TPLO Guide Wire Bender

Also useful for bending guide pins for the TPLO technique. Stainless steel with satin finish.

Jorvet



BUY NOW

- JOR854X Contours 2.7/3.5mm narrow bone plates \$445.00/ea

Jorvet Bone Scriber

BUY NOW

- JOR822T \$32.00/ea



Leighton Bone Pin Introducer

designed to help reduce overriding fractures and facilitate insertion of the intramedullary pin into the distal segment of a fracture.

- JOR158 (see illustration for explanation of use) \$170.00/ea

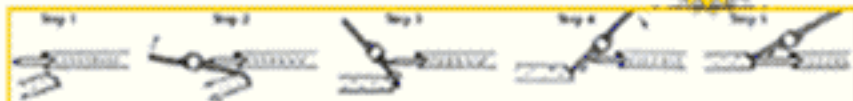

Jorvet Bone Toggle only

The toggle insertion process is commonly difficult due to use of home-made or other commercial devices. Typically problematic is the toggle coming back out of the hole in the acetabulum. The toggle insertion device deposits the toggle reliably and safely into the pelvic canal through the 4.5mm hole in the acetabulum. Pulling back on the LigaFiba while retaining the insertion device in the hole "flips" the toggle, preventing pullout. The LigaFiba line which passes through the hole in the toggle is passed down through the drilled hole in the femoral head and neck. Use of an adjustable drill guide (JOR414h) ensures accurate placement of this hole.

BUY NOW

- JOR863T Double-wrapped in sterile pouch with LigaFiba (JOR2001b) and button. \$43.00/ea



Jorvet Toggle Insertion Kit

BUY NOW

The hip toggle is a well-proven method of management of coxo-femoral luxations. A tunnel is drilled up through the femoral head and neck, plus through the acetabulum where the round ligament normally attaches. The toggle is placed through the acetabulum. It turns cross ways on the medial side of the pelvis. LigaFiba runs the length of the tunnel, and tension is applied to the toggle, keeping the hip in place.

- JOR863 Includes insertion device and one sterile toggle with 180 lb. LigaFiba (JOR2001b) and button. \$130.00/ea



OMROD Orthopedic Button

- JOR863X \$14.20/ea **BUY NOW**



Deluxe Bone Toggle Kit

Includes: JOR414H Drill Guide, JOR863 Toggle Insertion Kit with 1 toggle, JOR863T Insertion Toggles (5) with buttons and LigaFiba Line. Sterile. JOR863X Omrod Button.

- JOR863K Includes: JOR414H Drill Guide, JOR863 Toggle Insertion Kit with 1 toggle, JOR863T Insertion Toggles (5) with buttons and LigaFiba Line. Sterile. JOR863X Omrod Button. \$550.00/ea



NEW

BUY NOW

Buff's Corkscrew Trocar

Buff's Corkscrew Trocar with metal stylet.

- JOR40C \$21.50/ea **BUY NOW**



We do not stock all Orthopedic Products. Note that Jorvet/Jorgensen brand Products have a \$10 Dropship fee, as well as extra overnight fees.

Orthopedic Products

Curettes, Elevators & Ronguers

Volkman Bone Curette

BUY NOW

- JORGENSEN** JOR222A Excellent for OCD lesions. Oval cutting surface. German-made. Stainless steel. 22cm., #000 \$37.50/ea
- JORGENSEN** JOR222B Excellent for OCD lesions. Oval cutting surface. German-made. Stainless steel. 22cm., #2 \$37.50/ea

NEW

Hatt Spoon Curette

BUY NOW

An alternative to the disarticular in large dogs. The edge of the spoon is very sharp. A fiber handle for balance. 230mm (9.4") Oval shaped scoop.

- JOR222N 17mm x 30mm scoop \$73.00
- JOR222P 12mm x 18mm scoop \$73.00
- JOR222Q 7mm x 12mm scoop \$73.00

Jorvet House Curette

BUY NOW

- JOR222H 2.5mm + 3.0mm ends \$47.00/ea

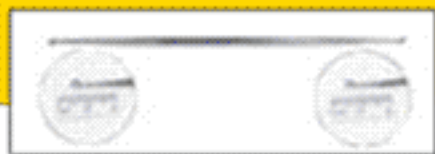

Key Periosteal Elevator

Slightly curved blade.

BUY NOW

- JOR226A German, Stainless Steel, 190mm. (7 1/2"), Blade, 6mm \$64.00/ea
- JOR226B German, Stainless Steel, 190mm. (7 1/2"), Blade, 12mm \$64.00/ea
- JOR226C German, Stainless Steel, 190mm. (7 1/2"), Blade, 19mm \$64.00/ea

Freer Elevator

Knurled double-ended elevator with curved fine spatula tips. Useful for lifting of tissue layers.

BUY NOW

- JOR226Q Stainless Steel, German, 7" (18cm). \$49.00/ea

Periosteal Elevator

A popular configuration available in 6mm curved tip. Lightweight fiber handle.

- JOR226R 180mm. (7 1/2"), Square 6mm tip \$63.50/ea
- JOR226S 180mm. (7 1/2"), Curved 6mm tip **BUY NOW** \$68.00/ea



Jorvet Ruskin Rongeur

BUY NOW

German-made. Stainless steel.

- JORGENSEN** JOR225C Curved, German, Stainless Steel, 4mm bite, 18cm (7") \$190.00/ea



Eqiune Dental Compound Rongeur

Large 6mm bite is used to aggressively remove pieces of tooth. They bite with a strong compound action. Also, useful to remove heavy plaque from teeth. Slight curved head.

- JOR225X 9" length \$110.00/ea

Jorvet

BUY NOW



Micro Friedman Rongeur Curved

- JORGENSEN** JOR224F Very delicate. 5 1/2" (14cm) Curved Jaw, 1.3mm W. \$102.00/ea

BUY NOW



Stille-Luer Rongeur

- JOR225L Curved. 8mm bite. 22cm (8 1/2") \$190.00/ea

Jorvet

BUY NOW



Laminectomy Rongeurs

- JOR225LRA 2mm x 16cm \$135.00/ea
- JOR225LRB 3mm x 16cm \$135.00/ea
- JOR225LRC 4mm x 16cm \$135.00/ea

BUY NOW



Liston Bone Cutting Forceps

Single action forceps

BUY NOW

- JORGENSEN** JOR223 German, Stainless Steel, 5 1/2". \$175.00/ea



We do not stock all Orthopedic Products. Note that Jorvet/Jorgensen brand Products have a \$10 Dropship fee, as well as extra overnight fees.

13822 WEST BOULTON BLVD. METAWA, IL 60045

WWW.SHOPMEDVET.COM

Phone 800-544-7521

267

Fax 800-204-2177



K-Wire & Bone Instruments

Jorvet Steel Stainless K-wire

BUY NOW

K-Wire or Fine Orthopedic Wire. Highest quality stainless steel type 316LVM. U.S.A. made. Double Trocar Point.

JOR250M	.035" X 7" 6/Pk	\$16.80/pk
JOR250N	.045" X 7" 6/Pk	\$17.40/pk
JOR250P	.062" X 7" 6/Pk	\$20.10/pk

NEW

Jorvet Steel Stainless K-Wire

BUY NOW

Highest quality stainless steel type 316LVM. U.S.A. made. Double Trocar Point.

JOR250MA	.035 x 7"	\$3.10/ea
JOR250NA	Single, .045 x 7"	\$3.00/ea
JOR250PA	.062 x 7", double point, single	\$3.10/ea

Jorvet Small Pin Vise

JOR214K 3 ft L holds small K-wires and pins up to 2.5mm (3/32") \$78.00/ea

BUY NOW

Jorvet K-Wire Cutter

JOR220BB Tungsten Carbide Inserts, \$210.00/ea
Cuts wire up to 2.2mm. 9"L.

BUY NOW

Jorvet Smaller K-wire/Small Pin Punch

JOR215A Small, 1.6mm fine tip. \$54.00/ea

BUY NOW

Jorvet

Jorvet Small Angles Bone Cutter

Especially useful for small dogs and cats. The jaws have the ideal size and angle for:

- Femoral head and neck excision
- Tibial crest translocation
- Many other small bone cutting procedures

JOR223S 15mm blade. 6 1/2" (170mm) length. \$125.00/ea

BUY NOW

Jorvet

Jorvet Bone Chisel

Striking button for easier use with Gerzog mallet. German-made.

JOR227A	Stainless Steel, 6mm, 17cm L (6 1/2")	\$54.00/ea
JOR227B	Stainless Steel, 12mm, 17cm L (6 1/2")	\$54.00/ea

NEW

BUY NOW

Jorvet

Orthopedic Distractor **Jorvet**

Can be used with ESF Pins 3.2-4.0mm. Distractors are useful instruments for the proper repositioning and compression of long bone fractures. The distractor will hold the bone in anatomical alignment and allow the placement of either bone plates, K-E external fixation devices, or bone screws. The instrument will greatly reduce the amount of manipulation that goes on when trying to maintain alignment during surgery, and allows the surgeons to concentrate their efforts on applying the proper fixation device.

JOR237 \$610.00/ea

BUY NOW

NEW



Stille Liston Bone Cutting Forceps

33-166B 10.5", Double Action 4mm jaw \$129.00/ea

BUY NOW

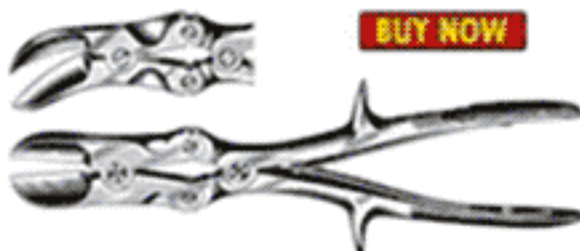

Gerzog Mallet

Hollow handle with 16 oz. lead-filled head. 25 x 35mm head. German-made. 18cm (7 1/4"). Stainless steel.

JOR228M 18cm (7 1/4"), German-made, Stainless steel. \$54.00/ea

BUY NOW



Jorgensen Osteotome **Jorvet**

JOR228A	Stainless Steel, 13.5cm (5"), Blade 10mm W	\$42.00/ea
JOR228B	Stainless Steel, 13.5cm (5"), Blade 16mm W	\$42.00/ea

BUY NOW



Jorvet Small Lowman Bone Clamp

Developed from standard human Lowman clamp. This clamp grips bone up to 15mm diameter and will also hold small plates in position.

JOR2130 3" (70mm) length. \$120.00/ea

BUY NOW



We do not stock all Orthopedic Products. Note that Jorvet/Jorgensen brand Products have a \$10 Dropship fee, as well as extra overnight fees.

13822 WEST BOULTON BLVD. METAWA, IL 60045

WWW.SHOPMEDVET.COM

268

Phone 800-544-7521

Fax 800-204-2177

Sterilization, Disinfectants & Cleaners

Iodine Scrub/Solution, Autoclave Tape & Sterilization Pouches

Povidone Iodine Scrub Solution

Generous foaming action helps loosen foreign matter on skin. Rinses easily, leaving no residue. Emollient formulation is soft and non-drying to the skin.

PVPSCR-G	1 Gallon	\$29.99/ea
PVPSCR-P	16oz	\$4.29/ea

BUY NOW



Povidone Iodine Solution

Prep solutions contain 10% weight by volume. Effective for skin and mucous membrane preparation prior to surgical prescrub. Solutions are antimicrobial solutions with surfactants, and contain 7.5% weight by volume Povidone Iodine, USP solution equivalent to 0.75% available iodine.

PVPSOL-G	1 Gallon	\$29.99/ea
PVPSOL-P	16oz	\$4.29/ea

BUY NOW



Surgery Sterilization Pack Wraps

These non-woven, soft but tough surgical wraps are useful for wrapping surgery packs during sterilization and storage. They can also be used for actual surgery drapes in pre-cut sizing. The green Sontara fabric is very durable but economical. It withstands steam sterilization for a superior barrier against air and water borne bacteria.

BUY NOW

JOR258A	18" x 18", 50pk	\$8.70/pk
JOR258B	24" x 24", 50pk	\$15.60/pk
JOR258C	30" x 30", 50pk	\$23.80/pk
JOR258D	36" x 36", 50pk	\$35.50/pk
JOR258E	45" x 45", 50pk	\$46.00/pk



Steam Indicator Strips

Shows a distinctive blue to black color change that is not reversible. Indicated for use in gravity and vacuum cycles

200100	4" 250/bx	\$7.95/bx
200150	8" 250/bx	\$12.95/bx

BUY NOW



Steam Autoclave Tape

BUY NOW

Sterilizer tape is placed on outside of bag or instrument wrap. Indicates when sterilization is complete. Available in 3 widths. Cut to size as needed.

AUTOTAPE1	1" x 60 yds	\$4.25/ea
AUTOTAPE1/2	1/2" x 60 yds	\$3.99/roll
AUTOTAPE3/4	3/4" x 60 yds	\$4.68/roll



Sterilization Tubing

BUY NOW

Deluxe sterilization rolls with gas/steam indicator. 100 Foot Rolls.

TUBE3	3" X 100'	\$7.95/ea
TUBE4	4" X 100'	\$9.95/ea
TUBE6	6" X 100'	\$11.95/ea



Jorvet Sterilization Tubing

Sterilization Tubing for sterile packaging of instruments. Cut off appropriate length from 100' roll. Blue-tinted side for visualization, other side paper-backed. Will work for either ethylene oxide or steam autoclaving.

JOR481A	2" x 100', 10 bx/cs	\$12.40/ea
JOR481B	3" x 100', 10 bx/cs	\$14.00/ea
JOR481C	4" x 100', 10 bx/cs	\$17.40/ea
JOR481D	6" x 100', 10 bx/cs	\$17.40/ea

BUY NOW

NEW



Sterilization Pouches

BUY NOW

Top quality sterilization pouches at low, low prices. Compare our prices to those of others and stock up now to save! Self-Sealing. 200 per box

442090	2 3/4" x 10", 200/bx	\$10.50/bx
442100	3 1/2" x 5 1/4", 200/bx	\$10.50/bx
442101	3 1/2" x 9", 200/bx	\$11.50/bx
442102	5 1/4" x 10", 200/Bx	\$16.50/bx
442103	7 1/2" X 13", 200/Bx	\$27.50/bx
442104	8" X 16", 200/Bx	\$29.95/bx



Sterilization Pouch

BUY NOW

Pre-formed pouches with self-adhering adhesive tape features one blue-tinted side for visualization of contents, with other side paper-backed. Will work with either steam autoclave or ethylene oxide gas sterilization.

JOR480A	3.5" x 10", 200-pack	\$23.25/ea
JOR480B	5.25" x 11", 200-pack	\$42.00/ea
JOR480C	7.375" x 13", 200-pack	\$54.50/ea



Sterilization Envelope

Sterilization Record Envelopes for Steam or Gas Loads Keep Data Organized. Med-Checks' pre-printed 9" x 12" (23cm x 30cm) envelopes are designed for storing Bowie Dick test sheets, recordings and other pertinent data.

MDS2009000	9x12" 200/cs	\$53.02/bx
------------	--------------	------------

BUY NOW

NEW





Instrument Cleaning

Instrument Brush

BUY NOW

- 40-200 Nylon \$1.80/ea
- 40-205 Stainless \$1.80/ea
- 40-210 Brass \$0.99/ea



Nylon Brush

BUY NOW

For proper cleaning of expensive surgical instruments. These brushes will remove all tissue residue and dried blood from hard to reach areas on surgical instruments.

JOR364 7" \$1.80/ea



Stainless Steel Brush

BUY NOW

Stainless Steel Bristle for burrs and rasps.

JOR364S \$1.80/ea



Double Sided Brush

NEW

Double-Sided Brush with both nylon and stainless steel bristles.

JOR364D \$2.25/ea

BUY NOW

Surgical Instrument Milk

An absolute necessity for lubricating and protecting expensive surgical instruments. Use after every cleaning to extend the life of all types of stainless steel surgical instruments. Contains a special additive which

- Dissolves organic debris that may build up in a box lock.
- Inhibits corrosion. Deposits anti-corrosive microfilm onto instrument surface
- Gentle ingredients. Formulated with non-aggressive and near neutral pH (7-8)
- 1 gallon makes 7 gallons of lubricant
- Available 4 gallons/case



JOR648 \$33.00/ea

BUY NOW



Nolvasan S Cleaner

For disinfection of inanimate objects to aid in control of numerous canine, bovine, and equine infectious viruses. Concentrated, mix with clean water.

RXNOLS-16 1 pint \$23.50/btl

BUY NOW



Foaming Autoclave Cleaner

Foaming Autoclave Cleaner. The steam autoclave is a workhorse in today's veterinary clinic. Its heavy use even with distilled water results in dark brown scale deposits on the inside chamber. If not regularly cleaned, these deposits will foul the surgical pack and affect the performance and longevity of the autoclave. It is recommended to clean the autoclave after every 20 cycles, or once per month if used everyday. The JorClave foaming autoclave cleaner will remove all rust spots, stains, and corrosion. In addition scale, alkaline and mineral deposits on the inside chamber walls of autoclave. It also works well on stainless steel carts, trays, or surfaces.

- Mild acidic solution removes rust, stain, spotting, and corrosion
- Most other solutions are slightly alkaline, but the actual deposits are alkaline in pH.
- Foaming action stays on surface longer than standard liquid spray
- Pump spray goes on easily and quickly
- Restores original finish
- No more noxious odor from walls of autoclave

JOR646 \$12.75/ea

BUY NOW



Pink Germicide

BUY NOW

An inexpensive disinfectant that allows the submerged instrument to be quickly used after just 10 minutes. It has an anti-corrosive agent that makes it safe to use with stainless steel instruments.

Germicide's advantages:

- Quaternary ammonium compound
- Fast acting
- Low Toxicity
- Ready-to-use, no dilution needed

JOR883 1 Gallon \$16.80/gl



Surgical Enzyme Cleaner

BUY NOW

This cleaner is excellent for removing stubborn organic debris that can stain your surgical instruments. It is a blend of four different enzymes to be the most effective cleaner available.

Free of metal attacking agents. Does not contain scale forming phosphates, chlorides or hydroxides

- Concentrated for best economy. Only 1 oz. (30ml) is needed for 1 gallon of wash solution
- Cleans a wide range of metal surfaces. Safe and effective for stainless steel, aluminum, tungsten carbide, copper and brass instruments
- Available 4 gallons/case

JOR649 1 gallon \$48.00/ea





Instrument Cleaners

Enzymatic Instrument Cleaner (A) **BUY NOW**

Enzymatic Detergent is a specially formulated presoak and cleaner designed to provide one-step cleaning of delicate fiber optic equipment such as endoscopes and cytoscopes, as well as other surgical instruments including those for eye, cardiovascular and general surgery. It is designed as a soak solution for surgical instruments to be used immediately following their use in a surgical procedure. Hemolytic Neutral pH Bacteriostatic Double Enzyme, Non-corrosive, Free rinsing. Safe for scopes Can be used in ultrasonic cleaners. Cleans hard to reach surfaces One gallon bottle

B9 1 Gallon \$34.89/gl

Ultrasonic Cleaning Solution (B) **BUY NOW**

Concentrated cleaning solutions are non-ammoniated. This concentrated solution is designed to dilute one part concentrate to ten parts water. It is specially formulated to provide a mild yet effective solution for cleaning instruments. Properly used, it will easily remove blood and other body fluids for longer instrument life. One gallon.

JOR3826 1 Gallon \$60.00/gl

Manual and Ultrasonic Instrument Detergent (C) **BUY NOW**

This Manual and Ultrasonic Instrument Detergent is specially formulated for both manual and ultrasonic cleaners. It is safe for metals, plastics, glassware and rubber. This LOW FOAM cleaner is designed for use in mechanical washers, disperses quickly, and is well suited for automatic injection systems. When hand processing instruments heavily laden with gross organic debris, the use of this cleaner is recommended prior to disinfecting. It contains no animal enzymes and maintains a pleasant odor. It contains four enzymes and three enhancers that make it exceptionally effective in breaking down protein, blood and fat from lumens, box locks and channels. One Gallon bottle

LSD 1 Gallon \$21.00/gl

Enzymatic Instrument Pre-Cleaner Gel (D) **BUY NOW**

This product is designed for removal of proteinaceous matter from instruments and medical apparatus by coating these surfaces and sustaining moisture during transporting. Cleaner is biodegradable, non-corrosive, and will not stain instruments or equipment made of glass, metal, plastic or rubber.

EN220Z 22 oz \$11.95/btl

Instrument Lubricant (E) **BUY NOW**

Instrument Lubricant (sometimes called milk or milk bath products) is a ready-to-use product that extends instrument life. It helps keep scissors sharp with regular use, and ensures proper operation of hinges, box locks and joints to inhibit growth of bacteria, yeast and fungi. Just use after cleaning or before sterilization or decontamination.

IL220Z 22oz, ready to use \$10.95/btl

Instrument Lubricant Concentrate (F) **BUY NOW**

Surgical Instrument Lubricant Milk is used after every use of the instrument. Not only does this product lubricate all moving parts, but it helps prevent spotting, staining and rusting of your most precious instruments. This product is not a detergent or sterilizer. Instruments must be autoclaved after Surgical Instrument Lubricant Milk has been applied. The lubricant bath should be replaced at least weekly or more frequently depending on number of instruments processed. Ingredients: Water Polybutene Oleth-2 Oleic Acid Triethanolamine Methylparaben Propylparaben Hydrogenated Castol Oil One gallon makes SEVEN GALLONS of lubricant

ILG 1 gallon, concentrated \$21.00/gl

Surgical Neutral Detergent (G) **BUY NOW**

Ultrasonic and manual cleaning detergent for surgical instruments.

- Very concentrated. 5ml makes 1 gallon
- Works on metals, rubber, plastic and glass

- High suds with rust inhibitor
- Dispenser pump included
- Available 4 gallons/case

JOR647 Gallon \$48.00/ea

G



Sterilization, Disinfectants & Cleaners



Sterilization Trays

Jorvet Sterilization Cassette Tray

Useful for sterilizing and for storage between procedures.

JOR973H \$30.50/ea **BUY NOW**



Compact Dental Instrument Sterilization Cassette

This compact tray holds up to eight dental hand instruments. Fits into ultrasonic cleaners, plus is autoclavable up to 270°F. End covers snap off/on, for easy removal (left off when using a mouth mirror). A locking strap secures instruments.

JOR943C 4" x 7" x 5/8" \$31.90/ea **BUY NOW**

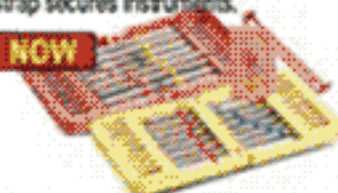

Jorvet Steri Container

A small sterilizable kit that holds a few special instruments. This hinged-lid container fits into ultrasonic cleaners, plus is autoclavable.

JOR943X 8" x 1 3/4" x 1 3/4" \$15.30/ea



Knife Storage Tray (Sterilization Tray)

This autoclavable tray holds small knives like test or tendon knives via two silicon bars.

JOR667 6" x 2 1/2" x 3/4" \$30.00/ea



Cold Sterilization Storage Tray

BUY NOW

Three piece soaking and sterilization set is ideal for cold soaking instruments. The perforated tray can be lifted out of any solution.

- Stainless steel latches seal the tray
- Can be autoclaved up to 300° F
- Red fiberglass reinforced plastic

JOR369 6" W x 9 3/4" L x 4 1/2" H. \$92.00/ea
 JOR369L 11" W x 17" L x 6" H. \$162.00/ea

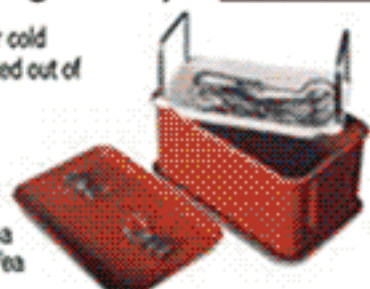

Sterilization Tray

BUY NOW

This two layer tray can hold any type of instrument. The rubber mat allows instruments to lay in any configuration. It is autoclavable and can be cold sterilized.

JOR41T Two later tray, 10" x 6" x 1.5" \$158.00/ea



Sterilization Tray w/Mat

Autoclave Tray with rubber mat.

JOR664T 6" X 4" With Mat \$39.00/ea



Jorvet Sterilizing Tray

BUY NOW

Holds a spay surgery pack.

JOR665L X-Large, Two layers, 15" x 10" x 2 1/2" \$468.00/ea
 JOR665 Large, 15" x 10" x 1" \$280.00/ea

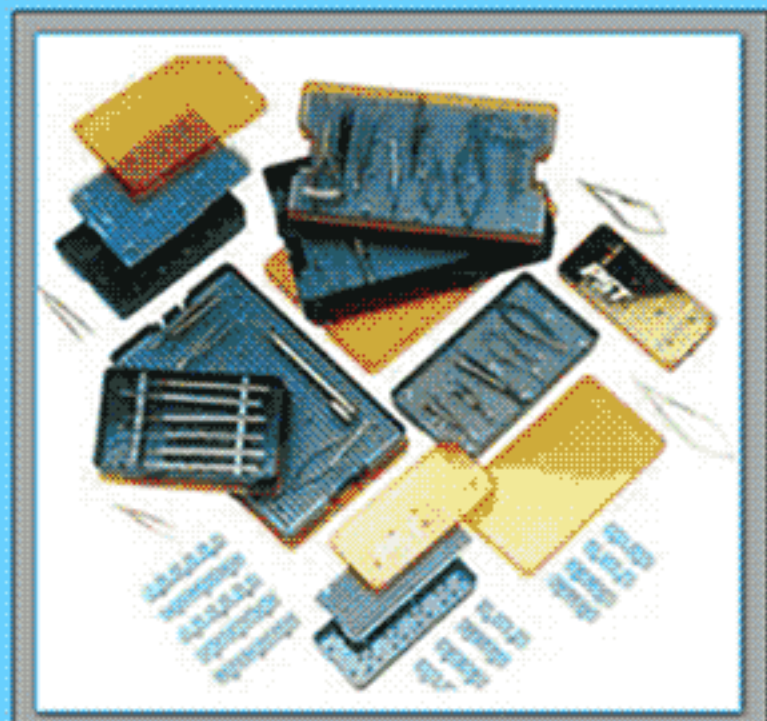

Rigid Endoscope Storage Tray

Two silicone bars hold scope in safe carrying/storage case.

JOR666 16" x 2 1/2" x 1 1/2" \$132.00/ea



Jorvet Small Soaking Tray

Cold Sterilization Soaking Trays. Durable plastic made to withstand disinfectants and sterilants. All have drain baskets that allow lifting the tray out of solution and having the solution drain back into the main container. Equipped with fitted sealed lid.

JOR882B 10" x 5" x 3" Grey \$89.00/ea
 JOR882C One-pint volume, 3-1/2" W x 8" L x 2-1/4" H. \$58.50/ea

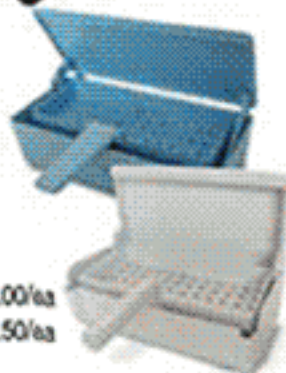

Clear Cold Sterilization Tray

Durable plastic made to withstand disinfectants and sterilants. All have drain baskets that allow lifting the tray out of solution and having the solution drain back into the main container. Equipped with fitted sealed lid.

JOR882 20" x 12" x 6" Large \$196.00/ea



Sterilization, Disinfectants & Cleaners



Disinfectants, Cleaners & Wipes

Germicidal Disinfectant Detergent

A quaternary-based all-purpose bactericidal, virucidal and fungicidal disinfectant detergent with unique neutral pH formula which will not leave a film. Use in veterinary hospitals, kennel rooms, cages and on food and water bowls. Effective against most pathogenic organisms found in veterinary clinics and kennels including Salmonella, Staphylococcus, Pseudomonas, Escherichia coli, Trichophyton, Canine distemper, feline parvovirus, Herpes Simplex Type 1 & 2, HIV-1, HIV-2, Infectious bovine rhinotracheitis, Influenza A2, Pseudorabies and Vaccinia according to the criteria established by the U.S. Environmental Protection Agency for registration and labeling of a disinfectant product as a bactericide, fungicide, or virucide.



RNAL 1 Gallon \$36.00/gl **BUY NOW**

Cavicide Disinfectant **BUY NOW**

Cavicide is an effective, ready to use, multi-purpose, broad spectrum solution for use on the surfaces of inanimate objects. Especially useful in O.R.'s, E.R.'s, isolation areas, labs and other critical areas where environmental infection control is necessary.

CV1000 1 Gallon \$31.08/gl
CV1024 24 fl Oz \$11.90/btl



Cavicide Wipes **BUY NOW**

The power of Cavicide in a wipe! Pre saturated with Cavicide, the cloth wipes are proven to kill both TB and Hepatitis B. Durable, non-woven, non-abrasive towels that don't bunch up during use. Does the job of three products - cleaner, disinfectant and decontaminant. 160 per tub.

CV1100 160 wipes \$11.50/btl



Disinfecting Wipes **BUY NOW**

For use on Environmental surfaces. Disinfect and Deodorize conveniently with easy pop-up dispenser. For use on hands and nonporous surfaces. 50 Pre-saturated Wipes. Double extra large wipes are three times the size of regular wipes.

DISWIPE 50 wipes \$10.50/ea



Parvosan Disinfectant

RIPARVOSAN gallon \$33.00/gl

BUY NOW



Hose End Sprayer **BUY NOW**

Heavy-duty hose-end sprayer is built tough for professional use. Automatically meters cleaner/ disinfectant concentrate to the exact ratio. Combines attachments for both heavy-duty blasting and foaming. Features a quick-disconnect coupling reservoir.

ACE-950GMR adjusts to ratios of 0.5, 1, 2, 4.5 and 6 oz/gal \$110.00/ea



Glutaraldehyde Cold Sterilization Solution

BUY NOW

Glutaraldehyde is used as a cold sterilant to disinfect and clean heat-sensitive equipment such as dialysis instruments, surgical instruments, suction bottles, bronchoscopes, endoscopes, and ear, nose, and throat instruments. This chemical can also be used as a tissue fixative in histology and pathology labs and as a hardening agent in the development of x-rays.

MX1400	14 day 1 Gallon	\$21.92/gl
MX1405	14 day 1 quart	\$10.36/qt
MX2800	28 day 1 Gallon	\$25.86/gl
MX2805	28 day 1 quart	\$10.95/qt



Disinfectant Cleaner **NEW**

Surface Disinfectant that kills a wide range of pathogens in ONE MINUTE. Meets OSHA's Bloodborne Pathogen Standard.

DISG 1 Gallon \$23.95/gl
DISQT 1 Quart \$9.95/qt

BUY NOW



Wavicide Sterilizing Solution

The preferred solution for items like endoscopes, that cannot be autoclaved. A 30-day, 2.65 percent glutaraldehyde sterilizing solution. It is a true sterilant versus just a disinfectant. Wavicide is similar to other glutaraldehydes (i.e., Johnson and Johnson's Cidex). Wavicide is similar to other solutions as in:

- 2 percent glutaraldehyde solution
- Must pre-clean instruments before immersion
- Must rinse with sterile water before use
- Wavicide's advantages:
- No separate activator chemical needed
- Ready-to-use, no mixing or shaking
- Unused bottled solution keeps for full year
- 30-day reuse
- Use at room temperature
- Lemon scented

JOR881 quart \$15.30/ea
JOR881G gallon \$37.50/gl

BUY NOW



Floor Squeegees **BUY NOW**

Speed drying of your kennels and floors! "All-surface" neoprene squeegees. Nonmarking heads with a rim splash guard.

ACE-FS-K30	30" neoprene with 55" aluminum handle	\$70.00/ea
ACE-FS-K	22" neoprene with 55" aluminum handle	\$62.00/ea



Sterilization, Disinfectants & Cleaners

Deodorizers, Antiseptic & Rubbermaid Clean Up



Aerosol Deodorizer

These deodorizers represent the state of the art in odor control. This breakthrough formulation contains all the performance of a dry type freshener but with excellent bloom, greater suspension time, ultra-fine particles and no fallout residue. It is also safe for the ozone. These sprays use only the finest ingredients to insure a fantastic fragrance and superior odor neutralizers that work in seconds on odors from: SMOKE, DECAF, URINE, FECEES, SOLVENT, VOMIT, COOKING, ANIMALS AND MORE!!! Each can contains up to 3400 controlled sprays.

208-12	Citrus 7 oz	\$6.00/ea	12+\$5.00/ea
211-12	Spice 7 oz	\$4.50/ea	12+\$3.95/ea
217-12	Vanilla 7 oz	\$4.50/ea	12+\$3.95/ea



Aerosol Dispenser

The Stratus 2 Aerosol Dispenser includes:
5, 10, 15 and 20 minute multiple spray intervals.

- Day, night and 24 hour operation.
- Unique one battery design lasts for one year under normal conditions.
- Low battery/refill indicators.
- Services 6000 cubic feet.
- Operates with one "D" alkaline battery (not included).

999 Air Dispenser \$39.99/ea



Rubbermaid The WaveBrake® Mop Bucket, with Ringer, 26qt

The WaveBrake® mop bucket and wringer system reduces splashing, which means a safer environment, cleaner floors, and improved productivity.

- High efficiency side press wringer.
- Lasts 58 times longer than comparative wringers.
- Tested to exceed 50,000 wringing cycles, average wringers perform approximately 860 cycles.
- Premium tubular steel and Structural Web molded plastic.

7480 18 5/8" l x 15 5/8" w x 16 3/4" h, Mop Bucket w/ Ringer, 26 qt., ea \$66.79/ea



Rubbermaid® Mop Heads

For disinfection of inanimate objects to aid in control of numerous canine, bovine, and equine Infectious viruses. Concentrated, mix with clean water.

V118-71 Mop Head, 3/pkg \$13.15/pkg

Rubbermaid® Mop Handle

U716-71 Rubbermaid Mop Handle w/Head \$13.69/ea



Antiseptic Hand Gel

70% ethyl alcohol. Helps prevent cross-contamination when soap and water are not available. Fast-acting, waterless. No sticky or tacky residue.

AGEL 16oz \$9.95/bd

Epi-Clenz® Foam Hand Sanitize

MSC097040Z Foaming Instant Hand Sanitizer. \$5.99/ea

Antiseptic Towelette

Towelettes provide both an antiseptic and bactericidal with cleansing action. Benzalkonium chloride is ideal for general antiseptic cleaning. Cleansing towelettes are perfect for quick, antiseptic cleansing for patients and staff. Castile soap towelettes are either used for general cleansing or cleansing the perineal area before collection of any clean-catch urine specimens.

AT100 100/bx \$2.99/bx

Castile Soap Towelette

Gentle cleansing agent, ph balanced.

1304 100/bx \$2.99/bx

BUY NOW

Cleansing Towlette

Cleansing towelette for general wash-up... cleans and refreshes hands, face and body without soap and water. Contains alcohol 5%, benzalkonium chloride 1:200.

1301 5" X 7", 100/Box \$2.29/bx

Nice n' Fresh Moist Towelettes

Antiseptic towelette for general wash-up in convenient pop-up canister. 20% Alcohol content. 70 per canister.

1305 5.5" x 8", Pop Up Canister, 70/ct \$2.29/ct

BUY NOW



Sterilization, Disinfectants & Cleaners

All American Portable Sterilizer



A complete self-contained sterilizer with an immersion heating element, automatic thermostatic control, automatic release valve and pilot light. First in the field to develop an immersion type Pressure Sterilizer for all physicians' offices, hospitals and laboratories. Connects to any outlet and ready for use instantly. This compact and portable unit will quickly pay for its low cost in the saving of time alone. There are no additional supplies to purchase nor is there any maintenance cost other than the electric power consumed. The sterilizer is made of a high quality cast aluminum alloy with the special features of the famous ALL-AMERICAN Pressure Cookers. The portable electric automatic sterilizer meets all requirements for physicians, dentists, first aid stations, hospitals and laboratories. It will provide a complete and efficient sterilization facility with an extremely low cost. The ALL-AMERICAN Sterilizer is automatic in operation, controlled by a Fenwal thermostat and pilot light. Only a small amount of water is needed to create the dry steam. At a temperature of 250 degrees F. or 15 P.S.I., it penetrates the bandages or instruments, making them sterile in 30 minutes. (note: Sterilization time count begins when temperature and pressure levels are reached.)

- Available in 120v or 240v
- Operational on 50hz or 60hz
- Calrod immersion heating element
- 120 Volt AC, 1050 watt, 8 3/4 amps or 240 Volt AC, 1050 watt, 4.38 amps
- Fenwal thermostatic control
- Heavy cast aluminum cover & bottom construction
- Aluminum alloy seamless inset container
- Large sterilizing capacity (831 cubic inches)
- Aluminum rack
- Complete and effective sterilization at lowest possible cost
- Flexible metal exhaust tube
- Dial gauge and control valve
- 3-wire grounded cord and plug for safety
- Metal-to-metal seal (no rubber gaskets)
- Shipping weight: 30 lbs
- Packed in individual corrugated cartons

BUY NOW

**TOP
SELLER**



25X-120V	120 Volt	\$866.00/ea
25X-240V	240 Volt	\$886.00/ea
Accessories		
25X-2156	Aluminum Inner Basket	\$61.60/ea
GAUGE-S	Steam Gauge	\$16.55/ea

Ultrasonic Cleaner

BUY NOW

For the highest quality specialized instruments we now introduce a premium line of ultrasonic cleaners and cleaning solutions that keep your instruments spotless for longer lasting performance. What is ultrasonic cleaning and how does it work? High frequency sound waves are used to produce more than 40,000 alternating high and low pressures per second. As these waves travel through a specially formulated cleaning solution, millions of microscopic bubbles form and violently implode. This process, known as cavitation, creates a scrubbing action capable of cleaning up to 16 times more efficiently than hand scrubbing. In minutes, all body fluids and foreign particles are removed, even from the tightest grooves, cracks and interior surfaces of the instrument being cleaned. These ultrasonic cleaning systems represent the most advanced technology in ultrasonic cleaning available today.

Features:

- Heavy-duty transducer. 25 percent heavier. Providing greater power and better dissolution in the tank.
- Operation at higher Hz. Cleaner operates at 60,000 Hz. This higher Hz equals a short wave-length that increases efficiency in cleaning small crevices. Standard units operate at 35,000-40,000 Hz.
- Extended limited warranty of 2 1/2 years.



JOR382A	Standard 3-3/8 Quarts unit	\$748.00/ea
JOR382AB	Standard 3-3/8qt Basket	\$161.00/ea
JOR382B	1- 1/2 gallon Unit	\$1,010.00/ea
JOR382BB	Deluxe 1-1/2 gallon Basket (Optional)	\$172.00/ea

13822 WEST BOULTON BLVD. METTAWA, IL 60045

WWW.SHOPMEDVET.COM

Phone 800-544-7521

2715

Fax 800-204-2177

Odor Control

KOE Kennel Odor Eliminator Concentrate

Eliminates, not masks, odors. It even works on old, impregnated odors from cages, runs, walls and other large areas. Creates a mild, outdoor fresh odor. Concentrate (0.25 oz per gallon of water)

KOE	8oz	\$10.95/btl
KOE-G	gallon	\$79.00/gl

BUY NOW



AOE Deodorizing Wipes

Eliminates, not masks, odors from anal gland secretion, tom cat spray, necrotic tissue, urine, feces, emesis, etc. Used on animals, accidents, bedding, cages, litter or any place with companion malodor. Spray directly on the source of the odor. Can also be used as an air freshener. Ideal for deodorizing cat litter boxes and neutralizing tomcat spray in the home.

AOE-W	80 wipes/pack	\$7.95/pk
AOE-S	8oz	\$4.50/btl

BUY NOW



Cat-Odor Off

BUY NOW

Eliminates animal odors in carpets, upholstery and other porous surfaces from urine, tomcat spray, feces, emesis and more. Works where other products haven't and won't. Contains no enzymes so may be used without loss of efficacy with or after detergents (carpet shampoo) and germicides. Soaker, penetrates to the source of the odor. Sprays and powders only treat surface problems. Removes many stains.

CO-0	16oz	\$5.00/btl
CO-OC	16oz concentrate	\$11.99/btl

TOP SELLER



Dog-Odor Off

BUY NOW

Eliminates undignified dog odors including normal body odors, urine, feces, emesis and necrotic tissue. Used on dogs, accidents, cages, bedding or anywhere there is an animal related odor problem. Not an enzyme, bacteria or mask thus may be used after shampoos, cleaners, germicides without loss of efficacy. Eliminates odors without bathing. Fleas and ticks hate its natural cedar fragrance. Works better than cedar bedding because it stays with the dog wherever it goes.

DO-0	8oz spray	\$4.50/btl
DO-OC	16oz	\$4.85/btl



OdorzOut

BUY NOW

OdorzOut products consist of a blend of Zeolites. They have a honeycomb-like structure with pores which absorb and trap unpleasant and noxious odors. Zeolites have a negative molecular charge which attracts the dust particles, which in turn will eliminate the unwelcome odors. Zeolites unusual longevity is a result of millions of tiny micro-pores that give the material a great absorbent surface.

OPP-799	Powder, 755g	\$18.95/ea
---------	--------------	------------



Skunk-Off

BUY NOW

Stops skunk odor instantly and permanently on contact. Removes all traces of skunk spray from dogs, other pets, people, clothes, cars, homes, anybody or anything a skunk has sprayed or anything a skunk-sprayed animal has rubbed against. Safe, will not damage or irritate sensitive tissue of eyes, ears or nose. Liquid is applied full strength as a spray or soaker from the easy-to-use squeeze bottle. Shampoo is thoroughly applied to the entire animal and then rinsed.

S08	8oz liquid soaker	\$4.59/btl
S00	32oz liquid spray	\$19.99/btl
S05	8oz shampoo	\$5.05/btl



Citrus II Deodorizer

BUY NOW

Citrus spray leaves a fresh, clean, citrus scent that is neither too overpowering or too weak. Excellent to have on hand to freshen up the room during the summer! Room Deodorant Non-Aerosol.

CIT40Z	4oz bottle	\$5.99/btl
CIT70Z	7oz bottle	\$7.99/btl



Dynarex Washcloths premoistened with aloe

BUY NOW

- A fresh approach to incontinence and personal care needs.
- Soft, yet durable spunlace material for a soothing gentle touch
- Alcohol Free
- Contains lanolin and aloe vera skin conditioners
- Also available: low profile tubs which easily fit in most standard bedside end tables.
- Durable poly bagged refill packs which easily fit in our low profile tubs.
- Economical and environmentally friendly

1314	9 x 13, 46 tub	\$3.95/ea
------	----------------	-----------

Stethoscopes

Littmann Classic II S.E Stethoscope

Featuring a two-sided chest piece, the Littmann Classic II S.E. Stethoscope offers high acoustic sensitivity for superior performance. A tunable diaphragm on one side augments the traditional bell function of the opposite side. Traditional bell combined with a tunable diaphragm that conveniently alternates between low- and high-frequency sounds without the need to turn over the chest piece

- Excellent acoustic seal and comfortable fit with patented 3M Littmann® Snap Tight Soft-Sealing Eartips
- Comfortably angled, anatomically correct headset
- Patient-friendly, non chill rim and diaphragm
- Single-lumen tubing in multiple colors
- Three-year warranty

BUY NOW

2201	Black, 28" L	\$94.45/ea
2203	Gray, 28" L	\$94.45/ea
2205	Navy, 28" L	\$94.45/ea
2206	Caribbean Blue, 28" L	\$94.45/ea
2208	Hunter Green, 28" L	\$94.45/ea
2209	Purple, 28" L	\$94.45/ea
2211	Burgundy, 28" L	\$94.45/ea
2210	Raspberry, 28" L	\$94.45/ea



Littmann Select Stethoscope

This unique patented chest piece is specifically designed for healthcare professionals general examination needs including heart, lung, blood pressure and other body sounds. Only 3M® Littmann™ delivers this degree of excellence in a stethoscope.

2290	Black, 28" L	\$57.65/ea
2291	Caribbean Blue, 28" L	\$57.65/ea
2293	Burgundy, 28" L	\$57.65/ea
2294	Purple, 28" L	\$57.65/ea
2298	Royal Blue, 28" L	\$57.65/ea

BUY NOW



JorVet Dual Head Stethoscope

Affordable stethoscope with great performance

- Dual head swivels for cardiac exams and breathing
- Auscultation
- Wide range of fun colors.
- 30" Long tubing length.

NEW

JOR205G	Gray, 30" L	\$24.45/ea
JOR205R	Red, 30" L	\$24.45/ea

BUY NOW



Dual Head Stethoscope

This quality stethoscope features chrome binaural silver chest piece, 22" Y tubing and a pair of mushroom ear tips. Overall length is 30". No color choice.

STDH Dual Head, 28" L \$8.99/ea

BUY NOW



TOP SELLER

Single Head Stethoscope

Offers an economical solution for those situations that require a quality listening device. Features a chrome binaural silver chest piece, 22" Y-tubing and a pair of mushroom eartips. Overall length is 30". Single head. No color choice.

STN Single Head, 30" L \$5.99/ea

BUY NOW

TOP SELLER



Sprague-Rappaport Stethoscope

The most popular stethoscope on the market today. Heavy walled 22" tubing blocks out extraneous sounds even in the noisiest conditions. The overall length is 32". No color choice.

STSR Sprague-Rappaport, 22" L \$15.90/ea

BUY NOW

TOP SELLER



Littmann Master Cardiology Stethoscope

A tunable diaphragm and superb craftsmanship offers the ultimate performance in a superior stethoscope. The Littmann Master Cardiology stethoscope meets the exacting standards of healthcare professionals who demand very high acoustic response.

- Tunable diaphragm conveniently alternates between low and high-frequency sounds without the need to turn over the chest piece
- Handcrafted solid stainless steel chest piece
- Two-in-one tube design eliminates tube rubbing noise
- Portable convenience of a single-sided chest piece
- Excellent acoustic seal and comfortable fit with patented 3M Littmann® Snap Tight Soft-Sealing Eartips
- Comfortably angled, anatomically correct headset
- Patient-friendly, non chill rim and diaphragm.
- Special procedures adaptor for difficult site or pediatric auscultation
- Available in multiple tube colors
- Seven-year warranty

BUY NOW

2160	Black, 27" L	\$249.15/ea
2163	Burgundy, 27" L	\$249.15/ea
2164	Navy, 27" L	\$249.15/ea
2165	Hunter Green, 27" L	\$249.15/ea



Stethoscopes



Littmann Master Classic II Stethoscope

The excellent acoustic sensitivity of a tunable diaphragm is the hallmark of the low-profile Littmann Master Classic II stethoscope. Award-winning design combines high performance and portable convenience in this stethoscope with a single-sided chest piece.

- Tunable diaphragm conveniently alternates between low- and high-frequency sounds without the need to turn over the chest piece.
- Excellent acoustic seal and comfortable fit with patented 3M™ Littmann® Snap Tight Soft-Sealing Eartips.
- Portable convenience of a single-sided chest piece.
- Comfortably angled, anatomically correct headset.
- Patient-friendly, non-chill rim and diaphragm.
- High-performance, single-lumen tubing in multiple colors.
- Three-year warranty.



2143	Purple, 28" L	\$130.65/ea
2144L	Black, 28" L	\$130.65/ea
2146	Burgundy, 28" L	\$130.65/ea
2147	Navy, 28" L	\$130.65/ea
2630	Caribbean Blue, 28" L	\$130.65/ea
2632	Hunter Green, 28" L	\$130.65/ea

BUY NOW

Littmann Cardiology III Stethoscope

Outstanding acoustic performance and exceptional versatility characterize the Littmann Cardiology III stethoscope. The innovative design offers a tunable diaphragm on each side of the chest piece. The large side can be used for adult patients, while the small side is especially useful for pediatric or thin patients, around bandages, and carotid assessment.

- Two tunable diaphragms conveniently alternate between low- and high-frequency sounds without turning over the chest piece.
- Solid stainless steel chest piece.
- Two-in-one tube design eliminates tube rubbing noise.
- Excellent acoustic seal and comfortable fit with patented 3M™ Littmann® Snap Tight Soft-Sealing Eartips.
- Comfortably angled, anatomically correct headset.
- Patient-friendly, non-chill rim and diaphragm.
- Available in multiple tube colors.
- Five-year warranty.



3128	Black, 27" L	\$206.20/ea
3129	Burgundy, 27" L	\$206.20/ea
3130	Navy, 27" L	\$206.20/ea

BUY NOW

Littmann Classic II S.E Combination Kits

BUY NOW



Littman™ Match Mates kit
INCLUDES:

- Littman Classic II S.E. scope.
- Easy to read gauge with luminescent dial.
- Color coordinated adult-size nylon cuff and zippered carrying case.

Littman Classic S.E. II Stethoscope
FEATURES:

- Traditional bell combined with the patented tunable diaphragm.
- Single-lumen tubing.
- Non-chill rim.
- Soft-sealing eartips.
- Three-year stethoscope warranty.

12-260-021	Black	\$139.55/ea
12-260-071	Burgundy	\$139.55/ea
12-260-201	Purple	\$139.55/ea
12-260-241	Navy	\$139.55/ea
12-260-251	Hunter Green	\$139.55/ea



FREE GIFTS with your purchases

Your Choice
(1) \$25 American Express (with \$500 Level Purchase) OR
(1) Digital Camera (with \$500 Level Purchase)

BUY MORE GET MORE!

Example: Spend \$1,000 and get a free \$25 gift card and a free digital camera
(See inside front cover for details)

Stethoscopes & Laryngoscope Blades



Ultrascope Stethoscope

BUY NOW



Enormously popular in the human medical field. The stethoscope head is pressure sensitive for assessment of heart and lung sounds. The scope will filter noises, such as barking dogs, while amplifying heart and lung sounds. Combines great acoustics with your choice of 15 custom colors (call for choice of color) & 25 custom designed heads. Features cardiology style tubing. Total weight 4 oz. The head design features an acoustic resonant amplifier with frequency range 20- 35 kHz and solid acrylic one-piece design weighing 2 oz. Ultrascope are custom made to order, therefore they are non-returnable. **NOTE:** If diaphragm wears out due to normal wear, it will be replaced for free.



Custom Heads. Additional designer heads, background colors, and engraving available upon request.

JOR20SU	Head, Regular, 2" diaphragm.	\$103.00/ea
JOR20SUC	Ultrascope Classic Stethoscope. 1- Binaural Tubing, 1 head/2 stems for "experienced, mature users".	\$118.00/ea
JOR20SUD	Duo Stethoscope. Two same or different size heads, one tubing.	\$170.00/ea
JOR20SULA	Large Animal Stethoscope. Includes two extension tubes, maximum 50"L.	\$134.00/ea
JOR20SUN	Head, Neonatal. 1/2" diaphragm. Clear or color swirl.	\$103.00/ea
JOR20SUP	Head, Pediatric. 1 1/4" diaphragm.	\$103.00/ea
JOR20SUT	Trio Stethoscope. Three same or different size heads, one tubing.	\$221.00/ea
JOR20SUTE	Teaching Stethoscope. Includes two binaural tubings for both instructor and student.	\$108.00/ea

Ultrascope Stethoscope Parts

JOR20SUE	Custom engraving for Ultrascope.	\$14.00/ea
JOR20SUE	Ear-tips only for JOR20SU	\$4.50/ea

JOR20SUTE



BUY NOW



JOR20SU

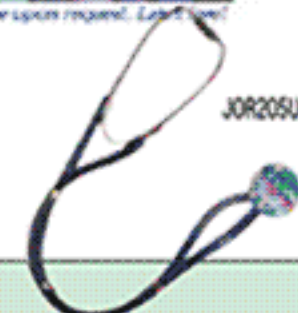

JOR20SUC

Miller Laryngoscope Blade

BUY NOW

Straight shaft with gentle curved tip.

JOR449A	Size #0, 53mm	\$54.00/ea
JOR449B	Size #1, 80mm	\$54.00/ea
JOR449C	Size #2, 130mm	\$54.00/ea
JOR449D	Size #3, 173mm	\$54.00/ea
JOR449E	Size #4, 180mm	\$54.00/ea



Designed to work for swine intubations. *Not Pictured*

JOR449F	12' Length	\$84.00/ea
---------	------------	------------

Laryngoscope Replacement Light Bulb.

JOR449R	Short Bulb. Used for JOR449a through JOR449am blades. Sizes 10mm and 3mm.	\$7.50/ea
JOR449RL	Long Bulb. Used for JOR449b through JOR449f and JOR449bm through JOR449em blades. Sizes 12 mm and 6mm.	\$9.00/ea

BUY NOW



McIntosh Laryngoscope Blade

BUY NOW

Curved along entire length of blade.

JOR449AM	Size #0, 60mm	\$39.00/ea
JOR449BM	Size #1, 66mm	\$39.00/ea
JOR449CM	Size #2, 85mm	\$39.00/ea
JOR449DM	Size #3, 110mm	\$39.00/ea
JOR449EM	Size #4, 140mm	\$39.00/ea



Laryngoscope Handle

BUY NOW

Special Penlight Handle only. Works great for cats.

JOR449P	Uses 2-AA batteries	\$30.00/ea
JOR449M	Uses 2 "C" batteries.	\$30.00/ea



Rechargeable Battery

72000	Weich Ailyn, 2.5v	\$40.00/ea
-------	-------------------	------------

Diagnostic Supplies

Otoscopy & Ophthalmoscopes

Diagnostic Set

- Medium battery handle.
Uses two "C" (2.5v) batteries (not included)
- Otoloscope head, 4x magnification
 - Three veterinary long specula
 - 80mm x 6mm
 - 80mm x 4mm
 - 58mm x 5mm
 - One spare bulb
 - One ophthalmoscope head
 - Case



BUY NOW

JOR45 Uses two "C" (2.5v) batteries \$169.00/ea

Otoloscope

Gowland's Otoloscope with veterinary length specula.
JOR45A 4x. Uses two "C" batteries \$146.00/ea



BUY NOW

Otoloscope Cone

Use cold sterilization only. For use with lightsource
JOR114S For use with lightsource JOR114bh \$5.40

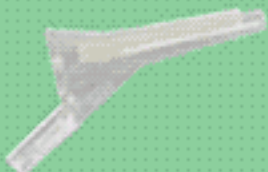

BUY NOW

Otoloscope Cone

23834 4mm, Welch Allyn, Macroview Otoloscope \$5.50/ea
23835 5mm, Welch Allyn, Macroview \$5.50/ea

BUY NOW

Otoloscope/Ophthalmoscope Combo Kit

This outstanding Ri-Mini Combination Kit features both an otoloscope and an ophthalmoscope and includes a connector for pneumatic testing, replacement ear specula, replaceable 2.5V halogen lamp and is packaged in a traditional hard storage case. Operates with two AA batteries (not included).

20-312 Combo Kit \$272.75/ea



BUY NOW

Ri-Mini Ophthalmoscope

The Reister Ri-Mini Ophthalmoscope is designed for the examination of the eye and its background. Correcting lenses with diopter ranges of 0 to +20 and 0 to -20 can be adjusted on the lens wheel and four different aperture and/or filters can be selected. Operates with two "AA" batteries (not included).

20-311 Mini-Ophthalmoscope \$180.00/ea



BUY NOW

Welch Allyn Diagnostic Kit

We offer two Welch Allyn Diagnostic Kits, each comes complete with a standard ophthalmoscope, choice of otoloscope, a direct plug-in rechargeable handle and a soft case. Set One

- includes:**
3.5v standard ophthalmoscope.
- 3.5v otoloscope (operating or pneu), complete with three polypropylene specula sizes 4, 5 and 7mm.
 - Direct plug-in rechargeable 3.5v handle, 100-130v, 50/60Hz.

96121 Kit w/Pneumatic otoloscope \$607.16/ea
96171 Kit w/Operating otoloscope \$711.17/ea



BUY NOW

Reister Diagnostic Kit

The Reister Diagnostic Kit offers a battery operated bayonet with multiple instrument heads. Operates with two "C" batteries (not included)
This kit includes:

- Chrome-plated bent arm illuminator.
- Two chrome-plated Laryngeal Mirrors (3.0mm & 4.0mm).
- May ophthalmoscope with lens wheel and correcting lens diopter ranging from -20 to +20.
- Chrome-plated nasal speculum that manually opens & closes.
- Chrome-plated otoloscope.
- Three reusable specula.
- Swivel magnifying lens and an outlet for pneumatic testing.
- Chrome-plated tongue blade holder that holds wooden & plastic blades.
- Traditional hard storage case.

20-205 Complete Kit \$216.35/ea



BUY NOW

Reister Otoloscope

The Reister Economy Otoloscope offers superior optics and craftsmanship. Unit comes complete with bayonet otoloscope head, three reusable specula, swivel magnifying lens, and comes in a vinyl storage pouch. Operates with two C batteries (not included).

20-660 Reister Kit \$81.80/ea



BUY NOW

Replacement Otoloscope Bulb

Replacement Bulb

23-390 Fits 20-660 Otoloscope \$7.50/ea
23-600 Fits #20-310 Otoloscope \$20.00/ea
23-605 Fits #20-311 Otoloscope \$25.00/ea

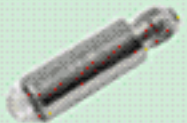

BUY NOW

Ri-Mini Otoloscope

When combined with an ear speculum, the Reister Ri-Mini Otoloscope is the ideal instrument to use for lighting and examining the auditory canal. Includes replaceable 2.5V halogen lamp and traditional hard storage case. Operates with two "AA" batteries (not included).

20-310 Mini-Otoloscope \$125.45/ea



BUY NOW

Otosopes & Ophthalmoscopes

Welch Allyn 3.5V Coaxial Ophthalmoscope Head

The Welch Allyn ophthalmoscope comes with a Halogen HPXTM lamp that provides 30% more light output, for true tissue color and consistent, long-lasting illumination, coaxial optical system for shadow-free spot and easier entry into undilated pupil, crossed linear polarizing filter to reduce corneal reflection, red-free filter for use with any aperture, 18 possible aperture combinations for greater versatility and sealed optics. Handle not included.



BUY NOW

11720	Coaxial Ophthalmoscope	\$258.94/ea
11730	AutoStep Coaxial	\$310.73/ea

Welch Allyn 3.5V Standard Ophthalmoscope Head

The Welch Allyn ophthalmoscope comes with a halogen light for true tissue color and consistent, long-lasting illumination. Six aperture selections for general and specialty uses, 28 lenses (-25 to +40 diopters) for better resolution, rubber brow rest and illuminated lens dial clearly identifying setting. Handle not included.

BUY NOW



11710	Head Only	\$238.40/ea
-------	-----------	-------------

Welch Allyn 3.5v Rechargeable Handle

BUY NOW

These Welch Allyn 3.5v rechargeable handles are universal, accepting all Welch Allyn 3.5 instrument heads. Chrome plated with smooth, non-abrasive knurled finishes to ensure a no-slip grip, well-balanced and fit comfortably in the hand with the weight distributed evenly end to end, come with a long-lasting nickel-cadmium battery, have a safety switch to prevent accidental draining of the battery and metal head connectors for durability.



NEW

71000-A	Handle, 3.5V	\$151.78/ea
---------	--------------	-------------

Welch Allyn Diagnostic 2.5V Oscope with Specula

BUY NOW

This Welch Allyn 2.5v Diagnostic Oscope uses a halogen light for true tissue color and consistent, long-lasting illumination. Its fiber-optics produce cool light with no reflection, no obstruction. The wide angle viewing lens allows instrumentation under magnification.



DISCONTINUED

24031	Head Only	\$151.79/ea
-------	-----------	-------------

Digital MacroView™ Veterinary Oscope

BUY NOW

The Welch Allyn Digital MacroView™ Veterinary Oscope is a simple, affordable tool that lets you see, explain, and save digital images of the ear.

Improves

- Communication which can lead to better client compliance
- Gives you an excellent training aid for educational purposes
- Offers you the ability to view small details of ears, mouth, and teeth
- Allows you to store digital images in patient records for enhanced documentation of exam findings
- Provides you the ability to share images with other providers as visual descriptive reference
- Compatible with all Welch Allyn 3.5V power sources



23960	\$2,200.00/ea
-------	---------------

NEW

Welch Allyn 3.5V Pneumatic Consulting Oscope Head

BUY NOW

The Welch Allyn Pneumatic Consulting Oscope comes with a Halogen HPXTM lamp that provides 30% more light output, for true tissue color and consistent, long-lasting illumination, two viewing lenses for dual observation, teaching and consulting, fiber-optic illumination for cool light, a sealed system for pneumatic otoscopy and a rotatable head for left and right side viewing. Handle not included. Comes with 3 polypropylene specula: sizes 4, 5 & 7mm.



20262	Head Only	\$496.19/ea
20260	Head Only	\$231.98/ea

Welch Allyn 3.5V Operating Oscope Head

BUY NOW

The Welch Allyn Pneumatic Oscope comes with a Halogen HPXTM lamp that provides 30% more light output, for true tissue color and consistent, long-lasting illumination, open system for convenience during procedures, rotatable lens and speculum for ease of use and fiber-optic illumination for cool light. Handle not included. Comes with 3 polypropylene specula: sizes 4, 5 & 7mm.



21760	Head Only	\$227.46/ea	DISCONTINUED
-------	-----------	-------------	---------------------





Pocket scopes & Bulbs

Welch Allyn Pocketscope Power Sources

- Adjustable rheostat controls light intensity. **BUY NOW**
- Compact pocket clip.
- Accepts all Welch Allyn 2.5v PocketScope instrument heads.
- Compact, lightweight, well-balanced, and comfortable in the hand.

72800	Handle with Rechargeable Battery	\$121.43/ea
72600	2.5V Battery only	\$37.01/ea
72801	Handle without Battery	\$86.61/ea
72830	Handle with AA Batteries	\$65.19/ea
79290	Desk Charger, 2.5V, 100-130V, 50-60HZ	\$327.96/ea



Welch Allyn Pocketscope 2.5V Otoscope

The Welch Allyn 2.5v PocketScope™ Ophthalmoscope features a halogen light for true tissue color and consistent, long-lasting illumination, built-in throat illuminator/pen-light, wide angle viewing lens for instrumentation under magnification, sealed system for pneumatic otoscopy and fiber-optic illumination for cool light with no reflections or obstructions and is compact. **BUY NOW**

22800	Rechargeable batteries	\$240.19/ea
22820	Uses 2 AA batteries	\$210.71/ea



Welch Allyn 3.5v Rechargeable Battery

Replacement NiCad Rechargeable Battery

72200	3.5V	\$45.79/ea
72300	3.5V FOR 71000A & 71000C	\$45.79/ea

WelchAllyn® **BUY NOW**

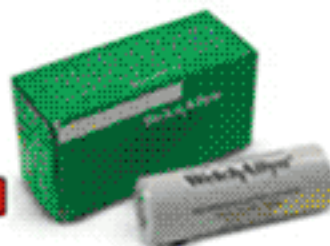

Vacuum Lamp

BUY NOW

Welch Allyn® 7v Vacuum Lamp Model 02000-U

02000-U For light# 45003 \$4.14/ea

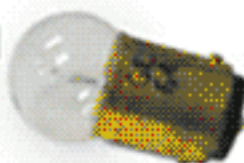

Welch Allyn Desk Charger

Featuring advanced circuitry for consistent automatic safe charging and optimum lamp performance and life. They are compact for easy mobility and convenience and come with optional wall brackets for permanent mounting on walls or cabinets. Charger fits both 3.5v and 2.5v handles. Available with internal specula tray (5" x 7" x 2 1/4").

71140	Charger	\$233.04/ea
71630	Holds 2 3.5V Handles Wa	\$490.20/ea

BUY NOW

WelchAllyn®



Welch Allyn 2.5v Pocketscope Ophthalmoscope

BUY NOW

The Welch Allyn 2.5v PocketScope™ Ophthalmoscope features a halogen light for true tissue color and consistent, long-lasting illumination, 5 aperture selections for general and specialist use, 48 lenses for better resolution, a polarized filter to reduce corneal reflection and is compact.

12800	with rechargeable battery	\$295.54/ea
12820	with AA battery	\$271.20/ea



WelchAllyn®

Indirect Viewing Lens

Jorvet

BUY NOW

Aspheric 20 diopter hand held lens. This 20 diopter all glass indirect convex lens combined with a source of direct illumination i.e. bright penlight allows for indirect ophthalmoscopy of the fundus. The veterinarian holds the lens in front of the animal's eye. At arm's length, the veterinarian direct light at lens:

- Provides a larger field of view of the fundus than is possible with a standard ophthalmoscope
- Exam at safe distance with fractious animals
- Comes with blue velour storage bag

JOR992	2 1/2"d x 1/2" thick	\$52.00/ea
--------	----------------------	------------





Illuminators, Speculums & Bulbs

Welch Allyn 3.5v Wall Transformer

The 767 Wall Transformer is designed to put everything needed for fast, accurate diagnoses at arm's length. And it does this in a convenient, modular package. Features handle-based rheostat for quick light-intensity adjustments, contoured handles that are easy to hold and maneuver, a high-impact ABS housing, modular coiled cords that are guaranteed for 10 years and new Halogen HPX lamps that provide 30% more light.

BUY NOW



76710	Wall Transformer	\$466.09/ea
76720	Wall Transformer with clock	\$525.01/ea
76730	Third Handle Module	\$260.23/ea
71420	Bracket	\$56.26/ea

WelchAllyn®

Welch Allyn IndirectViewing Lens

20 diopter all-glass indirect convex viewing lens allows for less distortion while providing for a larger field of view. Allows for examination at a safe distance from fractious animals. Combined with a source of direct illumination, allows a veterinarian to perform monocular indirect ophthalmoscopy. At arms length, the examiner directs light on the viewing lens, which then reveals an inverted picture of the fundus.

12300	20 Diopter	\$81.60/ea
-------	------------	------------



BUY NOW

WelchAllyn®

Polypropylene Specula

The material used in the Welch Allyn Reusable Polypropylene Specula is lightweight but durable. The specula may be autoclaved, boiled, or sterilized in solution and can be attached easily.

24303-U	3mm	\$2.50/ea
24304-U	4mm	\$2.50/ea

These fit Diagnostic Scopes only

BUY NOW



Welch Allyn Illuminator 3.5V

Featuring the new Halogen HPXTM lamp that provides 30% more light output, for true tissue color and consistent, long-lasting illumination, fiber-optic illumination for cool light and is convertible to a throat illuminator/penlight.

26530	Nasal Illuminator w/9mm speculum	\$98.20/ea
26535	Nasal Illuminator	\$44.64/ea



WelchAllyn® **BUY NOW**

Welch Allyn 3.5v Transilluminator

Featuring a HPXTM lamp, fiber-optic transmission for cool distal light and fully sterilizable. Optional cobalt blue filter.

41100	Finoff Ocular transilluminator	\$91.07/ea
41101	Finoff Ocular transilluminator w/Cobalt Blue Filter	\$136.90/ea
41102	Cobalt Blue Filter	\$32.13/ea
43300	Curved Transilluminator	\$109.83/ea



BUY NOW

WelchAllyn®

Welch Allyn Halogen Lamp

BUY NOW

Lamp bulbs provide a halogen light for true tissue color and consistent, long-lasting illumination.

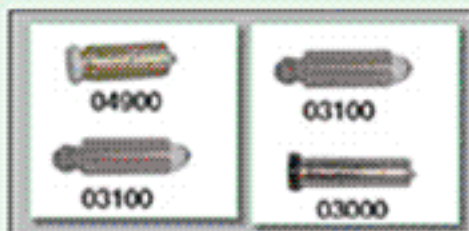

WelchAllyn®

03900	Fits Scope# 12810 & 11110	\$22.25/ea
04900	Fits Scope# 11720, 11730, 11620, 11630	\$30.02/ea
03000	Fits Scope# 11710, 11600, & 11610	\$22.88/ea
03100	Fits Heads # 25020, 21700, 20200, 20202	\$21.18/ea
06000-U	Fits Laryn. Handle# 60803 & 60804	\$22.65/ea

MED-VET'S SCRUBS DEPOT

(1) 99¢ CLOSEOUT Scrub with every \$10 purchase

CLOSEOUT SCRUBS 99¢/ea

While Supplies Last!





Basic Laboratory Microscope

Premiere Brand

- Real optical glass lenses
- 10x widefield eyepiece
- 3 Achromatic objective lenses 4x, 10x, 40x Power
- Magnification from 40x to 400x
- 90mm x 90mm Stage with clips
- 6 Hold disc diaphragm
- 5 prepared glass slides
- Overall size: 4" x 6" x 11"

BUY NOW



MFL-02 Complete Scope kit \$112.00/ea

Binocular Microscope Replacement Bulb

MA13 For MFL-02 \$10.00/ea

Ultimate Laboratory Microscope

The same great optics are now even more versatile on a new base with a rechargeable battery light source. The detachable AC power cord can be used to power the light or recharge the battery for portable use "in the field". Battery lasts for hours and can be recharged hundreds of times for years of valuable scientific research!

MFL-05 Complete Scope kit

\$130⁰⁰/ea

BUY NOW



Binocular Microscope

Technical Features:

- 30 degree inclined binocular Seidentopf style head, rotatable 360 degree
- Eye piece: 10x wide-field
- 4 DIN objectives: 4x (N.A. 0.10), 10x (N.A. 0.25), 40x (N.A. 0.65), 100x (oil immersion, N.A. 1.25)
- Magnification: 40x to 1600x
- 4 1/2" X 5" (120x125mm) Mechanical stage with coaxial drive/rack and pinion adjustment, left hand controls
- Abbe condenser NA 1.25 with iris diaphragm
- Filter (Blue and Green)
- Coaxial coarse and fine focusing and low knob position
- Built in variable intensity halogen illuminator, 6V 15W
- UL approved 3 wire cord
- Plano-concave mirror (reflector) for ease in outdoor use
- Spare bulb and fuse
- Eye piece pointer for learning aid (optional)
- Size: 6"x8"14 1/2"H, H.W. : 11 lb

MRJ-03 Complete Scope kit \$595.00/ea

BUY NOW



Accessories

Binocular Microscope Eye Piece Pointer

MA03 Eyepiece Pointer \$10.00/ea

Binocular Microscope Replacement Bulb

MA07 For MRJ-03 \$10.00/ea

16X Eyepiece for MRJ-03 Binocular Microscope

EYEPIECE 16X Eyepiece \$17.14/ea

Binocular Microscope Fuse

MA01 For MRJ-03 3/Pk \$10.20/pk



BUY NOW

Microscopes & Accessories

Deluxe Microscope w/Plan Objectives

A deluxe version of the Revelation III, this microscope has all the same features plus the following upgrades:

- Objectives are plan giving increasing clarity of the image especially on the fringes
- Super-wide eyepiece tube of 30mm provides a huge field of view
- Larger and modern looking frame
- Larger mechanical stage, 160mm x 140mm

JOR334MP \$1,710.00/ea

Binocular LabScope

JOR334MY \$1,495.00/ea

Binocular LabScope w/Plan Objectives

JOR334M2P 10,40,50,100X \$1,450.00/ea

Binocular Microscope

JOR334M5P (10,20,40,50, 100X) Objectives \$1,880.00/ea

M5 Trinoc Labscope

JOR334M5PTL with LED Light \$2,230.00/ea

Binocular Scope w/Phase Turret

JOR334M2PX 10,40,50, & 100X \$2,310.00/ea

Binocular Microscope with Phase Turret

JOR334MPP \$2,500.00/ea

Accessories

Microscope Objective 50X Oil

JOR334MPD2 \$359.00/ea

Objection Lens DIN Plan 20x

JOR334MPD20 \$154.00/ea

Hard case for JOR334MP and JOR334MS

Custom Carrying Case for JOR334mp and JOR334ms labscopes. Durable metal construction. Secured with lock, comes with 2 keys.

JOR334MC \$180.00/ea

BUY NOW

Eyepiece W/ Pointe (for M series only)

Eyepiece with pointer (JOR334mp series)

JOR334MEP \$81.20/ea

10X Phase Contrast Kit

JOR334PCA \$410.00/ea

40X Phase Contrast Kit

JOR334PCB \$410.00/ea

100X Phase Contrast Kit

JOR334PCC \$410.00/ea

Bulb only

JOR334D1 \$13.50/ea

Infinity LabScope

This new model has a beautiful design with a number of important features.

- Infinity optics usually found only on very expensive microscopes. Best optical system for highest clarity and resolution.
- LED illumination: gives bright almost daylight illumination with very long-lasting bulb, with cool temperature
- 4 semiplan objectives, flat field across 95% of your view
- 10x/20 super wide high-point eyepieces, higher focal point means you can wear glasses and see more of your specimen at each magnification power.
- Ergonomic design
- Can rest your arms and hands flat on the table with all controls in easy reach.
- Optional 50x oil infinity objective
- The highest resolution objective available, which doubles the view of the 100x oil for faster scanning and counting.

JOR334Q \$1,204.00/ea

Infinty Trinocular LabScope w/Phase Kit

JOR334TP \$2,600.00/ea

Infinity Binocular Labscope w/Phase Kit

JOR334BP \$2,390.00/ea

Infinity LabScope Carrying Case

JOR334QC \$199.00/ea

Inspector Zoom Dissecting Microscope

A high resolution stereo zoom microscope, also called a dissecting microscope, with both lower (transmitted) and variable upper (reflected) illumination. Its clean 3D imaging and broad field of view make it perfect for selecting viable embryos. Use the lower transmitted, dim the upper light, and zoom the magnification from 6.5x to 45x to see the structure and condition of each embryo. High magnification options up to 72x or 90x are available. Frosted glass stage with two holding clips.

JOR755 \$1,100.00/ea

Jorvet

BUY NOW



Semen Evaluation LabScope

BUY NOW

Semen Evaluation LabScope, is perfect for veterinarians interested in live specimen microscopy including: semen evaluation, live biological specimen analysis, and standard brightfield applications. Motility analysis should be performed at 37°C to keep sperm active. The heated stage has a digital temperature control unit permitting temperature settings between 25-50°C and maintains accurate and stable temperatures within +/-0.5° during observation. Unplug the cord from the stage, and the LabScope looks and functions like a standard laboratory-grade microscope. The PLAN phase objectives and turret condenser allow flatfield, high contrast viewing of live, unstained specimens, and easy magnification changes

with the flip of the thumb. Simply turn the turret condenser wheel to switch between brightfield, darkfield, phase 10x, phase 40x, and phase 100x settings. System Features:

- Laboratory binocular microscope
- 10x/20 high-point, oversized WF eyepieces
- Complete semen evaluation system
- X-Y mechanical stage for precise slide movements
- Built-in heated stage with removable cord
- Variable digital temperature control 25-50°C
- Set temperature in 1° increments
- Displays actual temperature in 0.1° increments
- Accurate within 0.5°C
- Reaches temperature with 1-2 minutes
- Switchable power input 110V or 220V AC
- Digital temperature control unit
- 84mm (3.4" W x 225mm (9" L x 153mm (6.5" H)
- 2.5 kg (5.5 lbs.)
- Turret condenser with phase contrast and brightfield
- PLAN flat-field phase contrast - Phase 10x, Phase 20x, phase 40x, phase 100x
- DIN PLAN flat field objectives
- Variable halogen 20 watt Koehler illumination
- Includes blue-green-yellow filters, immersion oil, dust cover & manual
- Microscope specifications
- 200mm (77/8" W x 270mm (105/8" L x 420mm (161/2" H)
- 9kg (20 lbs.)
- 110V or 220V AC power
- Lifetime warranty on mechanical and optical components,
- 1-year warranty on electrical components



JOR334X		\$3,989.00/ea
JOR334XC	Case for JOR334X	\$199.00/ea
JOR334XP	Without heated stage.	\$2,050.00
JOR334XS	Microscope heated stage only	\$1,420.00/ea
JOR334XT	Trinocular Head with Camera Connections (optional)	\$4,200.00/ea

Phase Contrast (option package)

BUY NOW

JOR334PC \$1,400.00/pk

Microscope, Portable (w/battery)

JOR334P \$750.00/ea

BUY NOW

Phase Contrast Kit

JOR334MPC \$1,080.00/ea

BUY NOW

Reticle

Reticle for JOR334mp series

JOR334MPD4 \$58.00/ea

M5 LabScope w/Trinocular C-mount Oil Objectives

JOR334M5PT \$2,140.00/ea

BUY NOW

Trinocular Head Laboratory Microscope

This is the deluxe microscope with video imaging capabilities. It comes with a C-mount for a variety of camera attachments. It can be used with the JorVet BioVID camera for live video or any standard digital camera for still images.

- Excellent for educating clients, technicians, and sharing information with colleagues.
- Able to capture images without disrupting binocular viewing.

JOR334MPT \$2,250.00/ea

BUY NOW

Trinocular Infinity LabScope

JOR3340T \$1,369.00/ea

BUY NOW



Trinocular LabScope w/ C-mount

JOR334MX \$2,100.00/ea

Trinocular LabScope w/c-mount phase turret

JOR334M2PTX \$2,500.00/ea

Trinocular Repro

BUY NOW

A number of different microscopes can be combined with a camera system. the camera system is then connected to a monitor or computer.

JOR333D Trinocular Semen evaluation Labscope with phase contrast and heated stage with BioVid camera \$4,200.00/ea

Trinocular Scope

BUY NOW

JOR334M2PT w/C-mount Objectives, 10,40,50,100X \$1,780.00/ea

Trinocular with Phase Turret

JOR334MPPT \$2,800.00/ea

Trinocular Scope

BUY NOW

A number of different microscopes can be combined with a camera system. the camera system is then connected to a monitor or computer.

JOR333B (50 X oil) with Biovid camera \$2,550.00/ea
 JOR333C Trinocular Labscope with 10x, 20x, 40x, 50x oil, and 100x oil objectives with BioVid camera \$2,850.00/ea

Trinocular scope w/Biovid camera

A number of different microscopes can be combined with a camera system. The camera system is then connected to a monitor or computer.

JOR333A \$2,380.00/ea



Revelation III Microscope & Pulse Oximeter

Revelation III Microscope

Revelation III Microscope is an improved version of our previous model "Revelation." Excellent for the veterinary in-clinic laboratory. Use for fecal floatation on 10x to cytology on 100x oil immersion.

Mechanical stage with coaxial controls (140mm x 140mm)
Binocular head with wide field 10x eyepieces
Four DIN achromatic objectives: 4x, 10x, 40x, and 100x.

- Moveable ABSE condenser N.A. 125
- 12V 20 watt halogen bulb
- Fine and coarse focus adjustments
- Dust cover
- Inexpensive

JOR334A	Complete	\$960.00/ea
JOR334AT	Trinocular head, Optional	\$400.00/ea
JOR334AC	Hard Carrying Case for Rev III Microscope.	\$105.00/ea
JOR334ACS	Soft Carrying Case for Rev III Microscope.	\$61.00/ea
JOR334AD1	Digital camera adaptor for microscope	\$97.50/ea
JOR334AD2	Reticle for Rev III microscope.	\$69.00/ea



BUY NOW

Veterinary Pulse Oximeter with Thermistor

Measures oxygen saturation and temperature. Small pulse oximeter with adjustable alarms and LED display that runs continuously. Includes a lingual sensor and rectal sensor with thermistor.

- Intended for continuous pulse oximetry
- Portable with alarms and two LED displays 12-hour NiCad or continuous AC-powered operation
- Adjustable pulse tone levels
- Pitch changes with rise or fall in oxygen saturation
- Adjustable alarm levels for oxygen saturation and pulse rate
- Previous alarm settings are recalled from memory
- Output port for data communication to other instruments. Unit has a five year warranty and sensors each have a 1 year warranty.



340V Model 340V \$795.00/ea **BUY NOW**

Revelation 3 microscope with MiniVid RCA

A number of different microscopes can be combined with a camera system. the camera system is then connected to a monitor or computer.

JOR333X \$1,050.00/ea

BUY NOW

Revelation 3 microscope with MiniVid USB

This is the deluxe microscope with video imaging capabilities. It comes with a C-mount for a variety of camera attachments. It can be used with the JorVet BioVID camera for live video or any standard digital camera for still images.

- Excellent for educating clients, technicians, and sharing information with colleagues.
- Able to capture images without disrupting binocular viewing.

JOR333Y \$1,185.00



BUY NOW

Replacement Sensor for Medi-Aid 340V Pulse Oximeter

SENS-MEDIAID-L	Lingual, 9ft Cable	\$160.00/ea
SENS-MEDIAID-R	Rectal, 9ft Cable	\$160.00/ea

Pulse Oximeter Universal Lingual Sensor for Nellcor

CST090-51209	Lingual, 9ft Cable	\$95.00/ea
CST080-51209	Rectal, 9ft Cable	\$105.00/ea

Pulse Oximeter Universal Lingual Sensor for Nonin

CST090-51259	Lingual, 9ft Cable	\$95.00/ea
CST080-51259	Rectal, 9ft Cable	\$105.00/ea

Pulse Oximeter Universal Lingual Sensor for Surgivet

CST090-51049	Lingual, 9ft Cable	\$95.00/ea
CST080-51049	Rectal, 9ft Cable	\$105.00/ea

TonoVet

The use of tonometry to measure Intra Ocular Pressure (IOP) is the only real tool for the screening of glaucoma. Traditional tonometers determine pressure by repeatedly pushing an instrument against the cornea and calculating the force necessary to flatten the cornea. The TonoVet uses a newer technology called "rebound" tonometry. The portable hand held unit is positioned 1/4" away from the cornea. At the push of a button, a tiny probe painlessly and rapidly reaches out and touches the cornea. Six rapid measurements are taken in seconds! The unit is self-calibrating with its own software and it is the size of a cell phone. It has been approved for use on all veterinary patients. It has a limited four year warranty. It runs on 4 AA batteries and has a measurement range of 1-99 mm Hg.

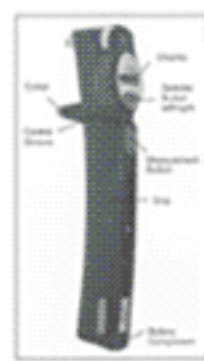

JOR1000 Complete unit with 100 extra probes and a storage case. \$3,260.00/ea
JOR1000D1 100/pack Probes \$166.00/pk



MEDIAID

Diagnostic Tests

Reagent Strips

BUY NOW

High quality test strips at affordable prices. Large Selection of test strip configurations. Easy to read color chart. Uniform read times.

D10 10 Tests, Glucose, Protein, Ketone, pH, Blood, Bilirubin, Urobilinogen, Nitrite, Specific Gravity, Leukocytes 100/Btl \$39.95/ea



Vet-10 Urine Reagent Strips

These urine test strips offer two major advantages:

- Veterinary specific: for urine specific gravity these strips allow values for what veterinary medicine requires
 - Priced at considerable savings over other brands
- These test strips are a high quality grade product made in the USA. The 10 colors on the strip are configured in the same order as the Ames Multistix-10B to avoid confusion and maintain continuity.

The expanded test strip now has the 10th test for leukocytes. 100 test strips per bottle. The strips test for: 1. Nitrite 2. Urobilinogen 3. Protein 4. pH 5. Specific Gravity 6. Ketone 7. Bilirubin 8. Glucose 9. Blood 10. Leukocytes

JOR630X 100/pk \$44.00

BUY NOW



Vet-BUN Reagent Strips

These sensitive color-coded test strips use one drop of whole blood to give blood urea nitrogen (BUN) reading. They are a quick and simple screening test for this important blood parameter. Made in the USA.

JOR630Y 25 strips per bottle. \$27.00/ea



Urine Reagent 5

BUY NOW

- Tests for:
- Blood
 - Ketone
 - Glucose
 - Protein
 - pH

JOR630V 100 pack \$28.50/ea



pH Indicator Paper

JOR892 w/pH range 4-9 \$8.40/ea

pH Indicator Strips

JOR893 w/pH range 5-9 \$17.10/ea

BUY NOW



Jorvet Ketone Urine Test Strip

Ketone-Only Test Strip. Screening for ketosis in cattle and sheep.

JOR630K \$10.50/ea

BUY NOW

Jorvet Glucose Urine Test Strip

Glucose-Only Test Strip. Suggested for monitoring diabetic cases.

JOR630G 100 pack \$12.00/ea

BUY NOW



Fecatector Diagnostic Kit

A unique, sanitary, leak-proof collection device, to be used by the client for obtaining fecal samples from pets. The same container then doubles as the laboratory flotation device. This eliminates the need for technicians to transfer or contact the stool sample. Comes complete with laboratory instructions card and easy-to-follow client instruction sheets. Comes in a compact display box for wall-mounted or counter use.

606-2799 50 kits per box \$17.99/bx 6+\$15.99/ea



BUY NOW

Zinc Sulfate Fecal Flotation Medium

RXDNA-GAL 1 gallon

\$10.99/gal

BUY NOW

Fecal-Ova Float Kit

A fecal flotation exam is a necessary part of every routine physical exam as well as many diagnostic workups. Various internal parasite eggs can be detected through this simple test by the use of flotation solutions, which cause the ova to rise to the top of these solutions. Often times, the client is asked to bring a stool sample from home, which is not an easy task in most cases. The fecal ova float is a two-part plastic container for use as both a fecal collection container and a flotation exam container. The inexpensive containers facilitate a simple and hygienic collection of fecal material. Containers will hold the flotation solution, with no spillage, for a flotation exam. Packaged in handy 50-kit dispensing

JOR950 Fecal Ova Float, Dispensing Box with 50 Kits. 7 1/2" x 5 1/2" x 5" \$22.50/ea

Fecal-Ova Float Refill

JOR950B Fecal Ova Float. 50 Kits/Bulk. (dispensing box not included) \$21.75/bx



BUY NOW



Con-Trade[®] Fecal Filters

BUY NOW

Contrade fecal filters are especially useful when used in conjunction with swing arm centrifuges for fecal exams. The filter is designed to seat on top of conical test tubes. It is used to filter out particulates and debris from fecal solution after the flotation solution has been mixed with the sample. The contrate fecal filter helps eliminate messy spills and is a good substitute for gauze sponges or tea bag strainers.

JOR952 5/pk. Tray not included. \$13.80/pk



Disposable Polystyrene Tube

Conical shaped tube with graduations.

BUY NOW

JOR546A Disposable Polystyrene Tube. 15ml. 100/box \$12.60/ea



Blood Flow Monitor

Doppler Ultrasonic Blood Flow Monitor

Hypertension (high blood pressure) is often overlooked during diagnosis, treatment and routine physical exams in small animals. In addition, many hypotensive (low blood pressure) patients, such as those suffering from shock, benefit greatly from Doppler measurement of blood pressure when knowing the pressure can mean effective and timely treatment. Combining Doppler with an appropriate size "cuff" for small animals, provides the veterinarian with the same non-invasive method for testing blood pressure as is available in human medicine. A small probe is placed over a peripheral artery, e.g., digital or coccygeal. An ultrasonic crystal in the probe transmits pulse wave sounds back to the amplifier. The pressure cuff is then placed proximal to the probe. The cuff is inflated until the pulse sounds are no longer audible. The cuff is slowly deflated, using the manometer, until pulse sounds are audible once more, at which point the manometer displays a numeric value of the animal's systolic pressure.

JorVet

Features:

- Lightweight, hand-held unit
- High quality, veterinary-specific "cuff" (sphygmomanometer)
- Comes with two cuffs (2.5 cm and 5.0 cm)
- Run on 9-volt battery, included
- Complete with carrying case



JOR563 Complete with case \$1,060.00/ea

Jorvet Disposable Blood Pressure Cuff

These cuffs are made from a soft white vinyl. They feature a Velcro closure and will fit all models of blood pressure measurement systems. A single tube. Made in the USA, and inexpensive. White. 5/pk.

Proper Size is 40 percent of the circumference of the limb when the cuff is being applied. These sizes should cover just about all small animals. Cuff size ranges in centimeters.

JOR5630	3.5cm W. 9.6-14.3 L.	\$46.50/pk
JOR563R	3.0cm W. 8.5-12.7 L.	\$46.50/pk
JOR563S	2.5cm W. 7.2-10.7 L.	\$46.50/pk
JOR563V	One of each size	\$46.50/pk

JorVet

Microhematocrit Capillary Tubes

BUY NOW

These capillary tubes are designed for both safe blood collection as well as an accurate microhematocrit determination. Precision molded, they provide excellent sample retention during centrifugation. Tubes fill rapidly without affecting specimen integrity. Tube 1.15mm i.d. x 1.55mm o.d. 75mm length. Packaged in a protective snap cap vial. 100 tubes/vial/10 vials/cs

JOR543 Red Tip, Heparinized Tube, 100/vial \$34.50/cs

JorVet

Jorvet Capillary Sealant Tray

Leak-tight sealant formed quickly from unique compound designed to withstand centrifugation. Non-toxic, non-drying, non-hardening.

JOR545 Tip resistant tray for upright storage of 24 tubes. \$6.90/ea

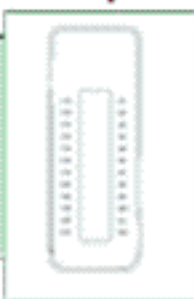

BUY NOW

Alkaline Battery

BUY NOW

BAT-AA	Size AA 24/Bx	\$7.95/bx
BAT-C	Size C 6/Pkg	\$1.99/pk

JOR563

BUY NOW



Headset for Doppler

JOR563D8 \$30.00/ea **JorVet**

Doppler Sphygmomanometer

JOR563D3 SPHYGMOMANOMETER ONLY \$136.00/ea

Doppler Cuff

JOR563D4	2.5cm	\$54.00/ea
JOR563D5	5.0cm	\$45.00/ea
JOR563D6	7.5cm	\$45.00/ea
JOR563D7	10.0cm	\$80.00/ea

JOR563D



Doppler BP Cuff 1.9cm

Cuff only 1.9cm.
JOR563D4A \$54.00/ea **JorVet**



Microhematocrit Reader Card

BUY NOW

A laminated chart necessary for determining PCV values from hematocrit tubes. (not pictured)

BUY NOW

JOR501RC \$15.00/ea

JorVet

Clinical Refractometer

BUY NOW

A high-quality clinical hand-held refractometer for quick and accurate urine specific gravity plus serum total protein measurements. Adjustable focus. Comes with protective case.

JOR351 7" With Case

\$195⁰⁰/ea



MAGNIFIERS & NEBULIZERS & LUMIVIEW™



Intelect® Transport Ultrasound

Therapeutic ultrasound provides deep tissue-heating to treat musculoskeletal injuries, as opposed to superficial heat treatment. Ultrasound also delivers non-thermal pulse down effects. The combination of deep heating and non-thermal effects makes this a unique and versatile therapy. This unit is transportable featuring logical control system; a large easy-to-read graphical LCD display, and user defined protocols. **FEATURES:** Ergonomically designed applicators, 10cm² head size for equine patients, fully functional 1 and 3.3MHz frequencies, pulsed and continuous therapy, head warming function on applicators, two year warranty on unit, 90 days on sound heads.

Jorvet

BUY NOW

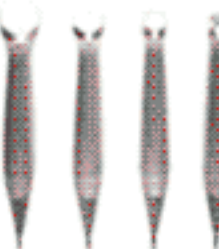

JOR1015ED1 10cm Ultrasound applicator head \$342.00/ea

Ultrasound Gel

BUY NOW

An aqueous coupling medium for diagnostic and electrical/medical procedures.

TRANS-GELSL 5 Liter w/ 9 oz dispenser bottle \$24.99/ea

Ultrasound gel

BUY NOW

An aqueous coupling gel for both diagnostic and therapeutic procedures (i.e., ultrasound or doppler).

UGEL-80Z 8oz Ea \$3.99/ea
 JOR554 8 oz. bottle \$5.10/ea
 JOR554B 5 liter bulk \$27.00/ea



Jorvet Optivisor®

BUY NOW

Jorvet

Optivisor is a precision binocular headband magnifier which permits unrestricted user efficiency—leaving both hands free, while reducing eye strain—allowing three dimensional vision. It can be worn over prescription eyeglasses. Equipped with these unique features:

- Optical glass prismatic lenses. Ground and polished to precision optical standards.
- Bevel edged and mounted in interchangeable plastic frame.
- Adjustable pivots allow the visor to be tilted out of the way when not in use, and at your fingertips when magnification is needed.
- Adjustable headband conforms to fit all head sizes. Fabricated from a special blend of lightweight material. Comfortable when worn for long periods of time.
- High impact visor is tough, durable, and always new in appearance.
- Genuine leather comfort band is padded with orthopedic felt to add comfort.
- Magnifies 2.5 times at 8".
- Optivisor is perfect for eye exams, (i.e. corneal foreign body, distichiasis). Varying magnifications and focal lengths available:

JOR801 2 1/2 X at 8" \$66.00/ea
 JOR801B 1 3/4 X at 14" \$66.00/ea
 JOR801C 2 X at 10" \$66.00/ea
 JOR801D 2.75 X at 6" \$67.50/ea
 JOR801E 3.50 X at 4" \$67.50/ea



Jorvet Optiloupe®

BUY NOW

- An attachable lens that adds the additional power of an eye loupe to the Optivisor.
- Designed for monocular use and easily flips up or down providing additional 2 1/2 X magnification.
- Easily attached to either eye of Optivisor.

JOR801L 2 1/2 X magnification \$15.00/ea

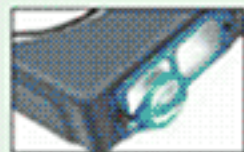

Replacement Lens Plate

Only for optivisor. These lenses interchange by removing two screws.

BUY NOW

JOR801LPA 1.5 Magnification, 20" Focal Length \$45.00/ea
 JOR801LPB 1.75 Magnification, 14" Focal Length \$45.00/ea
 JOR801LPC 2 Magnification, 10" Focal Length \$45.00/ea
 JOR801LPD 2.5 Magnification, 8" Focal Length \$45.00/ea
 JOR801LPE 2.75 Magnification, 6" Focal Length \$46.50/ea
 JOR801LFF 3.5 Magnification, 4" Focal Length \$46.50/ea

Head Magnifier

BUY NOW

Head Lighted Multi-Power Head Magnifier includes:

- Both side light attachment (4 AAA batteries, not included).
- Light weight, approx: 1/4lbs.
- Coated acrylic lens.
- Easy self-locking adjustable head strap with swivel head.
- Wide body, can be used while wearing reading glasses.
- Multiple magnification from: 2.2x to 4.8x with 3 lens/loupe, fixed lens, flip lens 1.1x, loupe 1.5x.
- Clean with soft lint free cloth with natural cleaning agent.

Head Magnifier Multi-Power (Loupe) includes:

- Light weight, approx: 1/4lbs.
- Coated acrylic lens.
- Easy self-locking adjustable head strap w/swivel head.
- Wide body, can be used while wearing reading glasses.
- Multiple magnification, from: 2x2 to 4.8x with 3 lens loupe, fixed lens 2.2, flip lens 1.1x, loupe 1.5x
- Clean with soft lint-free cloth with natural cleaning agent.



MH1042C Head Magnifier-not lighted \$29.95/ea
 MH1043C Head Magnifier- Lighted \$34.95/ea

Visor Head Light

BUY NOW

Provides hands-free light where you need it. Pack mounted on head band. Xenon laser beam emits 6000 candle power. Operates ~5-6 hours with 2 AA batteries.

JOR801V Head Light \$39.00/ea



Visor Sold Separately

Visor Light Replacement Bulb

JOR801VD1 2 pack \$20.40/pk

Centrifuge Tube

BUY NOW

Conical shaped tube with graduations. **Jorvet**

JOR546A Disposable Polystyrene Tube. 15ml. 100/box \$12.60/ea

Lights; Ultraviolet, Wood's & Pen



Ultraviolet Light

BUY NOW

- Special fluorescent bulbs produce UVA at approximately 360 nm wavelength.
- Available with magnifier and white bulbs.
- 4-light magnifier models include optically ground and polished glass 5 diopter magnifier lens with 2.25X total power magnification and focal length of 8".
- 6,000 hour average bulb life.
- 5-year warranty. Made in the USA.

UV503 U.V Woods Light \$485.00/ea



Jorvet Ultraviolet Wood's Light 220v

BUY NOW

- A hand-held lamp with 220V plug-in. High impact plastic housing.
- Ultraviolet light at wavelength of 365nm with intensity of 180uW/cm² at 6"
- 7 5/8" x 2 7/8" x 2". 1 lb.
- 4-watts

JOR3120F 4 watt, 220-volt \$151.00/ea
 JOR312SF 6 watt, 220V \$199.00/ea

Jorvet Ultraviolet Wood's Light 110v

- A hand-held lamp with 110V plug-in. High impact plastic housing.
- Ultraviolet light at wavelength of 365nm with intensity of 180uW/cm² at 6"
- 7 5/8" x 2 7/8" x 2". 1 lb.
- 4-watts

JOR312Q 4 watt, 110V AC \$151.00/ea
 JOR312QB Replacement bulb for 4 watt light \$36.40/ea

Ultraviolet Wood's Light

- Uses 110V plug-in.
- Ultraviolet light at wavelength of 365nm
- 14 9/10" x 3 9/10" x 2 1/2". 2 lbs.
- 6-watts

JOR312S 6 watt, 110V AC \$199.00/ea
 JOR312SB For 6 watt light Bulb Only \$37.50/ea

Woods Light

BUY NOW

UV59B Bulb \$13.00/ea
 UV59 Light w/bulb \$63.00/ea

Replacement Bulb for Portable Woods Light.

JOR312B Replacement Bulb for Portable Woods Light. \$18.00/ea

Disposable Pen Light

Lightweight penlight for a variety of hospital uses. Selected pinpoint bulbs for high intensity. Clips easily onto your pocket.

JOR315 6/pk. \$21.00/pk

Halogen Penlight

The JorVet Penlight with halogen bulb offers 400 percent more candle power than standard penlights.

JOR114BH Uses two "AA" batteries, included. \$33.00/ea



Jorvet White Slit Light

JorVet

Designed with a high intensity white slit for cataract evaluation, checking the anterior chamber or for corneal edema.

JOR314A AA batteries included. \$51.00/ea

BUY NOW

Jorvet Endolight

BUY NOW

New and improved, this small penlight has an attached flexible metal rod with a small wheat-head-size bulb. A small endotracheal tube 5mm easily slides over the rod. Gives rigidity and great illumination when intubating small dogs and cats. Makes a small keyhole task simple.

JOR167Q Operates on "AA" batteries (included). 10" shaft. \$48.00/ea
 JOR167Q01 Bulb only \$10.80/ea

Scales



Standard Measurement Unit Shown



Portable Pediatric Scale (A)

Accurate weights of your smaller patients are important. Small changes in weight can indicate disease. An accurate weight is also important for proper dosing of medication plus your clients like to know their animal's weight. Tray dimension: 10 1/2" x 21 1/2". Scale dimensions: 10 1/2" x 10 1/2" x 11 1/2"

- Accurate, instant and easy-to-read LED display, 4 digits 1 1/2" high
- Lock-in weight with zero/tare function
- Automatic power off function
- 44 lbs. (20 kg) capacity
- Graduation: 0-20 lbs. x 1 oz. (0-10kg x 20g); 20-44 lbs x 2 oz. (10-20kg x 50g)
- Uses 4 AAA batteries (included)

J0R825 Portable, 5.5lb \$169.00/ea

Portable Mechanical Pediatric Scale (B)

The Health O Meter portable mechanical pediatric scale is well suited to the medical environment. The sanitary tray provides maximum safety, and the poise beam is easy to read. This scale reads in kgs. Drop ship charges may apply

386S01 Standard Weight, 50 lb. Cap. \$149.00/ea
386KGS01 Metric Weight, 26 kg. Cap. \$149.00/ea

DISCONTINUED Portable Pet Scale (C)

Easy Read® LCD display with weight hold and auto shut-off after 5 minutes. 7" x 8 5/8" stainless steel platform. 6 lb. capacity. Includes rechargeable battery (50 hour in use) and 120V AC adapter/re-charger. One year limited warranty.

FS6 7" X 8 5/8", 6lb capacity \$396.00/ea

Electronic Pet Scale (D)

The Health O Meter 522KL Digital Pediatric Scale has a capacity of 50 Lbs with .2 Ounce Accuracy. It is EMR ready, and has a built-in measuring tape to simplify the height and weighing process. This digital tray scale also includes full tare / zero functions. Drop ship charges may apply.

522KL Digital Pediatric Tray Scale, 50 lb. capacity \$352.00/ea

Digital Pediatric Scale (E)

The Health o Meter 553KL digital baby scale is a high performance digital pediatric scale with motion-sensing technology to capture the weights of even the most active babies. For the baby's comfort and safety the Health o Meter 553KL digital baby scale offers a large and stable weighing tray with raised edges. Other features of the 553KL include auto-off, auto-zero and low battery indicator as well as the ability to weigh in kilograms and pounds/ounces. Drop ship charges may apply

553KL Digital Pediatric Scale, 44 lb. weight capacity \$311.00/ea

Digital Physicians Scale (F)

This electronic physician scale comes standard with an RS232 interface, allowing you to connect it to a computer to export data. There is also a 24"- 84" x 1/8" "Silent Slide" height rod for measuring a patient's height at the same time you measure their weight. Drop ship charges may apply.

597KL Digital Physicians Scale W Measuring Rod, \$622.00/ea
600 lb. capacity

Elite Floor Standing Electronic Scale (G)

Elite Floor-Standing Lateral, Regal 300 Electronic Scale Lift Table 12661-01-62LWEF \$3,650.00/ea
Elite Floor-Standing Lateral, Regal 300 Electronic Scale Lift Table

Electronic Pro Series Veterinary Scale (F)

Designed for time-saving, convenient operation. Has remote electronic control indicator with bright, easy-to-read LED display, auto zero, push-button tare and weight lock-in with pound/kilo readings. A significant breakthrough in sensitivity and exacting accuracy compensates for animal movement. Quality construction for long-term dependability. Rugged stainless steel 42" x 22" x 1.5" platform. Includes rechargeable battery, 120V AC adapter/recharger and removable grey mat for easy cleaning. Full two year warranty, full one year warranty on battery.

2842KL Pro Series, 600lb capacity \$1,157.00/ea F





ECG Machines & Blood Pressure Unit

Physicians Balance Beam Scale (H)

The 402KL Physician Beam Scale offers an astonishing 500 lb (200 kg) capacity with 1/4 lb (100 g) graduation when used with the included additional counter weights. The 402KL scale reads in either pounds or kilograms, just rotate the easy to read poise bars with a twist of the wrist. The poise bars have permanent, engraved numerals, and are powder coated inside and out for long life. The heavy duty 10 1/2" by 14" steel platform is strong and durable with ample foot room and an ABS plastic platform cover for easy cleaning. The 402KL Physician Balance Beam Scale also features a professional dual read height rod for monitoring growth. The smoothly operational height rod measures in 1/8" (1 mm) increments and has a measuring range of 23 5/8" (60 cm) to 84" (213 cm). This fine scale comes to you factory calibrated to ensure accuracy. And now with an incredible new 10 Year Warranty! Drop ship charges may apply.

402KL Physicians Balance Beam Scale W/ Height Measuring Rod, 500 lb. capacity \$244.00/ea

Portable Digital Baby Scale (I)

The Health-O-Meter 549KL Digital Baby Scale has an easy to clean sanitary tray and a 44 pound maximum capacity. The 549KL operates on one 9 volt battery. Other features include a 2 minute auto-off function and a 2 minute auto-hold to display the weight after the baby has been removed from the scale. Drop ship charges may apply

549KL Portable Digital Baby Scale, 44 lb. weight capacity \$197.00/ea

Jorvet Cardiofax ECG **BUY NOW**

Cardiofax GEM ECG-9020K is a multi-channel interpretive electrocardiograph which incorporates a large waveform display and recorder in a compact and lightweight package.

- Features:
- Large LCD
- Special ECG analysis program
- Operable with AC and Battery Power
- Easy Operation
- Paper saving recording
- Compact body



JOR851 ECG Unit \$3,390.00/ea

Jorvet Cardiofax Paper **BUY NOW**

JOR851-D 100 sheets, 20 printouts. \$17.60/H

Televet ECG Electrodes

JOR1002D1 \$21.60/ea

Dura Stick II Electrodes

JOR1014D3 1 1/4" round \$96.00

JOR1014D4 2 3/4" round \$96.00



Jorvet **BUY NOW**

ECG Machine **BUY NOW**

The ECG is one of the most under utilized diagnostic parameters in veterinary medicine. An ECG is an absolute necessity for proper cardiac diagnostics. The Jorvet Single Channel ECG and monitor offers what veterinarians need at a very reasonable price. The all-important lead II rhythm strip can be run for screening purposes; and if further evaluation is deemed necessary, all 6 common leads can be run for more thorough diagnostics.

Features and Benefits:

- One touch keypad buttons allow for easy set up and operation
- Large screen is well lit and easy to read
- Single channel displays and prints one lead at a time
- Features both MANUAL and AUTO modes
- Dimensions are 12"L x 87/8"W x 25/8"H
- Weighs just 6.25 lbs
- Operates on either AC or 12 volt NiMH rechargeable battery
- Patient comfortable electrode clips
- Built in paper printer
- Supports patient monitoring via onscreen tracing, i.e., lead II
- Supports diagnostic evaluation via the printed tracing
- 3 year warranty on the ECG unit, 1 year on battery and leads

JOR1010 12"L x 87/8"W x 25/8"H \$1,080.00/ea



ECG Paper Rolls

JOR101003 Extra (each) \$4.50/ea

Jorvet



Schiotz Tonometer **BUY NOW**

The most economical method for measuring ocular pressure. Kit comes complete with conversion chart and storage case.

JOR506 German-made.

\$210.00/ea

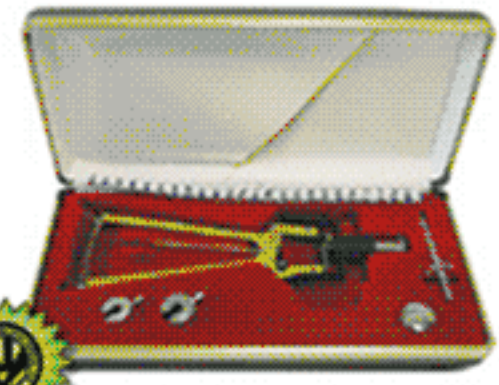

Jorvet

Vet Tech Kit **BUY NOW**

Included in the soft side zipper pouch:

- 1 Stethoscope
- 2 Pen Lights
- 1 2-130
- 1 2-145
- 1 4-510
- 1 4-511
- 1 Nye Model Tourniquet

VETTECHKIT 8 piece \$29.95/ea



Biocam 2.0 -

Biocam 2.0 Video Otoscope

- JOR1100 Video Otoscope Includes Includes software **BUY NOW** \$940.00/ea
- 3 interchangeable speculums
 - 4 speculums with working operating channel
 - Optical Format 1/4.5 inch VGA CMOS
 - Sensor Resolution 660H X 507V, 334,620 pixel
 - Effective Pixels 640H x 480V, 307,200 pixel
 - Camera Function Live & capture, record, focus
 - Sensor Pixel Size 3.6 m x 3.6 m
 - One Year Limited Warranty on Parts & Labor.

Biocam 2.0 Accessories Disposable Speculum

- BUY NOW**
- | | | |
|------------|-----------------------------|------------|
| JOR1100012 | Small, 3mm x 32mm, 50/pk | \$34.50/bx |
| JOR1100013 | Medium, 4.6mm x 45mm, 50/bx | \$34.50/bx |
| JOR1100014 | Large, 5.2mm x 52mm, 50/bx | \$34.50/bx |

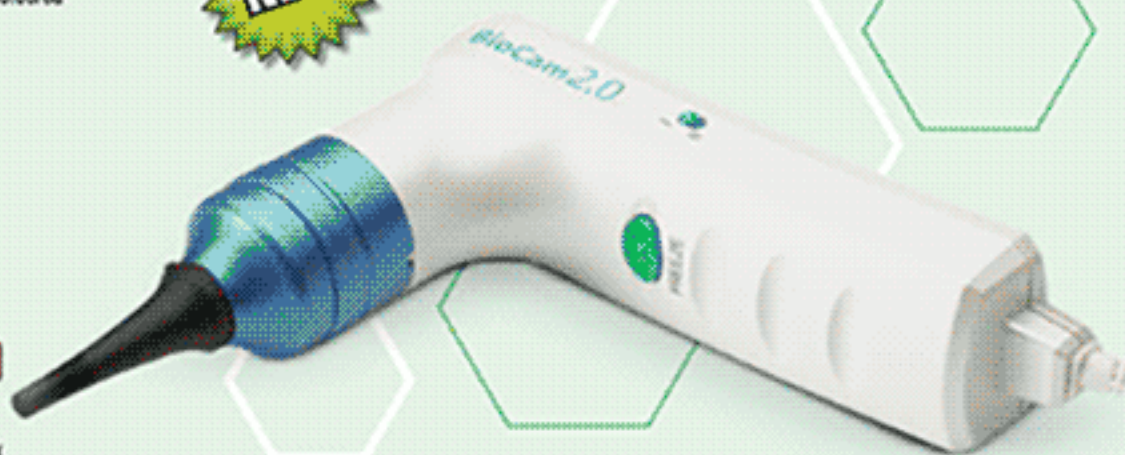

The New Revolution in clinical diagnosis

INTERCHANGEABLE SPECULUM



FOCUS DIAL

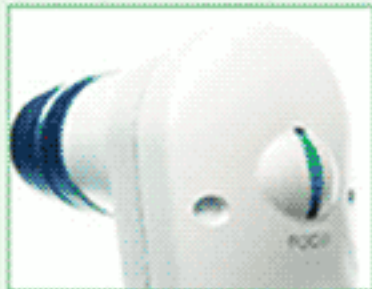

FREEZE BUTTON

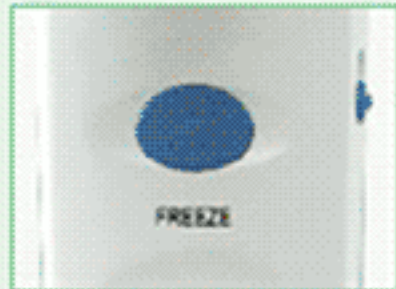

USB PORT



The portability and high-resolution imaging and video recording make clinical diagnosis simple and practical. It educates the client in understanding the process resulting in increased compliance. This one of a kind video otoscope has multi-use capabilities in one device. Designed with precision and cutting edge technology. Features:

- **Portable.** This device can be plugged into any Microsoft platform computer with a USB2.0 port.
 - **Power.** No batteries or external power source is needed. It is powered through the USB port.
 - **Light Source.** 6 LED bulbs allow 10,000 working hours.
 - **High Resolution Imaging and Video Capture.** The Bio-Cam 2.0™ with a quad VGA of 1280H x 960V, 15fps creates sharp and accurate imaging for easy diagnosis. The BioCam 2.0™ also records real-time video through live capture.
 - **Multi Usage.** With its live capture, easy one-touch record and focus functions, the BioCam 2.0™ allows before and after imaging. It is capable of being used for multiple diagnosis as in skin lesions, dental tartar, ear infections and more.
 - **Interchangeable Speculum.** Interchangeable disposable speculums offer medical professionals more flexibility for diagnosing. The portability and high-resolution imaging and video recording make clinical diagnosis simple and practical. It educates the client in understanding the process resulting in increased compliance. This one of a kind video otoscope has multi-use capabilities in one device. Designed with precision and cutting edge technology. Features:
 - **Portable.** This device can be plugged into any Microsoft platform computer with a USB2.0 port.
 - **Power.** No batteries or external power source is needed. It is powered through the USB port.
 - **Light Source.** 6 LED bulbs allow 10,000 working hours.
 - **High Resolution Imaging and Video Capture.** The Bio-Cam 2.0™ with a quad VGA of 1280H x 960V, 15fps creates sharp and accurate imaging for easy diagnosis. The BioCam 2.0™ also records real-time video through live capture.
 - **Multi Usage.** With its live capture, easy one-touch record and focus functions, the BioCam 2.0™ allows before and after imaging. It is capable of being used for multiple diagnosis as in skin lesions, dental tartar, ear infections and more.
- Interchangeable Speculum. Interchangeable disposable speculums offer medical professionals more flexibility for diagnosing.*



Respirator/Alarm & Vagiscopes

Vet-Alarm Respiratory Monitor **JorVet**

This respiratory monitor is a simple yet reliable indicator of apnea. The sensor is placed in the breath pathway and detects each breath. If a breath does not take place in a selected time interval an alarm will sound. A flashing liquid crystal screen shows the last time a breath was detected. 2" x 5" x 5".

- Small, 1 1/2 lbs.
- Rechargeable battery
- Mounting bracket

BUY NOW

JOR166M 2" x 5" x 5" \$495.00/ea



Vet-Alarm Respiratory Monitor Accessories

- JOR166MD1A Sensor Wire with Connector \$48.00/ea
- JOR166MD2 Rechargeable battery \$36.00/ea
- JOR166MD3 AC adaptor recharger \$24.00/ea



BUY NOW

Jorvet Breathe Safe Respiration Monitor

This tiny—smaller than a cigarette pack—monitor makes a great apnea alert monitor. The small microprocessor beeps with every breath with a very high sensitivity.

- Easy to use: just connect between endotracheal tube and anesthesia circuit
- No adjustments: a sophisticated algorithm recognizes and indicates every breath with a beep, working from a 1 lb. kitten to a 200 lb. St. Bernard.
- Apnea alert: a distinctive alert sounds if patient fails to breathe for 45 seconds
- Auto shut-off
- A high density long-life lithium battery provides years of service
- One-year warranty

JOR166RM 1/2"W x 2 1/4"L x 1 1/2"D. 3oz \$205.00/ea

JorVet

BUY NOW



Check Out Our Anesthesia Section for a full selection of products



Canine Vaginoscope **BUY NOW**

Can also be used as a proctoscope.

- JOR1140M Medium 6" x 5/8" \$14.40/ea
- JOR1140S Small 6" x 1/2" \$14.40/ea
- JOR1140L Large 6" x 3/4" \$14.40/ea

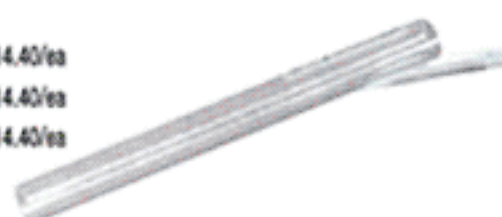

JorVet

Large Animal Vaginoscope **BUY NOW**

Equine and heifers. Autoclavable.

- JOR1144H 1 1/2" I.D. x 18" \$20.25/ea
- JOR1144I 2" I.D. x 18" \$27.00/ea

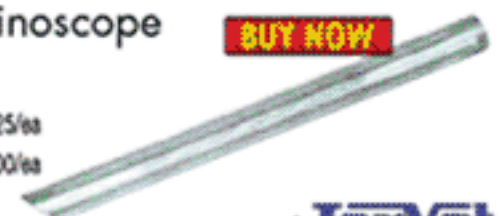

JorVet

Llama Vaginoscope **BUY NOW**

- JOR1144L 1" I.D. x 12" \$18.00/ea



BUY NOW

Vaginal Speculum **BUY NOW**

Exterior surface is silicon-coated and one end is rolled smooth for ease of insertion. The interior surface is lined with aluminum foil for optimum light reflection. Individually wrapped. Disposable

- JOR271 Sterile, 11.4" dia. 18"L. 50/pk \$110.00/pk **JorVet**

Bovine Heavy-Duty Laryngoscope **BUY NOW**

Withstands chewing. Autoclavable.

- JOR1144J 1 1/2" x 18" \$22.50/ea

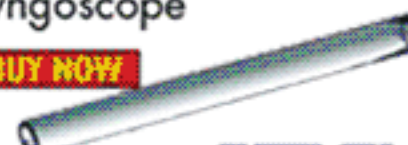

JorVet

Canine Gas troscope **BUY NOW**

Excellent for visualizing the upper GI. Large. Not autoclavable.

- JOR1144NL Large 18" x 5/8" \$14.40/ea
- JOR1144NS Small 18" x 1/2" \$14.40/ea

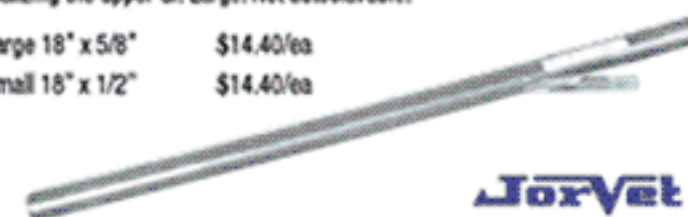

JorVet

Light Conducting Rod with Clip

- JOR1144KM (Cliplight shown attached to scope) \$7.50/ea

BUY NOW

Not autoclavable.



JorVet

Diagnostic Supplies

Diagnostic Test, Blood Filtration & Time Devices



Petchek Heartworm PF Antigen Test

RXPETCHEK-D 192 tests/box

\$500⁰⁰/bx

Schirmer Tear Test

RXSCHIRMERS0 50 strips per box

\$58⁸⁹/bx

Witness Heartworm Antigen Test

RXWITHW-25 25 tests/box

\$120⁰⁰/bx



Witness FeLV Test Kit

RXWITFELV-10 10 tests/kit

\$126⁰⁰/pk

Witness Parvo Test

RXWITPARVO-10 10 tests/box

\$235⁰⁰/bx

Dermatophyte Test Medium

RXDTM-CULTURE 10 cultures/box

\$1799/bx

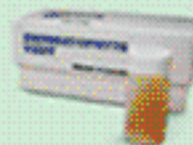

No returns on pharmaceuticals • Prices subject to change without notice.
Shipping charges for refrigerated items are a flat charge based on zone.
Customer accepts full responsibility for condition of products upon receipt.

Idexx Snap Test



RXCOMBO-150 FeLV Ag/FIV Ab Combo, 15 tests/box \$447.00/bx
RXCOMBO-300 FeLV Ag/FIV Ab Combo, 30 tests/box \$699.00/bx



RXGIAR-150 Giardia, 15 tests/box

\$199⁰⁰/bx

RXPARVO-50 Parvo Antigen, 5 tests/box

\$103⁰⁰/bx

RXFELV-150 FELV Antigen Test, 15 tests/box

\$269.00/bx

RXFELV-300 FELV Antigen Test, 30 tests/box

\$490.00/bx

RXHEART-150 Heartworm Antigen, 15 tests/box

\$199.00/bx

RXHEART-300 Heartworm Antigen, 30 tests/box

\$321.75/bx

RXDEX-30X-30 30X for heartworm, ehrlichia, Lyme, 30 tests/box

\$525⁰⁰/bx

Idexx Test

RXDEXALP Alkaline Phosphatase 25 tests/box \$130.00/bx
RXDEXAMYL Amylase 25 tests/box \$130.00/bx
RXDEXBUN BUN 25 tests/box \$148.00/bx
RXDEXCRE Creatinine 25 tests/box \$148.00/bx
RXDEXGHP General Health Profile (GHP), 12 chem/profile, 2 profiles/box \$73.00/bx
RXDEXLIP Lipase 25 tests/box \$130.00/bx
RXDEXPAP Pre-Anesthetic Profile (PAP), 6 chem/panel, 4 panels/box \$100.00/bx
RXDEXALT ALT 25 tests/box \$130.00/bx

Jorvet Surgicutt Bleeding Time Devices

A simple automatic incision making handheld device for determining bleeding time i.e. buccal mucosal bleeding time. White color. 1 mm depth blade for large dogs. Single use product.



JORS22S Adult \$6.60/ea
JORS22J 1" x 1" x 3/8", Surgicutt Junior \$6.60/ea
JORS22P Surgicutt blotting paper \$18.75/ea

Jorvet



Handy Tech Pet Parking System

Jorvet

The new "hands free" secure pet parking system secures a dog safely in one quick and simple move. It is useful for both clients and clinic staff. The system can be mounted just about anywhere. Useful near or at the reception desk, in exam or treatment rooms. Spiral shaped with no sharp hooks. Epoxy-coated stainless steel. Two mounting screws with anchors provided. 4/box.

BUY NOW

JOR762B Blue, 2 3/4"W x 2 1/2"H x 2 1/2"D \$12.90/pk
JOR762G Gray, 2 3/4"W x 2 1/2"H x 2 1/2"D \$12.90/pk
JOR762R Red, 2 3/4"W x 2 1/2"H x 2 1/2"D \$12.90/pk
JOR762Y Yellow, 2 3/4"W x 2 1/2"H x 2 1/2"D \$12.90/pk
JOR762 Set of all 4 colors, 2 3/4"W x 2 1/2"H x 2 1/2"D \$18.00/pk



Hemo Nate Blood Filtration System

Removes small volumes of particulate debris through an 18 micron stainless steel filter which allows viable blood product to pass through with ease. Especially useful with "syringe" method of transfusion used in feline medicine.

JORS22H Attaches to any male fitting. \$6.60/ea

Hemo Tap Filter Spike

This spike has a filter and can be used on any blood bag or transfer component bag. Used for adding blood compatible medications or syringe access.

JORS22T \$4.80/ea



BUY NOW



Thermometers

Digital Thermometer

Features a variety of high-tech innovations that make it ideal for veterinarians and technicians. It provides accurate temperatures at a fast pace. The portable lightweight high quality thermometer offers a wide temperature range: -40deg to 400deg F (-40deg to 150degC) with 0.10F resolution and a system accuracy of +0.210F or + 0.2% of readings.

- Operations status (F or C) is indicated on the display.
- Detachable fast-acting probe can be stored in a durable case when not in use.
- 3 1/2"L with reinforced connection. Final temperature readout within 60 seconds.
- Warranty: 1 year on unit, 90 days on probe.

JOR285B	Battery Unit with probe	\$282.00/ea
JOR285EC	Extension cord, 10 ft.	\$47.00/ea
JOR285P	Probe only	\$79.00/ea

Quick Read Handheld Digital Thermometer



This thermometer gives a quick reading with an audible beep. The special design is a very ergonomic hand-held angle that works well for all animals large and small. Uses two AAA batteries (included). You can select either Fahrenheit or Celsius. Automatically shuts off if not in use.

JOR188 Reading in 10-60 seconds \$30.00/ea



Audible Digital Thermometer



Features a variety of high-tech innovations that make it ideal for veterinarians and technicians. It provides accurate temperatures at a fast pace. Features: The portable lightweight high quality thermometer offers a wide temperature range of -40° to 400°F (-40° to 150°C) with 0.1°F resolution and a system of accuracy of +0.21°F or +0.2% of readings. Operations status (F or C) is indicated on the display. The detachable fast-acting probe can be stored in a durable case when not in use. 3 1/2"L with reinforced connection. Final temperature readout within 60 seconds.

JOR134A 5"L. Available with or without a case. \$6.00/ea

Probe Covers

NOTE: Not recommended for use in large animals.

JOR134AC Sterile, 100 pk. \$10.50/ea



Jorvet Plastic Thermometer Case

Heavyduty plastic, will hold large animal thermometer (sold separately) has clip for shirt/jacket pockets.

JOR187F 5"L \$1.20/ea



Jorvet Digital Thermometer Flexible Tip

More patient-friendly than the standard rigid thermometer. Reads fahrenheit scale and has an audible beep when ready.

JOR134F Battery operated \$6.60/ea



Fecal Loop

BUY NOW



Inexpensive plastic loop with slotted ends for quick and easy fecal samples. Reusable. This can easily be inserted into the rectum and a small amount of fecal material trapped in the loop. Can be cleaned, disinfected, and used repeatedly. Two convenient sizes available.

JOR147	Standard size. 9" x 3/8".	\$2.75/ea
JOR147P	Puppy & Kitten size. 4 3/4" x 1/4".	\$2.75/ea

Anti Kick Device

BUY NOW

Bron screw down model for use on Achilles Tendon.

JOR66 Bovine Use \$78.00/ea



Anti-kick Bar

BUY NOW

JOR66B Bovine Use \$24.00/ea

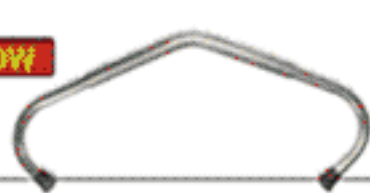

Aspir-Gun

BUY NOW

12cc. The Aspir-gun is combined with a 12cc syringe for precise fine needle aspiration biopsy. It can be used on any nodule that can be palpated or visualized with X-ray or ultrasound. It is especially useful for superficial lumps, allowing one hand to remain free to immobilize the lesion. Autoclavable.

JOR645 6" L \$70.00/ea



Michele Trephine

BUY NOW

Perfect instrument for a bone biopsy or drilling a small hole into the sinus. 6mm head. German-made. Stainless steel. Autoclavable.

JOR229 German, Stainless steel, 7 1/2". \$113.00



Jorvet Foreign Body Retriever

For small animals. This instrument can be inserted into gastroscope to grasp any lodged foreign body.

JOR103 24" \$27.00

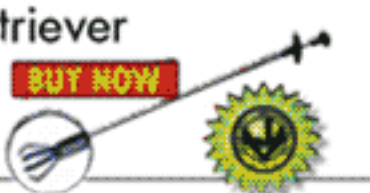

Anesthesia Products

Anesthesia Units



Mobile Anesthesia Unit

Small Animal Lexus Anesthesia System. Performance for a high standard of care with economy of initial investment. Precise machined fittings for an airtight connection. Powder coat finish is attractive and easy to clean. Protected, enclosed flowmeter with 200cc to 4 lpm setting. Integrated O2 flush valve set at 15 lpm. Soda lime canister is protected by its location under block. Smaller size, 970cc, versus standard 1300cc. Also quick turn knob for each change of exhausted soda lime. Pop-off valve attaches to a standard scavenger unit. Manometer pressure gauge for proper bagging of animal.

- Includes two anesthesia circuits, one universal "F" circuit and one non-breathing circuit.
- Available in mobile and table top models.
- Will accept most vaporizers.
- Available with Tech III or Tech IV vaporizer.

Item#	Details	Price
JOR559	Mobile Unit without Vaporizer	\$1,998.00/ea
JOR559A	Mobile Unit With Vaporizer	\$2,875.00/ea
JOR559B	with Refurbished Drager Isoflurane Vaporizer	\$3,040.00/ea
JOR559Z	Anesthesia Machine w/ Tech V Vaporizer	\$3,050.00/ea

Wall Mount Anesthesia Units

JOR559W	w/o Vaporizer	\$1,560.00/ea
JOR559WB	with Drager Vaporizer	\$2,410.00/ea
JOR559WC	w/Tech V Vaporizer	\$2,380.00/ea
JOR559WSA	w/Tech III Style	\$2,445.00/ea

BUY NOW

Rodent Anesthesia Machine

JOR559R	w/Isoflurane Vaporizer, without CO2 absorber	\$1,995.00/ea
JOR559RW	Wall Mount No Vaporizer w/o CO2	\$1,300.00/ea

BUY NOW

Wall Mount Anesthesia Machine w/Arm

JOR559WS	w/Arm & No vaporizer	\$1,720.00/ea
JOR559WSC	w/Arm & Tech V vaporizer	\$2,800.00/ea
JOR559WSB	w/Arm & Refurbished Drager Vaporizer	\$2,680.00/ea

BUY NOW

Retractable Lift Assisted Anesthesia Machine

JOR559Y	w/o Vaporizer	\$2,636.00/ea
JOR559X	w/ Tech IV Vaporizer	\$3,260.00/ea
JOR559X3	w/Tech III Vaporizer	\$3,990.00/ea

BUY NOW

Table Top Anesthesia Unit

JOR559T	w/o Table Top Unit	\$1,542.00/ea
JOR559BT	w/o Table Top Unit without vaporizer	\$2,500.00/ea
JOR559TC	w/low Tech V vaporizer	\$2,650.00/ea
JOR559TV	w/o Vaporizer	\$1,542.00/ea

Accessories

Encased Flowmeter .2-4 LPM

JOR559D6 \$239.00/ea

Pop-off Valve

JOR55907 \$162.00/ea

Table top base only

JOR559TB \$330.00/ea

Manometer

JOR559D8 \$49.00/ea

Storage Shelf for Anesthesia Machine

JOR559S \$108.00/ea

Isoflurane Vaporizer

Brand new vaporizers in familiar Tech III style. Features precision delivery and temperature compensation. Standard funnel fill, and can be mounted onto any brand anesthesia machine. Vaporizers shipped directly from manufacturer. Shipping charges billed at actual freight. THIS IS ISOFLURANE!!!

Refurbished. The standard vaporizer that has been a work horse of the veterinary field for many years. Vaporizers shipped directly from manufacturer. Shipping charges billed at actual freight.

- Temperature compensation.
- Precision delivery.
- One year warranty.

JOR562A	Isoflurane Tech III	\$1,500.00/ea
JOR561	Isoflurane Re-Furbished	\$1,050.00/ea



BUY NOW

JorVet

Tech Vaporizer

Refurbished. For many years the veterinary industry's most popular vaporizer was the Tech III. The Tech IV is the next generation of vaporizer and offers many improvements. Vaporizers shipped directly from manufacturer. Shipping charges billed at actual freight. Can be tipped over and still function accurately. Increased accuracy to lower flow rates. Fits most standard machines. One year warranty.

- Temperature compensated.
- Precision delivery.

BUY NOW

JOR561B	Tech III Refurbished	\$1,110.00/ea
JOR561A	Tech IV Refurbished	\$930.00/ea



Tech IV

Tech III



Tech III Isoflurane Vaporizer 250cc

JOR562C \$1,700.00/ea

BUY NOW

Anesthesia Products

Vaporizers & Supplies

Sevoflurane Vaporizer

Brand new vaporizers in familiar Tech III style. Features precision delivery and temperature compensation. Standard funnel fill, and can be mounted onto any brand anesthesia machine. Vaporizers shipped directly from manufacturer. Shipping charges billed at actual freight. THIS IS SEVOFLURANE!!!

BUY NOW

Item#	Details	Price
JOR562S	Sevoflurane Tech III	\$1,820.00/ea

Sevoflurane Anti-Spill Pour Spout

This handy adapter screws onto gas agent bottle top and the other end fits snugly into the filling funnel on the gas vaporizer. It makes vaporizer refilling spill free. Color coded for agent type.

JOR562Y	\$51.00/ea	BUY NOW
---------	------------	----------------

Halothane Anti-Spill Pour Spout

JOR562Z	45cm X 35cm	\$51.00/ea
---------	-------------	------------

Drager Isoflurane Vaporizer

North American Drager refurbished Isoflurane vaporizer. These temperature compensated precision vaporizers have enjoyed wide-spread use in human hospitals. JorVet is offering fully refurbished units that fit standard veterinary anesthesia machines. Three-year warranty included.

BUY NOW

JOR562D	Three-year warranty included.	\$990.00/ea
---------	-------------------------------	-------------

Drager Sevoflurane Vaporizer

JOR562E	Refurbished	\$1,100.00/ea
---------	-------------	---------------

BUY NOW

Sevoflurane Tech IV Refurbished Vaporizer

JOR562B	\$1,425.00/ea
---------	---------------

Tech V Isoflurane Refurbished Vaporizer

Tec V Isoflurane Vaporizer. 250cc. Refurbished the newer model of the Tec Ohmeda series

JOR561X	\$930.00/ea
---------	-------------



End Cap for vaporizer Male - Female

JOR561VC	\$56.00	BUY NOW
----------	---------	----------------

End Cap for vaporizer Male - Female

JOR561VCM	\$40.00/ea	BUY NOW
-----------	------------	----------------

Large Humidifier with Oxygen Dilutor

This device works by oxygen bubbling through a diffuser in a fluid. The humidifier has a dilutor to adjust the oxygen going through the diffuser.

JOR948H	\$12.00/ea	BUY NOW
---------	------------	----------------

Thermoblocker Recovery Bag

Same heat reflective core material. The recovery bag works like a sleeping bag with two sides stitched together and integral Velcro strips on the other two sides.

JOR955A	70cm x 45cm	\$36.00/ea
JOR955B	45cm x 35cm	\$21.00/ea

Oxygen Sensor Only

JOR948S	\$186.00/ea	BUY NOW
---------	-------------	----------------

JorVet



Tracheotomy Tube

Pape's model. Nickel -plated brass.

JOR144A	Papes Model 18mm I.D. 22mm O.D.	\$36.00/ea
JOR144B	Papes Model 22mm I.D. 28mm O.D.	\$36.00/ea

Soda Lime

JorVet soda lime is a high-grade granular product that effectively absorbs carbon dioxide that is produced as an anesthesia by-product. It is a mixture of calcium hydroxide Ca(OH)₂ also known as lime plus a smaller amount of sodium hydroxide NaOH. Upon exposure to carbon dioxide CO₂, the calcium hydroxide converts to calcium carbonate CaCO₃. This prevents CO₂ buildup in a re-breathing circuit. The sodium hydroxide acts as a catalyst in the process. No potassium hydroxide (KOH) is present in JorVet soda lime; this helps to avoid the formation of toxic compounds such as Compound A and carbon monoxide. JorVet soda lime has a pH color change indicator that changes from white to violet when the soda lime needs to be changed. It will eventually return to its original color if not changed. Therefore, a good rule of thumb is to replace the soda lime every time the vaporizer is filled.

- Minimal dust
- No KOH-minimizing chance of anesthetic reactions that produce toxins
- Irregular particle size-creates more surface area
- Saturation indicator built-in changes from white to violet
- Particle size 4-8 USP Mesh (2.5mm-5mm)

BUY NOW

JOR553	3 lb. bag	\$7.60/ea
--------	-----------	-----------

Soda-Lime Canister

Pre filled canister is preferred by many clinics. Comparable with other brands of canister - identical in size and weight.

JOR559D4	920 grams	\$250.00/ea
----------	-----------	-------------

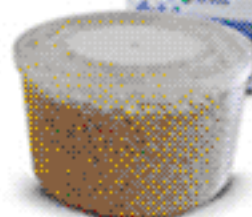

Jorvet Soda Lime Pre-Filled Canister

JOR533C	Soda lime pre-filled canisterAudio-visual alarm	\$9.45/ea
JOR553C	Prefilled, 920 gramsAudio-visual alarm	\$9.60/ea

Non-Rebreather Mask

Latex-free and available in a variety of styles, each mask is designed for patient comfort with a soft, anatomical form. Barbed fittings help prevent patient from disconnecting the mask while the elastic straps and adjustable nose clips secure it for a better fit. Pediatric, Non-Rebreather Mask, Reservoir Bag, Safety Vent, Check Valve, 7' (2.2m) tubing

HCS4642	Non-rebreathing Mask, Reservoir Bag, Safety Vent, Check Valve, 7' (2.2m) tubing	\$149.00/cs
---------	---	-------------



Jorvet Audio-visual Alarm

This alarm both emits an audible alarm and a blinking signal when the oxygen pressure drops too low. Can be away from tank.

JOR533AV	Audio-visual alarm	\$760.00/ea
JOR533EM	Dual tank manifold with switch port	\$879.00/ea
JOR533PS	Single setting pressure switch	\$450.00/ea



13822 WEST BOULTON BLVD. METTAWA, IL 60045

WWW.SHOPMEDVET.COM

Phone 800-544-7521

299

Fax 800-204-2177

Anesthesia Products

Oxy Cage & Buster Cage

Jorvet Vapor Wand **BUY NOW**

Vapor Wand. Veterinarians often treat ferocious or vicious animals such as aggressive cats and dogs, small zoo animals, wildlife, primates, reptiles, and other exotic species. For proper examination or surgery, these animals need to be anesthetized. Older methods such as pole syringes and darts are high risk to both the animal and the veterinarian. Anesthesia chambers have size limitations, and transferring the patient safely into chambers can be risky. The development of anesthetic agents such as isoflurane can make induction faster, quieter, and safer.

David S. Hodgson DVM, DACVA at Kansas State

University Veterinary Teaching Hospital, developed the innovative Vapor Wand to deliver anesthetic vapors into enclosed cages and pet carriers. The Vapor Wand is a small round stainless steel vented probe with a cotton

wick. It is attached to a 400ml air pump. When a pre-measured dose of liquid isoflurane is added to the wick, and the air pump is cycled, the liquid isoflurane is vaporized. Any animal may be quickly anesthetized by use of the Vapor Wand inserted into the sealed environment. The example shown is a transport kennel placed into a plastic bag. The Vapor Wand is inserted into the kennel and the air pump is cycled. The round viewing window allows for observation of the animal during induction of anesthesia. When induction is complete, the bag is opened. The animal may be maintained via mask or other anesthetic techniques.

Vapor Wand Kit. Includes:

- Vapor wand 32 1/2" L x 3/4" D
- 400ml reusable syringe
- Small viewing port with window
- Laminated dosage calibration chart
- Instructional CD-ROM

JOR990 \$180.00/ea

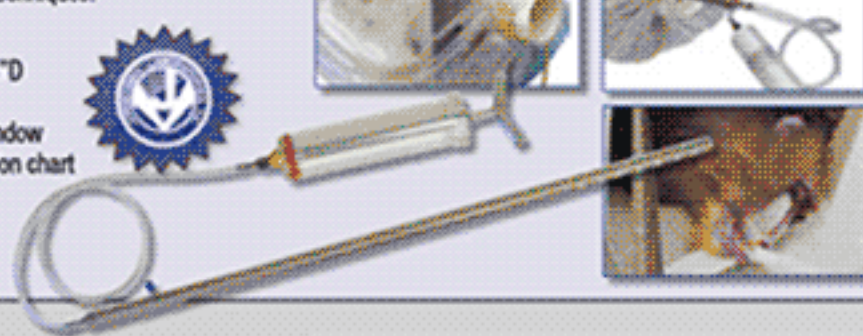
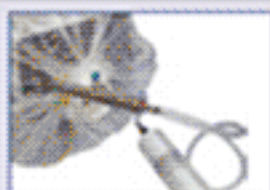
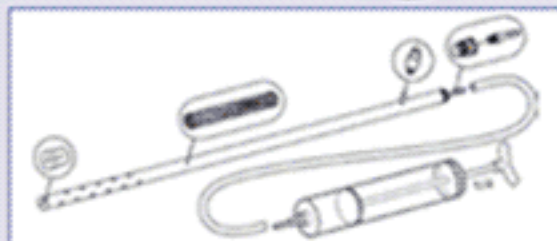
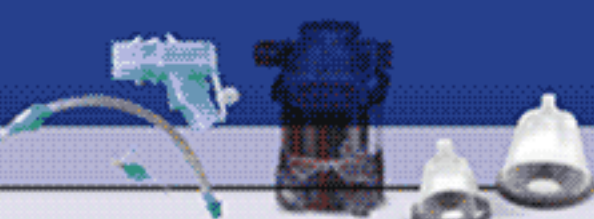

Jorvet Oxy Cage **BUY NOW**

This portable cage serves a variety of critical care needs. (Product may vary slightly from picture.) Includes:

- Oxy cage
- Two 9cc nebulizers (JOR949n)
- Humidifier canister (JOR653)
- Four lengths oxygen tubing, 7' L (JOR655)
- Christmas tree connector (JORS95c)
- Two 90° elbow connectors

The Oxy Cage is a specially modified lightweight transport kennel. Side windows are clear plexiglass. Special vents can be opened for ventilation. The door grill is backed with a removable clear plexiglass. A special lining in the door frame provides a tight seal when the door is closed. The floor has a raised comfortable floor grill (1/2 H). Both temperature

and humidity information are provided via a digital monitor. Special connectors allow attachment of oxygen tubing, humidifiers, and medicated nebulizers. Any oxygen source with a flowmeter can be used (i.e., oxygen tank or oxygen concentrator).

JOR947	Small, Complete	\$424.00/ea
JOR947A	Medium, Complete	\$570.00/ea
JOR947B	Large, Complete	\$670.00/ea
JOR947C	X-large, Complete	\$750.00/ea



Buster ICU Cage

The Buster ICU cage offers the most affordable intensive care unit available. It can simply fold up into a small nylon bag for storage after use.

- Controlled oxygen therapy
- Can double as an anesthesia chamber
- Collapsible for daily storage and set up anywhere i.e. standard stainless cage Specifications on design
- PVC lined for easy cleaning
- Clear vinyl window covers for visualization
- Either warmth or cooling can be provided with reusable gel packs

Accessories include: oxygen accessory kit (JOR1057g)

- 6 color coded venturi oxygen delivery nozzles
- Small nebulizer
- Connecting T-piece
- Oxygen tubing 7ft (2.1m)

Oxygen Accessory Kit

6 color coded venturi oxygen delivery nozzles

- Small nebulizer
- Connecting T-piece
- Oxygen tubing 7ft (2.1m)

BUY NOW

JOR1057O Oxygen Accessory Kit (JOR1057g) \$48.00/ea

Buster Comfort Mattress

- Fits inside Buster ICU cage for soft patient comfort
- Waterproof black nylon cover with zipper
- Can be scrubbed clean then drip dry in minutes
- Withstands most disinfectants
- Includes gel pack that can provide heat (microwave) or cool (refrigerator)
- Gel packs are non-toxic if accidentally consumed
- Buster kennel mattress available separately with gel packs.



BUY NOW



JOR1057	Small, 18" x 14" x 14"	\$226.00/ea
JOR1057A	Medium, 24" x 18" x 18"	\$268.00/ea
JOR1057B	Large, 44" x 26" x 26"	\$472.00/ea

JOR1058	Small, 18" x 12" x 3.2"	\$57.00/ea
JOR1058A	Medium, 24" x 18" x 3.2"	\$89.00/ea
JOR1058C	Large, 26" x 24" x 3"	\$176.00/ea

Therma-Kool

JOR1057X 10" x 15" \$9.00/ea

13822 WEST BOULTON BLVD. METTAWA, IL 60045

WWW.SHOPMEDVET.COM

Phone 800-544-7521

300

Fax 800-204-2177

Integra Oxygen Concentrator

BUY NOW

Oxygen concentrators separate air into primary components such as oxygen and provide the lowest cost mechanism to do so. The Regalia offers an ideal and innovative system for supplying oxygen to anesthesia machines and for emergency oxygen needs. This concentrator will extract medical grade O₂ directly from the air and deliver it to a desired location. The digital flow rate meter delivers 1-7 lpm or 1-10 lpm of continuous O₂. If the flow meter rate is set at 1 lpm it will deliver a 95 percent O₂ concentration, 5 lpm will deliver 90 percent concentration. Made specifically for the veterinary market.

Features:

- Reliable O₂ production with constant delivery pressure
- Eliminates need for O₂ tank
- Compact, lightweight, yet rugged environmentally tolerant design
- Quiet operation
- Easy-to-read digital flow meter
- Control knobs are large and easily accessible
- Self cleaning, minimal maintenance
- Low operating cost, 5 watt power consumption
- 14.7"W x 26"H x 10.1"D. 54 lbs. (24 Kg)

Three year warranty Performance:

- Flow rate: variable 1/2-7 lpm (JOR744) or 1/2-10 lpm (JOR744a)
- O₂ pressure 5 psi (37.9 Kpa) minimum
- O₂ Concentration 95-92 percent at 0-3 lpm 95-90 percent at 3-5 lpm
- Designed for anesthesia machines, 2 maximum.

JOR744A 0-10 lpm flow rate. 16"W x 20"H x 8 1/2"D **\$2,150.00/ea**



Oxygen Booster 90PSI with Relief Valve

The use of an oxygen concentrator, delivering oxygen at 5-7 PSI, may be combined with an oxygen booster. In cases where central oxygen or long oxygen hose lines are needed the oxygen booster should be used to increase oxygen pressure. Free standing metal cabinet uses 110V AC power via a 3-pronged plug. (not pictured)

JOR744C 16"W x 20"H x 8 1/2"D. 16"W x 20"H x 8 1/2"D **\$3,250.00/ea**

JOR744B 16"W x 20"H x 8 1/2"D. 36 lbs. 16"W x 20"H x 8 1/2"D **\$2,106.00/ea**

Pop-Off Valve Restrictor

BUY NOW

The restrictor is placed on the pop-off valve exhaust port and the scavenge tubing is attached to the other end. The button on the device top is depressed to close the exhaust, thus allowing the bagging of the animal. The restrictor allows the anesthetist to leave the pop-off valve open, but the animal still may be bagged when necessary. This prevents the chance that the pop-off valve may be left accidentally closed, a situation which causes high pressure within the system, and can lead to respiratory damage and pneumothorax. Made from Delran, a sturdy, durable material.



JOR559D3 \$57.00/ea **Jorvet**

Repair kit for JOR744 & JOR744A

BUY NOW

Kit to rebuild compressor for Integra concentrators.

JOR744RK \$110.00/ea



Jorvet Booster Repair Kit



JOR744CRK \$98.00/ea

BUY NOW

Jorvet Extension Piece for 2nd Vaporizer

JOR55902 \$39.00/ea

BUY NOW

Jorvet Hose Assembly Kit for JOR744C

JOR744HK \$48.00/ea

BUY NOW

Isoflurane Inhalant Anesthetic

A non-flammable, non-explosive inhalation anesthetic.

Starting at:

\$9.99

RXIS0-100 100ml \$9.99
RXIS0-250 250ml \$22.50



BUY NOW

Prices subject to change. Call before ordering.

YOUR ONE STOP SHOP FOR VET/MED SUPPLIES



Jor-Vet Fresh Breath Canister Installation Kit

Breath Fresh Anesthesia Gas Filter. Activated charcoal canisters remove up to 50g of waste anesthetic gas. They attach to standard 19mm scavenger hose.

Features:

- Inexpensive refills available
- Lasts 12-15 hours of anesthesia
- Simple to use: connect and ready to go
- Mounts right on anesthesia machine pole

Mounting Kit Includes:

- Mounting Bracket for attachment to anesthesia pole
- Breath Fresh Canister
- 19mm Tubing 40'L

JOR304K	Mounting Kit Complete	\$22.20/ea
JOR304	Canister Only	\$12.75/ea
JOR304K	Mounting Kit Complete	\$22.20/ea

Breath Fresh Refill Pack, 200 gram

JOR304R	DIMENSIONS: H 15 CM (6") WEIGHT OF ACTIVE COMPONENTS: 200g DIAMETER: 7.5CM (3") CONNECTOR: 19MM O.D.	\$5.70/ea
---------	--	-----------

BUY NOW



BUY NOW

Anesthesia Chamber Jor-Vet

The Lexan anesthesia chamber provides a simple method of induction. Chamber induction reduces physical restraint which minimizes stress and reduces the chance of injury to the operator and animal. The divider system allows for up to four different chamber sizes within one unit: 18" x 9" x 9" / 12" x 9" x 9" / 6" x 9" x 9" x 9" Unit weighs 10 lbs.

JOR265	18" x 9" x 9", 10 Lbs	\$242.00/ea
--------	-----------------------	-------------

Jor-Vet



BUY NOW

Anesthesia Breathing Tube

Corrugated black rubber conductive breathing tubes with natural rubber 22mm cuff inserts.

JOR249H	36'L	\$42.00/ea
JOR249J	40'L	\$48.50/ea

Anesthesia Scavenging Hose

Anesthesia Scavenging Hose 19mm

JOR248D	19mm, 10ft Roll	\$18.90/ea
JOR248T	22mm, 10ft Roll	\$7.20/ea



BUY NOW

Disposable Anesthesia Mask

A crystal clear plastic material with inflation/deflation valve for better patient fitting. Inexpensive. 15mm OD fitting. Five different sizes. This one-way valve inflates with any standard syringe.

JOR298DA	2" i.d. widest area x 3 1/2" vertical i.d.	\$9.00/ea
JOR298DB	2" i.d. widest area x 2 1/2" vertical i.d.	\$9.00/ea
JOR298DC	1 3/4" i.d. widest area x 2 1/4" vertical i.d.	\$9.30/ea
JOR298DD	1" i.d. widest area x 1 3/4" vertical i.d.	\$9.75/ea
JOR298DE	1 1/4" i.d. widest area x 1 1/4" vertical i.d.	\$9.75/ea
JOR298DS	Set Of 5 Sizes	\$36.00/ea



Jor-Vet

Halls Anesthesia Mask

Soft, malleable black rubber. This mask will conform to the animal's muzzle shape, allowing a custom fit. Standard 15mm connection to anesthesia circuit.

JOR298HA	Small	\$132.00/ea
JOR298HB	Medium	\$126.00/ea
JOR298HC	Large	\$129.00/ea

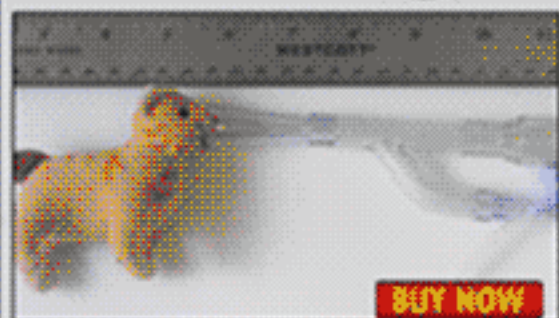

BUY NOW

Exotic/Small Animal Anesthesia Mask and Non-Rebreathing Circuit

These especially small masks were specifically designed for use on small exotics such as pocket pets and birds. The small circuit hooks up the same way as a nonrebreathing circuit does to an anesthesia machine.

The masks fit tight around the nose and mouth. Soft conforming cone can be trimmed to custom fit animal's nose. The oxygen/gas tube position can be adjusted inside mask. Also circuit can be taped to the table to help keep it positioned on the animal's snose or muzzle.

JOR297AN	9 mm Opening, 10" tubing	\$29.00/ea
JOR297BN	12.5mm Opening, 10" tubing	\$29.00/ea
JOR297CN	14.0mm Opening, 10" tubing	\$29.00/ea



BUY NOW

Mask One Way Valve

Stop anesthesia gas. This handy valve allows the fresh gas to be shut off when not needed. Fits inline between mask or endotracheal tube and anesthesia circuit. Especially useful when using anesthesia mask.

JOR298MV	Valve Only	\$59.00/ea
----------	------------	------------

BUY NOW



Jorvet Anesthesia Mask

Anesthesia Masks with low dead space. Clear plexiglass masks with black rubber diaphragm.

JOR298C	Canine 5" Opening	\$28.50/ea
JOR298CD1	Diaphragm Only (Canine)	\$13.95/ea
JOR298F	Feline 3.5" Opening	\$27.00/ea
JOR298FD1	Diaphragm Only (Feline)	\$13.65/ea

Anesthesia Products

Breathing Bags & Oxygen Systems

BUY NOW



Reusable Black Rubber Breathing Bag **JorVet**

Our oval/flat breathing bags are manufactured from black conductive natural rubber. High quality and long lasting.

JOR249R	3 Liter 22mm Neck Insert	\$23.10/ea
JOR249R2	2 Liter 22mm Neck Insert	\$23.10/ea
JOR249S	3 Liter 22mm Neck Insert	\$27.00/ea
JOR249T	4 Liter 22mm Neck Insert	\$32.40/ea
JOR249V	5 Liter 22mm Neck Insert	\$36.00/ea
JOR249E	6 liter 22mm Neck Insert	\$38.00/ea

BUY NOW



Disposable-Breathing Bag **JorVet**

High quality latex breathing bags.

JOR249A	.5 Liter	\$6.00/ea
JOR249B	1 Liter	\$6.00/ea
JOR249B2	2 Liter	\$6.00/ea
JOR249C	3 Liter	\$6.00/ea
JOR248EAD1	1 Liter w/bleed valve	\$12.00/ea
JOR248ED1	.5 Liter w/bleed valve	\$13.50/ea

Jorvet Resuscitation Bag **BUY NOW**



For emergency artificial respiration. This device is ideal for administering either pure oxygen or room air to oxygen deprived patients. Special valve allows lung inflation upon compression of bag and passive exhalation of CO2 while fresh air refills the compressor bag. Two options feature your choice of hooking up to a central oxygen source or detaching and using room air. Attachment B will fit standard endotracheal tube or can be used with an airtight mask. Compression bag is heavy duty blue rubber.

JOR247A	3 Liter 22mm Neck Insert	\$51.00/bg
JOR247	3 Liter 22mm Neck Insert	\$58.65/ea



BUY NOW

Oxygen Cylinder/Tank Racks and Carts

Oxygen tanks are cumbersome and top-heavy items. The danger to clinic personnel from a dropped or toppled oxygen tank can be minimized with proper storage and handling. JorVet offers a number of oxygen tank racks and carts to safely handle the common "H" or "E" cylinders used in veterinary facilities. Various regulators and yokes are also available.

JOR686	12"W x 8"L x 39"-44"H. 71/2 lbs.	\$54.00/ea
JOR686A	9 1/2"D x 4 1/2"H. 7 1/2 lbs.	\$46.00/ea
JOR686B	5"W x 5"L x 16"H. 4 lbs.	\$90.00/ea
JOR687	14"W x 20"L x 49"H. 29 lbs.	\$260.00/ea
JOR687A	19"W x 12"L x 39"H. 30 lbs.	\$82.00/ea
JOR688	"E" Cylinder oxygen tank	\$95.00/ea
JOR686W	Wrench for "E" Tank	\$6.00/pk

Barbed Oxygen Connector

JOR686X	15mm id 2pk	\$6.00/pk
---------	-------------	-----------

Portable Oxygen Delivery System

The need for an emergency oxygen source can arise at any time. A clinic should be adequately prepared with the proper equipment that is made readily available and is stand-alone. Most clinics do not have central oxygen or may have just one oxygen tank that is dedicated to the anesthesia machine. The JorVet portable oxygen delivery system is everything you need just add the oxygen!

The system includes:

JorVet

- "E" oxygen tank with Yoke head - will hold up to 425 liters when full. (JOR686)
- Clic style regulator for "E" Yoke head, 0-15LPM dial. (JOR686R)
- Light weight wrench for opening/closing oxygen tank regulator. (JOR686W)
- Transport cart with 2 wheels that can go anywhere in the clinic. (JOR686)
- Clear oxygen tubing 7ft. Length (4pk) with a female DISS
- Fitting. (JOR655)
- Oxygen catheter 14ft delivers oxygen by nasal insertion or "blowby". (JOR656)
- Connectors: allow connection to standard anesthesia masks.

JOR686K \$210.00/ea

BUY NOW



NEW



Click Style Oxygen Regulator

JOR686R 0-15LPM \$84.00/ea

BUY NOW



NEW

SEE OUR PHARMACEUTICAL SECTION AND SAVE ON YOUR NEXT MED ORDER

13822 WEST BOULTON BLVD. METTAWA, IL 60045

WWW.SHOPMEDVET.COM

Phone 800-544-7521

303

Fax 800-204-2177

Anesthesia Products

Oxygen connectors & Gas Hose Assembly

Jorvet Oxygen Connectors and Gas Hose Assembly

A tremendous variety of options are available to design your own oxygen delivery system or add to an existing setup. A wide range of patterns of oxygen connectors is available with the DISS and Ohio style, quick/connect being the most popular.

Jorvet

NOTES about connectors:

DISS = Diameter Index Safety System. These fittings are designed to prevent errors and standardized connections. Only oxygen DISS male threads will match female oxygen DISS threads. Nitrous oxide and other gases each have their own thread patterns.

NPT = National Pipe Thread Sizing.

These relate to anesthesia machine fittings.

Gas Hose Assembly.

Jorvet

BUY NOW

Design your own custom oxygen or other gas line. FDA medical grade conductive hose that is kink resistant, lightweight, and reinforced with tough nylon braiding. Fittings are chrome-plated brass. Standard 1/4" I.D. • Color-coded to specific gas; **green = oxygen**

Oxygen Hose Assembly. (hose not included)

Jorvet

	One-End Connector		Opposite-End Connector	
JORS388	Female DISS x		female DISS	\$37.50/ea
JORS38E	Female Ohio x		male Ohio	\$73.00/ea
JORS38F	Female DISS x		Female Chemtron	\$93.00/ea
JORS38M	Female DISS x		Male Chemtron	\$45.00/ea
JORS38C40	Ferrule .500" ID			\$1.50/ea
JORS38C10	DISS female (hex) O2 Click style			\$6.90/ea

Oxygen Hose

Jorvet

JOR540##	Per Foot	\$2.40/ea
----------	----------	-----------

Combine connectors and amount of tubing needed for total pricing. JOR540 O2 hose specify length (feet).

Ordering procedure for oxygen hoses if not choosing one hose of those listed above.

1. Pick two ends of hose desired
2. Determine the number of oxygen hose in feet desired (JOR540)



BUY NOW

JORS33H



JORS33J



JORS35A

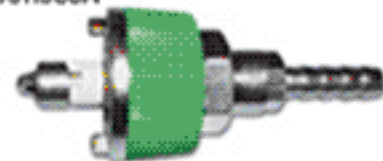

JORS36T



JORS36A

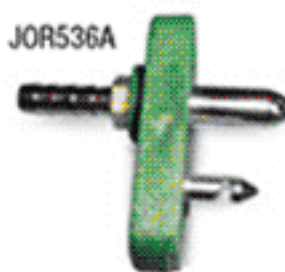

JORS36X

JORS36FA

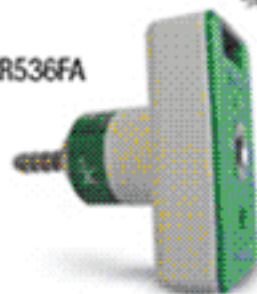

JORS36YB



JORS36Y

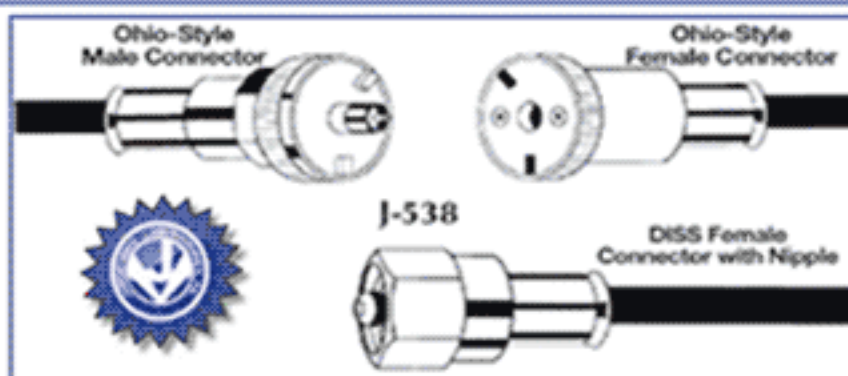

DISS fitting Barbed end

FEMALE DISS W/ HOSE, BARB AND FERRULE

JORS33G \$18.30/ea

DISS MALE FITTING W/BARBED END

JORS33H \$8.80/ea

DISS FEMALE HAND TIGHT TWIST OFF W/BARBED END

JORS33J \$15.00/ea

Ohio Quick Connect Barbed fitting

OHIO FEMALE & BARBED END

JORS35FA \$60.30/ea

OHIO MALE & BARBED END

JORS35A \$39.00/ea

BUY NOW

Chemtron Barb fitting

CHEMTRON FEMALE & BARBED END

JORS36FA \$75.00/ea

CHEMTRON MALE & BARBED END

JORS36A \$28.50/ea

Puritan-Bennett

PURITAN BENNETT FEMALE FITTING W/BARBED END

JORS36XA \$84.00/ea

PURITAN BENNETT MALE FITTING W/BARBED END

JORS36X \$20.00/ea

Schrader

SCHRADER FEMALE FITTING WITH BARBED END

JORS36YA \$77.00/ea

JORS36YB \$77.00/ea

SCHRADER MALE FITTING W/BARBED END

JORS36Y \$30.00/ea

SWIVEL MALE SCHRADER W/HOSE

JORS36VS \$25.00/ea

Oxyquip

OXYEQUIP MALE FITTING W/BARBED END

JORS36T \$27.00/ea

Jorvet



13822 WEST BOULTON BLVD. METTAWA, IL 60045

WWW.SHOPMEDVET.COM

Phone 800-544-7521

304

Fax 800-204-2177



Other Miscellaneous Connectors

Female DISS to male DISS w/check valve

Female DISS to male DISS check valve gives one-way flow

JOR533X \$19.10/ea **BUY NOW**

Male DISS to Female DISS w/reverse check valve

Male DISS to female DISS with reverse check valve gives one-way flow

JOR533Z \$21.00/ea **JORVET**

1/4" NPT female x 1/4" male check valve gives one-way flow

JOR538X \$46.00/ea **JORVET**

Male NPT to hose barb 1/4" NPT x 1/4" barb

JOR538MN \$5.10/ea

BUY NOW



DISS male check valve x 1/4 NPT

JOR539DMC \$18.00/ea **BUY NOW**

DISS male x 1/4 NPT

JOR539DM \$7.50/ea **BUY NOW**

JORVET Oxygen Fittings.

BUY NOW

These are double end connectors that allow connecting one pattern of connector to a DISS connector

Ohio Chemtron

JOR535FC	Male DISS to female Ohio connector	\$75.00/ea
JOR535FB	Female Ohio to DISS female	\$75.00/ea
JOR536FB	Female Chemtron to DISS male	\$78.00/ea
JOR536FC	Female Chemtron to DISS female	\$78.00/ea
JOR535B	Male Ohio to DISS male	\$31.50/ea
JOR536B	Male Chemtron to DISS male	\$28.50/ea
JOR535C	Male Ohio to DISS female	\$34.50/ea
JOR536BA	Male Chemtron to DISS female	\$30.00/ea

Miscellaneous Connectors

JOR533M	Male DISS/male DISS fitting	\$6.00/ea
JOR533F	Female DISS/female DISS fitting	\$15.00/ea
JOR533X	Female DISS to male DISS check valve gives one-way flow	\$19.10/ea
JOR533Z	Male DISS to female DISS with reverse check valve gives one-way flow	\$21.00/ea

Primary valve kit w/white insert

JOR537VK \$33.00/ea

Wye Adapters

Connects two machines or hoses to one outlet

JOR537D	Female DISS (hand tight) with two male DISS connectors with check valves.	\$75.00/ea
JOR537	One male Ohio with two female Ohio	\$210.00/ea
JOR537A	One male Ohio with two female DISS	\$105.00/ea
JOR537C	Chemtron male quick connect with two female Chemtron connects.	\$180.00/ea
JOR537E	Female Ohio with two female DISS hand tight	\$112.00/ea
JOR537CH	Chemtron female/w/DISS	\$200.00/ea

Nitrogen Manifold

Nitrogen manifold for H-tank	JOR533NH	\$228.00/ea
Nitrogen manifold w/ pressure switch port	JOR533NHP	\$795.00/ea
Nitrogen adapter DISS	JOR539DMN	\$29.20/ea
Nitrous DISS outlet	JOR537ND	\$92.50/ea

JOR536FA



JOR538X



JOR533M



JOR533F



JOR536FB



JOR536FC

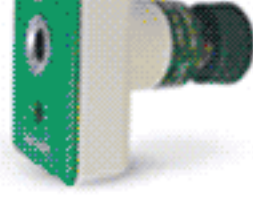

JOR539DM

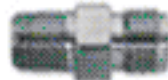

JOR539DMC



JOR537d



JOR537



JOR537C

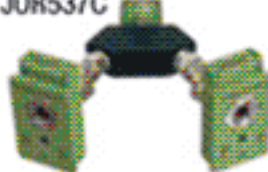

JOR535B



JOR536BA



JOR535FC

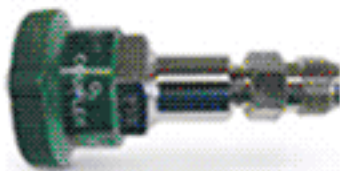

JOR537A



JOR535FB



JOR535C

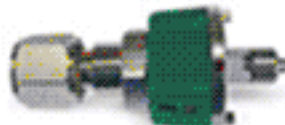

JOR536B



Anesthesia Products

Oxygen Hookups Regulators & Mounting Yoke

Wall Mount. Two types:

- Recessed: Fit flush with wall similar to electrical outlet
- Surface: Placed outside the wall

BUY NOW

JORS37Q	Ohio Female Quick Disconnect, Recessed.	\$108.00/ea
JORS37R	Male DISS, Recessed.	\$94.00/ea
JORS37S	Male DISS, Surface.	\$112.00/ea
JORS37T	Ohio Female Quick Disconnect, Surface.	\$121.00/ea
JORS37V	Male DISS Ceiling Outlet.	\$127.00/ea
JORS37W	Chemtron female, wall recessed, quick disconnect, similar to JORS37q, but Chemtron style, not Ohio-style.	\$114.00/ea



"Ganging" medical gas outlets has been done in human hospitals for many years. Now veterinarians are adding more gas and vacuum uses in their hospitals.

In addition to our oxygen outlets, you can order nitrous oxide, vacuum suction, and nitrogen outlets. They are ordered individually — this is the outcome when they are "ganged" together.

JORS37NSC	Nitrous ceiling outlet	\$92.50/ea
JORS37NSWC	Nitrous chemtron wall outlet	\$92.50/ea
JORS37AVD	Vacuum DISS outlet	\$105.00/ea
JORS37VAC	Chemtron vacuum outlet	\$87.00/ea
JORS37NW	Nitrogen recessed wall outlet	\$94.00/ea

BUY NOW

Hoses and connectors are available, call for more information.



NEW

Dual Tank Manifold **JorVet**

This dual tank manifold allows delivery of oxygen throughout the hospital or clinic via wall outlets or ceiling drops. The system consists of two pigtail hoses that connect to the 'H' tanks. Regulator and volume gauges are included. Then copper pipe (not provided) is plumbed to areas of the hospital requiring oxygen. The unit is wall mounted.

JORS33MH \$840.00/ea

BUY NOW



Vacuum Regulator

Vacuum/Suction Regulator for central vacuum/suction outlet with Chemtron connection. Use with JORS37vac shown above.

JORS30VR \$240.00/ea

BUY NOW



Tank Mounting Double Cylinder Yoke **BUY NOW**

Small Animal Lexus Anesthesia System. Performance for a high standard of care with economy of initial investment. Precise machined fittings for an airtight connection. Powder coat finish is attractive and easy to clean. Available in mobile stand or table top models. Will accept most precision vaporizers. Soda lime canister is protected by its location under block. Also quick turn knob for each change of exhausted soda lime. Includes two anesthesia circuits, universal F circuit and non-breathing circuit.

JORS60E Protected, enclosed flowmeter with 200cc 4 lpm setting integrated O2 flush valve set at 15 lpm Smaller size, 970cc versus standard 1300cc \$495.00/ea

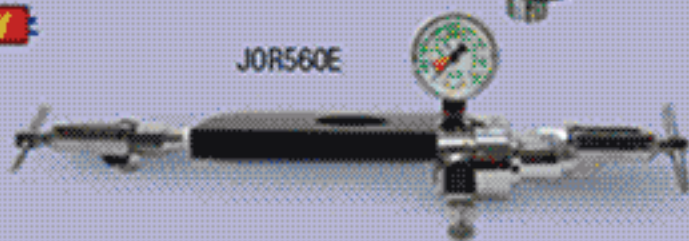

Single "E" tank holder

JORS60ES \$360.00/ea

BUY NOW

Single Step Oxygen Regulator for H-Type Nitrogen Cylinder

JORS33N \$254.00/ea

BUY NOW

JorVet

Anesthesia Products

Oxygen Regulators and flowmeters



Oxygen Regulars

Oxygen Regulator for "H" Cylinder



Pressure regulator for large H type oxygen cylinder. Male DISS outlet. Preset standard 50 psi outlet pressure 0-4000 PSI high pressure gauge indicates remaining cylinder contents

JOR533 \$140.00/ea **BUY NOW**

"H" Cylinder w/Flowmeter

Pressure Regulator for large H-type oxygen cylinder with addition of flowmeter 0-15 liters-per-minute. Also has pressure gauge indicating remaining cylinder contents.

JOR533A \$241.00/ea **BUY NOW**

"E" Cylinder



Pressure Regulator for E-type cylinder with pin indexed yoke and male DISS connector. Also has pressure gauge indicating remaining cylinder contents.

JOR533E \$238.00/ea **BUY NOW**

"E" Cylinder w/Flowmeter

Pressure Regulator for E-type cylinder with pin indexed yoke, attached flowmeter 0-15 liters-per-minute, and male DISS connector.

JOR533EF \$240.00/ea **BUY NOW**

Oxygen Flowmeters

Flowmeter 0-3 Liters/Minute

- Clearly marked with large numbers
- Designed for accuracy and durability
- Chrome body
- Standard DISS fittings



JOR534A \$120.00/ea **BUY NOW**

Flowmeter 0-5 Liters/Minute

- Clearly marked with large numbers
- Designed for accuracy and durability
- Chrome body
- Standard DISS fittings



JOR534B \$79.50/ea
JOR534BQ \$88.00/ea **BUY NOW**

Flowmeter 0-15 Liters/Minute

JOR534C \$81.00/ea **BUY NOW**
JOR534D \$182.00/ea **JorVet**

Pin Indexed Yoke

Pin Indexed Yoke. Oxygen only.

JOR541 \$45.00/ea **BUY NOW**

Ceiling Dial Flowmeter

Many ceiling drops and wall outlets can be connected and a flow meter easily setup. Outlet end is a male DISS fitting. Possible connections include (JOR655) clear oxygen tubing

JOR534EC \$94.00/ea **BUY NOW**

Wall Mount Dial Flow Meter

Chemtron male connect with dial flowmeter 1-15 LPM. Outlet end is a male DISS fitting.

JOR534EW \$87.00/ea **BUY NOW**

Dial Flowmeter w/Female DISS & Male DISS



Wall style Quick release female DISS flowmeter, can hook right to male DISS i.e. "H" tank regulator. Dial flowmeter 1-15 LPM. Outlet end is a male DISS fitting.

JOR534EFM \$75.00/ea

Wall Style Ohio Male Quick Connect w/Male

JOR534EA \$94.00/ea **BUY NOW**

Anesthesia Products

Endotracheal Tubes

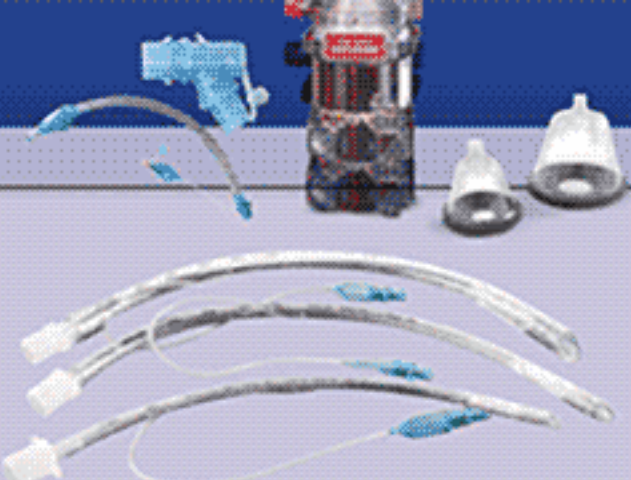

Cuffed Endotracheal Tube **BUY NOW**

Murphy type high volume low pressure. Made of thermosensitive clear PVC that softens at body temperature. Radiopaque line to confirm correct tube placement by X-ray. The smooth tip helps to minimize trauma during intubation. Oral or nasal intubation.

Magill Curve. Murphy Eye. Sterile. Single Use.

END03.0C	3.0mm	\$1.99/ea	END06.5C	6.5mm	\$1.99/ea	END010.0C	10.0mm	\$1.99/ea
END03.5C	3.5mm	\$1.99/ea	END07.0C	7.0mm	\$1.99/ea	END010.5C	10.5mm	\$14.00/ea
END04.0C	4.0mm	\$1.99/ea	END07.5C	7.5mm	\$1.99/ea	END011.0C	11mm	\$14.00/ea
END04.5C	4.5mm	\$1.99/ea	END08.0C	8.0mm	\$1.99/ea	END012.0C	12.0mm	\$16.00/ea
END05.0C	5.0mm	\$1.99/ea	END08.5C	8.5mm	\$1.99/ea	END013.0	13.0MM	\$14.00/ea
END05.5C	5.5mm	\$1.99/ea	END09.0C	9.0mm	\$1.99/ea			
END06.0C	6.0mm	\$1.99/ea	END09.5C	9.5mm	\$1.99/ea			

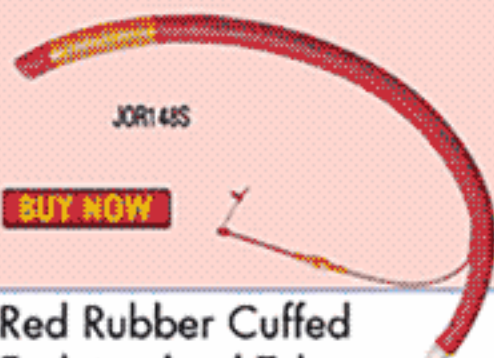

JOR148S

BUY NOW

Red Rubber Cuffed Endotracheal Tube

Available in .5mm increments from 2.5 to 16.0mm. Murphy eye. Red rubber. Hard-to-find extra-large size now available. (adaptor not included except where specified)

JOR148A	2.5mm	\$28.50/ea	JOR148M	8.5mm	\$28.50/ea
JOR148B	3.0mm	\$28.50/ea	JOR148N	9.0mm	\$28.50/ea
JOR148C	3.5mm	\$28.50/ea	JOR148O	9.5mm	\$28.50/ea
JOR148D	4.0mm	\$28.50/ea	JOR148P	10.0mm	\$28.50/ea
JOR148E	4.5mm	\$28.50/ea	JOR148Q	10.5mm	\$28.50/ea
JOR148F	5.0mm	\$28.50/ea	JOR148R	11.0mm	\$28.50/ea
JOR148G	5.5mm	\$28.50/ea	JOR148S	12.0mm, w/adaptor	\$115.80/ea
JOR148H	6.0mm	\$28.50/ea	JOR148T	13.0mm, w/adaptor	\$115.80/ea
JOR148I	6.5mm	\$28.50/ea	JOR148U	14.0mm, w/adaptor	\$119.50/ea
JOR148J	7.0mm	\$28.50/ea	JOR148V	16mm, w/adaptor	\$119.50/ea
JOR148K	7.5mm	\$28.50/ea			
JOR148L	8.0mm	\$28.50/ea			

Jor-Vet Cuffed Endotracheal Tube

Softens at body temperature, reducing postoperative irritation. Blue-tinted PVC tube complete with connector. Available in 0.5mm increments from 3.5mm to 11mm

BUY NOW

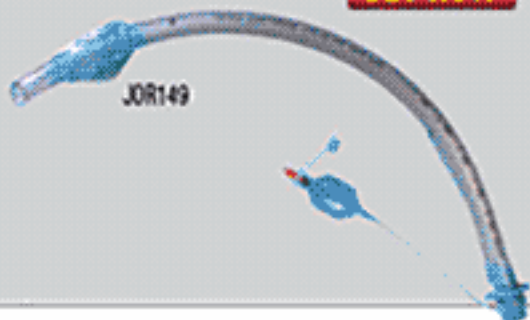

JOR149

JOR149A	5.0mm	\$4.50/ea	JOR149VC	3.5mm	\$6.90/ea
JOR149B	5.5mm	\$4.50/ea	JOR149XC	4.0mm	\$7.05/ea
JOR149C	6.0mm	\$4.50/ea	JOR149YC	4.5mm	\$6.90/ea
JOR149D	6.5mm	\$4.50/ea			
JOR149E	7.0mm	\$4.50/ea			
JOR149F	7.5mm	\$4.59/ea			
JOR149G	8.0mm	\$4.59/ea			
JOR149H	8.5mm	\$4.59/ea			
JOR149I	9.0mm	\$4.65/ea			
JOR149J	9.5mm	\$4.50/ea			
JOR149K	10.0mm	\$4.65/ea			
JOR149L	10.5mm	\$4.65/ea			
JOR149M	11.0mm	\$4.65/ea			

Non-Cuffed

JOR149T	2.5 mm	\$4.35/ea
JOR149U	3.0mm	\$4.35/ea
JOR149V	3.5mm	\$4.35/ea
JOR149Y	4.5 mm	\$4.35/ea

Endotracheal Tube Stylet

Cuffed Endotracheal Tube. Softens at body temperature, reducing postoperative irritation. Blue-tinted PVC tube complete with connector. Available in 0.5mm increments for 3.5mm to 11mm.

JOR149STL	5mm6mm	\$20.70/ea
JOR149STS	2mm2mm	\$20.70/ea

Anesthesia Products

Endotracheal Tubes

Silicon Endo Tube w/Connector

Silicone is the preferred material for endotracheal tubes. However, until now the cost was considered too high for use in most veterinary clinics. This is especially true on the larger sizes above 10mm.

- Endotracheal tube with inflatable cuff
- Connector included
- Lateral Murphy eye at distal tip
- Sizes 3mm to 14mm
- Fully transparent
- Silicone Material Benefits:
 - Patient comfort. Silicone is a soft material that conforms to body contours. The soft distal tip lessens the chance for any airway tissue damage.
 - Reusability. Intended to be used over and over again. Silicone resists deterioration better than PVC or red rubber
 - Transparent. See any blood and mucous if they develop.

Series JOR615

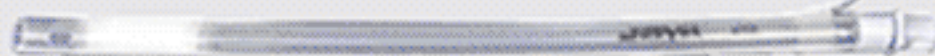

JOR615A	Endotracheal Tube. 3mm I.d. 14fr 4.7mm o.d. 16cm L balloon 3cm L	\$9.90/ea
JOR615B	Endotracheal Tube. 4mm I.d. 18fr 6.0mm o.d. 18cm L balloon 3cm L	\$9.90/ea
JOR615C	Endotracheal Tube. 5mm I.d. 20fr 7.3mm o.d. 20cm L balloon 4cm L	\$9.90/ea
JOR615D	Endotracheal Tube. 6mm I.d. 28fr 8.7mm o.d. 28cm L balloon 4cm L	\$9.90/ea
JOR615E	Endotracheal Tube. 7mm I.d. 30fr 10.0mm o.d. 30cm L balloon 5cm L	\$11.70/ea
JOR615F	Endotracheal Tube. 8mm I.d. 33fr 11.0mm o.d. 33cm L balloon 5cm L	\$11.70/ea
JOR615G	Endotracheal Tube. 9mm I.d. 37fr 12.3mm o.d. 34cm L balloon 5cm L	\$13.20/ea
JOR615H	Endotracheal Tube. 10mm I.d. 43fr 14.3mm o.d. 36cm L balloon 5cm L	\$18.00/ea
JOR615J	Endotracheal Tube. 11mm I.d. 47fr 15.7mm o.d. 40 cm L balloon 5cm L	\$22.50/ea
JOR615K	Endotracheal Tube. 12mm I.d. 51fr 17.0mm o.d. 44cm L balloon 5cm L	\$25.50/ea
JOR615M	Endotracheal Tube. 14mm I.d. 57fr 18.0mm o.d. 48cm L balloon 5cm L	\$33.00/ea

BUY NOW

NOTE: Not autoclavable.

Sheridan Endotracheal Tube Cuffed

BUY NOW

Sheridan Endotracheal Tube. High quality clear PVC tubes but are inexpensive. Uniform inflatable cuff.

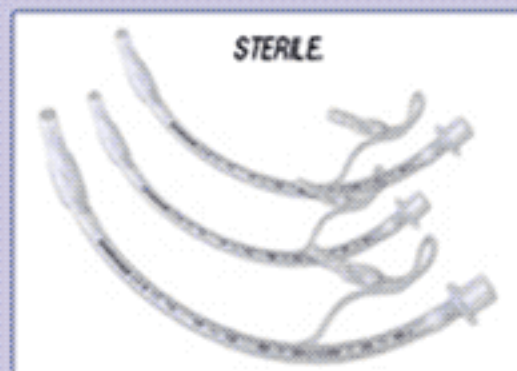

JOR835B	3.5mm	\$5.25/ea
JOR835C	4.0mm	\$5.25/ea
JOR835D	4.5mm	\$5.25/ea
JOR835F	5.5mm	\$5.25/ea
JOR835G	6.0mm	\$5.25/ea
JOR835J	7.0mm	\$5.25/ea
JOR835K	7.5mm	\$5.25/ea
JOR835M	8.0mm	\$5.25/ea
JOR835N	8.5mm	\$5.25/ea
JOR835P	9.0mm	\$5.25/ea
JOR835Q	9.5mm	\$5.25/ea
JOR835R	10.0mm	\$5.25/ea

Oversized Small Animal Endotracheal Tube

Oversized Small Animal Endotracheal Tube. Gray PVC material with white inflatable cuff. Includes adaptor. 21" L (52cm).



JOR835W	11mm X 52Cm	\$34.80/ea
JOR835X	12mm X 52Cm	\$34.80/ea
JOR835Y	13mm X 52Cm	\$34.80/ea
JOR835Z	14mm X 52Cm	\$34.80/ea

Avian/Small Exotic Cole Endotracheal Tube

Perfect for the smallest of patients. Lower profile on the distal end aids in proper placement, and larger proximal end helps form a tighter seal. Stepped-down "Cole"-style wall. Silicon. Complete with attached standard 15mm connector.

JOR152M	1.0mm	\$20.25/ea
JOR152N	1.5mm	\$16.50/ea
JOR152A	2.0mm	\$22.50/ea
JOR152B	2.5mm	\$21.00/ea
JOR152C	3.0mm	\$21.00/ea
JOR152D	3.5mm	\$24.00/ea
JOR152E	4mm	\$21.00/ea
JOR152F	5mm	\$24.00/ea
JOR152G	6mm	\$18.00/ea

BUY NOW

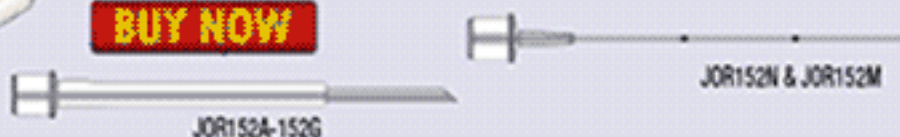

JOR152A-152G

JOR152N & JOR152M

13822 WEST BOULTON BLVD. METTAWA, IL 60045

WWW.SHOPMEDVET.COM

Phone 800-544-7521

309

Fax 800-204-2177

Anesthesia Products

Endotracheal Tubes

Jorvet Silicon Endotracheal Tube with Wire Reinforcement **BUY NOW**

Silicone is a great material for endotracheal tubes because it provides superior biocompatibility and flexibility. These tubes have a metal wire reinforcement that spirals the length of the tube. This reinforcement gives rigidity and prevents any possible occlusion.

Features:

- Graduations to aid in depth placement
- Radiopaque line for location confirmation
- Fully transparent to allow observation for development of blood or mucus
- Lateral Murphy eye
- 15mm connector included

Cuffed

JOR629E	6.0mm I.d. 8.7mm/20fr o.d. 280mm L.	\$16.50/ea
JOR629F	7.0mm I.d. 10.0mm/30fr o.d. 300mm L.	\$16.50/ea
JOR629G	8.0mm I.d. 11.3mm/34fr o.d. 320mm L.	\$16.50/ea
JOR629H	9.0mm I.d. 12.7mm/38fr o.d. 340mm L.	\$16.50/ea
JOR629J	10.0mm I.d. 14.0mm/42fr o.d. 360mm L.	\$16.50/ea

Un-Cuffed

JOR629A	2.5mm I.d. 4.0mm/12fr o.d. 140mm L.	\$10.50/ea
JOR629B	3.0mm I.d. 4.7mm/14fr o.d. 160mm L.	\$10.50/ea
JOR629C	4.0mm I.d. 6.0mm/18fr o.d. 200mm L.	\$10.50/ea
JOR629D	5.0mm I.d. 7.3mm/22fr o.d. 240mm L.	\$10.50/ea



JorVet

Swine Extra-Long 8mm Silicon Endotracheal Tube **BUY NOW**

Especially designed with the cooperation of leading research centers for use in swine. Silicone. Graduated marking with standard adaptor, inflatable cuff, radio-paque, and lateral Murphy eye. Extra-long length. 8mm i.d. x 18"(47cm).

JOR615X	8mm I.d. x 18"(47cm)	\$12.00/ea
---------	----------------------	------------

Silicone Adhesive for Repair of Endotube Cuffs

JOR151AT	for repair of endotube cuffs, Must be purchased separately	\$18.75/ea
----------	--	------------



Cuff Repair Kit **BUY NOW**

Adhesive glue not included. JOR151 AT

JOR151XCRC	22mm	\$16.00/ea
JOR151YRC	24mm	\$16.50/ea
JOR151YARC	26mm	\$16.00/ea
JOR151ZRC	30mm	\$16.00/ea



Silicone Adhesive **BUY NOW**

Silicone adhesive for repair of endotube cuffs.

JOR151AT	for repair of endotube cuffs, Must be purchased separately	\$18.75/ea
----------	--	------------



Equine Silicon Endotracheal Tube **BUY NOW**

Universal fitting allows connection to most large animal anesthesia machines and ventilators.

JOR151XA	16mm I.d. 8cm L Balloon 70cm L Total	\$99.00/ea
JOR151XB	18mm I.d. 8cm L Balloon 75cm L Total	\$113.00/ea
JOR151X	20mm I.d. 10cm L Balloon 90cm L Total	\$156.00/ea
JOR151Y	24mm I.d. 12cm L balloon 100cm L total	\$130.00/ea
JOR151Z	30mm I.d. 14cm L balloon 100cm L total	\$204.00/ea

FREE DIGITAL CAMERA
with required purchase
See Inside Cover for Details

Anesthesia Products

Endotracheal Tube Supplies

Jorvet Endotracheal Tube Stylet

Intubation is made easier when using a rigid stylet for the endotracheal tube. This stylet is a plastic coated malleable metal wire. One end has a rubber stopper that fits tightly over the endotracheal tube connector. It can slide to adjust for proper length. This stylet works especially well with silicon tubes that are less rigid than other tubes. **BUY NOW**

JOR149STA	Fits Tubes Sizes 2.0-3.5mm	\$9.45/ea
JOR149STB	Fits Tubes Sizes 4.0-6.5mm	\$9.45/ea
JOR149STC	Fits Tubes Sizes 7.0-10.0mm	\$9.45/ea

Jorvet Endotracheal Tube Cleaning Brush

JOR151S	8.0mm, cleans >= 8.0mm tubes	\$6.30/ea
JOR151Q	4.0mm, cleans >= 5.0mm tubes	\$6.30/ea

Jorvet Endotracheal Tube Rack

Attractive and convenient way to store up to 20 endotracheal tubes. The rack keeps tubes arranged by size for quick access in any emergency. It attaches easily to most wall surfaces by four adhesive strips or metal screws (included). 20" x 11" 4 lbs.

JOR160	20" x 11", 20 Tubes	BUY NOW	\$78.00/ea
--------	---------------------	----------------	------------

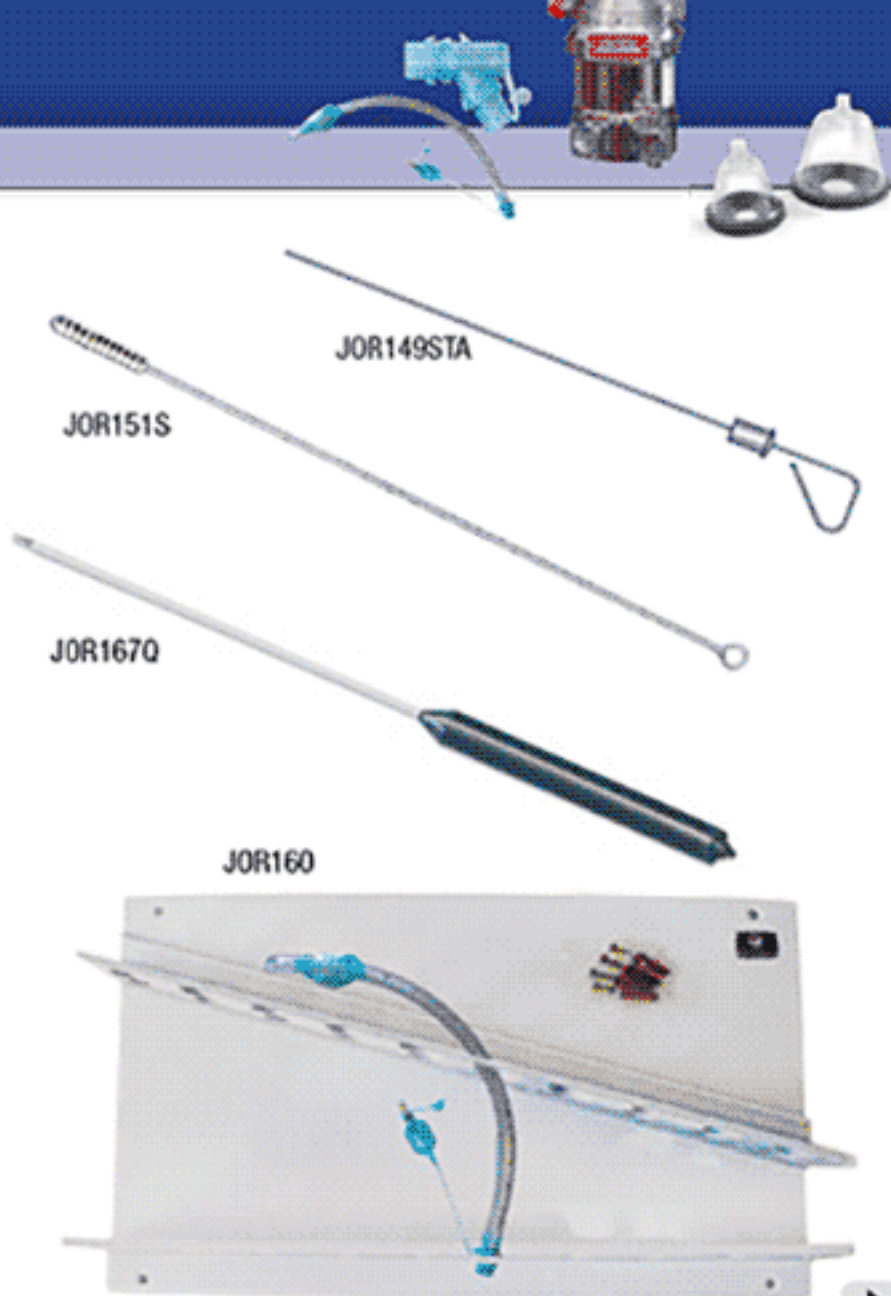

Jorvet Endotracheal Tube Adapter

Portex Endotracheal Adaptor The full range of small animal endotracheal tubes is covered by the twelve adaptors. The adaptors may be sterilized by conventional methods. The compact Swivel Connector may be rotated a full 360 degrees affording maximum positioning and flexibility. For use on all endotracheal tubes. **BUY NOW**

JOR157A	2.5mm	\$2.40/ea	JOR157HH	7.5mm	\$2.40/ea
JOR157AA	3.0mm	\$2.40/ea	JOR157I	8.0mm	\$2.40/ea
JOR157AAA	3.5mm	\$2.40/ea	JOR157II	8.5mm	\$2.40/ea
JOR157B	4.0mm	\$2.40/ea	JOR157J	9.0mm	\$2.40/ea
JOR157C	4.5mm	\$2.40/ea	JOR157JJ	9.5mm	\$2.40/ea
JOR157D	5.0mm	\$2.40/ea	JOR157K	10.0mm	\$2.40/ea
JOR157E	5.5mm	\$2.40/ea	JOR157KK	10.5mm	\$2.40/ea
JOR157F	6.0mm	\$2.40/ea	JOR157L	11.0mm	\$2.40/ea
JOR157G	6.5mm	\$2.40/ea	JOR157T	12.0mm	\$3.05/ea
JOR157H	7.0mm	\$2.40/ea	JOR157	Complete Set	\$65.00/set



Jorvet Swivel Connector

Swivel Connector. Allows movement between endotracheal tube and anesthesia circuit

JOR157S	\$5.10/ea
---------	-----------



One Way Valve for Endo Tube **JOR157Z** **\$1.50/ea**

Connectors



Humidification Management Exchanger **BUY NOW**

In human anesthesia the prevention of moisture and heat loss is a critical consideration. The smaller patient is especially a concern because hypothermia is more likely to occur. Humidification management exchangers are routinely used in human anesthesia. Veterinarians are starting to recognize the value of these products and make them part of their anesthetic regime.

The Humid-Vent is a compact connector that is a heat and moisture exchanger. They are placed in the breathing circuit between the "Y" piece (or "T" piece for non-re-breathing) and the endotracheal tube. Inside the connector is a special medium consisting of hygroscopic, naturally absorbent microwell paper. The Humid-Vent can be used up to 24 hours. After 24 hours they lose their effectiveness and must be replaced. In veterinary use they are typically replaced weekly. 5/box.

JOR606	0-11 lbs., 2.4ml, 10-50ml, 1.2cm H2O @ 7 lpm	\$56.40/ea
JOR606A	11-75 lbs., 10.0ml, 50-600ml, 0.3cm H2O @ 20 lpm	\$28.85/ea
JOR606B	over 75 lbs., 25ml, 150-1500ml, 0.2cm H2O @ 20 lpm	\$44.40/ea

Cage-Mounted Humidifier w/Flowmeter **Jorvet**

This oxygen delivery system will attach to any cage.

- 15LPM flowmeter
- Bubble humidifier (JOR653) add water or saline
- Attaches to cage bars via two "U" bolts or wide flatwashers
- Choices of male DISS fitting or male Ohio quick release for oxygen hose connection to flowmeter
- Oxygen tubing 7 ft (JOR655) Oxygen catheter 14fr (JOR656) for nasal insertion of "blow by"

JOR953	Male DISS fitting	\$154.00/ea
JOR953O	Male Ohio quick release	\$154.00/ea

Oxygen Divider **Jorvet**

JOR948D	\$12.00/ea
---------	------------

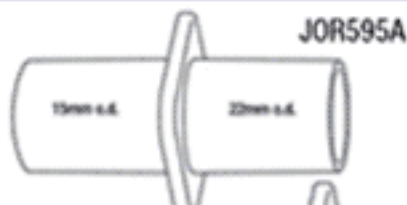

Anesthesia Hose Connector **Dual** fitting polypropylene 2/pkg. **BUY NOW**

JOR595	2 pack, Both ends 22mm/15mm x 22mm/19mm.	\$4.05/ea
JOR595A	2 pack, 22mm o.d. x 15mm o.d.	\$4.05/ea
JOR595B	2 pack, 15mm i.d. x 19mm o.d. x 22mm i.d.	\$4.05/ea



Christmas Tree Connector

Dual fitting polypropylene. One end is a female DISS connector the other a barbed connector. One suggested use is from oxygen regulator connecting oxygen tubing to resuscitator bag. 2/pkg.

JOR595C	2/pkg 2 pk	\$5.10/ea
---------	------------	-----------

BUY NOW

Anesthesia Hose Adaptor 2/pk

JOR595D	22mm i.d. x 22mm o.d.	\$4.05/ea
---------	-----------------------	-----------

BUY NOW

Anesthesia Elbow Connector.

Anesthesia Elbow Connector. **BUY NOW**

JOR595E	2/pk.	\$4.05/ea
---------	-------	-----------

Flush Valve **BUY NOW**

JOR559D9	\$52.00/ea
----------	------------



Section Cut Away Shows Female DISS Threads

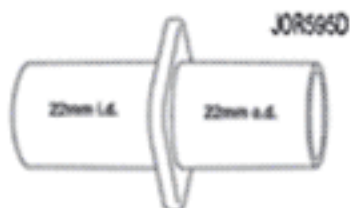

Jorvet Bacterial/Viral Filter

Filter fits onto a standard anesthesia circuit to remove possible pathogens. Bacteria/viral filtration 99.99%+ Dead space 42ml 22mm i.d. x 15mm i.d./22mm o.d. Individually packed. 3/pkg.

JOR756	Bacterial/Viral Filter 3/pkg	\$17.25/ea
--------	------------------------------	------------

Primary Check Removal Tool

JOR537RT	\$60.00/ea
----------	------------

Jorvet



BUY NOW

Jorvet Wye-Connector

Two legs fit standard 22mm anesthesia hoses, and third leg fits 15mm endotracheal tube connectors.

JOR249X	Rigid	\$2.70/ea
JOR249Y	Swivel	\$2.70/ea

Get A FREE AMEX GIFT CARD with your next qualifying order

See inside cover for details

Anesthesia Products

Nebulizer & Oxyhood

Nebulizer Compressor M08

Nebulizer compressor unit with complete accessories. Uses room air to power a medicated nebulizer. Takes about 10 minutes. Mask not included. Uses 110V Size

JOR949M 16.2" x 3.9" x 6.9". Weight 3.5 lbs. \$115.00/ea

Micromist Nebulizer **BUY NOW** w/Tee, Tubing and Mouthpiece

JOR949K Micro-mist and T only \$5.70/ea

Medicated Nebulizer 9cc

JOR949N \$6.75/pk

Air Filters, 12pk (for JOR949)

JOR949D2 \$12.00/12 **BUY NOW**

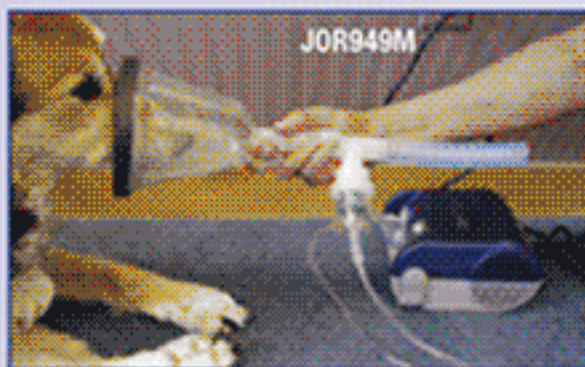

Nebulizer/Compressor

This new sleek design is easy to pick up with break resistant hinges. It remains stable when laying flat on four non-skid rubber feet due to its low center of gravity. Requirements: 115 VAC / 60 Hz; Power Con

HCS60004 Compact size with initial circuit \$345.00/ea



BUY NOW



NEW

JOR653

BUY NOW

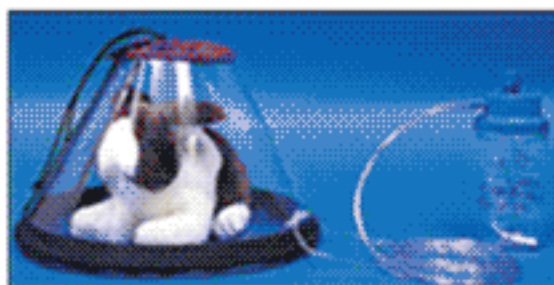

Oxygen Nasal Cannula (4 pack)

This clear tubing delivers oxygen via small plastic tubing to two outlets designed to lay just outside the nares. With universal female connector (i.e. will fit DISS fitting of a flowmeter).

JOR654 \$6.45/pk

BUY NOW

Jorvet Oxygen Catheter

Clear plastic catheter with round tip and side ports for intra-nasal oxygen therapy. Connects to oxygen tubing. (not pictured)

BUY NOW

JOR656 14Fr x 16" (4 pack) \$9.60/pk

JOR656A 16" L x 10fr dia. 4/pk. \$9.60/pk

Jorvet Oxyhood Connector

JOR6520 \$6.15/ea

BUY NOW

Jorvet Oxygen Supply Tubing

Clear plastic with universal female connectors that can connect to DISS male fittings.

BUY NOW

JOR655L 25 ft. (2 pack) \$9.30/pk

JOR655 25 ft. (2 pack) \$10.80/pk

Jorvet Humidifier

This device works by oxygen bubbling through a diffuser in a fluid.

JOR653 \$9.30/ea

BUY NOW

Jorvet Oxyhood

The challenge of delivering oxygen to an animal in respiratory distress is difficult in most veterinary clinical situations. An oxygen cage or an ICU unit is an expense beyond the budget of most clinics. The hand held use of anesthesia masks or nasal cannula is stressful to the animal and labor intensive. The Oxy Hood was developed to deliver oxygen in a less restrictive and stressful environment. The Oxy Hood uses the conventional cone shape of an Elizabethan collar and adds a clear plastic "lid" over the end. Numerous vent holes throughout the cone allows the excess gas to vent. Oxygen is provided to the Oxy Hood via a nasal cannula attached to the hood. The oxygen source uses a bubble humidifier to prevent drying of the respiratory tract.

Features:

- Collar is sewn to nylon fabric with a drawstring, plus velcro attachment allows for proper neck sizing
- Lid, or face of unit is attached with zipper
- Clear plastic material is used throughout for better observation and for the animal to see clearly
- Four sets of holes die cut to allow ventilation of carbon dioxide and to maintain the oxygen level at more than 60 percent
- Very small animals can be placed totally in the larger Oxy Hood like an oxygen tent
- Complete with humidifier, oxygen nasal cannula, and oxygen tubing

JOR652A Small. Cats and dogs 15 lbs. \$48.00/ea

JOR652B Medium. Animals 15-30 lbs. \$58.50/ea JOR654

JOR652C Large. Animals 30-60 lbs. \$72.00/ea

JOR652S Set of all 3 sizes. \$166.00/pk



BUY NOW

13822 WEST BOULTON BLVD. METTAWA, IL 60045

31/3

WWW.SHOPMEDVET.COM

Phone 800-544-7521

Fax 800-204-2177

Anesthesia Products

Laryngoscope Handles and Blades

Laryngoscope Handle

LAR-S	Small (Uses AA Battery)	\$12.80/ea
LAR-M	Medium (Uses C Battery)	\$12.80/ea

BUY NOW

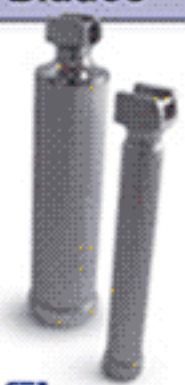

Laryngoscope Handle **JorVet**

Special Penlight Handle only. Works great for cats.

JOR449P	\$30.00/ea	BUY NOW
JOR449M	\$30.00/ea	



Handle Only

Laryngoscope Blades. **BUY NOW**

Miller Laryngoscope Blade

Straight shaft with gentle curved tip.

JOR449A	53mm	\$54.00/ea
JOR449B	80mm	\$54.00/ea
JOR449C	130mm	\$54.00/ea
JOR449D	173mm	\$54.00/ea
JOR449E	180mm	\$54.00/ea

Designed to work for swine intubations.

JOR449F	12" Length	\$88.00/ea
---------	------------	------------



McIntosh Laryngoscope Blade **BUY NOW**

Curved along entire length of blade.

JOR449AM	60mm	\$39.00/ea
JOR449BM	66mm	\$39.00/ea
JOR449CM	85mm	\$39.00/ea
JOR449DM	110mm	\$39.00/ea
JOR449EM	140mm	\$39.00/ea
JOR449F	12" Length	\$88.00/ea



Macintosh Laryngoscope Blade

Med-Vet features two different types of laryngoscope blades.

These high quality laryngoscope blades are made from the finest surgical grade stainless steel and come complete with standard lamps.

MAC-0	Size 0	\$19.95/ea	BUY NOW
MAC-1	Size 1	\$19.95/ea	
MAC-2	Size 2	\$19.95/ea	
MAC-3	Size 3	\$19.95/ea	
MAC-4	Size 4	\$19.95/ea	



Miller Laryngoscope Blade **BUY NOW**

These high quality laryngoscope blades are made from the finest surgical grade stainless steel and come complete with standard lamps.

MIL-0	Size 0	\$19.95/ea
MIL-1	Size 1, 80 mm	\$19.95/ea
MIL-2	Size 2, 130 mm	\$19.95/ea
MIL-3	Size 3, 173 mm	\$19.95/ea
MIL-4	Size 4, 180 mm	\$19.95/ea



Laryngoscope Kit **BUY NOW** (6 blades w/ med.handle)

A handy kit in a black leatherette zipper pouch.

Includes:

- 3 Macintosh blades #1, #2, and #4
- 3 Miller blades #1, #2, and #4
- 1 medium handle

JOR449S	\$279.00/ea
---------	-------------



Laryngoscope Bulbs

Laryngoscope Bulb

BUY NOW

5336	Small	\$3.99/ea
5337	Large	\$3.99/ea

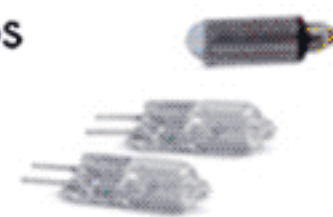

Laryngoscope Replacement Light Bulb

Long Bulb. Used for JOR449b through JOR449f and JOR449bm through JOR449em blades. Sizes 12 mm and 6mm.

JOR449RL	\$9.00/ea	BUY NOW
----------	-----------	----------------

Short Bulb. Used for JOR449a through JOR449am blades. Sizes 10mm and 3mm.

JOR449R	\$7.50/ea	BUY NOW
---------	-----------	----------------

Anesthesia Products

Anesthesia Circuits

Jackson Rees **BUY NOW** Anesthesia Circuit

Modified Jackson Rees Circuits Non-rebreathing circuit. This model has a side vent above the bag and is closed by sliding an on/off button for "bagging an animal." Bag does not have a tail bleed on its end. Complete circuit w/ 1-liter bag

JOR248G Jackson Rees With 1L Bag \$18.00/ea

Disposable Adult **BUY NOW** Anesthesia Circuit

Adult disposable anesthesia breaking circuit consists of two 40" breathing tubes (7/8"), inhaler "Y" and mask elbow. natural color

JOR248D With 3 Ltr Bag \$13.50/ea

JOR248C Without 3 Ltr Bag \$10.65/ea

Disposable Ayers **BUY NOW** Non-Rebreathing Circuits

Disposable Ayers Non-Rebreathing Circuits. For very small patients (under 10 lbs) who cannot use rebreathing systems due to dead space complications.

JOR248E 1/2L Bag \$21.00/ea

JOR248EA 1L Bag, with Tail Bleed Valve \$25.50/ea

Esophagostomy Tube

JOR390 14ft x 9" Not Pictured \$7.20/ea

Universal "F" **BUY NOW** Anesthesia Circuit

This is the popular uni-limb circuit that is a tube within a tube circuit.

Features:

- One 40" hose for lighter weight and maneuverability around the patient's head.
- Exhaled gas warms up incoming fresh gas.
- Attaches to any standard anesthesia machine.

JOR248FL 60" hose 2 liter \$30.00/ea

Adult Universal "F" **BUY NOW** Anesthesia Circuit

This is the popular uni-limb circuit that is a tube within a tube circuit. Includes one 40" hose for lighter weight and maneuverability around patients head. Exhaled gas warms up incoming fresh gas. Attaches to any standard anesthesia machine.

JOR248F With 2L Bag \$24.00/ea

JOR248FA Without Bag \$24.00/ea

Universal "F" **BUY NOW** Anesthesia circuit **Jorvet**

JOR248FLA 60" Hose w/o Bag \$24.00/ea

Pediatric "F" **BUY NOW** Anesthesia Circuit

JOR248KLA 60" Hose w/o Bag \$21.00/ea

Pediatric Universal "F" **BUY NOW** Anesthesia Circuit

For animals weighing 4kg 20kg.

Features:

- Smaller diameter tubing with less dead space than standard uni-limb system
- Pink colored inner tubing 40"
- One 40" hose

JOR248KL 60" Hose 2 Liter \$27.00/ea

Pediatric Universal "F" **BUY NOW** Anesthesia Circuit

For smaller animals weighing between 4kg and 20kg. Includes a smaller diameter tubing with less dead space than the standard uni-limb system. Pink inner tubing.

JOR248K With 1L Bag \$24.00/ea

JOR248KA Without Bag \$18.00/ea

Disposable Pediatric **BUY NOW** Anesthesia Circuit

For use with smaller patients, this lessens the amount of dead space. Consists of two 30" breathing tubes (5/8"), inhaler "Y" piece and mask elbow. Clear color.

JOR248A Without 1 Ltr. Bag \$10.80/ea

JOR248B With 1 Ltr Bag \$12.75/ea

JOR248A



JOR248E



JOR248FA



JOR248D



JOR248G



JOR248K

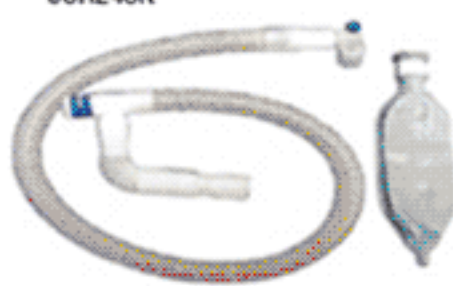

Blood Collection, Tubes & Centrifuges

Blood Collection Tube Red Top

Serum tubes have spray-coated silica and are used for serum determinations in chemistry, serology, and immunohematology.

RED3.0	3/4ml Red Plain 100/bx	\$17.50/bx
RED5.0	5ml Red Plain 100/bx	\$20.50/bx
RED7.0	7ml Red Plain 100/bx	\$26.95/bx
RED10.0	10ml Red Plain 100/bx	\$28.81/bx



BUY NOW

Blood Collection Tube EDTA

Spray-coated EDTA Tubes are used for whole blood hematology determinations and immunohematology testing.

LAV2.0	2ml Lav. Edta 100/bx	\$16.00/bx
LAV3.0	3ml Lav. Edta 100/bx	\$16.00/bx
LAV4.0	4ml Lav. Edta 100/bx	\$16.00/bx
LAV7.0	7ml Lav. Edta 100/bx	\$26.69/bx



BUY NOW

Blood Collection Set

7283 23 x 3/4 each \$0.50/ea

BUY NOW

Full View Test Tube Supports and Dry Rack Combined

Tubes can be stored upright full or empty or can be inverted over pins for drying. Polypropylene. Steam autoclavable. 50 tube places in 5 x 10 configuration. 66 drying pins.

JOR352D 10cm W x 18cm L x 6.7cm H. White. Tubes not included. \$46.80/ea

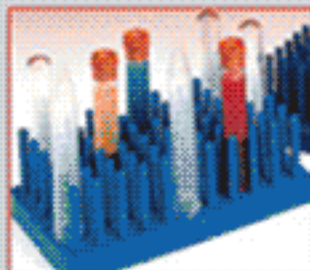

Test Tube Pack with Color Comparator

The white surface background aids in test tube evaluation or comparison. Holds up to 14 tubes of various sizes and has 6 drying pins.

JOR352E 4 1/2"W x 8"L x 3 1/2"H. \$30.00/ea



BUY NOW

Heartworm Rack

Commonly used for heartworm testing. Holds 72 micro-sample tubes.

JOR352H 8 3/8" x 3/8" x 4 3/8". \$51.00/ea



BUY NOW

Rubber Tube Cushion

JOR501TC Cushion Only \$3.00/ea

Serum Separation Tubes

Tubes contain spray-coated silica and a polymer gel for serum separation. They are used for serum determinations in chemistry. Tubes provide an efficient means of serum sample preparation and help to improve laboratory workflow.

SST4.0	4ml SST 100/bx	\$30.00/bx
SST8.5	8.5/9.5ml SST 100/bx	\$34.00/bx



BUY NOW

Wire Test Tube Rack

Tough. Corrosion-resistant. Epoxy coated. Three-layered deck with square holes. Holds 72 tubes in a 6 x 12 configuration. Measurements: 2 5/8" tall x 5 1/8" wide x 9 1/2" long.

JOR352 6 X 12, holds 72 Tubes \$38.70/ea



BUY NOW

Universal Cap for Test Tubes

This cap will work on almost all laboratory test tubes. It will fit 12mm, 13mm, and 16mm test tubes. Note JOR546A 15ml, centrifuge tube has a 16mm diameter opening.

JOR546C Green color, 100pk \$6.15/ea



Screw Cap Test Tube

JOR547A 16ml \$24.00

Acrylic Blood Tube Rack

Organize your blood collection tubes. This rack can hold over 200 tubes in various compartments. Separate tubes by color and size. It can be wall mounted or placed on a counter top.

JOR885 12"W x 16"H x 5 1/2"D \$93.00/ea



BUY NOW

Test Tube Rocker

Its gentle back and forth motion is designed to protect blood samples from clotting before they can be evaluated. Ideal for blood collection tubes. Smooth mixing action for consistent uniform specimen suspension.

JOR819 Large Blood Rocker, Holds 16 tubes. 13 3/4" x 4 1/3" x 5 1/2". 5 1/2 lbs. \$366.00/ea

JOR819A Small Blood Rocker, Holds 8 tubes. 7 1/2" x 4 1/3" x 5 1/2". 3 lbs. \$470.00/ea



BUY NOW



Twirl'em Pack, Pipettes, & Beakers/Specimen Cups

Twirl'em Pack

BUY NOW

JorVet

The affordable sterile container. Ideal for transport of solids, semi-solids, or liquids. Similar to Whirl packs.

- Heavy-gauge transparent polyethylene
- Double bottom seam
- Can write on printed surface
- 3" x 7" (76mm x 127mm)
- 4 oz. (120ml) capacity
- 100/case



JOR557 3" x 7", 100-pack

\$20.10/pk



Infusion Pipettes

BUY NOW

JorVet

High quality PVC pipette with rounded polished insertion end to prevent tissue trauma. Large bore, manufactured with the following specifications; 0.160 i.d. x 0.225 o.d. for infusing viscous fluids. All tubes 25/poly bag.

JOR287A	18", flex adaptor, 25 pk.	\$7.95/pk
JOR287B	18", drilled, 25 pk.	\$5.85/pk
JOR287C	21", flex adaptor, 25 pk.	\$8.55/pk
JOR287D	21", drilled, 25 pk.	\$5.85/pk
JOR287E	21", drilled, sterile	\$16.90/bg
JOR287F	21", flex adaptor	\$18.60/bg



Jorvet Pipette Tips

JorVet

JOR857A	1ml, 500pk	\$16.80/pk
JOR857B	5ml capacity, 300pk	\$45.00/pk

BUY NOW

Extra-Large Bore Pipettes

1/4" x 25". Non-sterile. 25/bag.

JOR286P	Non-Sterile, 25pk	\$25.50/pk
JOR286S	Sterile, 25-pk	\$35.10/pk



Disposable Transfer Pipettes

General laboratory use from serum to urine. Single use clean polyethylene. Three sizes available.

BUY NOW

JOR353	7.0ml Pipette, 6"L. 22 drops/ml. Graduations up to 3ml. 50/pk. (Most popular size.)	\$12.00/bg
JOR353A	7.0ml Pipette, 6"L. 22 drops/ml. Graduations up to 3ml. 500/pk. (Most popular size.)	\$28.95/bg
JOR353B	3.0ml Pipette, 5 1/2"L. 25 drops/ml. Graduations up to 1 ml. 50/pk.	\$4.80/pk
JOR353C	3.0ml Pipette, 5 1/2"L. 25 drops/ml. Graduations up to 1 ml. 500/pk.	\$31.80/pk
JOR353D	1.7ml Pipette, 3 1/2"L. 25 drops/ml. No graduations. 50/pk.	\$5.10/pk
JOR353E	1.7ml Pipette, 3 1/2"L. 25 drops/ml. No graduations. 500/pk.	\$28.80/pk

Jorvet Mini Pet Pipette

BUY NOW

Deliver precise and accurate volumes of lab samples through an inexpensive, reusable pipettor. Constructed of durable molded colorful plastic that performs nicely for routine clinical lab procedures that requires specific volumes delivered.

JOR354 The MiniPets pipettors use the 0.2ml capacity disposable pipettes. \$99.00/ea



Pipette Tips

BUY NOW

Tips are manufactured using high quality raw materials and the latest molding techniques and are designed using the knowledge of liquid handling.

A18 2-13/16" 250/BX \$4.99/bx



Plastic Graduated Transfer Pipettes

Made of low-density polyethylene, non-sterile, graduated. These unbreakable all-in-one pipettes eliminate the hazards of broken glass and exposure to infectious materials.

PTP-01	3ml gradations, 7ml capacity, 500/bx	\$15.80/bx
PTP-02	1ml gradations, 5ml capacity, 500/bx	\$15.80/bx

BUY NOW



Fixed Volume Pipettor

Pipettors are widely used in laboratories. They are an accurate method of transferring solutions or reagents. They also reduce exposure to samples or laboratory chemicals. Consisting of two parts, a reusable pipettor draws up fluid through the disposable tip which actually holds the fluid in a preset, precise volume. The fluid never reaches or touches the actual pipettor. The disposable pipettes cost only pennies and are discarded after each use. Pipettors are available in either fixed or adjustable volume. Adjustable Volume Pipettor. 200/pk.

- Easy volume setting by simply turning the plunger
- Streamlined tip for access to narrow containers and tubes

JOR856	0.05ml 200/pk	\$129.50/pk
JOR856A	0.10ml 200/pk	\$196.00/pk
JOR856B	0.50ml 200/pk	\$129.50/pk
JOR856C	1.00ml 200/pk	\$146.00/pk

BUY NOW



Adjustable Volume Pipettor

JOR855	0.02-0.20ml (20-200ul)	\$194.00/ea
JOR855A	0.20-1.00ml (200-1000ul)	\$196.00/ea
JOR855B	1.00-5.00ml	\$202.00/ea



Jorvet 3 Corner Beaker

These graduated beakers are unbreakable polypropylene with built-in pour spouts. Not affected by most chemicals. Beakers are inexpensive enough to be disposable but can be autoclaved and/or reused.

JOR168	50ml, 10 pack	\$5.25/pk
JOR168A	400ml, 10 pack	\$8.40/pk
JOR168B	1000ml, 10 pack	\$12.00/pk

BUY NOW



Sterile Disposable Specimen Container

Graduated specimen container. A leak proof lid. Wide base for stable reliable use. Seal/label assures internal sterility. Green cap.

JOR555 4 oz., (120ml), 100/bag. \$28.50/bg

BUY NOW



Laboratory Equipment & Supplies

Microscope Accessories & Hemacytometer System



Kimwipe (KIMTECH) **BUY NOW**

KIMTECH SCIENCE KIMWIPES Delicate Task Wiper, 3 ply, POP-UP Box, offers a unique combination of low-lint tissue softness and multi-ply absorbency that's perfect for a multitude of delicate tasks.

Kimwipes have multi-ply absorbency, wipes up liquid and dust.

- Delicate task wipers wipe clean with extra low-lint and extractable performance.
- The Industry Standard for Labs and Research
- KIMTECH SCIENCE KIMWIPES Wipers are a versatile option for delicate tasks such as laboratory cleaning, surface/parts cleaning, instrument cleaning and lens cleaning.

34743 12" X 12", 119/bx \$8.95/bx



Microscope Cleaning/Service Kit

This kit will work for any and all microscopes. The microscope is a workhorse in the veterinary clinic. It is routinely exposed to many solutions between laboratory stains, immersion oils, and body fluids. These all can adversely affect the optical performance. Routine cleaning, adjustment, and alignment are a necessary function to get the best diagnostic quality images from your microscope. This job is difficult without the proper tools and instructions. The JorVet microscope cleaning and service kit makes this possible for even the novice microscope user. The kit contains ten different components in a storage case.

- Micro-fiber lens cloth that removes dust and debris from the scope (9" x 9")
- Soft-bristled dusting brush for routine removal of dust and debris
- Set of 3 Allen Wrenches: 1.5mm, 2.0mm, 2.5mm
- Micro-glide gear lubricant
- Precision screwdriver set (6) for very small microscope screws
- Air duster 8 oz. pressurized aerosol can with exterior tube
- Cotton tip applicators (100) for cleaning objectives
- Friction collar small double-sided wrench
- Black nylon zippered storage case. 4" x 7" x 10", 1.9 lbs.
- Detailed illustrated service manual, and a glossary of common microscope terminology



JOR869K \$79.00/ea **BUY NOW**

Microscope Accessories Custom Organizer

Organizer. A wide variety of items accumulate around a microscope station: slides, pipettes, lens paper, cleaning solutions, immersion oil, and cover slips, etc. These all can be organized in an attractive, clear acrylic display of divider boxes. Each divider box has double-sided foam tape for custom attachment to the central station.

JOR869X 11"W x 14"L x 11"H \$120.00/ea **BUY NOW**



Microscope, Immersion Oil

Resolve Oil, High Viscosity, 1/2 oz/15ml, 12/bx

MA57 Resolve Oil, High Viscosity, 1/2 oz/15ml, 12/bx \$7.90/dz

MA56 Resolve Oil, Low Viscosity, 1/2 oz/15ml, 12/bx \$7.90/dz

MA06 Microscope Immersion Oil, Cedar Wood, 2ml \$2.50/ea

Jorvet Immersion Oil

JOR326A 120ml bottle **BUY NOW** \$15.60/bd

"No-Residue" Microscope Lens Cleaning Solution

1 oz. dispensing bottle. **JorVet**

Removes dried residue from objectives.

BUY NOW



JOR869S Use with JOR869 lens tissues. \$9.00/ea

Lint-Free Lens Paper

Tissues. Special grade pop-up sheets remove oil immersion that collects and dries on objectives.

BUY NOW

JOR869 3" x 4 1/2" x 4 1/2", 280/bx. \$6.00/ea
Similar to Kim Wipes.

BUY NOW

Kim Wipes Acrylic Box Holder

Out of your way, but still at your fingertips. Mount Kim Wipes on the wall with these acrylic holders. Easily attaches with double back tape.

BUY NOW

JOR877 130mm x 84mm x 122mm \$18.00/ea

Cadaver Bags **JorVet**

Heavy-duty 4 ml black plastic. Strong enough to handle the sanitary disposal of animals. Full 35" x 48". 25 bags/pk. (not pictured)

JOR108 25 pack \$28.00/pk

Dose Adaptor

Fits all standard luer lock and luer tip syringes.



JOR206 4" \$8.10/ea

BUY NOW

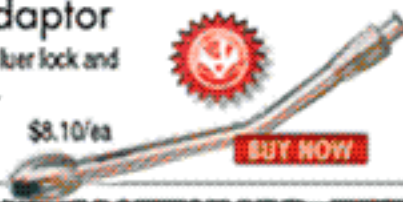

Cell-VU Hemacytometer System Kit

The safety hemacytometer system for use with all manual-counting procedures.

Sperm • CSF • WBC • Urine

Consists of both the slide and cover slips

Slide is dual chambered providing for two determinations per sample

Cover slips are laser-etched grid that is easy to view

JOR821X Each system consists of: 3 slides with dual chamber and 6 cover slips with etched grid Directions for sperm concentration included.

\$28.50/pk



Jorvet Neubauer Hemacytometer

Designed especially for counting blood cells with the "unopette." Double rulings are visible through a wide range of illumination. Neubauer rulings are 0.1mm below cover glass. The "H"-shaped moat offers two counting areas. Fused rhodium on glass provides distinct lines.

JOR821 Fused rhodium on glass provides distinct lines. \$129.00/ea



BUY NOW

JorVet

Lab Eartag Applicator

Has specially designed head where tag slips in easily. Allows for quick and simple placement of tag in ear.

JOR49LTA \$92.00/ea



Jorvet Lab Eartags

These small numbered tags are used extensively in research institutions around the world. The small metal brass tags are perfectly suited for mice and rats. They are easy to apply with metal applicator. (JOR49Lta) Choose numbers 1-10,000. 100/box.

JOR49LT 100 pk. \$36.00/pk

BUY NOW



13822 WEST BOULTON BLVD. METTAWA, IL 60045

WWW.SHOPMEDVET.COM

Phone 800-544-7521

318

Fax 800-204-2177

Microscope Slides & Accessories

Microscope Slides

Pre-cleaned, high quality glass. Hard, colorless, non-corrosive. Ground, polished edges. 1" X 3" 72 per box.

MICROFROST	Frosted, 72/bx	\$2.49/bx
MICROPLAIN	Plain, 72/bx	\$2.49/bx

Microscope Slide

High-quality glass slide that will serve every clinical lab need from permanent mounts to fecal samples.

- Slides individually separated by thin tissue paper to prevent sticking together.
- Smooth edges with beveled corners
- 1" x 3" x 1.2mm (1/25") thick (frosted)

JOR335F	Frosted Edge, 1"x 3", 72/box	\$4.40/bx
JOR335	Clear, 1"x 3", 72/box	\$3.30/bx

Cover Glass **BUY NOW**

Microscope cover glass 1 oz. box #1 thickness 22mm X 22mm

COVERGLASS	22mm x 22mm	\$2.50/bx
------------	-------------	-----------

Glass Cover Slips **BUY NOW**

Ultra-thin glass. 22mm x 22mm (~1" x ~1"). 100/Box.

JOR336	100/box	\$3.10/bx
--------	---------	-----------

Hemocytometer Coverslip

JOR321C	each	\$10.50/ea
---------	------	------------

Plastic Coverslips

Almost unbreakable flexible vinyl cover slip. Interleaved with tissue. 22mm W x 22mm L x 0.157mm (0.007") H. 100/box.

JOR336P	100pk	\$9.15/pk
---------	-------	-----------

McMaster Egg Worm Slide

Special microscope slide with two etched chambers for quantitative fecal analysis.

JOR335M	McMaster Egg Worm Slide	\$67.50/ea
---------	-------------------------	------------

Microscope Slide Holder

These sturdy cardboard slide mailers are designed for safe, easy handling of microscope slides. Reusable

- Holds standard 1" x 3" (2.5mm x 7.6cm) slides with or without cover slip
- Inner groove for easy finger removal
- Extra area for labeling information

JOR337L	for 20 Slides	\$15.60/ea
---------	---------------	------------

Jorvet Slide Storage and Index Box

Provides safe storage. This slide holder set includes twelve 5" x 3" cards. You can sort, group, classify or arrange slides in any order. Each holder consists of a white plastic frame adhered to an index card. They hold 4 slides per card. Index tabs allow for reference and classification. File box constructed of sturdy gray plastic.

JOR816S	Set includes twelve 5" x 3" cards.	\$16.50/ea
---------	------------------------------------	------------

Slide Folder

Our sturdy cardboard folder is specially constructed to reduce bending of the folder. Twenty standard 3" x 1" slides fit into numbered slots with thumb grooves on each side and index on outside cover. Doors are hinged for opening and do not lie directly on the slides when closed. 8 1/4" x 13 1/2" x 5/16" closed.

SLIDE FOLDER	20 slide capacity, Sold individually	\$3.65/ea
--------------	--------------------------------------	-----------

Slide Holder

Details: Sturdy ABS plastic box with our exclusive self locking lid holds up to 25 slides and has cork lined bottom. Index paper in lid corresponds with embossed numerals on bottom of box.

SLIDEHOLDER	25 Slides	\$1.20/ea
-------------	-----------	-----------

Jorvet 2-Place Slide Mailer

These two place slide protectors hold standard microscope slides securely. With large, easy to secure snaps, our polypropylene mailers provide safe storage for valuable slides. Bright neon assorted colors (red, yellow, blue, purple, and orange) are great for color-coding. Inexpensive. 93mm W x 68mm L x 5 mm H. 25/pk assorted colors.

JOR337A	25pk	\$20.40/pk
---------	------	------------

Jorvet Plastic 5-Slide Mailer

Ideal for shipping, storing or staining of slides. These polypropylene containers hold five standard slides. Hinged side opening with secure closure. Slotted channels for slide separation and easy removal.

JOR816X	5/pk. Assorted colors Plastic 5-Slide Mailer	\$6.30/pk
---------	--	-----------

Microscope Slide Box

Each box has slots for each slide. A foam back secures slides. Closes via a clasp and hinge. A chart on inside cover allows for written record of each specific slide.

JOR816R	100-Place Slide Box, Blue, 8 3/4" x 6 3/4" x 1 3/8"	\$16.80/ea
JOR816T	25-Place Slide Box, Red, 5 1/2" x 3 1/2" x 1 1/4"	\$12.30/ea

Jorvet Dual Microscope Slide Holder

These sturdy cardboard slide mailers are designed for safe, easy handling of microscope slides. Reusable Holds standard 1" x 3" (2.5mm x 7.6cm) slides with or without cover slip Inner groove for easy finger removal. Extra area for labeling information

JOR337	2 Pack	\$4.50/pk
--------	--------	-----------

Microscope Slide Dispenser

ABS plastic dispenser releases clean, dust-free microscope slides. Holds 72 standard slides. Turning either side wheel dispenses slides out one at a time. Unique design makes loading of microscope slides very easy. The clear plastic cover allows one to see number of slides remaining.

JOR815	Holds 72 standard slides	\$25.20/ea
--------	--------------------------	------------

Stains, Mortar & Staining Jars

Acid Fast Stain **BUY NOW**

A very useful, specialized stain. Use for identification of: *Johnes* disease, *cryptosporidium*, acid fast organisms. 126ml bottle.

JOR326AS	Kit	\$45.90/ea
JOR326ASD1	Stain #1	\$9.60/ea
JOR326ASD2	Stain #2	\$9.60/ea
JOR326ASD3	Stain #3	\$9.60/ea
JOR326ASD4	Stain #3	\$9.60/ea



Methanol **BUY NOW**

Hazmat material, can only ship ground.

JOR326ASDA	\$7.50/ea
------------	-----------



Dip Quick Stain **BUY NOW**

Excellent for use in blood cell differential counts or as a general cytology stain, and gives coloration similar to the standard Wright-Giemsa stain. The rapid 3-step procedure can be done right in the wide-mouth 180ml. container in 15 seconds.

JOR322	Complete kit	\$33.30/ea
JOR322A	Refill 3x500ml	\$54.00/ea

Individual Refills

JOR322A1	#1 Fixative 500ml	\$22.20/ea
JOR322A2	#2 Eosin 500ml	\$23.70/ea
JOR322A3	#3 Counter stain 500ml	\$25.50/ea
JOR322A2G	Gallon	\$98.00/gl
JOR322A3G	Gallon	\$106.00/gl



JorVet Gram Stain **BUY NOW**

An important stain that has a multitude of uses, i.e., a quick diagnostic check on a swab from a severe otitis or a stain from an isolated culture. 4 x 250ml bottles **JorVet**

JOR323	Kit, 4 x 250ml	\$27.60/ea
JOR323D1	Crystal Violet, 250ml	\$7.50/ea
JOR323D2	Iodine, 250ml	\$10.50/ea
JOR323D3	Decolorizer, 250ml	\$9.75/ea
JOR323D4	Safranin Counter Stain, 250ml	\$9.60/ea

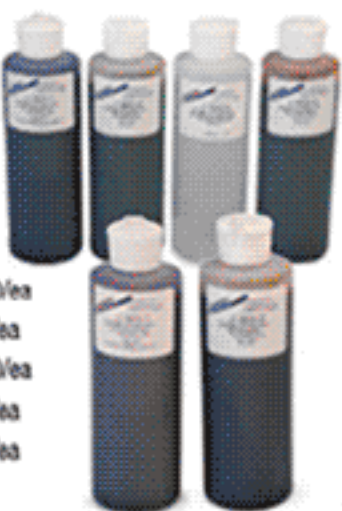

Iodine Stain Kit **BUY NOW**

Stain Concentration. Useful in identifying difficult to see parasites on fecal floatation or wet mounts. These include protozoan parasites like *Giardia*, *Coccidia*, and also helminth parasites. This stain is picked up readily by protozoan nuclear structures and also stains their glycogen masses. Some parasites, like *Giardia* are very difficult to view unless stained in this manner. 500ml with 4 oz. dropper bottle. 2.1% Iodine Stain. 500ml.

JOR325FM	2.1%, 500ml	\$33.30/ea
----------	-------------	------------



Live/Dead Semen Stain **BUY NOW**

A necessary component of any male fertility exam is a microscopic evaluation of sperm morphology. The JorVet Live/Dead Semen Stain is a eosin-nigrosin based stain that will stain sperm from every species. 2 x 7.5 ml bottles per package. Complete with detailed instructions and diagrams of abnormal spermatozoa. Keep refrigerated.

JOR326S	15 ml	\$18.60/ea
---------	-------	------------



Lactophenol Cotton Blue **BUY NOW**

This stain is useful for fungal exams. It is used in combination with the 10 percent KOH (JOR326). First the KOH clears various debris; then the lactophenol cotton blue will stain the fungal elements a deep blue. 120ml.

JOR326B	4 oz.	\$16.20/ea
---------	-------	------------



New Methylene Blue Stain **BUY NOW**

This stain has many veterinary applications, from reticulocyte count to estrus vaginal smears. 250ml.

JOR324A	250ML Methylene blue stain 2 oz	\$8.70/ea
JOR324	250ml	\$21.00/ea



Potassium Hydroxide 10% **BUY NOW**

Useful in dissolving keratin and other debris when examining a slide for fungal components. 250ml.

JOR326	10%, 250ml	\$9.60/ea
--------	------------	-----------



Sudan III Fecal Stain **BUY NOW**

A quick diagnostic test is to use Sudan III stain as an aid in the assessment of maldigestion/malabsorption syndromes. The Sudan III will selectively stain lipid droplets orange on a fecal smear. 250ml.

JOR325	250ml	\$12.60/ea
--------	-------	------------



Coplin Staining Jar **BUY NOW**

The Coplin staining jar is used for holding microscope slides during staining procedures. It is made of polyethylene. Internal grooves hold 6-8 standard slides.

JOR814	50mm base, 114mm H	\$14.85/ea
--------	--------------------	------------



Coplin Glass Jar **BUY NOW**

Clear thick flint glass with internal ridges for separating slides from each other.

JOR814X	with black screw cap lid	\$13.80/ea
---------	--------------------------	------------

0.2 Micron Filter **JorVet BUY NOW**

Filter is used when transferring serum to 6ml syringes. Procedures will require multi filters. Syringe not included. This filter has a female luer lock and male luer lock fitting. Green. 22mm width. sterile. Packaged singles.

JOR1081	Sterile	\$2.60/ea
---------	---------	-----------



pH Checker, Counters & Portable Bunsen Burner

Jorvet Checker pH Meter **BUY NOW**

Small animal veterinarians spend a great deal of time discussing special dietary management and urinary acidifiers for controlling urinary tract disease. The maintaining of urine pH between 6.0 and 6.8 is necessary to minimize struvite crystal formation; usually paper reagent strips are used to determine urine pH through very subtle color changes. Using a pH meter is much more accurate than simple urine reagent strips.

Features:

- Economical, costs less than a bottle of reagent strips
- Fast, easy and highly accurate calibration: 0.2 pH at 68°
- High resolution: reads down to 0.01 pH units
- Small sample required, will fit into small container
- Small lightweight design: 2 1/2 oz with 6" electrode
- Battery operated with 3000 hour life

JOR753 Includes pH meter, screw-on electrode, buffer kit and storage solution. **\$68.50/ea**

Checker pH meter, complete kit, **BUY NOW**

Checker pH Meter Kit. Includes pH meter, screw-on electrode, buffer kit and storage solution.

JOR753K **\$142.50/ea** **BUY NOW**

pH Replacement Electrode **BUY NOW**

JOR753D1 pH Replacement Electrode for Checker pH Meter. **\$38.50/ea**

Buffer Solution pH

JOR753D4 Buffer Kit. 5 packages of each solution for Checker pH Meter **\$32.40/ea**

JOR753D2 Buffer Solution, pH 4. 230ml for Checker pH Meter. **\$24.60/ea**

JOR753D3 Buffer Solution, pH 7. 230ml for Checker pH Meter **\$24.60/ea**

Electrode Storage Solution **BUY NOW**

JOR753D5 Electrode Storage Solution. 230ml for Checker pH Meter **\$21.60/ea**

Jorvet Cell Counter **BUY NOW**

Differential Cell Counter allows the percentage of each type of white blood cells to be counted (leukocytes). Every stroke makes a distinct sound, and when a total of 100 is reached a bell will ring.

JORS05A 5 key **\$195.00/ea**

JORS05B 8 key **\$220.00/ea**

Hand Held Tally Counter

Used for counting blood cells, bacteria colonies, drops of liquid or any repetitive event. Tallies up to 9,999. Features a quick reset button and a finger ring for a secure grip. Sturdy, chrome-finish metal construction.

JORS05 **\$13.80/ea** **BUY NOW**

Jorvet Stat Tracker **BUY NOW**

This is a clever device for helping keep track of timed lab tests. The green light illuminates during the start process, at the halfway point the yellow light illuminates, and then the red light for the final alert. Select between six audible alerts. Time displayed on dual-line, 10-digit LCD. Operates on 110AC.

JOR812 Measures 4 1/2" x 4 1/2" x 9 1/4". **\$73.00/ea**

Mortar with Pestle **BUY NOW**

Mortar with spout, outside wall and rim glazed, handle of pestle glazed. Individually boxed. Capacities 30 ml, rim piece 60mm

LPC-154-1 80 ml, volume 80mm rim **\$2.00/ea**

LPC-154 30 ml, volume 60mm rim **\$1.64/ea**

Ceramic Mortar and Pestle **BUY NOW**

The pharmacy aid for crushing tablets into fine powder. Fine quality ceramic mortar and pestle. Smooth surface with pouring lip. 4 oz.

JOR932 4 oz. **\$55.00/ea** **BUY NOW**

Portable Bunsen Burner **BUY NOW**

This portable completely self-contained compact burner features instant ignition for a fast and reliable startup every time. Simply rest your hand on the touch sensitive pad to instantly ignite the burner. Lift your hand from the pad when you're done to extinguish the flame and shut the unit off. The touch activated burner also features a handy dual use locking mechanism that will either lock the flame on, for those longer jobs, or function as a safety lock that prevents accidental ignition. Weighing just 11.2oz. 1 year warranty. Touch Activated Ignition Pad

- Self Contained & Butane Refillable
- Flame Adjustable Dial
- Butane Blue or Yellow Flame
- Safety Lock Prevents Ignition
- Lightweight and Portable - Moves easily between workspaces
- Includes 1 AA Battery
- Approx 65 mins burn time, will vary according to flame length

JOR1046 Sterilizes Instrument **\$139.00/ea**

Veterinary Virology Sampling Kit **BUY NOW**

DISCONTINUED
This kit is designed for collection and transportation of viral cultures. The kit consists of a specially designed flocked sample swab and a 1 ml universal transport medium specific for viral culture. Swab features: Velvet or brush textures of swab end is customized to collect maximum target samples. This swab features a unique molded breakpoint enabling safe, reliable break off and 6" length. Universal Transport Medium Features: Volume 1ml. Safe, shatterproof polypropylene skirted tube with distinctive internal conical shape enabling centrifugation of samples and allowing tubes to stand upright on the laboratory bench. Product can be conveniently stored at room temperature prior to use. Media formulation includes antibiotics to inhibit bacterial and fungal flora in patient samples. Three glass beads in each tube facilitate the release and dispersion of patient sample material and virus particles from the swab during vortexing.

JOR1031 **\$3.40/pk**

Plastic Forceps

97-3901 5", 50 Per Pack **\$5.73/pk**

Centrifuges

Tabletop Centrifuge **BUY NOW**

A truly versatile 6 place bench top centrifuge. Perfect for the office lab or as a backup unit for a busy full service lab. Has an adjustable speed control for spinning urine and speed sensitive sampler a latchable lid and a safety switch.

- 6 place rotor (2-15 ml tubes)
- 30 minute timer
- Speed control (300 - 3,200 rpm)

C816 6-Place rotor \$270.00/ea



Jorvet Portafuge **BUY NOW**

The portable 8-place Porta-fuge is an economical fixed speed centrifuge designed for spinning on the go. This unit accommodates most test tubes from 3ml - 15ml. This unit is virtually maintenance-free and the lid port allows easy viewing and taching of specimens while in use. Simply insert the cigarette plug into your car's power outlet for quick blood separation at 3300rpm.

JORS01P Portable 12v \$295.00/ea



Jorvet Anti-Vibration Mat **BUY NOW**

A special 3M material that is designed to quiet noisy centrifuges or other vibrating instruments. The mat is chemical resistant, easy to clean, and will fit easily under most centrifuge models. The mat is blue.

JORS04X Blue, 14" x 14" \$48.00/ea

JORS04Y Blue, 15" x 18" \$69.00/ea

Mat Only



Jorvet 4 Place Centrifuge Rotor

JORS01SD1 50mm \$510.00/ea

BUY NOW

Microhematocrit Centrifuge

Microhematocrit Centrifuge. This durable centrifuge provides fast results.

Features:

- Tube cover with built-in reader for centrifuge readings and reader card
- Auto off 15 minute timer (on/off switch with indicator light)
- Safety shut-off switch in impact resistant plastic window for safe viewing
- Brush less motor for smooth, quiet operation
- 24 tube (75mm capillary ea.) capacity
- Metal body construction
- Suction cup feet to prevent slipping
- 110V power
- 10.6"W x 8.7"H x 12.5"D; 15.8 lbs.



JORS03M 24-Place rotor \$870.00/ea



Universal Centrifuge **BUY NOW**

A truly affordable 24 place centrifuge with no extra charge for angle head rotor and 24 tube carriers. Features a top speed of 3,500 rpm, a built-in digital display tachometer, brake, speed, 30 minute timer, stainless steel guard bowl and latchable lid with safety interlock switch.

- 24 place
- Rotor (5-15 ml tubes)
- 30 minute timer
- Speed control (300 - 4,200 rpm)

JORS02M 24-Place rotor \$1,612.00/ea

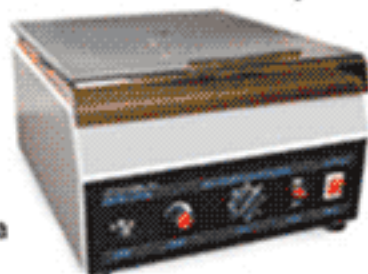

Jorvet Ultra 8 Centrifuge **BUY NOW**

Ultra 8 Centrifuge is nearly indestructible. The one-piece aluminum alloy cast body is stable and strong, and the wide stance eliminates vibration and wobble. The new triangle design saves lab space, and can be easily tucked into a counter corner. The safety shut-off switch is integral in the locking latch, and the clear plastic view port allows for safe observation and speed calibrations. Available ready-to-use, and includes rubber tube cushions to accommodate tubes ranging from 3-15ml. Affordable. Features:

- Routine separation of fluids (i.e., blood and urine)
- 30-minute timer (on/off switch with indicator light)
- Spins up to eight 15ml tubes, 120ml maximum volume
- Impact resistant clear locking lid with safety shut-off switch
- One-piece body with suction cup feet for stability
- Metal rotor housing with smooth, quiet operating brushless motor
- Variable speed: 0-3,300 rpm
- 110V power
- 9"H X 13"W x 13"D. 15 1/2 lbs.
- One-year warranty on materials and workmanship

JORS01U Variable-Speed \$480.00/ea



Test Tube Holders

Only test to holders for this unit.

JORS01MD1 \$19.50/pr

Tissue Floating Bath **BUY NOW**

Low profile 2.3 liter black, finished interior chamber reduces glare, thus improving visibility of the tissue specimen. Glazed glass lid for easy viewing of interior. Top ledge allows space for preheating or for evaporating away any remaining water on the glass slides. Durable fiberglass insulated body prevents heat loss and fluctuations in temperature for uniform surface heating.

Overall Size: 10 1/2" diameter x 8 1/4"

- Interior Size: 8 1/4" diameter x 2 1/2"
- Temperature Range: Room temperature to 75°C

XH-1001 Round Basin, 2.3 liter Black interior chamber \$174.55/ea
10 1/2" diameter x 8 1/4"
Temperature range: room temp to 75 degrees C

Biopsy Cassettes **BUY NOW**

Disposable plastic cassettes holds tissue specimens during embedding, processing, and storage file. Molded from high-density, solvent resistant polymer. Front and sides textured for writing. Two piece construction with lid and base packed separately in same box. 500 cassettes/ box, green

BC-0109G Biopsy Cassettes, 500/bx, plastic, green \$36.60/bx

Centrifuges & Tubes

Centrifuge w/ IRAP and Regular Rotor

Horizontal centrifuges will recover significantly higher numbers of parasite ova than fixed-angle centrifuges or standing fecal flotation procedures. The JORS01sq centrifuge tubes hang vertically while at rest, allowing for the test tubes to be filled completely with a coverslip placed on top of the tube. The tubes then accelerate slowly and swing to a horizontal position while spinning. After completion, simply remove the coverslip and place directly onto a microscope slide. The J-501sq also performs routine urine and semen separations, high-speed blood separations in minutes, and can run microhematocrit samples. New air-piston lid hinges allow the lid to be held at any angle, which means it will fit on nearly all counter tops with low cabinets above.

Features:

- Touch-pad time and speed controls.
- 4-character digital display screen.
- 60 minute programmable timer.
- 800-5,000 rpm programmable speed.
- Rubber feet to prevent slipping.
- Impact-resistant lid with view port.
- One year warranty on materials and workmanship. Dimensions: light 38.2 lbs (17.3kg).
- Includes Crit carriers (J-501c) for microhematocrit tubes (see below).



BUY NOW

JORS01SQ with 4-place IRAP rotor and additional rotor for 15ml tubes, Green color, 100pk \$2,595.00/ea

Centrifuge C-5 w/ IRAP 4 Place Rotor

JORS01SQR with 4-place IRAP **BUY NOW** \$2,440.00/ea

Centrifuge w/ IRAP Rotor, 8-Place & Crit Carrier

JORS01SQIC \$2,690.00/ea

IRAP C-5 Rotor Only

JORS01IR IRAP Rotor only. **BUY NOW** \$840.00/ea

IRAP Ancillary Kit

JOR1081K IRAP Ancillary Kit. Enough ancillary for one IRAP procedure. Contains Jor464 (2), Jor463a (2), Jor1081 (2), Jor174btx (1). **BUY NOW** \$9.00/ea

Universal Cube Test Tube Rack

- 50ml tubes
- 15ml conical tubes
- 1.5ml micro tubes
- 7.5ml blood tubes

JOR878 2 racks/pk. \$18.90/pr

BUY NOW

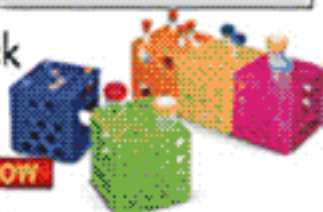

Jorvet Centrifuge Tube

BUY NOW

Conical shaped tube with graduations

JORS46 Reusable Polypropylene Tube, 15ml. Autoclavable and unbreakable, 10/pk, Green Color, 100pk \$4.50

JORS46A Disposable Polystyrene Tube, 15ml, 100/box \$12.60/ea

Microcentrifuge Tubes

BUY NOW

Excellent for serum, urine, or heartworm testing. The 1.5ml tube comes with attached push cap and conical bottom. 10mm (2/5") x 40mm (13/5").

JORS48 1.5ml, 100/pk \$8.70

JORS48A 1.5ml, 500/pk \$39.00



Swing Arm Centrifuge 8-3K **BUY NOW**

Horizontal separation offers many advantages over traditional fixed-angle separations, including tighter straight-line gel separations to reduce re-spins and re-mixes. Additionally, spun fecal floatations in the veterinary markets produce much higher ova recovery results when spun with coverslips on top of the test tube. The Swing-out Select spins 3ml-15ml test tubes, up to 17mm x 128mm, at speeds up to 3,000 rpm. Select either Blood, Urine, or Focals on the speed control, set the 30-minute timer, and the Swing-out Select will spin at the correct speed. The all-metal rotor is built for strength and durability, and the wide mouth bowl allows for easy cleanup. The whisper-quiet, brushless, heavy-duty motor can handle high volume use and high-speed full loads for years to come. Specifications:

- Front-access calibration panel
- Brushless, maintenance-free 110V motor (220V brushed motor available)
- 8 test-tube (3ml-15ml) capacity
- 4-place 50ml rotor available
- Maximum tube size 17.5mm x 133mm
- Includes 3-prong power cord, 8 tube shields, 8 tube cushions (for shorter tubes).
- Dimensions: 12" H (305mm), 18" L (457mm), 14.5" W (368mm). Weight: 33 lbs (15kg)

JORS01SN \$1,035.00/ea



Swing Arm Centrifuge Digital Control 50ml

4 place swing arm centrifuge with 50ml rotor, digital control.

BUY NOW

JORS01ST \$2,199.00/ea

Tube Sleeves for Swing-Arm Centrifuge

JORS01SD2 \$23.00/pk **BUY NOW**

Swing Arm Centrifuge Digital Control

JORS01SO 15ml \$1,990.00/ea **BUY NOW**

Jorvet Crit-Carrier **BUY NOW**

The Crit Carrier is specifically designed to run hematocrits on your Horizontal Centrifuge (minimum 5,000 rpm). Simply insert your hematocrit capillary tubes into the carrier, place the carriers in opposing tube sleeves for a balanced load, and spin at 5,000 rpm for 8 minutes for a clear separation. The Crit Carrier converts the centrifuge into a Hematocrit Centrifuge. Save counter space and the need to purchase an additional hematocrit centrifuge. Spins up to 8 standard 75mm capillary tubes.

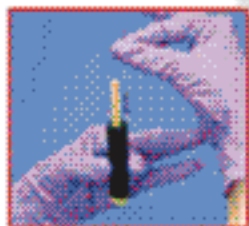

JORS01C \$180.00/pr

Jorvet Conical Centrifuge Tubes

Disposable polypropylene centrifuge tubes are sterilized for critical lab studies. Include polyethylene screw cap with flat top for easy writing or affixing labels. The tubes have bold, easy-to-read white graduations and a large writing area.

JORS46B w/Screw Cap 15ml, 100/bag \$22.50 **BUY NOW**

JORS46D w/Screw Cap 50ml, 100/bag \$42.00

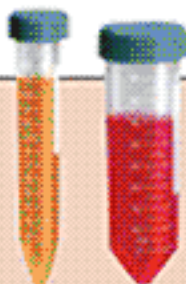

Jorvet Large 50ml Wire Tube Rack

Epoxy-coated wire rack that holds 50ml tubes. Tubes not included.

BUY NOW

JOR879 Single 50ml Tube Rack, Interlocking, 3" x 2 3/4" high. \$13.50/ea

JOR879A 50ml Tube Rack, Holds eight 50ml Tubes, 5 3/4" x 3" x 3 3/4" high. \$36.60/ea

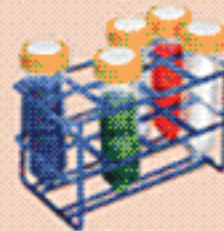



Jorvet Personal Eyewash Station

Mount on wall to provide immediate relief. This station holds two 32 oz. dosing bottles for thorough decontamination of face and eyes. Comfortable molded eye socket opening allows full flow of solution to completely irrigate affected eye. Imprinted emergency use instructions are on each bottle and station wall. Bottles are shipped empty to fill with water or saline depending on local regulations. Securely mount station with top and bottom holes (hardware included).



JOR989 17" W x 4" D x 14 1/2" H. \$144.00/ea **BUY NOW**

Uterine Cytology Brush

The use of a cytology brush is very common in female human patients. This cytology brush is a standard human cytology brush that is adhered to a culture swab insertion rod. It has the same double-guarded configuration as the JOR273.

JOR273C 10/box. \$105.00/pk



BUY NOW



Jorvet Spray Wash Bottle

These wash bottles have a fine needle stream.

JOR818A 16 oz. Polyethylene material \$12.30/ea
 JOR818 8 oz. Polyethylene material \$12.90/ea



BUY NOW

Tieglund Modified Culture Swab

The original uterine culture swab. Swab is covered with outer flexible plastic tube. After the culture is taken, a scored ring 3 1/2" from the end allows the tube to snap off and is plugged with two included plastic caps. This allows for ease of transport and storage.

JOR274 33"L. 25/box. \$109.50/pk



BUY NOW

Jorvet Safety Labeled Wash Bottles

Ensure leak proof dispensing of your common lab solutions. Polypropylene closure is 53mm W with a leak proof design. Easy-to-read and color-coded for content recognition and informative safety labeling:

- Printed bottle: Dept of Transportation (DOT)
- National fire protection (NFPA) codes and symbols
- Chemical abstract service number (CAS)
- Protective equipment symbols and target organ information All this information makes your workplace safer.

JOR817 Complete set of 8 labeled wash bottles 500ml (16 oz) Bottle. \$81.00/ea
 JOR817A Deionized water labeled wash bottle 500ml (16 oz) \$10.35/ea
 JOR817B Distilled water labeled wash bottle 500ml (16 oz) \$10.35/ea

JOR817C Saline solution labeled wash bottle 500ml (16 oz) \$10.35/ea
 JOR817D Sodium hypochlorite (bleach) wash bottle 500ml (16 oz) \$10.35/ea
 JOR817E Soap labeled wash bottle 500ml (16 oz) \$10.35/ea
 JOR817F Ethanol labeled wash bottle 500ml \$10.35/ea
 JOR817G LYOB wash bottle 500ml (16 oz) \$10.35/ea
 JOR817H Isopropanol labeled wash bottle 500ml (16 oz) \$10.35/ea
 JOR817K Distilled water labeled wash bottle 1,000ml (32 oz) \$12.60/ea
 JOR817M Isopropanol labeled wash bottle 1,000ml (32 oz) \$12.60/ea
 JOR817Q Ethanol labeled wash bottle 1,000ml (32 oz) \$12.60/ea
 JOR817R LYOB wash bottle 1,000ml (32 oz) \$12.60/ea
 JOR817S Complete set of 4 labeled wash bottles 1,000ml (32 oz) \$49.50/ea



Swabs

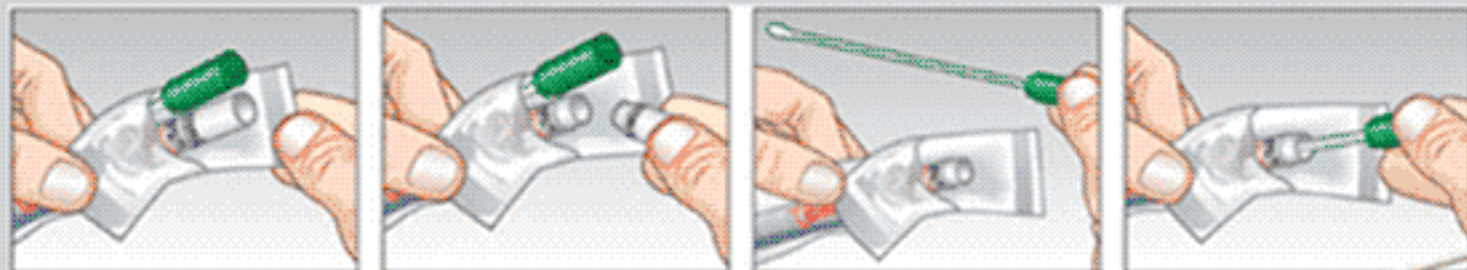

Agar Gel Transport Swab

Veterinarians often encounter challenging infectious cases that require a bacterial culture and antibiotic sensitivity. A quality transport swab will preserve the specimen from the patient to the laboratory, whether the lab is in the next room or in the next state. Individually wrapped, 50/carton. Features:

- Extra-long 5 1/4" swab shafts enable easier access to difficult sites without contamination
- Soft rayon swab tips are inert and non-toxic to micro-organisms and patients
- Tamper evident tube seal
- Large pre-attached label
- Non-breakable polypropylene tube with hour glass design squeezes out undesirable air harmful to fastidious bacteria, and prevents disintegration of gel column during transportation
- 5ml deep agar gel column insures maximum protection, improves sample viability, and optimizes moisture control



BUY NOW

JOR867A	Amies Agar Gel with Charcoal Transport Swab, 50/carton	\$48.00/ea
JOR867T	Stuart's Liquid Media w/foam sponge, 50/carton	\$45.75
JOR867	Most popular. 50/carton	\$45.75/pk

Jorvet Double Guarded Culture Swab

This swab is protected by two outer plastic sheaths and a cap. The outer sheath and cap are penetrated after the swab passes the cervix into the uterus. The swab is scored so its length can be reduced and then covered with the two included caps for storage or transport.

JOR273 33"L, 25/box. \$101.00/pk



BUY NOW

JorVet



Jorvet Guttural Pouch Culture Swab

Getting a culture or cytology sample from the equine guttural pouch is a real challenge. The conventional swabs do not have the proper angulation for entry into the guttural pouch. This 22" culture swab is bent to about a 30° angle. After the sample is obtained, it can be removed with the outer sheath still in the guttural pouch. Then medication can be infused if found necessary. The swab is covered by a methylcellulose plug prior to entry and to avoid contamination. 5/pk. (not pictured)

JOR726G 5pk \$66.00/pk

Jorvet Culture Swabs

BUY NOW

JorVet

Getting a culture or cytology sample from the equine guttural pouch is a real challenge. The conventional swabs do not have the proper angulation for entry into the guttural pouch. This 22" culture swab is bent to about a 30° angle. After the sample is obtained, it can be removed with the outer sheath still in the guttural pouch. Then medication can be infused if found necessary. The swab is covered by a methylcellulose plug prior to entry and to avoid contamination. 5/pk. (not pictured)

JOR726	2.0mm x 100cm, 5/pk. (not pictured)	\$13.80/ea
JOR726A	2.0mm x 140cm	\$17.10/ea
JOR726B	2.6mm x 140cm	\$15.90/ea
JOR726D	2.6mm x 250cm	\$24.00/ea
JOR726C	2.6mm x 170cm	\$12.00/ea

Cytology Swabs

BUY NOW

JorVet

JOR725B	2.6mm x 140cm	\$16.80/ea
JOR725C	2.6mm x 170cm	\$18.60/ea
JOR725D	2.6mm x 250cm	\$24.00/ea
JOR725	2.0mm x 100cm	\$14.70/ea



Jorvet Guarded Culture Swab

The most popular style of culture swab. A hinged guard or cap covers the tipped swab. This bullet-shaped tip allows easier insertion and protects the swab from contaminants. 28"L flexible rod compares in style to Kalayjian™ brand culture swabs.

JOR272 25/box. \$118.00/pk

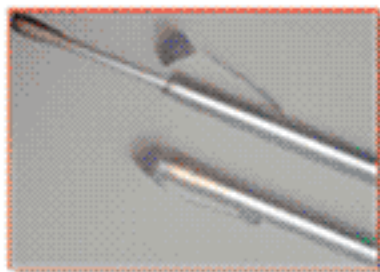

JorVet

Inoculation Loops

Double-ended inoculation loop. One end has a 10ul size loop the other end a smaller 1ul loop, disposable individually wrapped and sterile. 50/pk Polystyrene

JOR549A Sterile, 50 \$13.50/ea

BUY NOW

Inoculating Loop with Handle

Inoculating loops are a necessary part of doing any sort of bacterial culturing. These Nichrome wire loops are attached to an anodized aluminum handle. The wire loops are durable plus rapidly cool following heat or flame sterilization. The loop is a 3mm diameter or 26g wire. Each.

JOR549C \$11.40/ea/ea

BUY NOW

JorVet

JorVet

Fecal Testing, Capillary Tubes & Insemination Kit

Fecatector Diagnostic Kit

A unique, sanitary leak-proof collection device, to be used by the client for obtaining fecal samples from pets. The same container then doubles as the laboratory flotation device. This eliminates the need for technicians to transfer or contact the stool sample. Comes complete with laboratory instructions card and easy-to-follow client instruction sheets. Comes in a compact display box for wall-mounted or counter use.

606-2799 50 kits per box \$17.99/bx



Hydrometer for Fecal Flotation Solutions

This hydrometer is perfect for testing fecal flotation solutions in the narrow specific gravity range of 1.18 to 1.25. The best results for detection of parasitic ova are using solutions in the S.G. range. This hydrometer is the best and easiest way to confirm you are using the right solution. 6" long glass suggest clear round graduated cylinder (JOR281d2) for holding and floating hydrometer.

JORS01H Gravity Range of 1.18 to 1.25 \$46.00/ea

Sheather's Sugar Flotation Solution

Find more eggs!! Recent studies have proven that centrifugation of fecal samples is for more effective than traditional standing passive flotation. Furthermore, a flotation media must have a higher specific gravity than 1.20 to float many of the common parasite ova. Sheather's sugar solution has a specific gravity of 1.27 which is high enough to float any ova. Basic Physics: If an ova has a higher specific gravity than the flotation solution, it will not float nor will it be detected.

JOR1028 500ml bottle \$8.40/ea
 JOR1028G Gallon Size Bottle \$22.80/ea

Dermatophyte Test Medium

RXDTM-CULTURE 10 cultures/box

\$23.25/bx

Zinc Sulfate Fecal Flotation Medium

RXZVA-GAL Sodium Nitrate, gallon

\$16.29/gl

Optical Lens Paper

Non-scratch optical lens paper suitable for cleaning cameras, microscopes, and other optical instruments.

MA02 4x6", 100 sheets/pack, 12 pack/box \$13.44/bx

"No-Residue" Microscope Lens Cleaning Solution

1 oz. dispensing bottle. Removes dried residue from objectives.

JOR869S Use with JOR869 lens tissues. \$12.00/ea

Capillary Sealant Tray

Leak-tight sealant formed quickly from unique compound designed to withstand centrifugation. Non-toxic, non-drying, non-hardening.

JORS45 Tip resistant tray for upright storage of 24 tubes. \$6.90/ea

Microhematocrit Capillary Tubes

These capillary tubes are designed for both safe blood collection as well as an accurate microhematocrit determination. Precision molded, they provide excellent sample retention during centrifugation. Tubes fill rapidly without affecting specimen integrity. Tube 1.15mm i.d. x 1.55mm o.d. 75mm length. Packaged in a protective snap cap vial. 100 tubes/vial/10 vials/cs

JORS42 100-pack, 10 pk/case \$52.50/cs
 JORS43 Red Tip, Heparinized Tube, 100/vial \$34.50/cs
 JORS44 Blue tip plain microhematocrit tubes \$30.90/cs

Standard 75mm Microhematocrit Tube

Wrapped with three layers of Mylar. Hemato-clad hematocrit tubes combine the precision of glass with the safety provided by a mylar over wrap. Accidental breakage is significantly reduced particularly when pressing into sealing clay. In the event of breakage, the Mylar wrapping will help contain the blood sample and provides an added layer of protection against cuts from broken glass. Handy dispensing vial with chrome lid.

JORS43M Blue Tip, Plain tube \$95.00/cs
 JORS44M \$94.00/pk

Plastic Forceps

97-3901 5", 50 Per Pack \$5.73/pk

JorVet Small Animal Artificial Insemination Kit

A complete kit for the veterinarian for the collection of semen and insemination of the female.

- Includes:
- Latex collection cone
 - Four vaginal pipettes
 - 12cc syringe
 - Small plastic cap for end of syringe
 - Cone holder
 - Direction sheet
 - JORJelly Lubricating gel, 8 oz. flask

JOR102 Complete Kit \$30.90/ea

Formalin-Filled Container

Biopsy and tissue samples need to be handled properly for the best results. These clear polystyrene containers are pre filled with 10 percent phosphate buffered formalin. The screw caps are lined polyethylene that are leak tight and grooved for secure handling. In accordance with OSHA requirements, the containers are affixed with warning labels containing sufficient space for writing patient's name, specimen description, and the veterinarian's name.

JORS52 15ml, 10 pk \$7.80/pk
 JORS52A 30ml \$9.30/pk
 JORS52B 60ml \$15.30/pk
 JORS52C 120ml \$15.30/pk

X-Ray Products

X-Ray Illuminators & Cassette Accessories



Jorvet Slimlite X-ray Illuminator

BUY NOW



High quality radiographs should be matched with a high quality viewing box for the maximum diagnostic image. The Jorvet Slim Lite viewing box uses new "Edgelite" technology with proprietary light diffusion material giving an almost sunlight illumination with 5,000° Kelvin color temperature. In addition, this "Edgelite" format allows a much thinner or streamlined attractive profile than other viewing boxes.

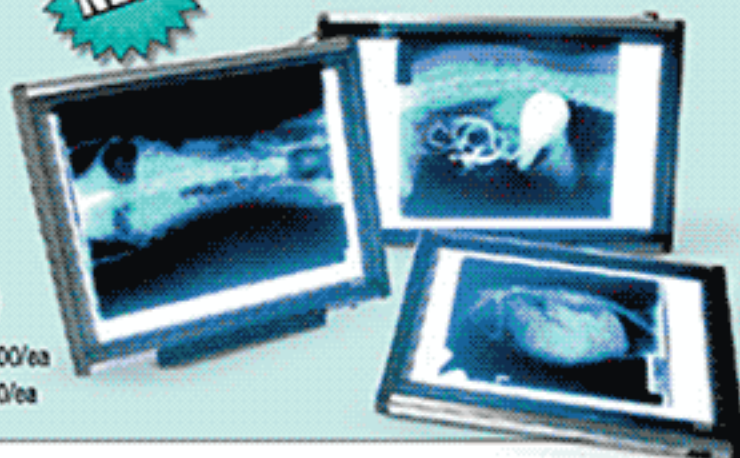

JOR806A	12" x 18"	\$346.00/ea
JOR806B	14" x 18"	\$426.00/ea
JOR806C	14" x 24"	\$530.00/ea

Slimlite X-ray illuminator (Accessories)

JOR806D	4 Amp Battery Pack for X-ray Illuminator	\$123.00/ea
JOR806S	Desk Stand for Portable Slimlite	\$52.00/ea

X-Ray Illuminator

BUY NOW

Superior quality plexiglass front. Desktop or wall mount. 110 volts.

ILLDOUBLE	Double Bank 28" X 17"	\$239.00/ea
ILLSINGLE	Single Bank 14" X 17"	\$125.00/ea

X-Ray Illuminator Bulb

Replacement bulb for x-ray illuminator.

ILL-BULB	Bulb, ea	\$18.00/ea
----------	----------	------------



Single Bank X-ray Illuminator

Single bank constructed of all steel. High luster white powder coat. One piece plexiglass panel with 14" x 17" viewing area. Three-bulb configuration. Roller gravity grips.

JOR806Y	110V AC Power.	\$150.00/ea
---------	----------------	-------------



BUY NOW

Double Bank X-ray Illuminator

Two 14" x 17" viewing areas. Individual on/off switch, 5 bulb configuration.

JOR806Z	32"(w)x 23"(h)x 41"(d)	\$218.00/ea
---------	------------------------	-------------

BUY NOW

Equine X-ray Cassette Holder

BUY NOW

A lightweight piece of equipment that allows the cassette to be held at any angle but keeps the person holding it out of the harmful X-ray beam. Will hold both 8" x 10" and 10" x 12" cassettes. 36" shaft. Quick release clamp. Breakdown model for easy storage.

JOR296	12"W x 42"L. 2 lbs.	\$150.00/ea
--------	---------------------	-------------



Sterile X-ray Cassette Cover

JOR882	for 8" x 10" & 10" x 12"	\$6.00/pr
--------	--------------------------	-----------

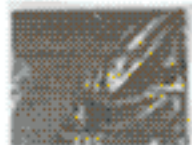

Jorvet Slimlite X-ray Illuminator (Accessories)

JOR806D	4 amp Battery Pack for X-ray illuminator	\$123.00/ea
JOR806S	Desk Stand for Portable Slimlite	\$52.00/ea

BUY NOW

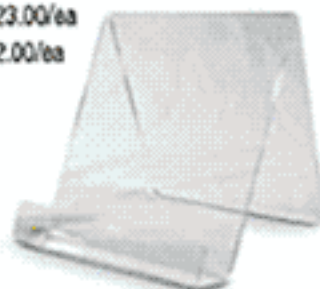

Magna Arm Magnifier for X-ray Illuminators

Allows the user to magnify 4x the details of X-Ray film. It is attached to a fully articulated locking arm that holds the 2" dia. half-sphere magnifier in place for hands-free magnification.

JOR806M	Small Illuminators	\$195.00/ea
JOR806MA	Large Illuminators	\$205.00/ea
JOR806MP	Portable Illuminators	\$166.00/ea



BUY NOW

Crystal View with Wood Base

JOR806X	2 1/2"	\$40.50/ea
---------	--------	------------

BUY NOW

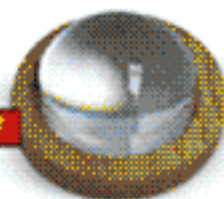

Nylon Padded Carry Case for X-ray Illuminator

JOR806P	\$74.00/ea
---------	------------

BUY NOW



Jorvet X Ray Markers W/ Graduations

This set of two x-ray markers (L and R) does more than give the side orientation of an x-ray. It has a cm scale that provides measurements. This is useful at sending digital x-rays to other parties that may have a different software or type of digital radiography. The markers are 50mm long and marked in 5mm intervals. Set of 2.

JOR1185	set of 2, left and right	\$12.00/pr
---------	--------------------------	------------

BUY NOW

X-Ray Products

Stands, Positioners, Laser Pointer & Cassette Accessories



Jorvet Quick Shot X-ray Cassette

This handy device holds the cassette at arm's length directly attached to the portable x-ray unit. The "Quick Shot" allows a single person to take films and eliminates the need for assistance. Lightweight aluminum weighs only 2 1/2 lbs. Adjustable handle allows usage with all commercial portable x-ray units. Holds wide range of cassette and grid sizes. No guess work in achieving proper focal lengths. "Bubble" level mounted on top of the handle and side of the cassette holder. Adjustment knobs allow positioning of cassettes at all angles. Folds flat for easy storage. Foam padded handle has holder for x-ray machine trigger. Removes many positioning variables.

JOR493X X-ray Machine not included \$424.00/ea

BUY NOW



Jorvet Redden Navicular Stand

Getting consistent and repeatable navicular views is one of the toughest equine X-ray challenges. This design aligns all 3 factors—the machine, the hoof, and the cassette. Spacer bar holds X-ray machine at correct focal length. Outstanding evaluation of navicular bone is possible through a 45° oblique view. Stand is made of cast aluminum. Stand will pay for itself the first two times you do not have to retake navicular views.



Jorvet

BUY NOW

JOR495R Navicular Stand Only \$166.50/ea
 JOR495R With X-ray machine holder. Designed for the mini-X-ray unit. \$260.00/ea

Jorvet Equiprax X-ray Positioner

Clinical field situations often result in varying angles, distance, and exposure. Lesions (particularly on the navicular bone and the 3rd phalanx) can be obscured or eliminated by variations in the radiographic position. The Equiprax Radiograph Positioner was designed by an equine practitioner to give consistent quality diagnostic radiographs. Allows for five different views.

JOR275 \$198.00/ea

Jorvet



BUY NOW

Dual Laser Pointer for X-ray Units Holder

Standard collimator white light is difficult to see in outdoor sunlight or even indoor light. This makes achieving the proper focal distance difficult. This small dual pointer mounts on a portable x-ray unit. The twin beams cross at the preferred 26" film focal distance and can be seen in any lighting situation. Uses standard watch batteries.

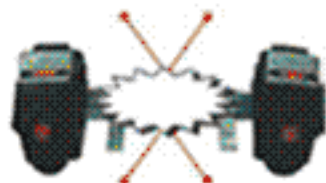

JOR493W Uses standard watch batteries. \$282.00/ea

BUY NOW

Jorvet Radiograph Cassette Tunnel

Navicular and skyline shots are easy with this cassette tunnel plus it protects your delicate cassettes. Lightweight shatter resistant polycarbonate top with solid oak frame. Bottom is lined with lead to prevent back scatter. Holds 8" x 10" standard cassettes. Has a toe grab to hold hoof in place. Tilting support base allow any angle change or upright shots. Non-slip surface. Carrying handle.

JOR494MA Uses standard watch batteries. \$245.00/ea
 JOR494M Uses standard watch batteries. \$238.00/ea



BUY NOW

X-Ray Density Filter

BUY NOW

Available in white, green and yellow. Please indicate color at time of order. Prices on x-ray density filters are subject to change without notice. Please contact one of our friendly customer service representatives for current pricing.

DF-P	Plain	\$26.07/ea
DF-RL	RLt	\$36.78/ea
DF-DVND	DvNd	\$36.78/ea



Your Name OVM _____ DV
 CHICAGO, IL _____ VO

Tomahawk X-ray Cassette Holder

This hand held positioner safely holds 8x10", 10x12", and 14x 17" cassettes for a wide range of views and maintains safety by avoiding exposure to the x-ray beam. Features: Lightweight aluminum weighs 2 1/2 lbs. Spring loaded clamp holds full range of cassettes sizes with easy changing. Rotating grip handle telescopes in length. 2 handles provided. Long handle 32"-54" Short handle 0"-20". Has non slip black plastic grip. Center ground support leg also telescopes from 0-20" in height. "Bubble" level on top helps give accurate position. Folds up for easy storage in mobile vet units.

JOR492M \$355.00/ea

BUY NOW



Jorvet X-ray Cassette

Jorvet

JOR650 w/Medium Speed Screen, 8" x 10" \$90.00/ea

13822 WEST BOULTON BLVD. METTAWA, IL 60045

WWW.SHOPMEDVET.COM

Phone 800-544-7521

328

Fax 800-204-2177



Aprons, Gloves & Miscellaneous X-Ray Supplies

X-Ray Aprons

Our quick-release belt buckle system is easy to use and helps transfer the weight of the apron from the shoulders to the waist. The nylon exterior is easy to clean, yet flexible enough for hassle-free movement. 0.5mm pb equivalent

60895 .5mm Protection \$200.00/ea

BUY NOW



X-Ray Apron w/ Velcro Tie

Features two hook and loop (Velcro) flaps at the waist which aid in relieving weight off of the shoulder. Its comfortable fit is attained by varying the position of the flaps. **Gloves Sold Separately**

JOR676WA	Royal Blue with White Paws, Small, 34" length	\$149.00/ea
JOR676WB	Royal Blue with White Paws, Large, 38" Length	\$149.00/ea
JOR676WC	Brown w/Black Paws, Small, 34" Length	\$178.00/ea
JOR676WCL	Brown w/Black Paws, Small, 38" Length	\$178.00/ea
JOR676WD	Wild Cat Pink, Small, 34" Length	\$178.00/ea
JOR676WDL	Wild Cat Pink, Large, 38" Length	\$178.00/ea
JOR676WE	Tiki Blue, Small, 34" Length	\$178.00/ea
JOR676WEL	Tiki Blue, Large, 38" Length	\$178.00/ea
JOR676WF	Red Flame, Small, 34" Length	\$178.00/ea
JOR676WFL	Red Flame, Large, 38" Length	\$178.00/ea
JOR676WG	Hot Pink Plaid, Small, 34" Length	\$178.00/ea
JOR676WGL	Hot Pink Plaid, Large, 38" Length	\$178.00/ea

X-Ray Thyroid Cover

Our Thyroid Collar is exceptionally pliable and comfortable to wear. It provides 0.5 mm lead protective equivalency.

63421 .5mm Protection \$70.36/ea

BUY NOW

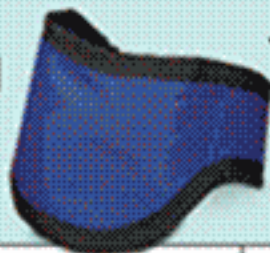

X-Ray Gloves

Particularly ideal for the emergency room area, these molded lead gloves take advantage of new technology to provide increased dexterity. Special surface sealant eliminates the need for an outside cover.

69358 Small \$193.00/pr
69359 Medium \$193.00/pr
69360 Large \$193.00/pr



FOR SALE

BUY NOW

X-Ray Mittens

This 0.5mm vinyl covered mitten is a standard size 9. Perfect for general department or veterinary use.

69550 .5mm Protection \$145.00/pr



FOR SALE

BUY NOW

Slit Mitt X-Ray Gloves

Finger slits for complete finger movement as well as total hand protection. Provides 0.5mm Pb protection. Manufactured with soft lead for superior flexibility. Blue nylon reinforced vinyl for strength and ease of cleaning.

SM-100T pair \$135.00/pr

BUY NOW



X-Ray Protective Gloves

JOR677X Seamless lead vinyl gloves are a 15" one piece dip molded glove with supple vinyl cover and foam liner. Burgundy color. Standard protection 0.5mm Pb equivalency

BUY NOW \$188.00/pr



X-Ray Label Tape

X-ray labels protect your patients and your practice with reliable, permanent x-ray identification

75-02C 3/4" X 2" 100/bx \$18.00/bx
75-03C 3/4" X 3" 100/bx \$30.06/bx
75-25R 3/4" X 25' 1 Roll \$24.50/rl



BUY NOW

X-Ray Developing Hanger

Stainless steel metal hanger holds the x-ray film while in the developing or processing tanks. Clip on to the four corners of the film.

BUY NOW

JOR678 8" X 10" \$27.00/ea
JOR678A 10" X 12" \$27.00/ea
JOR678B 14" X 17" \$27.00/ea

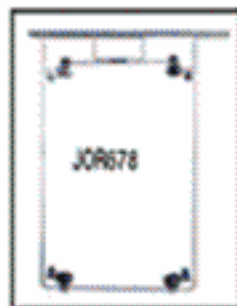

X-ray Measuring Caliper

Getting the correct thickness of your patient is critical to proper KVP setting and quality diagnostic radiographs. Measurements in centimeters only. Stainless steel.

JOR684 Stainless steel \$30.00/ea

JOR684

BUY NOW



FREE AMEX GIFT CARD
WITH YOUR QUALIFYING PURCHASE SEE INSIDE COVER FOR DETAILS

Canine & Feline Models

Canine Lumbar Model

Vertebral column of average size dog features 5 lumbar vertebrae and discs, caudal (tail) vertebrae and sacrum

- Model Size: 8" x 2" x 2"
- Card Size: 6-1/2" x 5-1/4"
- Base Size: 6-1/2" x 5" x 1"

G1080 8" x 2" x 2" \$87.70/ea



BUY NOW

Canine Knee Model

Average size dog knee with femur, fibula, patella and tibia bones, lateral and medial meniscus, anterior and posterior cruciate ligaments, plus 6 more ligaments and tendons.

- Model Size: 2" x 3-1/2" x 7"
- Card Size: 5-1/4" x 6-1/2"
- Base Size: 6-1/2" x 5" x 1"

G1050 2" x 3-1/2" x 7" \$91.50/ea



BUY NOW

Canine Ear Model

This 2-sided, average size, canine ear depicts: a normal side with cochlea, auditory tube, tympanic bulla, middle ear cavity, tympanic membrane, horizontal canal, vertical canal, auricular cartilage, pinna and temporalis muscle. The diseased side illustrates: inflamed inner ear structures, inflammatory exudate in tympanic bulla, ear canal with partial occlusion from cellular hyperplasia, inflammatory exudate and an inflamed outer ear.

- Model Size: 4.75" x 2.75" x 2"
- Card Size: 5-1/4" x 6-1/2"

G1200 4.75" x 2.75" x 2" \$79.80/ea



BUY NOW

Heartworm Disease Model

Cut-away view of an average size dog heart with improved decoration of arteries, fat & 3 sections of heartworm parasites.

- Model Size: 3" x 3-1/2" x 4-1/4"
- Card Size: 6-1/2" x 5-1/4"
- Base Size: 6-1/2" x 5" x 1"

G1150 3" x 3-1/2" x 4-1/4" \$77.60/ea



BUY NOW

Ear Model

Otic exams are a common daily practice for veterinarians. However, the client never sees what the veterinarian sees. This cut-away model outlines the normal anatomy of the ear plus associated nearby structures. It also illustrates common ear disease like otitis externa, polyps and even has a fox tail. The pinna shows a hematoma and a fly strike. Accompanied with a laminated color explanatory chart. Hand painted in beautiful colors.

J0R772 3 1/2"W x 6"H x 2"D. \$76.00/ea



BUY NOW

Feline Skeletal Model

Model of the skeleton of a cat features a removable tail and skull with jaw on springs. Mounted on Base.

CHC1 16"L x 9" H \$149.95/ea

BUY NOW

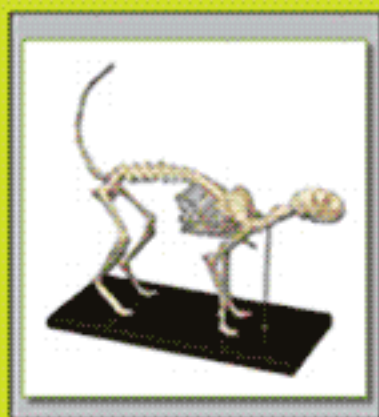

Canine Hip Model

Average size dog pelvis that features both normal and osteoarthritic bone, body of ilium, greater trochanter, head in acetabulum, herniated disk, neck of femur, nerve, sacrum, and third trochanter.

- Model Size: 7" x 5-1/2" x 11"
- Card Size: 8-1/4" x 6-1/4"
- Base Size: 6-1/2" x 5" x 1"

G1060 7" x 5-1/2" x 11" \$117.90/ea

BUY NOW



Canine Skeleton Model

Skeleton of an average-sized dog with removable tail and skull with jaw on springs. Mounted on base.

CHD1 21" x 12" \$159.95/ea

BUY NOW

Also Available

CHD2L Large \$180.00/ea



Canine & Feline Models

Canine Elbow Model

Healthy left elbow of average size dog includes: humerus, radius and ulna bones; plus 6 ligaments.

- Model Size: 9-1/2" x 1-3/4" x 7-1/2"
- Card Size: 6-1/4" x 8-1/4"
- Base Size: 6-1/2" x 5" x 1"

G1070 9-1/2" x 1-3/4" x 7-1/2" \$85.10/ea



BUY NOW

Canine Shoulder Model

Average size dog shoulder with scapula, humerus, biceps brachii tendon, coracobrachialis tendon, lateral glenohumeral ligament, medial glenohumeral ligament and transverse humeral ligament.

- Model Size: 11-1/8" x 3" x 2"
- Card Size: 6-1/4" x 8-1/4"
- Base Size: 6-1/2" x 5" x 1"

G1075 11-1/8" x 3" x 2" \$89.20/ea



BUY NOW

Canine Hip/Lower Back Model

- One hip joint features normal anatomy, the other shows pathology. (i.e., hip dysplasia)
- Normal and abnormal inter-vertebral discs
- Spinal cord and nerve roots are in yellow
- Lumbosacral joint

JOR775 Wood base 7" x 9" \$118.00/ea

BUY NOW



Heart Model

Heart Model with adult heartworms. This two-piece model offers a dramatic representation of what a heartworm infection can look like. Accompanied with a laminated color-explanatory chart. Hand painted in beautiful colors.

JOR773 \$82.00/ea



BUY NOW

Canine Jaw Clear Model

Healthy canine hinged jaw showing the roots of all teeth (incisors, canine, premolars, molars). Can be separated for better observation.

Model Size: 4-3/4" x 2-3/4" x 2"
Card Size: 6-1/2" x 5-1/4"

BUY NOW

G1196 4-3/4" x 2-3/4" x 2" \$94.50/ea

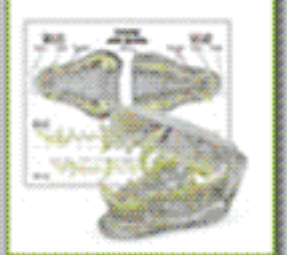

Canine Jaw Model

Average size canine jaw depicts healthy teeth on the right side and diseased/damaged teeth on the left. The nine pathologies featured are: fractured canine, periodontal disease, tartar accumulation, plaque, gingivitis, worn incisors, retained deciduous tooth, gingival recession and missing premolar. The jaw may be opened, closed and separated for closer study.

Model Size: 4.75" x 2.75" x 2"
Card Size: 6-1/2" x 5-1/4"

BUY NOW

ADM-1 Canine 4.75" x 2.75" x 2" \$128.00/ea
ADM-2 Feline 2.75" x 2" x 1.125" \$118.00/ea



Feline Jaw Clear Model

G9191 \$88.30/ea Not Pictured

Dental Model (Clear)

Beautiful clear acrylic models are great demonstration tools for clients. The entire dental arcade is shown in anatomically correct presentation. The shape of roots can be seen. Teeth are natural color.

JOR770D Canine \$324.00/ea
JOR770F Feline \$268.00/ea
JOR7700F Set of clear dental models \$540.00/ea
(JOR770D & JOR770F)
Canine and Feline

BUY NOW



Pathology Dental Model

BUY NOW

These realistic models are all in natural colors of gum tissue and teeth. One side shows examples of over 20 common dental problems, the other side shows normal anatomy. Accompanied with a laminated color chart identifying all pathologies.

JOR771S Set of 2 Canine & Feline Models \$180.00/ea
JOR771 Canine Model \$101.00/ea
JOR771C Feline Model \$128.00/ea



Canine Stifle Model

Canine Stifle. Shows all ligaments and related structures like the meniscus. Only normal structures are shown.

JOR776 Wooden base 4 1/2" x 6". \$89.00/ea

JorVet





Veterinary Anatomical Charts

Produced by Anatomical Chart Company, these scientific and medical illustrations are designed in consultation with veterinarians and zoologists to develop charts illustrating the anatomy, systems, structures, diseases and conditions of selected domestic animals. The first installment in this new line of veterinary charts are the Skeletal Anatomy of the Horse, the Cat and the Dog. A detailed illustration of the animal and its skeletal system is the focus of each chart. Details of the skeletal system and specific diseases are also illustrated. Each chart measures 26" by 20" and is printed on high quality heavy paper. All charts are available in paper, flexible lamination and rigid lamination.

Canine Muscular Anatomy Chart (A)

8704-PL1.5 26"x 20", Flexible \$22.95/ea
 8704-PL 26"x 20", Rigid \$33.95/ea **BUY NOW**

Canine Skeletal Anatomy Chart (B)

8703-PL1.5 26"x 20", Flexible \$22.95/ea

Canine Internal Anatomy Chart (C)

8705-PL1.5 26"x 20", Flexible \$22.95/ea **BUY NOW**

Feline Skeletal Anatomy Chart (D)

8702-PL1.5 26"x 20", Flexible \$22.95/ea **BUY NOW**

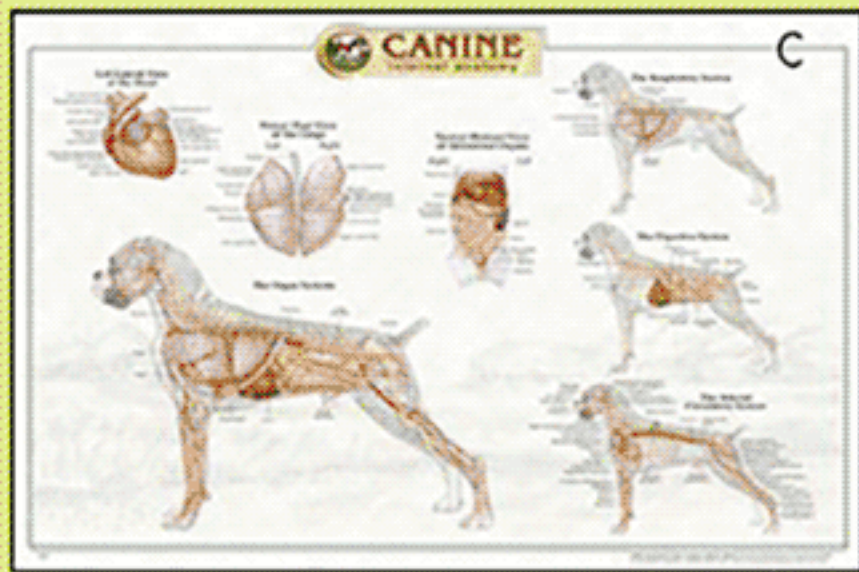

Medical Charts

Equine Charts

Produced by Anatomical Chart Company, these scientific and medical illustrations are designed in consultation with veterinarians and zoologists to develop charts illustrating the anatomy, systems, structures, diseases and conditions of selected domestic animals.

A detailed illustration of the animal and its skeletal system and specific diseases are also illustrated. Each chart measures 26" by 20" and is printed on high quality heavy paper and has a flexible lamination applied. **BUY NOW**

EQ-01	Conformation	\$22.95/ea
EQ-02	Dental	\$22.95/ea
EQ-03	Digestive	\$22.95/ea
EQ-04	Foaling	\$19.95/ea
EQ-05	Foot & Hoof	\$22.95/ea
EQ-06	Forelimb Joint	\$22.95/ea
EQ-08	Hindlimb Joint	\$22.95/ea
EQ-11	Neurological	\$19.95/ea
EQ-13	Anatomy/Vital Signs	\$22.95/ea

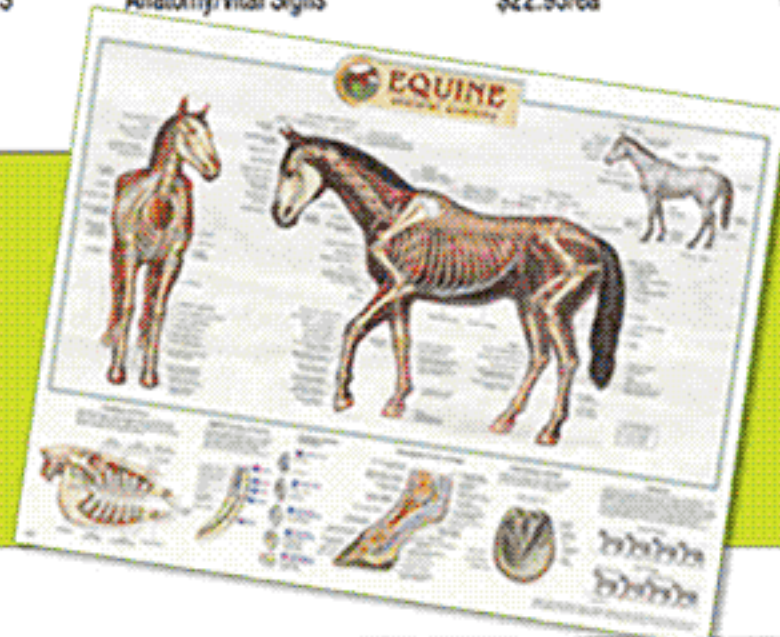

Equine Skeletal Anatomy Chart

Produced by Anatomical Chart Company, these scientific and medical illustrations are designed in consultation with veterinarians and zoologists to develop charts illustrating the anatomy, systems, structures, diseases and conditions of a horse. Each chart measures 26" by 20" and is printed on high quality heavy paper with your choice of flexible lamination and rigid lamination.

8701-PL1.5 26"x 20", Flexible \$22.95/ea

Ivermectin Paste

RXIVER-PAST 1.87%, 6.08gm \$3.70/ea **BUY NOW**



Flea Life-Cycle Model

JOR777 \$45.95/ea **BUY NOW**



Cryosurgery in Horses handbook

JOR811M Cryosurgery in Horses handbook \$30.00/ea

BUY NOW

Chondrogen EQ

RXCHON-EQ-75 150 dose powder, 75oz

BUY NOW

\$135.00/ea



Pharmaceutical Prices Subject Change Please Call before ordering

Pill Splitter, Bottle Closures & Culture Tubes

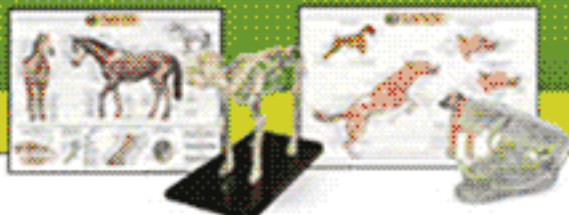

Pill Splitter

BUY NOW

Many tablets or pills are too large for smaller veterinary patients. There is a need to precisely split pills for accurate dosing. This pill splitter has a thin razor-sharp blade that cuts the pill cleanly. The "V"-shaped trough holds a variety of pill sizes. Lightweight blue plastic can be easily cleaned.

JOR696 \$5.80/ea



DELUXE Pill Splitter

- An improved pill splitter for more precise and cleaner cuts. Additionally, larger nonstandardized pills fit.
- Flexible arms and cutting base with soft rubber material that holds pills more securely in place
- See through design assists user to visually align pill prior to splitting
- Molded polycarbonate with double-beveled German-made steel blade



JOR660 \$12.75/ea

BUY NOW

Pill Splitter/Crusher

This handy device will either split or crush a tablet. Has a storage case on the bottom.

JOR698 Blue \$16.80/ea



BUY NOW

Jorvet AI Pipettes

BUY NOW

JOR10202	Small Animal, 6", 4pk	\$2.10/pk
JOR10202A	Small Animal, 25pk	\$6.50/pk
JOR10203	Long Canine, 9" 9". With blue syringe adapter. Pack of 12. Nonsterile.	\$4.50/dz

BULL Semen Collection Cones

BUY NOW

JOR10201 All Latex Cone, X-Large size. \$15.30/ea

Cage Card Holder

Stainless steel card holder that fits most brands of stainless steel cages by sliding tightly onto cage bars

JOR461X Stainless Steel ID Card Holder \$7.20/ea
Standard 3 x 5



BUY NOW

StaySafe - Self-Sealing Bottle Closures

This patented product allows a luer slip syringe to repeatedly withdraw oral liquids from plastic amber pharmacy bottles. The Stay Safe is pressed into bottle opening. StaySafe Closures feature flexible sealing rings for compatibility with a range of bottle sizes. Size 24 fits snugly into most bottles with necks in its I.D. (inner diameter) range of 15.5mm - 18.25mm.

Bottles should be selected for smooth inside necks sized with the stated inner diameter range. A smooth neck optimizes the ability of the closure to provide an effective seal.

JOR1080 24mm/50 Pack \$41.00/ea

BUY NOW

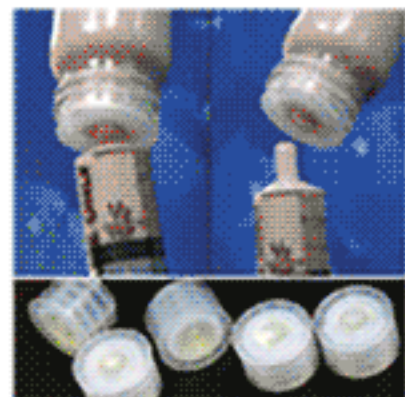

Universal Bottle Adapter

Jorvet

This adaptor features a graduated rubber plug that fits bottle openings 18-22mm. The tethered plug lets you reseal the bottle for later use. Attach oral dose syringe and withdraw desired dose.

JOR578 fits bottle openings 18-22mm, /5pk \$9.60/ea

BUY NOW

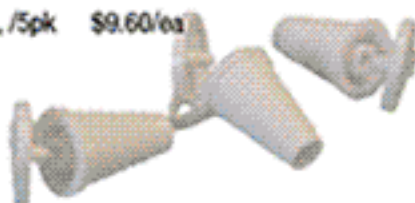

Sterile Culture Tubes

Transparent polystyrene tubes can be used for most routine laboratory procedures. Tubes are supplied with a 2-position ribbed polyethylene cap which can be left open for aerobic work or sealed for anaerobic work. 25/bag.

JOR556A 5 ml, 25/bag \$5.40/bg
JOR556B 16ml, 25/bag \$6.90/bg

BUY NOW



Scalers

Delmarva 2000 Ultrasonic Scaler with Motor Pack

6 year warranty

Ultrasonic Tooth Scaler features:

- Automatic tuning; it recognizes and locks in on each insert.
- Powerful 25k magnetostrictive frequency.
- Programmed power control knob provides optimum energy for all inserts.
- Exclusive 25% power increase for extra boost.
- Accepts all Cavitron style 25k inserts.
- Specialty insert power setting for feline urethral catheters and other inserts.
- Unique low water pressure warning light.

Motor Pack features:

- Speeds of 3000 to 22000 RPMs-wide range for polishing or drilling.
- Foot switch allows hands free operation.
- Hand piece is a sealed unit which generates no heat and requires no lubrication.

DE-1N Includes: Detachable scaler hand piece, Plug-in Micro Motor Hand Piece, 1 TRI 3 insert, 12 prophy cups, 12 prophy paste, 1 prophy angle, in-line water filter, quick release valve, 6 year warranty **\$2,167.65/ea**

BUY NOW

Delmarva 2000 Ultrasonic Scaler

- Automatic tuning; it recognizes and locks in on each insert.
- Powerful 25k magnetostrictive frequency.
- Programmed power control knob provides optimum energy for all inserts.
- Exclusive 25% power increase for extra boost.
- Accepts all Cavitron style 25k inserts.
- Specialty insert power setting for feline urethral catheters and other inserts.
- Unique low water pressure warning light.

Includes: Detachable scaler hand piece, 1 TRI 3 insert, in-line water filter, quick release valve.

DE-2 Includes: Detachable scaler hand piece, 1 TRI 3 insert, in-line water filter, quick release valve **\$1,535.00/ea**

Delmarva 2000 Motor Pack

- Use for polishing, drilling, cutting, rounding...any fine surface procedures.
- Speeds of 3000 to 22000 RPMs-wide range for polishing or drilling.
- Foot switch allows hands free operation.
- Hand piece is a sealed unit which generates no heat and requires no lubrication.

DE-3 Includes: Screw-in micro motor hand piece, 12 prophy cups, 12 prophy paste, and 1 prophy angle **\$974.00/ea**

Dental Handpiece Lubricant

JOR841LA 8oz spray **\$62.00/ea**

BUY NOW

NEW

JorVet Ultrasonic Scaler

Our new magnetostrictive ultrasonic scaler has a sleek design with a small footprint size.

- Operates on 25KHZ
- Includes 2 inserts, one universal and one spatula tip.
- Unique LED display, same as JOR842x
- Foot pedal operation
- 6 year limited warranty
- Dimensions: 6 1/2"W x 9"L x 3 1/2"H
- Weight: 3 lbs 14 oz.

NEW

JOR8420 Accessories JOR45202 & JOR45201P **\$755.00/ea**

BUY NOW

Piezoelectric Ultrasonic Scaler

Piezoelectric ultrasonic scalers differ from the conventional ultrasonic scalers. The piezo handpiece generates its ultrasonic waves via four ceramic plates subjected to high frequency alternation current. The electric mechanical efficiency of this system is much greater than that of traditional magnetostrictive systems.

There is very little heat released and it is possible to work with very little water spray. All available in a sleek, contemporary design with an operation frequency of 29KHZ. Foot pedal operation; unique LED display that indicates the power level that will best perform endo, periodontal work, or scaling. 6 year limited warranty (90 days on tips, 2 years on handpiece).

JOR842X 6.5" x 9" x 3.5", 4 tips included: 2 universal, 1 spatula and 1 periodontal. **\$795.00/ea**

BUY NOW

Piezo Scaler Tip

These tips are for use with the piezo ultrasonic scaler.

JOR842XD2 Spatula tip **\$42.00/ea**
 JOR842XD1 Universal tip **\$42.00/ea**
 JOR842XD3 Periodontal tip **\$42.00/ea**

BUY NOW

Piezo Ultrasonic Scaler Handpiece

This is a replacement handpiece.

JOR842XD4 each **\$209.00/ea**

BUY NOW

Wrench for Piezo Scaler Tips

JOR842XD5 **\$29.00/ea**

BUY NOW

Super Soft Blue Ultrasonic Insert

JOR842MD1 25KHZ **\$144.00/ea**
 JOR842MD2 30KHZ **\$147.00/ea**

BUY NOW

Jorvet Trace Disclosing Solution

This solution will stain a tooth surface bright cherry red if plaque is present. Some Suggested uses:

- A client education aid to show extent of patient plaque
- Evaluation of home tooth brushing effectiveness
- Follow-up to dental prophy to make sure procedure was complete Simple to use: swab an area with moistened cotton tip applicator. 2 oz dispensing bottle with screw cap.

JOR969 60ml **\$12.00/ea**

BUY NOW

NEW

Scalers/Polishers

JorVet Combo Piezo Dental Unit

Our scalers differ from the conventional ultrasonic scalers. The piezo handpiece generates its ultrasonic waves via four ceramic plates subjected to high frequency alternation current. The electric mechanical efficiency of this system is much greater than that of traditional magnetostrictive systems. There is very little heat released and it is possible to work with very little water spray.

- Sleek contemporary design
- Operation frequency 29KHZ
- 4 tips included, 2 universal, 1 spatula and 1 periodontal
- Unique LED display indicates the power level that will best perform endo, periodontal work, or scaling.
- Foot pedal operation
- 6 year limited warranty (90 days on tips, 2 years on handpiece).
- Dimensions: 61/2"W x 9"L x 31/2"H

Weight: 3 lbs. 14 oz.

JorVet

BUY NOW



JOR841X ACCESSORIES AND REPLACEMENT PARTS: JOR842XD1, \$1,340.00/ea
JOR842XD2, JOR842XD3, JOR842XD4, JOR842XD5

JorVet Combo Ultrasonic Dental Unit

This is our new dental combo unit with a sleek design and affordable price! It is the workhorse your hospital needs!!

- Contemporary design with a small footprint
- Operation frequency 25kHz
- Includes in-line water filter, 2 inserts (1 spatula, 1 universal), micro-motor, polisher handpiece, prophylaxis angle, prophylaxis cups and paste starter kit
- Comes with quick release attachment for water tank set-up (optional water tank JOR45264)
- Large, easy to read LED power display
- Micromotor variable speed 2,000-30,000 rpm with forward/reverse
- Foot pedal operation
- Optional drilling and sectioning attachments available
- 6-year limited warranty (90 days on inserts and prophylaxis angle, 1 year on the handpiece)
- Dimensions: 6"L x 8"W x 3.5"H
- Weight: 6.5 lbs.

BUY NOW

JOR8410 110v \$1,210.00/ea



Combo Ultrasonic Dental Unit

Magnetostrictive ultrasonic scaler/polisher, 25K. Compact unit comes with 2 inserts, prophylaxis angle, polishing cups and paste.

BUY NOW

JOR8410V 220v \$1,170.00/ea



Soft Tissue Protector

Soft Tissue Protector. Fits polishing head of a dental unit.

JOR41ST Cross Cut Burr Sold Separately \$105.00/ea

X-long Cross Cut Burr

Extra-Long Cross Cut Burr. For use with above soft tissue protector.

JOR41CC Soft Tissue Protector Sold Separately \$10.00/ea



BUY NOW

Jorvet Pro Scale Polishing Unit

BUY NOW

- 300-30,000 rpm
- 1:1 straight handpiece
- Metal prophylaxis angle, forward & reverse functions
- Starter kit includes prophylaxis paste and polishing cups
- Extra disposable prophylaxis angles
- Operates from either foot switch or push-button control
- May be used with optional diamond cutting discs, contra angle, and diamond burs
- 12-month warranty

NEW

JOR453 110 Volt \$670.00/ea
JOR453A 220 Volt \$650.00/ea



Scaler/Polisher Accessories

Rubber Cups for Polishing (A)

JOR452D6 Rubber, 100/PK \$13.00/pk

Screw-On Prophylaxis Cups

"S"-Shaped Hand Rasp. This is especially useful as a finishing tool on the upper premolars.

JOR452D5 100 pack \$22.50/pk
JOR452D6S 100 pack \$15.60/pk

Prophylaxis Polishing Paste (B)

Flavored, Grey with fluoride. Offered in a large bulk container or pack of 100

JOR452D5B Bulk, 12oz Container \$20.40/ea

Ultrasonic Insert Spatula Tips (C)

JOR452D2 \$81.00/ea
JOR452D1P \$81.00/ea

Prophylaxis Paste Ring

JOR452D5R Not Pictured \$7.05

Diamond Cutting Disc (D)

Diamond cutting disc for trimming incisors, fits directly into the JOR841 handpiece.

JOR452D7 Fits into Handpiece \$36.00/ea

Metal Prophylaxis Angle (E)

Dental Accessories & all dental inserts are compatible with other manufacturers of Cavitron dental scalers.

JOR452D3 slip fit \$32.10/ea

Contra Angle (F)

Diamond cutting disc for trimming incisors, fits directly into the JOR841 handpiece.

JOR452D9 Friction Grip \$143.00/ea

Portable Water Tank (G)

Dental Accessories & all dental inserts are compatible with other manufacturers of Cavitron dental scalers.

JOR452D4 1-gallon, Ea \$66.00/ea

Handpiece Cord

JOR452HP \$105.00/ea NOT SHOWN



Diamond Disc Safety Shield

JOR41SS Safety shield only \$105.00/ea

Rodent & Small Animal Dental

Jorvet Rabbit/Rodent Dental Starter Kit

A convenient cost saving kit that gets the practitioner started with the basics for this expanding field.

BUY NOW

JORS1RK KIT INCLUDES: \$200.00/ea
 MOUTH GAG
 CHEEK DILATORS LARGE
 CHEEK DILATORS SMALL
 RODENT DENTAL MOLAR CUTTERS
 RODENT MOUTH SPATULA
 MOLAR RASP FOR "FLOATING" TEETH
 INSTRUMENT STORAGE TRAY

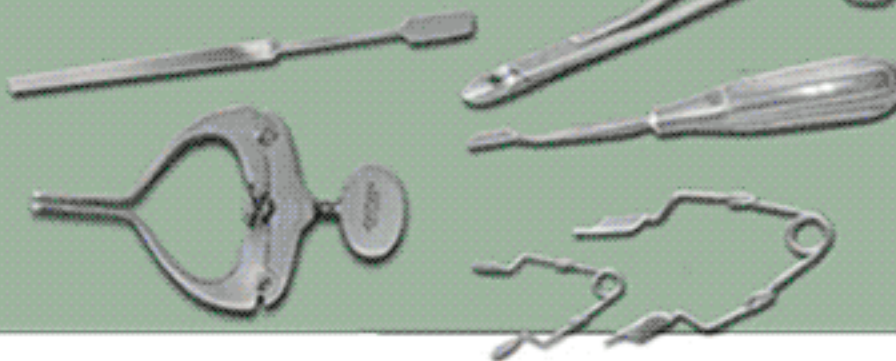

Rodent Mouth Gag

Examination of the rabbit mouth is virtually impossible without a gag of this type.

JORGENSEN JORS1RG \$75.00/ea



BUY NOW

Jorvet Rabbit/Rodent Dental Head Support

If you are serious about rabbit/rodent dentistry, this is the piece of equipment you need. This special device is designed for hands-free dental work on smaller pocket pets and rabbits. The support tilts to various angles. Two metal posts hold a mouth speculum via thin metal adjustable bars. This also serves to hold the animal's head steady and the mouth open to exactly the desired size. Fiber composite base.

BUY NOW

JOR931 12cm W x 19-27cm H x 23cm D. \$395.00/ea



Rabbit Speculum LED Light

JOR931A Stand Sold Separately \$148.00/ea



NEW
BUY NOW

Rodent Molar Cutter

Used to deflect tongue and cheeks to enable best possible view of problems.

JORS1RM \$105.00/ea

JOR41MC \$48.00/ea

BUY NOW



Rodent Dental Spatula

Used to deflect tongue and cheeks to enable best possible view of problems.

JORS1RS \$24.00/ea



BUY NOW

Jorvet Rodent Cheek Dilator

The cheek dilator allows visualization of molars and protects cheeks from instruments.

JORS1RDLX Large with long reach \$21.00/ea

JORS1RDS Small. Also useful as a gag for guinea pigs and chinchillas. \$21.00/ea

BUY NOW

Jorvet Rodent Molar Extractor

Used to deflect tongue and cheeks to enable best possible view of problems.

BUY NOW

JOR41ME \$48.00/ea



Rodent Tooth Rasp

Molar Rasp (rabbits). Unsuitable for debulking but good for removal of small spurs.

JORGENSEN JORS1RR \$60.00/ea

BUY NOW



Dental Wedge

The use of a mouth gag or speculum is a common procedure in small animal medicine. Maintaining an open mouth is a requirement for many dental cases and for proper examination of the upper airways. The wedge is a clear plastic mouth prop that features:

- Anatomic design for proper, secure placement between premolars and molars
- Radiolucent for unobstructed radiographs
- Autoclavable
- A hole is provided to attach a suture for emergency removal
- Can be used if canine teeth are absent
- Soft and pliable for patient comfort.
- Suggested uses: intubation, oral surgery, dental procedure, oral exam, radiographic exam.

BUY NOW



JORS10 Small \$19.50/ea

JORS1R Large \$19.50/ea



Rodent Cheek Dilator

JORS1RDL Large \$21.00/ea



Root Tip Pick

BUY NOW

Heid Brink tooth ejector. Sometimes during extraction, tooth fragments can break off and remain in the socket. This instrument has a thin delicate tip that helps loosen and remove those remaining fragments.

JOR42X \$19.50/ea



Jorvet Lightweight Rodent Mouth Gag

Smaller with less bulk than standard rodent gag. Knurled knob adjusts opening.

JORS1RGS \$60.00/ea

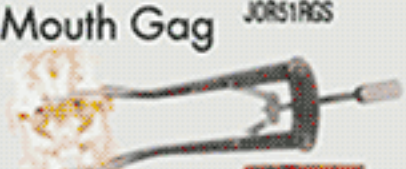

Nazzy Ferret Mouth Gag

A smaller version of the feline gag. This works very well on ferrets, kittens, and small puppies.

JORS1G 1 1/8" \$35.00/ea



Mouth Gags Propphy Kits

Mouth Gags

GERMAN	33-281	2.5"	\$19.00/ea
	33-282	3"	\$19.00/ea
	33-283	4.5"	\$19.00/ea
	33-284	5.75"	\$19.00/ea
	33-285	6.75"	\$19.00/ea

Canine Gag

Spring action with nylon inserts for less trauma. Three sizes available.

JORS1A	Small, 4 1/2"	\$14.70/ea
JORS1B	Medium, 5"	\$15.00/ea
JORS1C	Large, 6 3/4"	\$15.60/ea
JORS1D1	Inserts, Pair, Canine	\$3.30/ea

Smith-Baxter Mouth Gag

Gag. For large dogs. Stainless steel.

JORS1S8A	Small	\$15.00/ea
JORS1S8B	Medium	\$15.00/ea
JORS1S8C	Large	\$18.00/ea
JORS1S8D	X-large	\$21.00/ea

Feline Gag

Small and lightweight.

JORGENSEN	JORS1F	Stainless Steel, 3"	\$10.80/ea
	JORS1F01	Inserts, Pair, Feline	\$3.30/ea



BUY NOW



BUY NOW



BUY NOW

BUY NOW



Prophylaxis Dental Kit

BUY NOW

DENT-ECON	Includes Probe, 2x Scalers, Curette, Mirror	\$32.00/ea	ECONOMY
DENT-MIL	Includes Probe, 2x Scalers, Curette, Mirror	\$125.00/ea	MILTEX

Small Animal Basic Propphy Kit

This kit is designed to provide complete instrumentation for dental cleaning and examination. The following 6 German instruments are included in the kit: Dental Mirror, Jaquette Scaler 2s/3s, Jaquette Scaler 6s/7s, Columbia Curette c2i/c2r, Mccall's Curette 11/12, and an Explorer/Measuring Probe.

JOR41K	6 German Instruments	\$105.00/set
--------	----------------------	--------------

BUY NOW

JOR41e

JOR41j

JOR41m

JOR42q

JOR41p

JOR41i

Small Animal Rainbow Propphy Kit

This kit contains all the instruments needed for doing the proper dental examination and cleaning.

The kits has the following features:

- Cryogenically-treated 440A-USA stainless steel is guaranteed harder, tougher and will hold it's edge 2-7 times longer than competitor's.
- Ultra-large handle for premium comfort combined with the light weight instrument reduces risk of Carpal Tunnel Syndrome
- Exclusive extended knurling pattern gives you maximum control for leverage as well as torque.
- Anatomically color-coded to speed up set-ups and pick-ups.
- Kit comes with a sterilization cassette tray useful for sterilization and storage.

Instruments Included are:

- (1) Mirror #4, (1) Explorer #2, (1) Explorer/Probe 23/12, (1) Jaquette Scaler 2s-3s, (1) Jaquette Scaler 6s-7s, (1) Columbia Curette 4r-4l, and (1) Columbia Curette 13-14.

JOR973N 7 instruments, Tray and Dental Chart. Instruments available in Propphy Kit or Individually.

\$246.00/set

BUY NOW

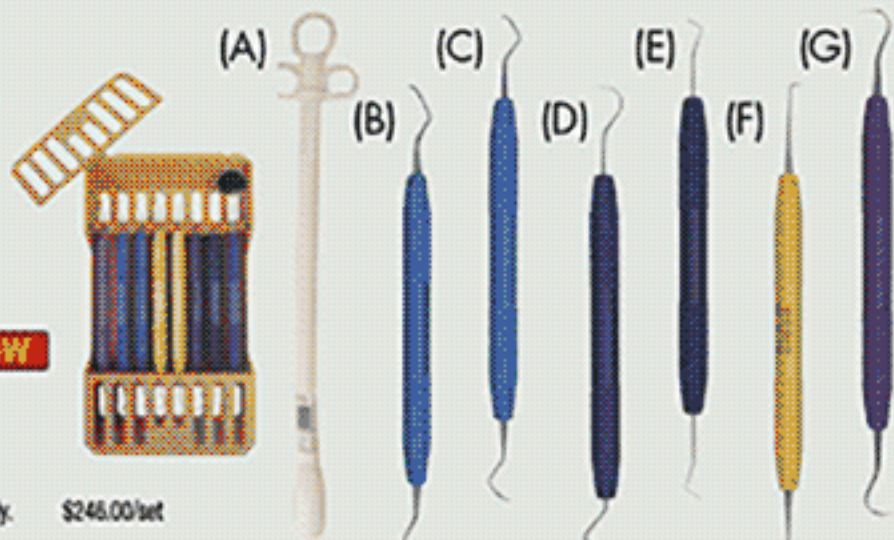

Rainbow Blue Dental Mirror #4 (A)

JOR973A	Diagnostic: Visual Inspection.	\$17.60/bx
JOR973AN	Diagnostic: Visual Inspection.	\$25.50/ea

Rainbow Dental Explorer/Probe (D)

JOR973CN	Pacific Blue	\$28.00/ea
----------	--------------	------------

Rainbow Jaquette 34-35 (F)

JOR973DN	Rainbow Yellow	\$32.00/ea
----------	----------------	------------

Rainbow Columbia 4R-4L Curette (B)

JOR973FN	Nautical Blue	\$32.00/ea
----------	---------------	------------

Rainbow Explorer #2 (E)

JOR973B	Pacific Blue	\$19.60/ea
JOR973BN	Pacific Blue	\$38.00/ea

Sickle Scaler 204S (G)

JOR973EN	Sunshine Purple	\$32.00/ea
----------	-----------------	------------

Rainbow Columbia 13-14 Curette (C)

JOR973GN	Nautical Blue	\$32.00/ea
----------	---------------	------------

Curettes, Files & Rasps

Jorvet Crossley Molar Luxator

Jorvet

Designed to facilitate extraction of molars with a minimum of damage to the alveolus and surrounding soft tissue. One cutting blade is for insertion down buccal or lingual surface. The other end of the instrument is set at right angles to penetrate between molars.



JOR41MR \$45.00/ea

BUY NOW



Jorvet Crossley Rabbit Incisor Luxator

Incisor malocclusion with resulting over growth is a common and serious problem in rabbits. Frequent clipping is required with the risk of splitting the incisors. Extraction is the only permanent solution but the roots of the incisors are large relative to the jaw. The Crossley incisor luxator was designed especially for this procedure. The instrument matches the shape of the rabbit incisor. It is double ended for various size incisors. Complete with instructions for use.



JOR41CR \$45.00/ea

BUY NOW

Dental Curette

MIL70-50

Curettes are used to remove subgingival calculus, for root planing and for curettage. They have one blade with two cutting edges. Both cutting edges may be used on the front and back of the tooth.

BUY NOW



Vendor	Item#	Details	Price
ECONOMY	DB#5/6	Barnhart 5/6	\$9.95/ea
	DG7/8	Gracey 7/8	\$9.95/ea
Integra/Miltex	MIL70-50	#13/14 D/E	\$27.69/ea

McCall's Curette

BUY NOW

Designed to remove subgingival calculus. To root plane, use short quick over lapping strokes.

JOR41F Double Ended, 11,12

\$22.50/ea

Double Ended Subgingival Curette

Gracey style. Subgingival curette for important removal of necrotic debris below the gumline. Often overlooked but necessary for proper dental care. England.

JOR42S Stainless steel, 6" \$15.00/ea

BUY NOW

Columbia Curette

Designed to remove subgingival calculus. To root plane, use short quick over lapping strokes.

JOR41E Double Ended, C2L/C2R \$24.00/ea
 JOR41EA Double Ended, 13, 14 ss \$22.50/ea

BUY NOW



Dental Files

Vendor	Item#	Details	Price
GERMAN	DBFH12	Howard #12	\$38.00/ea
	DF64	Miller #64	\$9.95/ea
	DFFP	FPS34	\$12.47/ea

BUY NOW

Dental Extraction Kit

D-EXTRACT 7 instruments \$90.50/pk

BUY NOW

NEW

Dental Prophylaxis Kit

D-PROPHY 5 instruments \$39.95/pk

BUY NOW



DG7/8

Dental Curette

MIL70-50

Curettes are used to remove subgingival calculus, for root planing and for curettage. They have one blade with two cutting edges. Both cutting edges may be used on the front and back of the tooth.

BUY NOW



Vendor	Item#	Details	Price
ECONOMY	DB#5/6	Barnhart 5/6	\$9.95/ea
	DG7/8	Gracey 7/8	\$9.95/ea
Integra/Miltex	MIL70-50	#13/14 D/E	\$27.69/ea

McCall's Curette

BUY NOW

Designed to remove subgingival calculus. To root plane, use short quick over lapping strokes.

JOR41F Double Ended, 11,12

\$22.50/ea

Double Ended Subgingival Curette

Gracey style. Subgingival curette for important removal of necrotic debris below the gumline. Often overlooked but necessary for proper dental care. England.

JOR42S Stainless steel, 6" \$15.00/ea

BUY NOW

Diamond Molar Rasps

BUY NOW

Unsuitable for debulking, but good for tidying. The diamond rasp's surface is concave to fit over the molars without slipping off. Diamond grit is the ideal material to remove tooth spurs without damaging the delicate root structure.

JOR41GF Molar Rasp-fine, For guinea pigs & chinchillas. \$36.00/ea
 JOR41R Rasp, Molar For Rabbits \$36.00/ea
 JOR41RF Fine Diamond \$69.00/ea



Explorers/Probes

BUY NOW

Vendor	Item#	Details	Price
ECONOMY	DPPE	Explorers/Probes	\$7.95/ea
	DEX5	Explorer #5	\$2.00/ea
	D/WPP	PERIOSTIAL PROBE	\$8.95/ea
Integra/Miltex	MIL69-6337	Probe/Explorer	\$35.36/ea

Pet Dental Care Products Available in our Pet & Grooming Section



Elevators

Dental Elevators

BUY NOW



Vendor	Item#	Details	Price
GERMAN	D#34	#34 3/16	\$9.95/ea
	D#34S	#34S 1/8	\$12.00/ea
	D#46	#46 3/32	\$9.95/ea
	D#78	#78 Root Tip	\$12.95/ea
	D#301	#301 1/16	\$12.95/ea
MILTEX	MILDEL-34	#34 3/16	\$68.18/ea
	MILDEL-34S	#34S 1/8	\$66.48/ea
	MILDEL-46	#46 3/32	\$68.18/ea
	MILDEL-78	#78 Root Tip	\$68.18/ea
	MILDEL-301	#301 1/16	\$66.48/ea
JORGENSEN	JOR43M	Medium, Straight 3mm	\$13.20/ea

Canine Dental Elevator (A)

BUY NOW

JOR41A	Small, Cats and fractured tooth tips. 2mm head. 6".	\$44.00/ea
JOR41B	Medium, Mid-sized dogs. 3mm head. 6".	\$54.00/ea
JOR41C	Large, Large dogs and K-9 teeth. 4mm head. 6".	\$54.00/ea

Delicate Feline Dental Elevator

JOR8970 #301 pattern \$25.50/ea



Winged Dental Elevator

BUY NOW

Vendor	Item#	Details	Price
GERMAN	WE1	1mm Wide	\$15.95/ea
	WE2	2mm Wide	\$15.95/ea
	WE3	3mm Wide	\$15.95/ea
	WE4	4mm Wide	\$15.95/ea
	WEF	V-SHAPE, Feline	\$17.95/ea
JORGENSEN	JOR897A	1mm Wide	\$25.50/ea
	JOR897B	2mm Wide	\$25.50/ea
	JOR897C	3mm Wide	\$25.50/ea

Set of 4 Winged Dental Elevators

JOR897S \$83.00/ea

BUY NOW

Periosteotome

JORGENSEN JOR899 6" L

\$18.00/ea

BUY NOW

Wolftooth Elevator Set

This attractive professional looking kit has six different instruments to help elevate any size of wolf tooth.



Different elevators:

- 5mm sharp concave point with rounded backside, 6"
- 5mm sharp concave point with a curved head, 6" length
- Large 9mm concave sharp head, 6" length
- Longer, heavier handle with a 5mm slightly curved deep concave head, 9" length
- Longer, heavier handle 5mm deep concave head, 9" length
- 9mm concave curved replaceable head on ergonomic curved heavy handle, 8" length
- All in handy, padded black zipper pouch with red velvet lining

JOR43Y \$99.00/ea

BUY NOW



Wolftooth Elevator Set

Two different head sizes allow this instrument to "cap" the wolf tooth. By rotating clockwise and counter clockwise, the tooth can be separated from the alveolus. Angulated head is useful on teeth that are set well back.



JOR43AB Stainless Steel, 1/4" and 3/8" Heads. \$110.00/ea

BUY NOW

Wolftooth Elevator

The length of the blade can be shortened or lengthened as desired by loosening the set screw with the wrench.

JOR43W \$23.25/ea

BUY NOW



Deluxe Wolf Tooth Elevator

JOR709 with Ergonomic Handle., 22cm L. \$99.00/ea

Double End Elevator 4mm **Jorvet**

This double-ended elevator has a unique veterinary design. The fine tips are both curved with an elevator groove. One end of the groove is on the inside concave side and the other end of the groove is on the outside convex side. This allows the elevator to follow the large root curves which exist on many animal teeth (i.e., deciduous canine teeth).

JOR42Y Stainless Steel Knurled 7 1/4" L handle. \$33.00/ea

BUY NOW

Dental Elevator with Notched "V" Tip.

Holds dental burrs into a convenient and easy to see block. The magnetic base holds up to 14 burrs securely. Drain holes prevent rusting. Non-slip feet add stability. Autoclavable. Cover sold separately.

BUY NOW

JOR899A	Elevator tip on outside of curved tip	\$24.00/ea
JOR899B	Elevator tip on inside of curved tip	\$24.00/ea
JOR899C	Elevator tip on inside of curved tip	\$24.00/ea
JOR899D	Elevator tip on inside of curved tip	\$24.00/ea
JOR899S	Set of all 4	\$76.00/ea

Explorers, Mirrors, Scalars & Scrapers

Explorer/Measuring Probe

The delicate explorer tip is used for increased tactical sensitivity in the gingival sulcus. It locates subgingival calculus and can be used to check tooth mobility. The periodontal measuring probe is graduated in millimeters. It is held parallel to the long axis of the tooth and measures gingival sulcus depth.

JOR420 6 1/2" \$27.00/ea

BUY NOW



Mouth Mirrors

Vendor	Item#	Details	Price
ECONOMY	DCDM	Size 4	\$13.50/ea

BUY NOW

Dental Mirror

JOR41MI Dental Mirror, 22mm (7/8") dia. \$9.00/ea

BUY NOW

Integra/Miltex Dental Mirror Handle

MIL67-685 #3 \$52.57/ea

BUY NOW

INTEGRA *Miltex*

Percussion Chisel

Dental Chisel with sliding bar or percussion handle. The working end has a notched "V". It works great for removing upper premolar hooks and lower rear molar hooks. Stainless steel.

JOR701 23" L, collapsed

\$168.00/ea

BUY NOW

S-Floted Hand Rasp

"S"-Shaped Hand Rasp. This is especially useful as a finishing tool on the upper premolars.

JOR702 Tungsten carbide, 30cm L.

\$105.00/ea

BUY NOW

Jacquette Scaler

Designed to remove supragingival calculus with sharp pull strokes. The scaler tip is triangular in shape with a sharp tip.

BUY NOW

Vendor	Item#	Details	Price
GERMAN	D2Y/3Y	Jacquette 2Y/3Y	\$7.95/ea
Integra/Miltex	MIL70-100	Jacquette 2/3	\$43.01/ea
	MIL70-126	6/7-Octagonal, D/E	\$43.01/ea
JORGENSEN	JOR41J	Double Ended, 2, 3 ss	\$24.00/ea
	JOR41J	Double Ended, 2, 3 ss	\$24.00/ea
	JOR41JA	Double Ended, 6, 7	\$22.50/ea

Periodontal Scaler Jacquette

BUY NOW

Vendor	Item#	Details	Price
Integra/Miltex	MIL70-94	Jacquette scaler 1Y/1YS Double Ended	\$35.84/ea
	MIL70-96	4 3/4", 2y/3y, Periodontal	\$35.84/ea

Periodontal Scalars

Vendor	Item#	Details	Price
ECONOMY	DH6/7	Sickle, H6/7	\$11.50/ea
GERMAN	DS2/3	Jacquette 2/3	\$7.95/ea

BUY NOW

Tartar Scrapers

BUY NOW

Vendor	Item#	Details	Price
ECONOMY	D#3	#3 Octagonal, S/E	\$12.95/ea
Integra/Miltex	MIL70-108	#3 Octagonal, S/E	\$35.84/ea
	MIL70-110	#12 D/E	\$43.01/ea
	MIL70-116	Whiteside-Octagonal	\$35.84/ea
	MIL70-120	15/30-Universal D/E	\$43.01/ea

Dental Scraper

JOR42J #6, Stainless steel, 6"L. \$4.50/ea

BUY NOW

MIL60-50/2

JOR42A

Canine Tartar Scraper

BUY NOW

Vendor	Item#	Details	Price
ECONOMY	D#12	#12	\$9.95/ea
Integra/Miltex	MIL60-50/2	Curved/Straight Edge	\$25.57/ea
	MIL60-50/4	Triangle	\$24.93/ea
JORGENSEN	JOR42A	Triangular, Stainless steel, 5 3/4"	\$4.80/ea
	JOR42B	Double-end curved ends with angular edges, Stainless steel, 6 3/4"	\$21.00/ea

Stainless Probe

11-1280 Mail Probe \$3.00/ea

Dental Supplies

Burrs, Tooth Cutters & Germicide

Rabbit Burr-Kit

JOR41RK Bit only 3pk \$95.00/
pk



BUY NOW

Extra Long Cross Cut Burr J41RK

JOR41R0L Bit only, Bit only, for JOR41RK \$15.00

BUY NOW

Taper Side Cut Burr

JOR41RKT5 Bit only, 2.3mm, for JOR41RK, Bit only, for JOR41RK \$15.60/ea

BUY NOW

Round Burr Only for JOR41RK

JOR41RKR Bit only Bit only, for JOR41RK

BUY NOW

\$15.00/ea

Diamond Dental Burr

Diamond Dental Burrs. Seven. Use with contra angle. Includes handy display tray.

JOR45208M Set of 7 \$52.50/pk

BUY NOW



Dental Burr Block

BUY NOW

Holds dental burrs into a convenient and easy to see block. The magnetic base holds up to 14 burrs securely. Drain holes prevent rusting. Non-slip feet add stability. Autoclavable. Cover sold separately.

JOR944 Holds up to 14 burrs \$19.80/ea

Clear Cover for Dental Burr Block

JOR944C Clear. Not autoclavable, use only with cold sterilization. \$7.80/ea



BUY NOW

Dental Hand Instrument Tray

Organizes and stores up to six hand instruments. Autoclavable up to 270 degrees Fahrenheit. Caution do not use dry heat

JOR943 3.625" x 7.75" \$11.40/ea

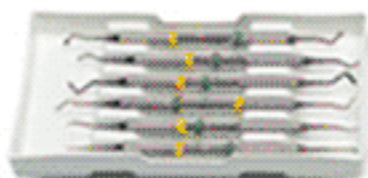

BUY NOW

Tooth Punch-Straight

The punch is used for removal of cheek teeth through a trephined hole into the sinus. A knurled handle gives a better grip. A round head with a slight recessed area fits better onto the tooth. Stainless steel.

JOR712 20cm L. \$43.50/ea



BUY NOW

Tooth Cutter

BUY NOW

Molar Cutter. The most effective design of a molar cutter has a parallel alignment of the jaws to the tooth surface. This allows the whole tooth to be trimmed, not just at the narrow point of attachment. The jaws of this instrument are a special hardened tempered steel. Knurled handles for a non-slip grip.

JOR707 Straight-56cm \$675.00/ea
JOR708 Angled-56cm \$795.00/ea



Twitch

BUY NOW

Kendall model. Complete with tie rope.

JOR44 Stainless steel, 13" \$15.75/ea



JOR43RU

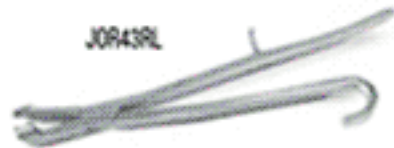

JOR43RL

Reynold's Equine Tooth Extractor

Jorvet

This is the recommended instrument for retained deciduous teeth (caps) in horses. Also works for small premolars and incisors.

JOR43RU Upper Jaw. Stainless steel. 15"L (38cm). \$94.00/ea
JOR43RL Lower Jaw. Stainless steel. 15"L (38cm). \$94.00/ea

BUY NOW

Pig Tooth Nipper

JOR42H Nickel-plated. 5 1/2"L. \$18.00/ea
JOR42HS Stainless steel. 5 1/2"L. \$9.90/ea



BUY NOW

Jorvet Pink Germicide

An inexpensive disinfectant that allows the submerged instrument to be quickly used after just 10 minutes. It has an anti-corrosive agent that makes it safe to use with stainless steel instruments.

Germicide's advantages:

- Quaternary ammonium compound
- Fast acting
- Low Toxicity
- Ready-to-use, no dilution needed

JOR883 One Gallon \$16.80/gl



BUY NOW

Extractors & Forceps

Wolffooth Extractor Set

Stainless steel.

JOR711 Comes in convenient canvas case. \$302.00/ea

BUY NOW

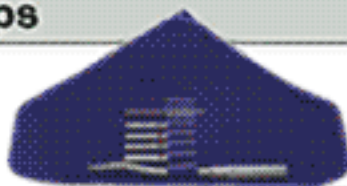

Wolffooth Extractor Forcep

Wolffooth Extractor Forceps. Stainless steel.

JOR43H 11 1/2"L. \$49.50/ea

BUY NOW



Dental Forceps

BUY NOW

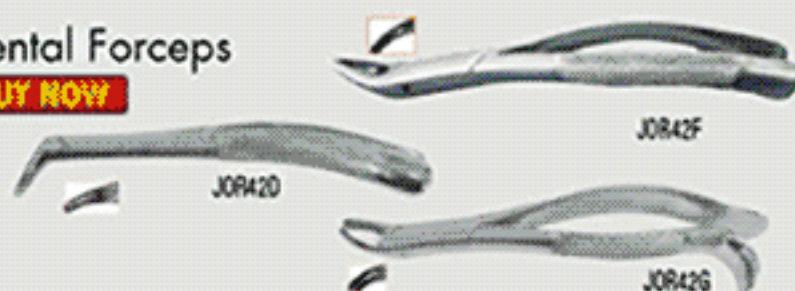

Vendor	Item#	Details	Price	
ECONOMY	D#150S	#150 1/2S, 4 3/4"	\$37.00/ea	
	D#151	#151, 6 1/2"	\$37.00/ea	
	D#6	Split/Separate	\$24.00/ea	
	D#62	#62, 6 1/2"	\$77.00/ea	
	D#65	#65	\$24.00/ea	
	D#120	K9/Cat, 6"	\$24.00/cs	
	Integra/Miltex	MILDEF-120	K9/Cat, 6"	\$205.03/ea
		MILDEF-150S	#150 1/2S, 4 3/4"	\$121.30/ea
		MILDEF-151	#151, 6 1/2"	\$153.31/ea
		MILDEF-6	Split/Separate	\$153.31/ea
MILDEF-62		#62, 6 1/2"	\$153.31/ea	
JORGENSEN	JOR420	7"L	\$22.50/ea	
	JOR42F	7"L	\$22.50/ea	
	JOR42G	7"L	\$22.50/ea	

Extraction Forceps

BUY NOW

Universal Small Tooth Extracting Forceps.

JOR705 Stainless steel. 17"L. \$564.00/ea



Small Extracting Forceps Kit

Useful for small wolf teeth and tooth fragments. One forceps is useful for spreading incisors before extraction. Set of three forceps configured with varied angled heads make it easier to extract wolf teeth or fragments out of tight spots.

JOR42K 7" length. \$92.00/ea

BUY NOW



Feline Dental Extractor

BUY NOW

Smaller Feline Dental Extractor with spring loaded handles.

JOR42R Stainless steel. 4 1/2". \$39.00/ea

This extractor is smaller and lighter weight with special jaws that close together along their whole interface. Especially designed for small dog and feline teeth or tooth fragments. Also useful in removing tartar/calculus.

JOR42T Made in England. 6". \$33.00/ea

BUY NOW



Three Root Extracting Forceps

JOR1092 Three root extraction forceps, On side 21" \$180.00/ea

JOR1092A Three root extraction forceps, Off side 21" \$180.00/ea

BUY NOW

Three Root Extracting Forceps (Mini)

JOR1092B Smaller version in length and forceps head size, On side 12" \$140.00/ea

JOR1092C Smaller version in length and forceps head size, Off side 12" \$140.00/ea

BUY NOW

Four Root Dental Extraction Forceps

JOR1093 21" \$180.00/ea

JOR1093A Mini 12" \$140.00/ea

BUY NOW



Heavy Calculus/Tarter Removal Forceps

Very heavy deposits of calculus often develop on the carnassial and other teeth. It is preferred to remove these large hard deposits with this instrument rather than using an ultrasonic scaler or an expensive orthopedic rongeur.

JOR898A Small. 4 1/2"L. \$48.00/ea

JOR898B Large. 5 1/2"L. \$48.00/ea

JOR898S Set of two \$86.00/ea

BUY NOW



Angled Tooth Fragment Forcep

A perfect instrument for broken tooth fragments or small delicate teeth such as cat incisors. Angled.

JOR899T 4 3/4"L. \$24.00/ea

JorVet



Deciduous Incisor Tooth Extractor

Spring handle increases holding power. Stainless Steel.

JOR703 20cm L. \$552.00/ea

BUY NOW

Deciduous Incisor Tooth Extraction Forceps

Deciduous Premolar "Cap" Extraction Forceps. Designed by Dr. Stelzer. German-made high quality forceps. Slightly curved.

JOR704 Stainless steel. 17"L. \$550.00/ea

BUY NOW



Short/Narrow Jaw Molar Extractor Forceps

Serrated short jaw creates good purchase on cheek and premolar retained deciduous teeth.

JOR43B \$180.00/ea

BUY NOW



JorVet

Cochran Dental X-ray Positioner

Small animal dental radiography is vital to the successful diagnosis and treatment of dental disease. However, obtaining accurate intra-oral films can be challenging unless the proper techniques are used. Bisecting Angle Imaging is a well-established technique in both human and veterinary dentistry. With this approach, even the most difficult to reach teeth are properly radiographed. The patented COCHRAN BISECTING ANGLE DENTAL X-RAY POSITIONER will help veterinarians and technicians get excellent quality films each time. What is a Bisecting Angle? - In any 90-degree arc there is one angle at which an X-ray beam will accurately shadow the tooth on film. This is the bisecting angle: the bisection of the long axis of the tooth and the angle of the film. The X-ray beam is directed perpendicular to the bisecting angle for the perfect undistorted image.

FEATURES AND BENEFITS

- Perfect for any teeth, especially
- Canine teeth
- Maxillary Premolars and Molars
- Incisors, especially maxillary
- No more film taped to tongue depressors or forceps that must be hand-held or "propped up" for filming
- Set the angle, lock in place, and step out safely for radiographing
- Virtually eliminates hand motion and blurring of the film
- Elongation, shortening, overlapping of teeth and surrounding structures eliminated or greatly minimized with the bisecting angle technique
- May be used with beam limiting devices (cones) and standard collimator heads
- Accommodates standard film, Computed (CR) film, and Digital (DDR) film
- Lightweight for easy handling, will not add pressure on patients' mouths

JOR1008 \$220.00/ea

BUY NOW



DISCONTINUED

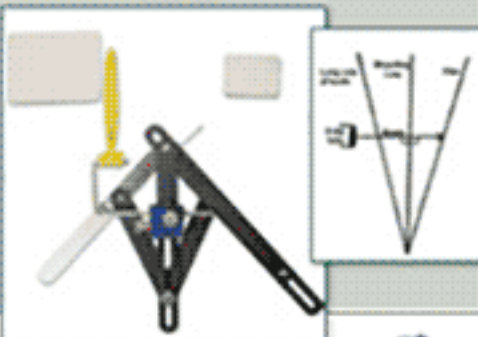

Jorvet Equine Dental Fulcrum

Use as a fulcrum to gain leverage in conjunction with a molar extraction forceps when extracting large cheek teeth.

JOR705F Dual End. 22" (54cm) L. \$238.00/ea

BUY NOW

Jorvet Dental X-ray Film Mounts

Veterinarians are increasingly using specific dental x-ray machines. A dental x-ray unit uses very small dental film and requires multiple film pieces. This small film is difficult to store and catalog correctly. The dental film mounts help solve this problem.

BUY NOW

- | | | |
|---------|--|------------|
| JOR977 | Handy dispenser box containing 1,000 mounts for 500 pairs in vertical side-by-side format. You tear off as many as needed. | \$44.00/ea |
| JOR977A | Side-by-side, 100pk | \$14.50/pk |
| JOR977B | Four mounts in a horizontal row, 100pk of fours. | \$20.50/pk |

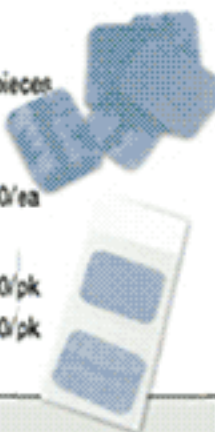

Equine Dental Instruments

BUY NOW

A large dental patient like a horse needs oversized equipment. These dental probes, scalers, and explorers are giant sized to 19" with knurled handles. If you do a lot of equine dentistry, you are going to find them very useful.

- | | | |
|---------|---|-------------|
| JOR440 | Explorer or Shepherd's Hook | \$36.00/ea |
| JOR440A | Sickle Shaped Scaler | \$36.00/ea |
| JOR440B | Sickle Shaped Scaler-Heavy | \$36.00/ea |
| JOR441 | Dental Probe Heavy Tip, Calibrated probe is used to measure depth of periodontal pockets | \$47.00/ea |
| JOR441A | Dental Probe Fine Tip, Finer calibrated tip for pulp horns and tooth surface pockets on the occlusal surface of cheek teeth. | \$47.00/ea |
| JOR441B | Periodontal Forceps, 41cm (16.4"). Heavy-duty right angle forceps is useful for removing forage or debris from periodontal pockets. | \$126.00/ea |



EquiVet Dental Pick

JOR939 Stainless Steel, Sharp, 19", 48cm \$54.00/ea

BUY NOW

EquiVet Parellel Gingival Elevator

JOR939B Stainless Steel, 19", 48cm \$57.00/ea

BUY NOW

EquiVet Perpendicular Gingival Elevator

JOR939A Stainless Steel, 19", 48cm \$57.00/ea

BUY NOW



Equine Instruments

EquiVet Cheek Retractor (A)

Pulls the cheek gently away from the cheek teeth so occlusion can be evaluated on a closed mouth. Also useful for providing more room when power float equipment is being used. By turning retractor around, you get two sizes.

JOR938 Stainless Steel \$55.00/ea **BUY NOW**

EquiVet Dental Mirror (B)

Large mirror angled at 30°. "T" shaped handle. Large mirror angled at 30°. "T" shaped handle.

JOR938M 19" length \$70.00/ea **BUY NOW**

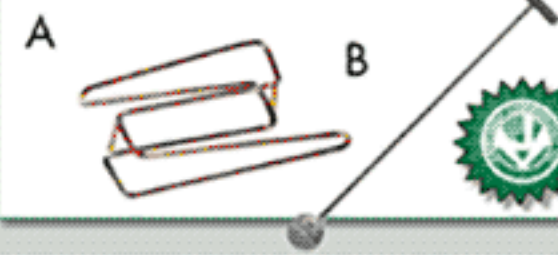

EquiVet Cap Forceps w/Flexible Head (C)

EquiVet Cap Forceps with flexible head. This cap retained deciduous teeth removal forceps gives a better grip as the heads swivel to fit the actual shapes of the cap. Universal for both upper and lower jaws.

JOR43X Stainless Steel \$211.00/ea **BUY NOW**

Equine Universal Dental Extraction Forceps (D)

Designed by Dr. Seltzer. High-quality. German-made.

JOR706U \$657.00/ea **BUY NOW**

Equine Molar Cutter (E)

Powerful compound action. Breakdown model for easy storage.

JOR42 Stainless steel. 11 1/2" handle. 25°L. \$190.00/ea **BUY NOW**

Equine Molar Forcep (F)

Designed by Dr. Seltzer. High quality. German-made.

JOR43 Stainless steel. 17 1/2" \$90.00/ea **BUY NOW**



Trephine Set

JOR706TS (handle and 3 heads) Not Pictured \$430.00/ea **BUY NOW**

Trephine Handle Only

JOR706THH Not Pictured \$76.00/ea

Trephine Head Only

For Larger Head Sizes Not Pictured

JOR706THL	25mm	\$120.00/ea
JOR706THM	22mm	\$120.00/ea
JOR706THS	19mm	\$145.00/ea

Horasley's Trephine

Horasley's Trephine.

JOR161A	Complete, 1/2"	\$52.00/ea
JOR161B	Complete, 3/4"	\$52.00/ea
JOR161C	Complete, 1"	\$52.00/ea

Equine Sinus Trephine

2" The trephine has been designed for use on a modified frontonasal sinus flap surgery.

JOR161E 2" \$145.00/ea **BUY NOW**

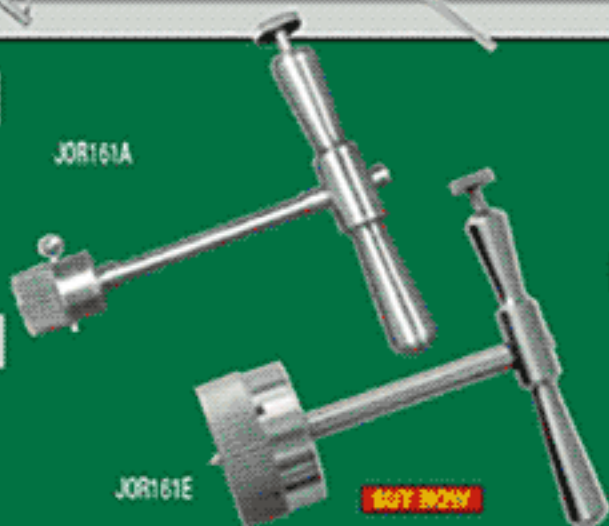

Premium Float Line

These floats are a quality crafted stainless steel float line with many new configurations to employ the newest techniques in equine dental care.

- Flat shaft provides visualization for blade orientation
- Lightweight and precision balanced
- Foam non-slip hand grip, colored coded end
- Large Allen head set screw
- Fits standard flat float blades
- Combined with (JOR57) hardened carbide float blade makes for the finest floating equipment available
- Blade not included **BUY NOW**

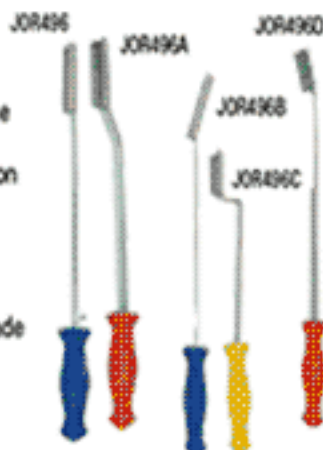

JOR496	Straight molar float 13 1/2"	\$120.00/ea
JOR496A	Excellent for rear molars. 13 1/2" shaft.	\$120.00/ea
JOR496B	Angle or Obtuse Float. For use on upper arcade molars. 11 1/2" shaft.	\$120.00/ea
JOR496C	Premolar Float with short right angle shaft. Especially effective on premolar hooks and special "bit" requirement.	\$120.00/ea

Specially designed for dropping over and onto the last molar and removal of hooks that can develop on the caudal edge of that tooth.

JOR496D Rear Molar Float, 13 1/2" shaft \$120.00/ea

Jorvet Carbide Float Blade

These blades take a lot of the work out of floating a horse's teeth. The carbide metal is very hard and gives a razor sharp edge. This is the new standard in equine dentistry. Blade can be re sharpened 3 times. Available in 3 different grits: fine, medium, and coarse. Medium is the most common grit used. Fits any standard flat headed float. Short Flat Blade for specialized floats (i.e., bit seat float).

JOR57	Medium Grit, 3 1/4" x 1"	\$115.00/ea
JOR57C	Coarse grit, 3 1/4" x 1"	\$116.00/ea
JOR57SF	Fine Grit, 2 1/4" x 1"	\$80.00/ea
JOR57F	Fine Grit, 3 1/4" x 1"	\$102.50/ea
JOR57S	2 1/4" x 1". Medium Grit, Short, Medium, 2 1/4" x 1"	\$98.00/ea



Equivet Carbide Magnetic Float Blade

JOR57XF	Fine	\$73.00/ea
JOR57XM	Medium	\$76.00/ea

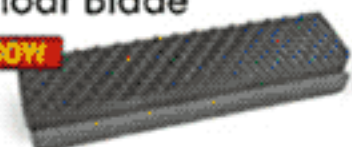

Equivet Floats and Magnets

Equivet Magnet Floats

Flat Float Blade with tungsten carbide chips fits any standard float.

JOR1048A	Upper cheek #8-11	\$110.00/ea
JOR1048B	Lower Cheek #6-11	\$110.00/ea
JOR1048C	Upper and Lower Last Molar #1	\$110.00/ea
JOR1048D	Upper and Lower Tooth Molar #6 or pre-molar roller for creating a bite	\$110.00/ea
JOR1048E	Upper Premolar #6-8	\$110.00/ea
JOR1048F	Up and Lower Incisors #1-4	\$110.00/ea
JOR1048G	Convex float for occlusive surface	\$110.00/ea
JOR57Y	Carbide blade for JOR1048g	\$145.00/ea
JOR57XM	Medium	\$76.00/ea
JOR57XF	Fine	\$73.00/ea

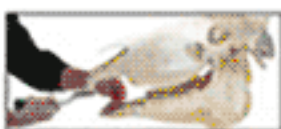

JOR1048F

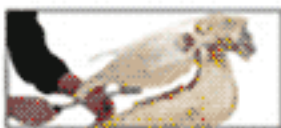

JOR1048E

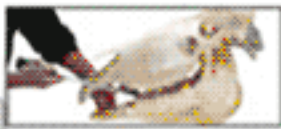

JOR1048E

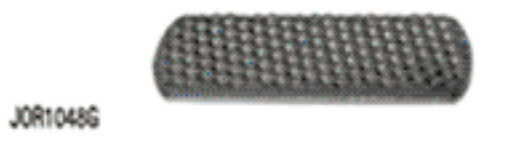
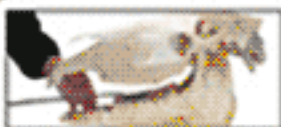

JOR1048G

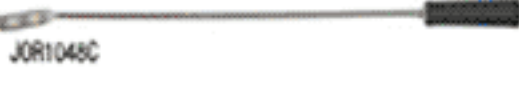
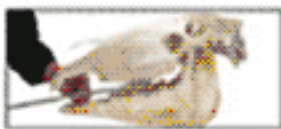

JOR1048C

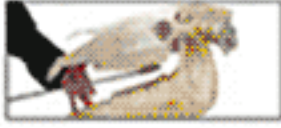

JOR1048A

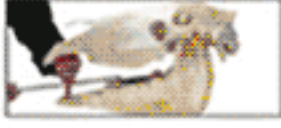

JOR1048B

House Combination Dental Float

House Float Straight Shaft only.

JOR58HS Straight Shaft, Less Blade \$18.00/ea



JOR58HS

BUY NOW

Proctor Float

Proctor Float makes it easy to float the first two premolars. Tungsten carbide chips.

JOR58P 12" L \$39.00/ea

BUY NOW

JOR58P

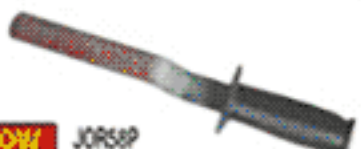

Dental Float w/Pistol-Grip

BUY NOW

Holds dental burrs into a convenient and easy to see block. The magnetic base holds up to 14 burrs securely. Drain holes prevent rusting. Non-slip feet add stability. Autoclavable. Cover sold separately.

Rasps, Straight - Complete

JOR935	Rasp, Straight Head, 30cm	\$152.00/ea
JOR935A	Rasp, Straight Head, 42cm	\$158.00/ea
JOR935H	Straight Float Head for Pistol-Grip Float	\$85.00/ea

Rasps, Angled-Up Head - Complete

JOR936	Rasp, Angled-Up Head 30cm	\$152.00/ea
JOR936A	Rasp, Angled-Up Head 42cm	\$158.00/ea
JOR936H	Replacement Angled-Up Rasp Head only. 1" W x 2"	\$76.00/ea

Rasp, Angled-Down Head - Complete

JOR937	Rasp, Angled-Down head 30cm	\$152.00/ea
JOR937A	Rasp, Angled-Down head 42cm	\$158.00/ea
JOR937H	Replacement Angled-Down Rasp Head, 1" W x 1 3/4" L.	\$86.00/ea
JOR937S	Contains JOR937H and JOR937x Angled-Up, and Angled-Down 30cm Rasps, Six different configurations, with both lengths of pistol grip shafts.	\$386.00/ea

Dental Float w/Pistol-Grip

BUY NOW

JOR937X Pistol grip handle only, 30cm \$76.00/ea
 JOR937Y Pistol grip handle, 42cm \$82.00/ea



House Combination Dental Floats

BUY NOW

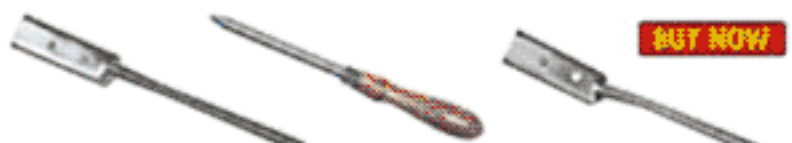

JOR58HC Standard Dental Float with both straight and angled shaft with one interchangeable handle. 20" L. \$54.00/ea
 JOR58HS Straight shaft, less blade \$18.00/ea
 JOR58HA House Float Angle Shaft only. \$18.00/ea
 JOR58HH House Float Interchangeable Handle only \$21.00/ea
 JOR58HQ Float with handle and Straight Shaft. \$36.00/ea
 JOR58HZ Float handle with Angle Shaft. \$36.00/ea

Thomsen's Universal Dental Float

BUY NOW

Float head is hinge attached, making this float universal for upper and lower molars. Float blade is concave from side to side, stays on dental surface. Long lasting tungsten carbide blade.

JOR58CT Curved Float Blade with tungsten carbide chips, fits universal float. \$24.90/ea
 JOR58L 26" \$64.50/ea
 JOR58S 20" \$60.00/ea



Flat Float Blade (Tungsten Carbide)

BUY NOW

Flat Float Blade with tungsten carbide chips fits any standard float.

JOR58FT 1" x 3 1/4" \$19.10/ea

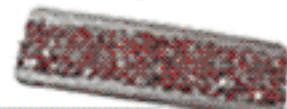

Large Animal Supplies

Retractor, & Ejaculator/Semen Supplies

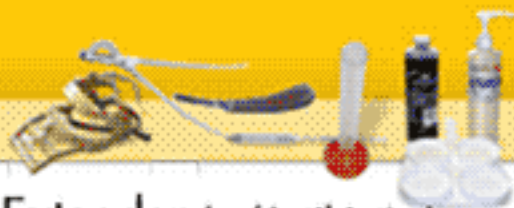

The Lone Star Veterinary Retractor System

BUY NOW

The Lone Star Veterinary Retractor System consists of two components, the autoclavable plastic ring and the accessory elastic stays. Because of its unique design, the retractor ring easily can be adapted to the patient's anatomy. The elastic stays allow the surgeon flexibility over the amount of tension applied and precise retraction of the incision without obstruction. Prep and drape patient in usual manner, then apply the retractor.

JOR4407 Retractor Ring Only, Small \$132.00/ea



Killian Speculum

BUY NOW

Killian Vaginal Speculum for dogs. Has set screw and 3 1/2" blades. Stainless steel.

JOR52K \$19.50/ea



Equine Eye Lid Speculum

BUY NOW

JOR68EE \$53.00/ea



Graefe Eyelid Speculum

BUY NOW

JOR68GW German \$54.00/ea



Polansky Speculum

BUY NOW

Polansky Vaginal Speculum with 3 blades. Has butterfly screw with 2 blades on top for wide exposure. 26cm (10 1/2").

JOR52P 3 blades, 11" \$92.00/ea



Thoroughbred Speculum

JOR52T 28cm (11") \$70.00/ea

Thumb Speculum

JOR700 \$66.00/ea

Jorvet Equine Chain Twitch

Chain twitch with plated chain with 25" flat wooden handle.

JOR44A 5" dia loop \$32.50/ea

BUY NOW



Equine Semen Extender (w/Antibiotics)

This is the all natural product of glucose and non-fat dry milk. It is recommended for all artificial insemination purposes. The semen may be cooled for extended storage periods for transport. It may also be used for same day breeding on the farm with or without antibiotics. Each kit contains the component parts in a hermetically sealed pouch and a separate 150ml wide-mouth bottle of sterile water.

JOR1240 Amikacin and K-Penn. 10 kits/box. \$91.00/pk



Semen Extender (w/o Antibiotics)

JOR124V 10-pk \$73.00/pk

Jorvet

BUY NOW

Dr. Kenney Stallion Semen Ext. (w/antibiotics)

(w/antibiotics) Amikacin and K-Penn. 150 ml dose - Includes water and dry components pouch.

JOR124T 10 units. \$92.50/ea

JOR124S 10 units. \$79.40/ea

BUY NOW



Equine Express Semen Transport Case

BUY NOW

Transporting cooled stallion semen across long distances has been made possible by special transport shippers. This shipper has a cardboard outer shell with 2" thick Styrofoam liner. A special coolant pack is included along with two non-spermicidal 50cc syringes. The package has been approved by both FedEx and UPS. It also is a USDA-APHIS approved container for biological material.



JOR125 14" x 8" x 10". 31/2 lbs. \$54.00/ea

13822 WEST BOULTON BLVD. METAWA, IL 60045

WWW.SHOPMEDVET.COM

Phone 800-544-7521

Fax 800-204-2177

Drenchers/Feeders & Infusion Pumps

Jorvet Drencher

BUY NOW

These drenchers allow for administration of large doses often necessary to treat adult cattle. The use of oral calcium or propylene glycol drenches are easier with large drencher.

- Curved nozzle with olive tip
- Clear barrel to see medication
- High-impact plastic handle

JOR640 300 ml \$84.00/ea



Drencher (Barrel only)

JOR640D2 300cc barrel only \$25.00/ea

Drencher (O Ring Only)

JOR640D1 O ring for 300 ml \$4.80/ea

Drencher (Barrel Only)

JOR641D2 Barrel only 200ml. \$19.00/ea

Drencher (O ring Only)

JOR641D1 "O" Ring for 200ml. \$4.50/ea

Drencher (Piston only)

JOR641D5 Piston for 200 ml \$9.00/ea



Jorvet Bovi-Vet Calf Drencher

A safe and quick method for oral liquid therapy in calves.

JOR137M 2-liter container \$24.60/ea

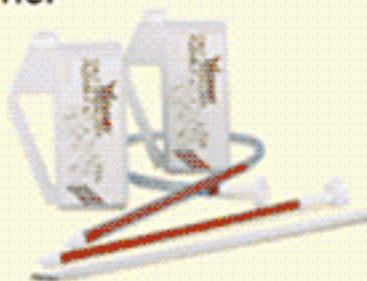

Jorvet Oral Calf Drencher

BUY NOW

Unit Measurements in ml., cc., Pints & Ounces Left-Hand Side Measurement for Hanging Up Right-Hand Side Measurement for Stand Alone

JOR138GB Stainless Steel Esophageal Probe \$18.00/ea

JOR138CP Stainless steel esophageal probe with a rounded end cap. \$18.00/ea

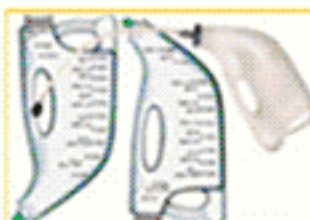

Speedy Feeder Speedy Calf Feeder

Three-speed calf bottle was developed in New Zealand and is widely sold worldwide. It is especially useful for weak or premature calves that cannot nurse properly. The Speedy Calf feeder features: simple switch had 3 "speeds" to adjust flow, x-fast for aggressive nursers, x-slow for oak calves, easygrip can be used comfortably in several positions, cap mounted low to help empty bottle completely, wide 3" diameter neck for easier filling and cleaning, capacity of 2.5 liters, wide base lets bottle stand easy.

JOR1022 \$28.50/ea



Oral Calf Feeder

BUY NOW

This familiar style of semi-rigid container has a screw-on cap with a plastic esophageal probe with a rounded end cap. Measurements are marked on the container.

JOR138C Semi-Rigid, Holds 3 Pints \$9.00/ea

JOR138CP Stainless steel esophageal probe with a rounded end cap. \$18.00/ea

Large 1 gallon container. Plastic esophageal probe style same as JOR138c. Added air vent.

JOR138G 1 gallon \$12.60/ea



Pump (only for Flux Rumen Kit)

Selekt Cattle Pump is a newly developed and field tested stomach pump from Denmark. This new pump allows large volumes (1 1/2 gallon) of fluids to be administered safely by one person in just two minutes. The Selekt pump has a large oral tube (3.25m) that passes deep into the esophagus to avoid placement errors. A heavy-duty outer tube that the cow can chew on protects the wire-reinforced tube. An attached nasal tong helps hold the tube in position while pumping. The lightweight plastic pump is placed into a 5-gallon bucket (not included). A heavy-duty quick release system links the pump to the stomach tube. Instructional CD is available.

JOR901P \$140.00/ea



Calf Nipple (with Cap)

This red rubber nipple attaches to the JOR138c oral calf feeder bottle.

JOR138N Attaches to the JOR138c \$1.28/ea



Equine Uterine Infusion Pipette w/adaptor

An equine specific 25" pipette with extra-large bore adaptor to allow quick-infusion. Individually wrapped. Sterile. 25/case. (Syringe not included.)

JOR284 25", 25pk \$18.75/pk



Probang with Extractor

JOR120 64", For removal of Beets from Bovine esophagus For removal of Beets from Bovine esophagus \$362.00/ea

BUY NOW

Large Animal Supplies

Pumps, Prods & Rings/Leads

Enema or Oral Calf Feeder Bag

This bag was originally developed for enemas on larger patients. It has also found use as an oral calf feeder. Plus, it is less expensive. Short rigid end probe: helps ease passage. Round probe end with side port: helps prevent occlusion.

JOR139 3000 cc capacity \$6.60/ea

BUY NOW

NEW

JorVet Thirsty Stomach Pump

The pump is very lightweight plastic, but durable for all weather use. The "Thirsty" pump has a stroke volume of eight ounces and delivers fluid on both up and down

strokes. The pump has two adaptors for stomach tube attachments. The smaller adaptor attaches foal and small tubes. The larger adaptor attaches medium and large stomach tubes.

JOR136 \$51.90/ea

BUY NOW

Drench Pump

Drench Pump for administering large doses of fluid orally. A continuous flow pump that puts out liquid on both the up and down stroke.

JOR132 Pump \$75.00/ea

JOR132D1 Felt Washer \$3.00/ea

JOR132D2 Rubber O-Ring \$2.70/ea

JOR132W Leather Washer, Pair (washer only) \$18.00/pr

BUY NOW

Barne's Dehorner

Heavy-duty dehorner. Steel handles with rubber grips. Heat-treated steel cutting blades.

JOR182 Wooden Handle, 12" \$33.00/ea

JOR182M Metal Handle, 17" \$48.90/ea

BUY NOW

Tube Dehorner

JOR295C 1" O.D. \$10.50/ea

JOR295A 3/4" \$7.50/ea

JOR295B 7/8" \$9.00/ea

BUY NOW

BUY NOW

Hauptner Clipper

Large animal. For clipping when no electricity is available.

JOR59 \$78.00/ea

Extra Blades for Hauptner Hand Clipper.

JOR590 \$42.00/pr

BUY NOW

Sheep Hand Shearer

Sheep trimming shears. Red enameled handles.

JOR360 6" blades. \$22.20/ea

BUY NOW

Jorvet Prod with Batteries

This is the popular Dutch prod; a sturdy prod with a strong shock.

JOR1 Includes 2 "D" batteries. 9"L. \$72.00/ea

BUY NOW

Jorvet Prod Extension Handle

Extension Handle for electric shocker (JOR1).

JOR1E Extends total length to 36". \$27.00/ea

BUY NOW

Rumen Magnets

This traditional style is solid metal with rounded ends. Features a polished metal finish with slightly roughened ends. Alnico style.

JOR309H 3"L, 12/box. \$45.00/dz

Rectangle Magnet with rounded beveled edges. A coat of nylon plastic covers an inner ceramic magnet. The most powerful magnet offered. It will pick up 25 percent more nails than other designs.

JOR309K 3"L, 12/box. \$21.60/dz

BUY NOW

Bull Lead (with Chain, No Hooks)

JOR178B With chain, No hooks. \$27.00/ea

(without Chain or Hooks)

JOR178AB Without Chain or Hooks. \$21.90/ea

Bull Ring

2 1/2" i.d. This new polished steel bull ring is much stronger than brass. The special sharp cutting points pierce the nasal septum easily with no pre-incision. Screw and screwdriver combined. Break screwdriver off after insertion.

JOR3 Steel, 3", 2 1/2" i.d. \$6.30/ea

JOR3C Copper-Brass, 3" \$6.90/ea

Harm's Bull Lead

JOR178H Overall 10", Stainless steel \$19.50/ea

Bull Lead

Spring-loaded lead closes in animal's nose. Useful in moving or transport of animal. Nose piece measures 2" x 3" across center dia.

JOR178 Overall 5" \$18.00/ea

BUY NOW

Large Animal Supplies

Dental Forceps, Extractors & Elevators

Equine Molar Forcep

Designed by Dr. Seltzer. High-quality. German-made.
JOR43 Stainless steel. 17 1/2" \$90.00/ea



BUY NOW

Equine Universal Dental Extraction Forceps

JOR706U \$657.00/ea



BUY NOW

EquiVet Cap Forceps w/Flexible Head

EquiVet Cap Forceps with flexible head. This cap retained deciduous teeth removal forceps gives a better grip as the heads swivel to fit the actual shapes of the cap. Universal for both upper and lower jaws.

JOR43X Stainless Steel. \$211.00/ea



BUY NOW

Deciduous Incisor Tooth Extractor

Spring handle increases holding power. Stainless Steel.
JOR703 20cm L. \$552.00/ea



BUY NOW

Deciduous Incisor Tooth Extraction Forceps

Deciduous Premolar "Cap" Extraction Forceps. Designed by Dr. Stelzer, German-made high quality forceps. Slightly curved.

JOR704 Stainless steel. 17"L. \$550.00/ea



BUY NOW

Reynold's Equine Tooth Extractor

This is the recommended instrument for retained deciduous teeth (caps) in horses. Also works for small premolars and incisors.

JOR43RU Upper Jaw. Stainless steel. 15"L (38cm). \$94.00/ea

JOR43RL Lower Jaw. Stainless steel. 15"L (38cm). \$94.00/ea



BUY NOW

Extraction Forceps

Universal Small Tooth Extracting Forceps.

JOR705 Stainless steel. 17"L. \$564.00/ea



EquiVet Dental Irrigation Pick

This specially designed dental pick uses pressurized water irrigation through a long thin metal tube with a right angle end. Very useful in cleaning of inter-dental spaces and periodontal pockets. Connects to a water tank that, with a few simple pumps, creates a pressurized flow.

JOR939X \$224.00/ea



BUY NOW

Equine Dental Fulcrum

Use as a fulcrum to gain leverage in conjunction with a molar extraction forceps when extracting large cheek teeth.

JOR705F Dual End. 22" (54cm) L. \$238.00/ea



BUY NOW

EquiVet Dental Mirror

Large mirror angled at 30°. "T" shaped handle.
JOR938M 19" length \$70.00/ea

BUY NOW

S-Floted Hand Rasp

"S"-Shaped Hand Rasp. This is especially useful as a finishing tool on the upper premolars.

JOR702 Tungsten carbide. 30cm L. \$105.00/ea

BUY NOW

Premium Float Line

These floats are a quality crafted stainless steel float line with many new configurations to employ the newest techniques in equine dental care.

- Flat shaft provides visualization for blade orientation
- Lightweight and precision balanced
- Foam non-slip hand grip, colored coded end
- Large Allen head set screw
- Fits standard flat float blades
- Combined with (JOR57) hardened carbide float blade makes for the finest floating equipment available
- Blade not included

BUY NOW

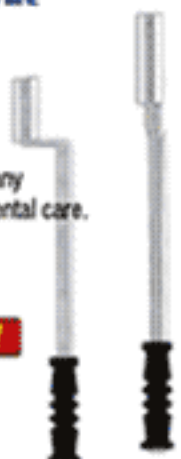

- | | | |
|---------|--|-------------|
| JOR496 | Straight molar float 13 1/2" | \$120.00/ea |
| JOR496A | Premium Float Line, 13 1/2" shaft. | \$120.00/ea |
| JOR496B | Angle or Obtuse Float. For use on upper arcade molars. 11 1/2" shaft. | \$120.00/ea |
| JOR496C | Premolar Float with short right angle shaft. Especially effective on premolar hooks and special "bit" requirement. | \$120.00/ea |

Specially designed for dropping over and onto the last molar and removal of hooks that can develop on the caudal edge of that tooth.

JOR496D Rear molar float, 13 1/2"L shaft \$120.00/ea

EquiVet Dental Rasps Protector

Designed to fit or be inserted into JOR398b stainless steel bucket. Separates and protects rasps while soaking in the bucket.

JOR496DRP \$77.00/ea

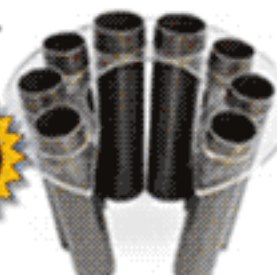

BUY NOW

Dental Floats

Thomsen's Universal Dental Float **BUY NOW**

Float head is hinge attached, making this float universal for upper and lower molars. Float blade is concave from side to side, stays on dental surface. Long lasting tungsten carbide blade.

JOR58CT	Curved Float Blade with tungsten carbide chips, fits universal float.	\$24.90/ea
JOR58L	26"	\$64.50/ea
JOR58S	20"	\$60.00/ea



Flat Float Blade (Tungsten Carbide) **BUY NOW**

Flat Float Blade with tungsten carbide chips fits any standard float.

JOR58FT	1" x 3 1/4"	\$19.10/ea
---------	-------------	------------

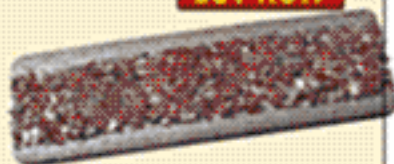

Proctor Float

Proctor Float makes it easy to float the first two premolars. Tungsten carbide chips.

JOR58P	12" L	\$39.00/ea
--------	-------	------------



Short Flat Float Blade

JOR57SF	Fine Grit, 2 1/4" x 1".	\$80.00/ea
JOR57S	2 1/4" x 1". Medium Grit, Short, Medium, 2 1/4" x 1".	\$98.00/ea



Convex Blade for JOR1048G only

JOR57Y	Carbide Blade for JOR1048G	\$145.00/ea
--------	----------------------------	-------------

T-Handle Blade Punch

JOR1048T	\$30.00/ea
----------	------------



Equivet Magnet Floats **BUY NOW**

A totally new approach to a float blade attachment to the handle. These floats have a magnetic head that holds securely, the solid carbide blade. The blades can be removed with a "T" bar handle punch. The blades are a very sharp solid carbide with rounded corners. Hollow shaft lightens weight. The shaft is flattened at its attachment to the handle. This gives the operator orientation on the blade location.

JOR1048A	Upper cheek #8-11	\$110.00/ea
JOR1048B	Lower Cheek #6-11	\$110.00/ea
JOR1048C	Upper and Lower Last Molar #1	\$110.00/ea
JOR1048D	Upper and Lower Tooth Molar #6 or pre-molar roller for creating a bitseat	\$110.00/ea
JOR1048E	Upper Premolar #6-8	\$110.00/ea
JOR1048F	Up and Lower Incisors #1-4	\$110.00/ea
JOR1048G	Convex float for occlusive surface	\$110.00/ea

JOR1048 Series



Equivet Carbide Magnetic Float Blade

These blades are a very sharp solid carbide with rounded corners. Hollow shaft lightens weight. The shaft is flattened at its attachment to the handle. This gives the operator orientation on the blade location.

JOR57XF	Fine	\$73.00/ea
JOR57XM	Medium	\$76.00/ea



House Combination Dental Float

JOR58HA	House Float Angle Shaft only.	\$18.00/ea
JOR58HS	Straight Shaft, Less Blade	\$18.00/ea
JOR58HZ	Float handle with Angle Shaft.	\$36.00/ea
JOR58HQ	Float with handle and Straight Shaft.	\$36.00/ea
JOR58HH	House Float Interchangeable Handle only	\$21.00/ea
JOR58HC	Standard Dental Float with both straight and angled shaft with one interchangeable handle. 20" L.	\$54.00/ea

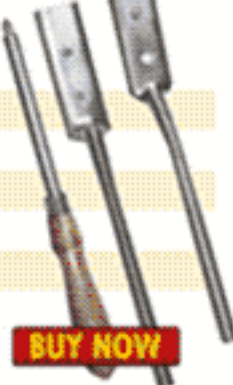

Dental Float w/Pistol-Grip **BUY NOW**

JOR935	Rasp, Straight Head, 30cm	\$152.00/ea
JOR935A	Rasp, Straight Head, 42cm	\$158.00/ea
JOR935H	Straight Float Head for Pistol-Grip Float	\$85.00/ea
JOR936	Rasp, Angled-Up Head 30cm	\$152.00/ea
JOR936A	Rasp, Angled-Up Head 42cm	\$158.00/ea
JOR936H	Replacement Angled-Up Rasp Head only. 1" W x 2"	\$76.00/ea
JOR937	Rasp, Angled-Down head 30cm	\$152.00/ea
JOR937A	Rasp, Angled-Down head 42cm	\$158.00/ea
JOR937H	Replacement Angled-Down Rasp Head, 1" W x 1 3/4" L.	\$86.00/ea
JOR937S	Contains JOR937H and JOR937x Angled-Up, and Angled-Down 30cm Rasps, Six different configurations, with both lengths of pistol grip shafts.	\$386.00/ea
JOR937X	Pistol grip handle only, 30cm	\$76.00/ea
JOR937Y	Pistol grip handle, 42cm	\$82.00/ea

Carbide Float Blade **BUY NOW**

These blades take a lot of the work out of floating a horse's teeth. The carbide metal is very hard and gives a razor sharp edge. This is the new standard in equine dentistry. Blade can be resharpened 3 times. Available in 3 different grits: fine, medium, and coarse. Medium is the most common grit used. Fits any standard flat headed float. Short Flat Blade for specialized floats (i.e., bit seat float).

JOR57C	Coarse grit, 3 1/4" x 1".	\$116.00/ea
JOR57	Medium Grit, 3 1/4" x 1".	\$115.00/ea
JOR57F	Fine Grit, 3 1/4" x 1".	\$102.50/ea



Large Animal Supplies

Large Animal Dental

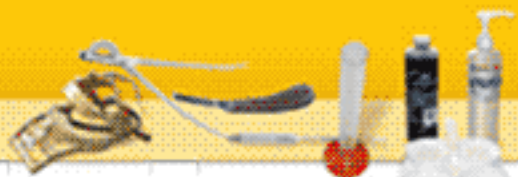

Jorvet Equine Speculum Dental Light

The Equivet dental light attaches to any brand of full mouth speculum using incisor plates (i.e., McPherson and McPherson). This light is designed to illuminate the entire dental arcade. Its small "AAA" battery pack attaches right to the speculum and avoids any long hanging wires.

JOR38X \$129.00/ea



BUY NOW



Deluxe Wolf Tooth Elevator

JOR709 with Ergonomic Handle, 22cm L. \$99.00/ea



BUY NOW

Double End Elevator 4mm

JOR42Y Stainless Steel Knurled 7 1/4" L handle. \$33.00/ea



BUY NOW

EquiVet Dental Pick

JOR339 Stainless Steel, Sharp, 19", 48cm \$54.00/ea



BUY NOW

EquiVet Parallel Gingival Elevator

Useful for exploring and elevating between teeth. "T" handle.

JOR339B Stainless Steel, 19", 48cm, Parallel \$57.00/ea

JOR339A Stainless Steel, 19", 48cm, Perpendicular \$57.00/ea



BUY NOW



Fetal Extractor

BUY NOW

This calf puller provides an entirely new approach to difficult calvings. With one of the handles you can move the two separate hooks alternately, pulling first one limb and then, with the next movement of the handle, the other limb. The most difficult presentation can be zig-zagged out in this manner. The extra-long 65" no-slip shaft disassembles in the middle. Breech is supplied with an adjustable, easy-to-clean chain.

JOR99 \$198.00/ea



Economy Calf Puller

This unit has a design similar to the Hercules calf puller, but costs considerably less.

JOR99E \$138.00/ea **BUY NOW**

Calf puller carry case

JOR99C \$17.85/ea **BUY NOW**



Roaring Burr (French)

For use in equine laryngeal hemiplegia (roaring). French model with hooks.

JOR62S 8 1/2"L. \$18.90/ea

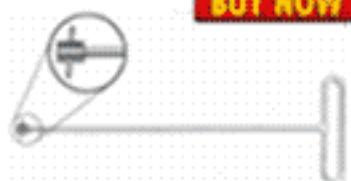

BUY NOW

Soft Tissue Protector

Soft Tissue Protector. Fits polishing head of a dental unit.

JOR41ST \$105.00/ea

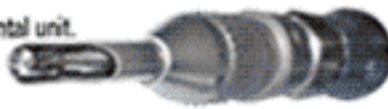

BUY NOW

Diamond Disc Safety Shield

Diamond Disc Safety Shield.

JOR41SS Safety shield only \$105.00/ea



BUY NOW

Equine Dental Instruments

BUY NOW

A large dental patient like a horse needs oversized equipment. These dental probes, scalers, and explorers are giant sized to 19" with knurled handles. If you do a lot of equine dentistry, you are going to find them very useful.

- JOR440 Explorer or Shepherd's Hook \$36.00/ea
- JOR440A Sickle Shaped Scaler \$36.00/ea
- JOR440B Sickle Shaped Scaler-Heavy \$36.00/ea
- JOR441 Dental Probe Heavy Tip, Calibrated probe is used to measure depth of periodontal pockets \$47.00/ea
- JOR441A Dental Probe Fine Tip, Finer calibrated tip for pulp horns and tooth surface pockets on the occlusal surface of cheek teeth. \$47.00/ea



Dental Scraper

Dental Scaler, #6. Stainless steel.

JOR42J #6. Stainless steel. 6"L. \$4.50/ea



BUY NOW

Tooth Cutter

BUY NOW

Molar Cutter. The most effective design of a molar cutter has a parallel alignment of the jaws to the tooth surface. This allows the whole tooth to be trimmed, not just at the narrow point of attachment. The jaws of this instrument are a special hardened tempered steel. Knurled handles for a non-slip grip.

JOR708 Angled-56cm \$795.00/ea

JOR707 Straight-56cm \$675.00/ea



Jorvet Tooth Punches

The punch is used for removal of cheek teeth through a trephined hole into the sinus. A knurled handle gives a better grip. A round head with a slight recessed area fits better onto the tooth. Stainless steel.

Tooth Punch-Curved

JOR713 20cm L. \$42.00/ea

Tooth Punch-Straight

JOR712 20cm L. \$43.50/ea



BUY NOW

Large Animal Supplies

Hooks, Colostrometers, Balling Guns & Leg Splints



Krey Hook **BUY NOW**

This double-action OB hook will bite into part of the fetus in the process of doing an embryotomy. Should the instrument slip, the hooks will close automatically and prevent injury.

JOR19 Stainless Steel, 8"L. \$25.50/ea

OB Double Eye Hook **BUY NOW**

JOR19R Very easy to use. 5 1/2"L. \$19.50/ea

OB Wire Guide **BUY NOW**

This instrument will bring your wire around any tight or difficult location on the fetus.

JOR20 7"L. \$8.10/ea

Ostertag Blunt Eye Hook **BUY NOW**

JOR19C Stainless Steel, Hole 5/8" dia. Hook 3/4"L. Total 2"L. \$8.70/ea

Harms OB Hook

Stainless steel. Similar to JOR19c only longer. 4"L.

JOR19HB Blunt End \$12.00/ea
 JOR19HS Sharp \$12.00/ea

Jorvet Equine Colostrometer

The Jorvet Equine Colostrometer utilizes only a small 15ml sample of the mare's colostrum by comparing the specific gravity to distilled water in a plexiglass hydrometer. From the specific gravity obtained, a determination can be made whether or not the foal will be receiving colostrum with adequate IgG concentration. Another benefit is if the colostrum specific gravity is fairly high, up to 250cc can be frozen for a colostrum bank.

JOR281 \$92.50/ea **BUY NOW**

Hydrometer Cylinder

JOR281D2 \$28.50/ea

Jorvet Bovine Colostrometer

The Jorvet colostrometer measures IgG content in a simple cowside test. The graduated cylinder is filled with a few ounces of Bovine colostrum. The colostrometer is gently inserted and floats to a level indicating the colostrum IgG content. A University of Florida study found only 20 percent of colostrum contained an adequate amount of IgG for good calf health.

JOR349 Plastic \$57.00/ea

Colostrum-Plus

- Now USDA approved for protection against E-Coli, K-99 antigen
- USDA approved for failure of passive transfer
- Still real colostrum. Not a substitute like cheese whey or blood plasma
- Powder form in foil-lined pouch of 350 gm
- Now with 3-year dating
- Detailed literature upon request
- 12 pk/display box

JOR330EC Dozen \$132.00/dz

Cow Plastic Balling Gun (Red) **BUY NOW**

Balling Gun. Cow. 7/8" dia. head. Red.
 JOR794 17 1/2"L. \$2.10/ea

Calf Plastic Balling Gun (Blue) **BUY NOW**

Balling Gun. Calf. 5/8" dia. head.
 JOR793 Blue, 13 1/2"L. \$1.50/ea

Calf Plastic Balling Gun w/grooved head (white) **BUY NOW**

Balling Gun. Calf, with ribbed 5/8" dia. head. White.
 JOR793A 5/8" dia. head. White. \$1.65/ea

Jorvet LePill Balling Gun **BUY NOW**

Le Pills are a family of extra large boluses that were developed in cooperation with research conducted at a European veterinary school. Drench and paste use can be dangerous if not properly administered. These boluses are large, but easily dissolved. There is a series of three different formulated boluses for the variety of metabolic conditions encountered in today's high productivity dairy cow. Each tablet is packaged individually in a plastic tube. LePills Balling Gun is especially designed for the large oversize boluses listed above. It has a slightly angled shaft with a wide trigger, and is one of the safest and sturdiest balling guns made.

JOR901B \$68.00/ea

BUY NOW

Jorvet Multi-dose Balling Gun **BUY NOW**

- Simplest design for ease of administration
- High impact PVC tube that resists biting
- Holds enough boluses of any size for any procedure
- Lightweight, only 1.5 lbs.
- Field-tested for over 5 years at some of the country's largest feed yards

JOR185M Holds up to six full-size boluses. 7/8" dia. \$37.50/ea
 JOR185MS Holds up to five calf-size boluses. 5/8" dia. Blue handle. \$22.50/ea

BUY NOW

"Bos" Lower Leg Splint

A heavy-duty reinforced rigid PVC splint with closed-cell foam lining. Especially designed for use in larger animals with flexor tendon or lower leg nerve injuries. Placed on the back of the leg and held in place with bandage material (not included).

JOR927 Calf. Green, hindleg. 40cm. \$49.00/ea
 JOR927A Cow. Small. Blue. 47cm. \$48.00/ea
 JOR927B Cow. Large. Orange. 51cm. \$45.00/ea
 JOR927C Cow. XL (Purple) 54cm. \$48.00/ea
 JOR927E Calf. Front leg (Yellow) \$51.00/ea

BUY NOW

Large Animal Supplies

Mastitis, Equine Recovery Hoods & CMT Tests

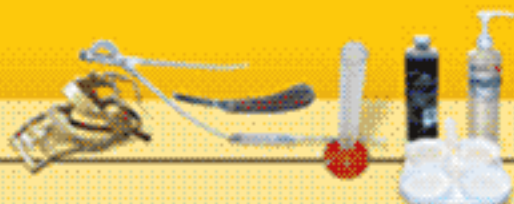

Jorvet Mastitis Test X-purt

CMT can now be done with a one-hand operation. The 300ml X-purt reagent reservoirs (10 oz) acts as a handle. Milk is put in each paddle chamber (about 3ml or 0.1 oz). A quick squirt of reservoirs inputs equal amounts of test solution into each chamber. Swirling for usual coagulation recognition. Color Chart included. Reservoir bottle capacity will test about 15 cows.

JOR370X Just refill from CMT liquid (JOR370L). \$22.50/ea



Mastitis Indicator Jorvet

Jorvet Mastitis Indicators. Color indicator test sheets for mastitis infections. Simple and safe to use. One colored square for each udder quarter.

JOR370M 25-pack \$5.70/pk

Chain Ecrasseur

This is the popular ratchet type ecrasseur by Chassignac. Stainless Steel.

JOR37E German-made. 19". \$450.00/ea



Colorado Style Equine AV

This is a lightweight A.V. in a complete kit with natural latex liners and plastic disposable liner. Also has collection bottle and filter. Comes with complete instruction manual. Many parts will interchange with other CSU or Colorado A.V.'s. Detailed literature upon request.

JOR125AV \$595.00/ea

Latex Collection Liner

JOR125AVD2 Latex Inner Rubber \$44.00/ea
 JOR125AVD1 Latex Collection Liner \$45.50/ea

Disposable Plastic Liner

Disposable Plastic Liner. 25/pk.
 JOR125AVD3 25 pk. \$34.50/ea



Equine Padded Recovery Hood

This protective hood is a valuable tool in the prevention of head trauma such as facial nerve paralysis, to any horse undergoing anesthesia. The thick yellow closed-cell foam padding has openings for eyes, ears, and muzzles. The area around the eyes is double padded.

JOR473	Neonatal foal hood	\$140.00/ea
JOR473A	Foal/yearling hood	\$162.00/ea
JOR473B	Standard hood	\$189.00/ea
JOR473C	Warm blood/draft hood	\$198.00/ea

Repair Sealant

JOR473RP Equine Padded Recovery Hood repair sealant, 3 oz. \$19.50/ea



Jorvet Calf Snare

Calf Snare (Cable type). Useful in difficult calvings for pulling a retracted head forward or from preventing the head from turning back during delivery.

JOR99S 26"L \$33.00/ea

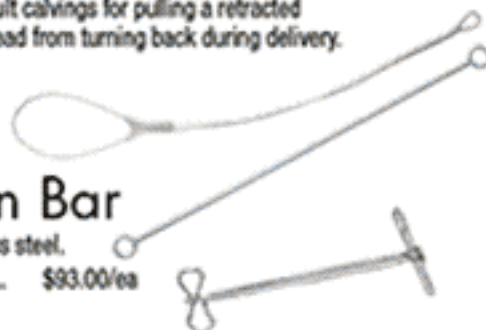

Jorvet Detorsion Bar

Used in bovine uterine torsion. Stainless steel.

JOR121 (chain not included) 31 1/2"L. \$93.00/ea

BUY NOW

Jorvet CMT Test Kit

Jorvet offers an introductory kit for mastitis detection and control. The CMT measures somatic cell counts through a special reagent in a four-chambered paddle. Kit includes: Paddle, 0.5-liter empty pump bottle, 1-pint concentrated CMT liquid, and directions with color charts.

JOR370K \$22.50/ea

CMT Paddle

JOR370P \$7.50/ea

CMT Test Liquid

CMT Test Liquid. 1-pint concentrate makes 1 gallon.
 JOR370L Concentrate, 1 Gallon \$15.75/ea



Jorvet Squeeze Jet

The Jorvet Squeeze Jet is clear for easier identification of medicines being dispensed. 30ml. Economically packaged 500/pk. or 1000/pk. Tips and caps come 500/bag.

JOR122B	clear 1000 pack	\$305.00/pk
JOR122A	clear, 500 pack	\$160.00/pk
JOR122C	Empty Carton, holds 12.	\$1.50/ea
JOR122CA	Clear, Dozen Pack	\$8.10/dz

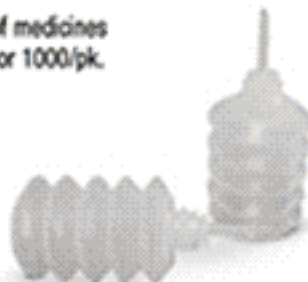

Jorvet Bovine Hobble Strap

These wide heavy-duty nylon straps are the perfect aid in giving support to cows showing the effects of obturator paralysis.

JOR201 \$45.00/ea

BUY NOW



Large Animal Supplies

Large Animal Syringes

Henke Roux Revolver

A high-quality precision-made revolver syringe. Of German origin it's known for its accuracy. Dosage is set by turning the dosage setting wheel at the rear of the barrel. For long-lasting dependability, durability and accuracy, buy the "HENKE" Roux.

JORS53H 50cc, adjusts 1, 2, 3, 4 & 5cc.
 JORS53HB Henke Roux. 10cc, adjusts to 1/4, 1/2 & 1cc.

\$57.00
 \$57.00

BUY NOW

Henke Roux Revolver Parts

JORS3012	Cap for #11 spring	\$0.60
JORS3018	Compression spring	\$0.45
JORS3044	Compression spring	\$2.10
JORS3031B	Disc for piston, 10cc	\$3.30
JORS3031	Disc for piston, 30cc & 50cc	\$1.65
JORS3020B	Dosage wheel, 10cc	\$6.00
JORS3020	Dosage wheel, 30cc & 50cc	\$6.90
JORS3036	Dosage wheel, 30cc mindose	\$9.00
JORS3024B	Front end with luerlock, 10cc	\$13.50
JORS3024	Front end with luerlock, 30cc & 50cc	\$10.60
JORS3026B	Glass barrel, 10cc	\$3.90
JORS3026A	Glass barrel, 30cc	\$3.90
JORS3013	Gudgeon bolt	\$1.35
JORS307	Handle connecting screw	\$6.15
JORS3055	Henke dosage repair kit (incl 2, 11, 42, 43)	\$7.50
JORS3049	Henke dosage wheel	\$19.50
JORS302	Henke dosage wheel screw	\$1.50
JORS3053	Henke forend handle, complete	\$24.00
JORS3056	Henke plunger rod kit (incl 28, 30, 31, 32, 33)	\$27.00
JORS3051	Henke ratchet clip	\$1.50
JORS3052	Henke ratchet screw	\$1.80
JORS3045	Henke rear handle, complete	\$46.00
JORS3054	Henke Roux repair kit	\$21.00
JORS3026	Glass barrel, 50cc	\$4.20
JORS3042	Henke set screw	\$3.35

JORS3043	Henke steel ball, 4 mm	\$1.80
JORS3028B	Inner rod, 10cc	\$6.00
JORS3028	Inner rod, 50cc	\$7.05
JORS3028A	Inner rod, 30cc	\$7.05
JORS3028B	Inner rod, 10cc	\$7.05
JORS3033	Knurled knob	\$6.00
JORS3028A	Inner rod, 30cc	\$7.05
JORS3028B	Inner rod, 10cc	\$7.05
JORS3027	Plastic barrel with luerlock, 50cc	\$14.70
JORS3027A	Metal frame, 30cc	\$14.70
JORS3027B	Metal frame, 10cc	\$14.40
JORS3037	Outer rod, 30cc mindose	\$4.50
JORS3032	Outer rod, 50cc	\$9.60
JORS3032A	Outer rod, 30cc	\$9.60
JORS3032B	Outer rod, 10cc	\$9.60
JORS3026Q	Plastic barrel, 30cc	\$2.40
JORS3026P	Plastic barrel, 50cc	\$3.90
JORS3026R	Plastic barrel with luerlock, 50cc	\$10.50
JORS3014	Ratchet tip	\$5.55
JORS301B	Rear grip, 10cc	\$33.00
JORS301	Rear grip, 30cc & 50cc	\$36.00
JORS3030B	Rubber piston, 10cc	\$3.00
JORS3030	Rubber piston, 30cc & 50cc	\$1.80
JORS3035	Spring for handles	\$3.90
JORS3025B	Washer set, 10cc	\$3.30
JORS3025	Washer set, 30cc & 50cc	\$3.30

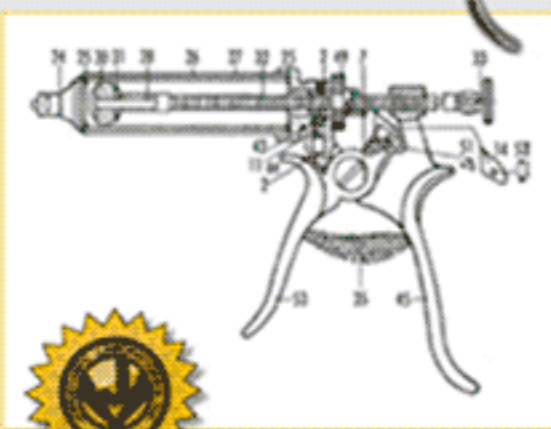

Ferromatic Automatic Syringe

BUY NOW

Unique design has dosage adjustments from .5ml to 5.0ml. Fits bottle tops from 30ml-120ml.

Features:

- One-piece front end with luer lock
- A valve accessory allowing user to adapt the syringe for use with a collapsible bottle (part #14c optional)
- Tubing and attachment to allow draw offs from bottles (optional)
- New plastic valve system to prevent valve "swelling"

JORS3F91 5cc, M91 \$116.00

Ferromatic Automatic Syringe Parts

JORS3FD191	Barrel Frame, M91	\$27.00
JORS3FD21	Closing cap	\$2.70
JORS3FD11	Compression spring	\$3.90
JORS3FD1191	Compression spring, M91	\$3.00
JORS3FD6	Crutch handle	\$3.00
JORS3FD8	Dosing device	\$4.50
JORS3FD891	Dosing device, M91	\$6.00
JORS3FD8M	Dosing device, M96	\$4.50
JORS3FD10M	End washer, M86 & M91	\$1.80
JORS3FD9	Fixing nut	\$2.25
JORS3FD991	Fixing nut, M91	\$2.25
JORS3FD1M	Frame, M86	\$24.00
JORS3FD2291	Front piece, M91	\$34.00
JORS3FD991	Front screw	\$10.50
JORS3FD2M	Sec. M86, M91	\$7.80
JORS3FD7	Guiding cap	\$1.80
JORS3FD791	Guiding cap, M91	\$6.00
JORS3FD7M	Guiding cap, M86	\$1.80
JORS3FD23	Luerlock adaptor	\$4.50
JORS3FD4	O-Ring Washer piston	\$2.40
JORS3FD3	Piston	\$3.30

JORS3FD5M	Piston rod and handle, M86	\$9.00
JORS3FD591	Piston rod and handle, M91	\$10.50
JORS3FD27	Piston rod assembly, 3, 4, 5, 6	\$12.00
JORS3FD391	Piston, M91	\$5.50
JORS3FD2691	Repair kit (4, 10M, 2 of 1291, 1391, 1691)	\$30.00
JORS3FD28	Repair kit (4, 10, 3 of 12, 13, 16, 17, 18, 20, 25)	\$21.60
JORS3FD26M	Repair kit (4, 10M, 3 of 12, 13, 16, 17, 18, 20, 25)	\$21.60
JORS3FD12	Rubber valve*	\$3.00
JORS3FD19M	Screw cap - 07	\$9.00
JORS3FD19	Screw cap	\$4.50
JORS3FD3191	Tubing	\$6.00
JORS3FD3291	Attachment	\$6.00
JORS3FD14C	Valve head, M91, collapsible bottle	\$43.00
JORS3FD14S	Valve head, M91, non-collapsible bottle	\$30.00
JORS3FD15	Valve head screw*	\$3.00
JORS3FD1491	Valve screw	\$6.00
JORS3FD4M	Washer piston	\$1.80

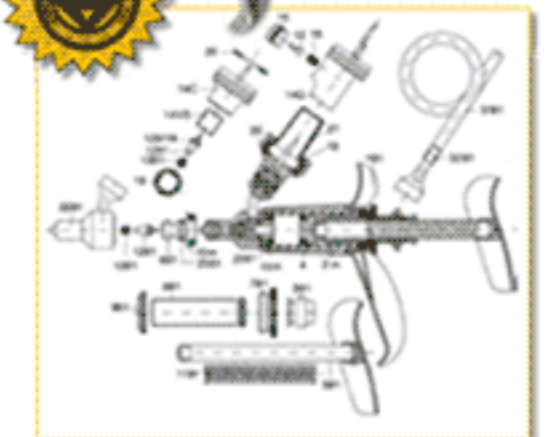

13822 WEST BOULTON BLVD. METAWA, IL 60045

WWW.SHOPMEDVET.COM

Phone 800-544-7521

355

Fax 800-204-2177

Large Animal Supplies

Large Animal Syringes

Hauptner Syringe

Famously accurate and correct dosing.

JOR31A	10cc, adjusts to 1/4, 1/2, 3/4, and 1cc doses.	\$108.00
JOR31B	30cc, adjusts to 1, 2, 3, 4, and 5cc doses.	\$83.00
JOR31C	50cc, adjusts to 1, 2, 3, 4, and 5cc doses.	\$88.35
JOR31E	25cc, adjusts to 1/2, 1, 1 1/2, 2 and 2 1/2. Excellent for injecting homeo®	\$112.50

BUY NOW

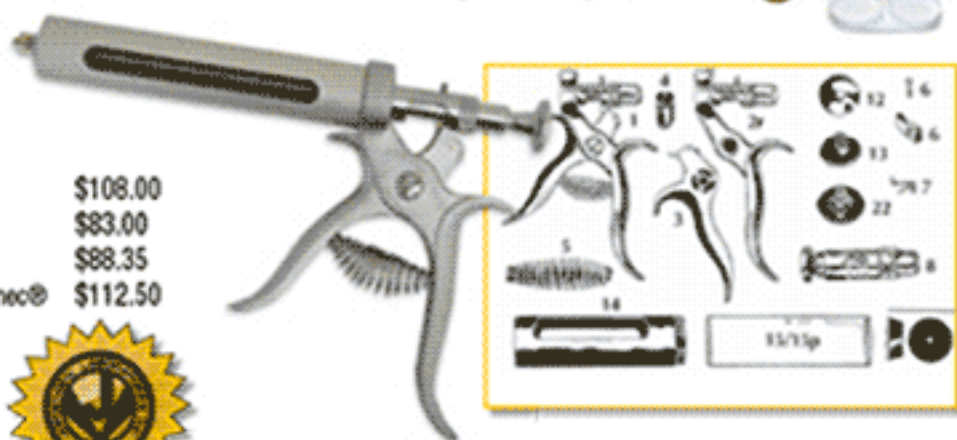

Hauptner Syringe Parts

JOR31TMD	2cc Glass barrel	\$31.00
JOR31D1	Complete grip, 30cc & 50cc	\$66.50
JOR31D1E	Complete grip, 25cc	\$66.50
JOR31D2	Thumb grip less regulator, 30cc & 50cc	\$19.50
JOR31D22	Luerlock with endplate, 30cc & 50cc	\$6.60
JOR31D15A	Glass barrel, 10cc	\$3.90
JOR31D15E	Glass barrel, 25cc	\$3.90
JOR31D15B	Glass barrel, 30cc	\$3.90
JOR31D15C	Glass barrel, 50cc	\$3.90
JOR31D23	HAUPTNER repair kit (incl. 6, 7, 15, 16ml)	\$13.80
JOR31D10A	Inner rod, 10cc	\$8.40
JOR31D10E	Inner rod, 25cc Complete grip, 30cc & 50cc	\$7.50
JOR31D10B	Inner rod, 30cc	\$8.70
JOR31D10C	Inner rod, 50cc	\$7.50
JOR31D22A	Luerlock with endplate, 10cc	\$9.00
JOR31D22E	Luerlock with endplate, 25cc	\$13.50
JOR31D14A	Metal cover, 10cc	\$15.00
JOR31D14E	Metal cover, 25cc	\$21.00
JOR31D14B	Metal cover, 30cc	\$15.00
JOR31D14C	Metal cover, 50cc	\$15.60
JOR31D11A	Outer rod, 10cc	\$9.00

JOR31D11E	Outer rod, 25cc	\$9.00
JOR31D11B	Outer rod, 30cc	\$9.30
JOR31D11C	Outer rod, 50cc	\$8.40
JOR31TBM	Perpendo TB syringe, 2cc	\$129.00
JOR31D14PRE	Platen rubber (only 25cc)	\$1.50
JOR31D15PB	Plastic barrel, 30cc	\$2.40
JOR31D15PC	Plastic barrel, 50cc	\$3.90
JOR31D12A	Plate for plunger, 10cc	\$4.50
JOR31D12E	Plate for plunger, 25cc	\$4.50
JOR31D12	Plate for plunger, 30cc & 50cc	\$2.70
JOR31D1A	Complete grip, 10cc	\$60.00
JOR31D1E	Washer pack set, 30cc & 50cc	\$4.20
JOR31D1B	Washer pack set, 25cc	\$4.50
JOR31D29A	Thumb grip with regulator, 10cc	\$39.00
JOR31D29E	Thumb grip with regulator, 25cc	\$42.00
JOR31D3	Grip with ratchet	\$27.00
JOR31D4	Lock screw	\$1.95
JOR31D9A	Storage regulator, 10cc	\$24.00
JOR31D9E	Complete plunger, 10cc	\$22.80
JOR31D9B	Complete plunger, 30cc	\$24.00
JOR31D9C	Complete plunger, 50cc	\$22.50
JOR31D9E	Complete plunger, 25cc	\$24.00

JOR31D5	Spring for grip	\$1.20
JOR31TBC	TB caliper	\$90.00
JOR31TBN	TB needle	\$12.60
JOR31D13A	Tension screw, 10cc	\$3.90
JOR31D13	Tension screw, 25cc, 30cc, 50cc	\$3.90
JOR31D2A	Thumb grip less regulator, 10cc	\$28.00
JOR31D2	Thumb grip less regulator, 30cc & 50cc	\$19.50
JOR31D16A	Washer pack set, 10cc	\$4.50
JOR31D16E	Washer pack set, 25cc	\$4.50
JOR31D16	Washer pack set, 30cc & 50cc	\$4.20
JOR31D16M	Washer pack set, modified, 30cc & 50cc	\$4.50
JOR31TBM	Perpendo TB syringe, 2cc	\$129.00
JOR31TBN	TB needle	\$12.60

Vetamatic Syringe, 5cc

BUY NOW

A handy, sturdy automatic multidose syringe. Plastic valve and washer reduces swelling problems.

NOTE: Spare Parts Ordering: Parts 13, 1494 and 1694 as shown on parts diagram are not available individually. They can be purchased only as a repair kit J-53vd 2894

JOR53V94	.5ml to 5.0ml	\$84.00/ea
----------	---------------	------------

Vetamatic Syringe Parts

JOR53V94	.5ml to 5.0ml	\$84.00
JOR53VD794	Compression spring	\$2.40
JOR53VD8M	Dosing screw and tube, M88	\$7.50
JOR53VD894	Dosing sheath	\$6.00
JOR53VD24A	Filler needle, 4 3/4"	\$10.50
JOR53VD24B	Filler needle, 7 1/2"	\$19.50
JOR53VD24C	Filler needle, 8 1/2"	\$19.50
JOR53VD994	Fixing nut	\$2.40
JOR53VD1794	Front end	\$18.00
JOR53VD17M	Front end, M96	\$21.00
JOR53VD294	Front screw	\$10.50
JOR53VD4M	Glass barrel, M86 & M91	\$7.80
JOR53VD1M	Metal frame	\$27.00
JOR53VD1294	Platen	\$4.50
JOR53VD594	Platen rod	\$28.00

JOR53VD2894	Repair kit (2 each of 13, 1494, 1694)	\$21.00
JOR53VD28	Repair kit (3, 11, 13, 2 of 14, 15, 16, 18)	\$18.00
JOR53VD28M	Repair kit M96 (3m, 13, 2 of 14, 15, 16, 18)	\$19.50
JOR53VD1094	Screw cap	\$6.00
JOR53VD10M	Screw cap, M88	\$4.20
JOR53VD26	Screw cap, M91	\$9.00
JOR53VD22	Sinker	\$2.25
JOR53VD6	Spring sleeve	\$2.40
JOR53VD7M	Spring, M86	\$2.40
JOR53VD23	Tubing	\$2.40
JOR53VD1494	Valve and washer	\$24.00



Large Animal Supplies

Drenches

Henke Drench-Matic 23cc

An automatic syringe for administration of solutions and suspensions. Its transparent plastic graduated barrel allows instant check of dosage setting. An "anti-block" valve system prevents blocking, so that smooth continuous operation is guaranteed. Easily adjusts from 0-23ml in 2.5ml increments. Special hardened enamel painting provides both aesthetics and durability.

JOR128M Drench-Matic Syringe complete with container. **\$160.00**

Henke Drench-Matic Parts

JOR128M	Drench-Matic Syringe complete with container.	\$172.00/ea
JOR128MD1	Barrel frame	\$36.00/ea
JOR128MD2P	Plastic barrel, 23cc	\$10.50/ea
JOR128MD3	Front end piece	\$15.00/ea
JOR128MD4	Round washer	\$3.00/ea
JOR128MD5	Lock nut for #3	\$3.00/ea
JOR128MD6	Valve and washer	\$6.90/ea
JOR128MD7	Valve spring	\$4.50/ea
JOR128MD8	Nozzle and washer	\$16.50/ea
JOR128MD8W	Nozzle washer only	\$1.80/ea
JOR128MD9	Nozzle nut	\$7.50/ea
JOR128MD10	Piston rod complete (6,7,11,12,13,14)	\$47.00/ea
JOR128MD11	Piston rod	\$28.00/ea
JOR128MD12	Valve screw	\$9.00/ea
JOR128MD13	Piston washer	\$4.50/ea
JOR128MD14	Nylon piston	\$15.00/ea
JOR128MD15	Front handle	\$33.00/ea
JOR128MD16	Spring pin	\$1.20/ea

JOR128MD17	Rear handle	\$40.00/ea
JOR128MD18	Plastic insert (2)	\$1.80/pr
JOR128MD19	Handle screw	\$6.00/ea
JOR128MD20	Dosing screw	\$7.80/ea
JOR128MD21	Dosing screw nut	\$7.50/ea
JOR128MD22	Handle spring	\$6.00/ea
JOR128MD23	Lower spring screw	\$7.80/ea
JOR128MD24	Disc	\$1.80/ea
JOR128MD25	Knurled knob	\$12.00/ea
JOR128MD26	Frame screw	\$2.40/ea
JOR128MD28	Feeding tube	\$10.50/ea
JOR128MD30	Injection attachment	\$15.00/ea
JOR128MD30W	Washer for #30	\$2.10/ea
JOR128MD31	Container complete	\$37.00/ea
JOR128MD32	Cap & nozzle	\$3.90/ea
JOR128MD33	Straps	\$10.50/ea

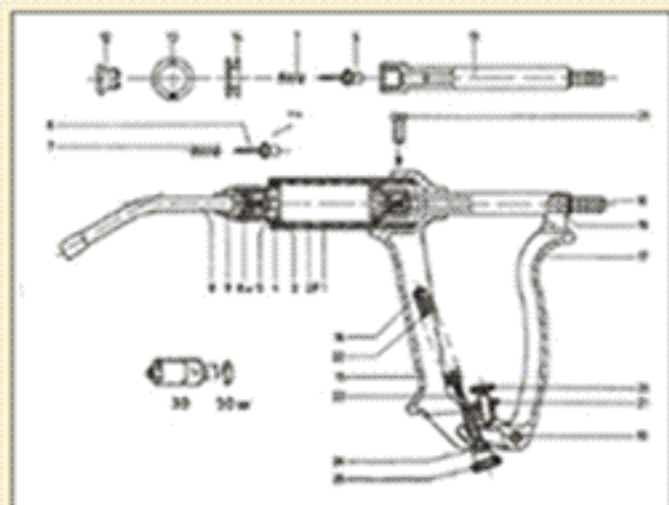

Vaxi-Drench 15 Injector/Drenche, 15cc

Designed for administration of all drenches or injectable solutions within its dose range. Comes complete with 2.9 liter vinyl reservoir, strapping, funnel and necessary tubing. Adjust from 2.5cc to 15cc in 1/2cc increments.

JOR126 Injector/Drencher **\$274.00/ea**

Vetamatic Syringe Parts

JOR126D19	Adaptor	\$15.00
JOR126D31	Cap & nozzle	\$28.00
JOR126D29	Container complete	\$54.00
JOR126D18	Cylinder	\$24.00
JOR126D15	Cylinder cage	\$48.00
JOR126D17	Cylinder seal ring	\$3.90
JOR126D13	Lock nut	\$7.50
JOR126D23	Dosage adjuster screw & nut	\$7.50
JOR126D30	Feed tube & clamps	\$9.00
JOR126D22	Handle	\$30.00
JOR126D29	Container complete	\$54.00
JOR126D10	Injection attachment	\$24.00
JOR126D20	Lever	\$48.00
JOR126D21	Lever pad, set of 2	\$7.00
JOR126D27	Lever screw	\$12.00
JOR126D11	Needle nut	\$9.00

JOR126D12	Nozzle	\$15.00
JOR126D16	Nozzle nut	\$9.00
JOR126D9	Nozzle seal ring	\$2.70
JOR126D1	Piston cap	\$7.80
JOR126D5	Piston spacer	\$7.50
JOR126D4	Piston washer (2)	\$6.75
JOR126D6	Push rod	\$38.00
JOR126D32	Repair kit, parts 2,3,4,7,8,9,17	\$22.50
JOR126D24	Return spring	\$6.00
JOR126D25	Return spring adjuster	\$12.00
JOR126D26	Return spring adjuster screw	\$9.00
JOR126D3	Valve & seal ring	\$8.70
JOR126D7	Valve & seal ring	\$8.70
JOR126D2	Valve spring	\$2.10
JOR126D8	Valve spring	\$2.10
JOR126D28	Handle clamp screw	\$2.70

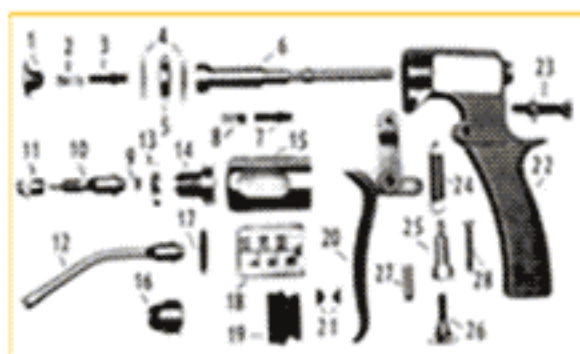

Large Animal Supplies

Emasculators

Serra Emasculator

This instrument draws the cord concentrically into the jaws, thus preventing slipping of the cord. Hemorrhage is reduced to a minimum. Ratchet holds emasculator lock, as in JOR37.

JOR37S Hauptner, 14", Chrome \$675.00/ea
 JOR37SS Stainless Steel \$515.00/ea

BUY NOW

White's Modified Emasculator

White's Modified Emasculator with extra crushing area.

JOR36W Stainless steel, 12" \$202.00/ea
 JOR36WS Stainless steel, 8" \$66.00/ea

BUY NOW

Standard Emasculator

Hausman Standard Emasculator.

JOR36P Stainless steel, 12" \$116.00/ea

BUY NOW

Small Emasculator

Small Emasculator. Stainless steel 7 1/2".

JOR36S 7 1/2" \$81.00/ea

BUY NOW

Serra Modified Emasculator

Hauptner's finest emasculator, excellent for equine work. For one-hand use. A concave cutting plate draws the cord concentrically into the jaws of the castrator, whereby slipping of the cord is avoided. The cord and surrounding strands are centrally gripped, pressed together and cut through. Reduces tissue slippage and post-op hemorrhage.

JOR37SA Hauptner, 14", Chrome \$770.00/ea
 JOR37SAS Stainless Steel, 14" \$555.00/ea

BUY NOW

Hauptner Reimer Emasculator

JOR37H Chrome \$890.00/ea



BUY NOW

Jorvet Emasculator Instrument Aid

JOR37CA \$160.00/ea

BUY NOW

Equivet Cervical Forcep

To grasp equine cervix during embryo transfer. 54 cm L 30mm jaw. (not pictured)

JOR15CE 54 cm L 30mm jaw. \$325.00/ea

BUY NOW

Emasculatome

With cord stop for bloodless castration. Includes wrench on all models.

JOR37EMC 14" \$146.00/ea
 JOR37EMB 12" \$140.00/ea
 JOR37EMD 16" \$152.00/ea
 JOR37EME 19" \$162.00/ea
 JOR37EMA 9" \$117.50/ea

BUY NOW

NEW

Newberry Castrating Knife

Stainless Steel. Will split the scrotum for easier removal of testicles.

JOR37N 10 1/2"L. \$31.50/ea

BUY NOW



Newberry Blade

JOR37NB \$4.20/ea

BUY NOW

Knee Brace for Emasculatome

JOR37K Emasculatome Knee Brace for large models. \$15.00/ea

BUY NOW

Elastrator (replaces JOR36)

Heavy-Duty Elastrator for applying latex bands used in tail docks and castration. Metal

JOR36HD 22cm (8 1/4") L. \$19.50/ea

BUY NOW

Latex Elastrator Bands

High-quality latex bands.

JOR36B 100 pack \$2.10/bg

BUY NOW

Jorvet Even Crush Emasculator

Extra crushing area moves as crushing takes place.

JOR36E Stainless steel, 12" \$202.00/ea



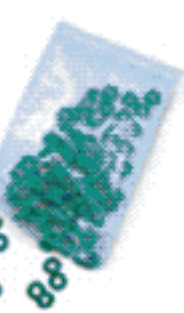

Large Animal Supplies

Sinus Trephine & Wolftooth Dental

Pig Tooth Nipper

JOR42H	Nickel-plated. 5 1/2"L	\$18.00/ea
JOR42HS	Stainless steel. 5 1/2"L	\$9.90/ea



BUY NOW

Equine Sinus Trephine

JOR161E	2"	\$145.00/ea
---------	----	-------------

BUY NOW

Horsley's Trephine

JOR161A	Complete, 1/2"	\$52.00/ea
JOR161B	Complete, 3/4"	\$52.00/ea
JOR161C	Complete, 1"	\$52.00/ea

Trephine Head Only

Not Pictured		
JOR706THL	25mm	\$120.00/ea
JOR706THM	22mm	\$120.00/ea
JOR706THS	19mm	\$145.00/ea

Trephine Handle Only

JOR706THH	\$76.00/ea
-----------	------------

Trephine Set

Not Pictured		
JOR706TS	(handle and 3 heads)	\$430.00/ea

Percussion Chisel

Dental Chisel with sliding bar or percussion handle. The working end has a notched "V". It works great for removing upper premolar hooks and lower rear molar hooks. Stainless steel.

JOR701	23" L, collapsed	\$168.00/ea
--------	------------------	-------------

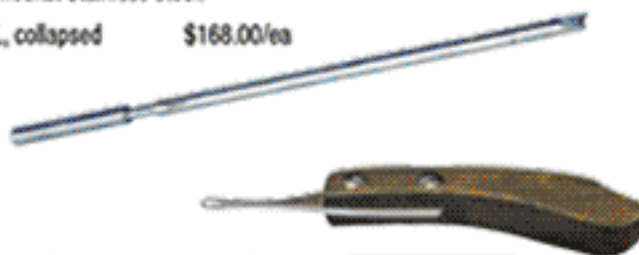

BUY NOW

Small Loop Abscess Knife

Designed to curette out the smallest of abscess with this very sharp, but small loop. Left handed only, ergonomic shaped wood handle.

JOR34L		\$46.50/ea
--------	--	------------

Short/Narrow Jaw Molar Extractor Forceps

Serrated short jaw creates good purchase on cheek and premolar retained deciduous teeth. These forceps have a shorter or smaller jaw surface than compared to the standard JOR43 Molar Forceps for wide jaw surface.

JOR43B	21" length	\$180.00/ea
--------	------------	-------------



BUY NOW

Wolftooth Extractor Set

JorVet

Includes four different sized interchangeable heads that fit completely around the tooth reducing chance of slipping and injuring the soft tissue or gingiva. Includes elevator blade for loosening tooth. Also can be used to remove tooth fragments.

JOR711	Comes in convenient canvas case.	\$302.00/ea
--------	----------------------------------	-------------

BUY NOW

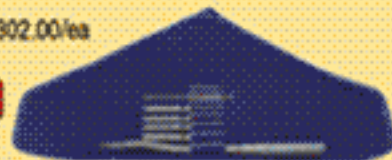

Wolftooth Extractor Forcep

Wolftooth Extractor Forceps. Stainless steel.

JOR43H	11 1/2"L	\$45.00/ea
--------	----------	------------

JorVet



BUY NOW

Wolftooth Elevator

JorVet

The length of the blade can be shortened or lengthened as desired by loosening the set screw with the wrench.

JOR43W	\$23.25/ea
--------	------------

BUY NOW



Wolftooth Elevator Set

BUY NOW

This attractive professional looking kit has six different instruments to help elevate any size of wolf tooth.

- Different elevators:
- 5mm sharp concave point with rounded backside, 6" length
- 5mm sharp concave point with a curved head, 6" length
- Large 9mm concave sharp head, 6" length
- Longer, heavier handle with a 5mm slightly curved deep concave head, 9" length
- Longer, heavier handle 5mm deep concave head, 9" length
- 9mm concave curved replaceable head on ergonomic curved heavy handle, 8" length

All in handy, padded black zipper pouch with red velvet lining

JOR43Y	\$99.00/ea
--------	------------



Wolftooth Elevator Set

Two different head sizes allow this instrument to "cap" the wolf tooth. By rotating clockwise and counter clockwise, the tooth can be separated from the alveolus. Angulated head is useful on teeth that are set well back.

JOR43AB	\$110.00/ea
---------	-------------

BUY NOW



Drinkwater Mouth Gag

Drinkwater Mouth Gag for cattle. Hold-onto inter-dental space. Self-retaining.

JOR38D	(right or left)	\$21.00/ea
--------	-----------------	------------

BUY NOW



Large Animal Supplies

Mouth Gags, Speculum & Dental Halters



Equivet Dental Halter

Especially useful for prolonged procedures. This special halter has a large, sturdy nose band made of a leather-covered round metal circle.

JOR914 A small ring is at each 90° for attachment of a support or restraint rope. \$248.00/ea

BUY NOW



Twitch **BUY NOW**

Kendall model. Complete with tie rope.

JOR44 Stainless steel, 13". \$15.75/ea

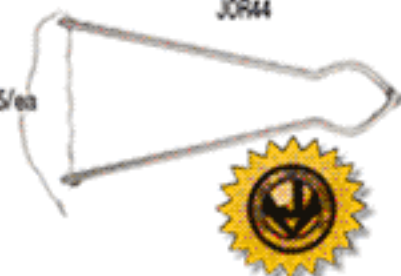

JOR44



Meister Equine Mouth Gag & Light

"The ultimate speculum for doing the right job." Originally developed, designed, and patented by Dr. Jack Meister. This speculum is the gold standard for doing proper and thorough equine dentistry. A full-mouth speculum. Stainless steel. Includes Biothane straps. Improvements include ridge along ratchet to help avoid side slippage. Recessed areas in upper dental plate for placement of light source (JOR38X) included. Caution should be used with all full-mouth equine speculums. Be sure set-screw is set properly to prevent slippage.

JOR382M Modified \$1,490.00/ea



BUY NOW



McPherson Mouth Gag

Full-mouth gag for equine dental work. Comes complete with leather straps and tooth plates for upper and lower incisors.

JOR38MPS Stainless Steel \$356.00/ea

Pony Size Mouth Speculum
JOR38MPSP Pony Size, Stainless Steel. \$350.00/ea



BUY NOW

Schoupe Wedge **BUY NOW**

Reduces the danger of slipping with this instrument since it is held in place by the equine cheek area. Inserted without difficulty. It permits greater freedom in treating any part of the oral cavity.

JOR38S Tie rope included. \$52.50/ea



Meier Dental Wedge

Helps facilitate examination of the mouth and floating of teeth.

JOR38M \$51.00/ea

BUY NOW



Bayer Mouth Wedge

This oral speculum is very handy when examining the oral cavity or doing dental work in equine.

JOR38 Stainless Steel \$104.00/ea



BUY NOW

JorVet

Equivet Mouth Wedge **BUY NOW**

JOR38K Stainless steel. \$89.50/ea

Replacement Rubber Block

This design employs molded rubber blocks. These give an atraumatic cushion plus more comfort for the horse. The rubber block is simply replaced when worn.

JOR38KB \$25.50/ea **BUY NOW**

JorVet



Equivet Pony Size Mouth Wedge

This design employs molded rubber blocks. These give an atraumatic cushion plus more comfort for the horse. The rubber block is simply replaced when worn.

JOR38KP Stainless steel \$88.00/ea

BUY NOW

Spare Rubber Block

This design employs molded rubber blocks. These give an atraumatic cushion plus more comfort for the horse. The rubber block is simply replaced when worn.

JOR38KPB for Pony mouth wedge \$21.00/ea



BUY NOW

EquiVet Cheek Retractor

Pulls the cheek gently away from the cheek teeth so occlusion can be evaluated on a closed mouth. Also useful for providing more room when power float equipment is being used. By turning retractor around, you get two sizes.

JOR938 Stainless Steel \$55.00/ea

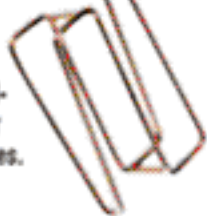

SIGN UP FOR WEEKLY EMAIL SPECIALS @ WWW.SHOPMEDVET.COM

13822 WEST BOULTON BLVD. METTAWA, IL 60045

Phone 800-544-7521

360

WWW.SHOPMEDVET.COM

Fax 800-204-2177



Jorvet Equine Hoof Positioning Blocks

These simple blocks elevate the hoof off the ground for better x-rays of the lower limb including evaluation of any P3 rotation.

- Lightweight, shatterproof, polycarbonate and wood construction
- Non-slip surface covered with special 3M material Radiopaque. Cross hairs provide geometric position indicator on the exposed film.
- Dual cassette holding slots for lateral and AP views
- Holds all sizes of x-ray cassettes
- Grid ready — has room in cassette slot to hold a grid if deemed necessary
- Attractive storage bag 12"L x 8"W x 10"H

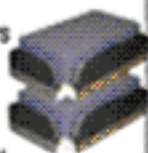

JOR492X Block size is: 11"L x 7 1/4"W x 3 1/2"H \$186.00/pr

BUY NOW



Eyesaver™ Eye Patch

Jorvet EyeSaver™, the ultimate in eye care, features the exclusive Equine Eye Patch. EyeSaver's Eye Patch effectively closes the horse's eye for maximum pain relief while allowing for constant monitoring of the injury or problem. EyeSaver affords the eye the most complete rest possible, eliminating the need for surgical closure. Don't let minor injuries become major problems—order your EyeSavers now. You'll be glad you did.

EyeSaver Kit contains:

- EyeSaver hood
- 3 tear pads
- 3 snap-on rings
- 25 gauze pads

Jorvet

BUY NOW

JOR477L	Standard, Left	\$84.00/ea
JOR477R	Standard, Right	\$84.00/ea
JOR478L	Left, X-Large	\$84.00/ea
JOR478R	Right, X-Large	\$84.00/ea
JOR479L	Foal/Weanling, Left	\$84.00/ea
JOR479R	Foal/Weanling, Right	\$84.00/ea
JOR478XL	XX-Large, Left	\$86.00/ea
JOR478XR	Right, XX-Large	\$86.00/ea
JOR479DS	Double Sided, Foal/Weanling	\$112.00/ea
JOR477DS	Double-Sided, Standard	\$112.00/ea
JOR478DS	Double-Sided, X large	\$112.00/ea
JOR478X LDS	Double Sided, XX- Large	\$124.00/ea

Replacement Eyesaver™ Eye Patch

JOR479D	Tear Duct Pad Set Replacement	\$38.00/ea
JOR479DF	Ring Set for Foal Size Eyesaver	\$38.00/ea

Equine "Army Surplus" Brown Leg Wrap.

This popular wrap was originally an army surplus product. The thick pad is brown on one side, white on the other. It is combined with two rolls of 6" brown cling gauze for a complete wrap. 18" x 22" brown gauze pad.

JOR8490 18x22 pad w/ 6" brown gauze (2) \$7.20/ea

BUY NOW

NEW

Jorvet Equine Haler **BUY NOW**

A reusable inhalation "spacer." The one-way valve allows the medication to be passed only when the horse inhales. It can be easily cleaned for continued use. The inhalation device has been developed specifically for accurate administration of pharmaceuticals to horses with inflammatory respiratory diseases including chronic obstructive pulmonary disease (i.e., recurrent airway obstruction, or RAO). The Equine Haler provides a convenient method of administering all available types of metered dose inhalers (MDI) to horses. The MDI delivers the medicine at a suitable particle size, (<5 microns) for direct distribution to the small airways. Developed in Denmark and tested at the Centre for Equine Studies, Animal Health Trust, Newmarket, UK.



JOR844 One treatment takes 1-2 minutes. \$184.00/ea

Nequizer Equine Nebulizer Kit **Jorvet**

- Portable breath regulated nebulizer. Effective nebulization is all about:
- High lung deposition
- Ease of use
- Patient acceptance
- Minimizing wastage Based on the ultrasonic technique the Nequizer is:
- Portable - handheld, rechargeable
- Intelligent - only operates when horse breathes
- Rapid - delivers 5 ml of medication in 15-20 breaths or 4- 5 minutes
- Direct - no tubing or large mask for aerosol to be deposited on • Acceptable - low-resistance, quiet operation will not alarm horses
- Optimized - small median particle size (2.8um) with 90% of particles <5.5um
- Versatile - can be used with any water based solution
- User-friendly - light weight, ergonomic handle
- Visible - clear plastic chamber with indicator to confirm correct operation



JOR844N Battery Powered \$995.00/ea

Medication Cups **Jorvet**

JOR844NC 5cc, 50pk \$39.00/pk

Jorvet Equine Incisor Gag **BUY NOW**

There are situations where it is only necessary to examine the incisors. This simple gag is placed in the mouth the same way as a bit in the interdental space. It creates easy access to the incisors. Heavy-duty, but comfortable rubber held in place by adjustable nylon rope.

JOR38G Heavy-duty \$34.90/ea



Equine Leg Wrap & Technovit Treatment

Jorvet Equine Leg Wrap

Made of soft, quality bulk cotton which is covered on both sides with a permeable thin layer of nonwoven material. The wrap acts much like a diaper in that the wound exudate is lifted and absorbed into the thick middle cotton layer. A dark mark mid-line runs full length to give proper orientation during application. A wide variety of materials and sizes are now available:

JOR849	Large Bulk Roll, 12" x 10 yds.	\$21.60/ea
JOR849A	Large Bulk Roll, 14" x 10 yds.	\$24.50/ea
JOR849B	Large Bulk Roll, 16" x 10 yds.	\$28.00/ea
JOR849AN	Individual, Non-sterile, 12" x 36"	\$4.50/ea
JOR849BN	Individual, Non-sterile, 12" x 42"	\$4.65/ea
JOR849CN	Individual, Non-sterile, 14" x 42"	\$4.80/ea
JOR849DN	Individual, Non-sterile, 16" x 54"	\$6.75/ea
JOR849AS	Individual, Non-sterile, 12" x 36"	\$5.25/ea
JOR849BS	Individual, Non-sterile, 12" x 42"	\$5.40/ea
JOR849CS	Individual, Non-sterile, 14" x 42"	\$5.55/ea
JOR849DS	Individual, Non-sterile, 16" x 54"	\$7.05/ea



Jorvet

BUY NOW

Equine Nylon Rope Twitch

Twitch with heavy duty nylon rope. 5" dia. loop with 25" flat handle.

JOR44B	25" Flat Handle	\$34.50/ea
--------	-----------------	------------



Subpalpebral Ocular Lavage Kit

A silicone catheter that is surgically placed with a tunneling trocar into the subpalpebral. The special base enlays flat against the mucosa, allows ease of administration of medication for extended periods in serious ophthalmic condition. Sterile Kit Includes:

1. silicone lavage catheter
2. trocar
3. blunt tipped (for insertion into catheter)
4. injection cap

JOR150C	8fr	\$56.00/ea
---------	-----	------------



BUY NOW

Jorvet Black Plastic Hoof Block

The use of hoof blocks is very popular in the treatment of hoof problems in cattle. We offer several different types.

JOR61BX	\$2.10/ea
---------	-----------



BUY NOW

Technovit Block (Wood)

The use of hoof blocks is very popular in the treatment of hoof problems in cattle. Jorvet offers several different types.

JOR61B	wooden, 2"	\$1.35/ea
JOR61BH	wooden, 3/4"	\$1.04/ea



BUY NOW

Technovit 12 Treatment Kit

Kit includes Technovit liquid, powder, and your choice of hoof blocks. Also included: mixing cups and wooden stirring sticks.

JOR61T12H	w/ 1" wood blocks	\$100.65/ea
JOR61T12W	w/ 2" wood blocks	\$100.65/ea
JOR61T12	w/ Plastic Blocks	\$97.80/ea
JOR61T12S	w/cow plastic boots	\$96.40/ea



Technovit 6 Treatment Kit

Kit includes Technovit liquid, powder, and your choice of hoof blocks. Also included: mixing cups and wooden stirring sticks.

JOR61T6H	w/ 1" wood blocks	\$58.00/ea
JOR61T6	w/ plastic blocks	\$58.50/ea
JOR61T6W	w/2" wood blocks	\$64.90/ea
JOR61T6S	w/cow plastic boots	\$70.50/ea



BUY NOW

Technovit Powder

BUY NOW

Jorvet

This popular acrylic consists of a powder and liquid that, when mixed together, form a strong binding adhesive material. The liquid and powder are mixed together in a roughly 1:2 ratio. Until it hardens, it can be poured and shaped. After it hardens, it can be sawed, drilled, or filed. It has a number of suggested uses.

- Cattle: a block or boot is adhered to the bottom of the healthy or unaffected claw, for sole abscesses or foot rot.
- Horses: quarter cracks, any hoof defects.
- Small animals: replace the connecting rod and K-E clamps for external fixation devices.

JOR61PB	1000 gm	\$65.80/ea
JOR61PA	500 gm	\$36.50/ea

BUY NOW

Technovit Liquid M08

Jorvet

Introducing new, faster, and easier to use Thickened Technovit Liquid called **RAPID-VIT™**.

- No wait time between mixing and application.
- 20% pre-dissolved powder allows RAPID-VIT™ to be applied to the hoof immediately.
- RAPID-VIT™ can be shaped or formed and will not stick to WET hands.

JOR61LAT	240gm	\$24.00/ea
JOR61LBT	M08, 480gm	\$33.00/ea
JOR61LA	240cc	\$21.40/ea
JOR61LB	480cc	\$34.20/ea

BUY NOW



Technovit Cow Boot

Jorvet

slips on the healthy or unaffected claw. Stays on better than regular blocks. Inner sole is grooved for even more holding power. Blue. Can mix Technovit right in toe of the boot

JOR61SL	Left Claw	\$5.40/ea
JOR61SR	Right Claw	\$5.40/ea

BUY NOW



Rapid-Vit 6 Technovit Kit

An even faster technovit product with 6 boots included. Hazardous material. Requires additional shipping charges outside the continental United States.

JOR61T6RV	w/plastic blocks	\$63.00/ea
-----------	------------------	------------

BUY NOW

Large Animal Supplies

Large Animal Endotracheal Supplies & Hog Ringer

Indwelling Uterine Infusor (sterile)

For continuous medication in the treatment of endometritis and other uterine conditions in bovine and equine. It is self-retaining and can be left in place until treatment is completed.

JOR198 Sterile, 30"L. \$7.20/ea

BUY NOW



Foal Nasotracheal Tube

BUY NOW

A cuffed nasotracheal tube used to deliver anesthesia gases and oxygen via nasal intubation. The tubes have a standard 15mm connector.

JOR694 i.d. 7mm, o.d. 10.0mm 55cm Length \$63.00/ea

JOR694A i.d. 9mm, o.d. 12.3mm 55cm Length \$65.00/ea



BUY NOW

Equine Silicon Endotracheal Tube

Universal fitting allows connection to most large animal anesthesia machines and ventilators.

JorVet

JOR151XA	16mm i.d. 8cm L Balloon 70cm L Total	\$99.00/ea
JOR151XB	18mm i.d. 8cm L Balloon 75cm L Total	\$113.00/ea
JOR151Y	24mm i.d. 12cm L balloon 100cm L total	\$130.00/ea
JOR151Z	30mm i.d. 14cm L balloon 100cm L total	\$204.00/ea

Equine Endotracheal Tube

Universal fitting allows connection to most large animal anesthesia machines and ventilators.

BUY NOW

NEW

JOR151X 20mm i.d. 10cm L balloon 90cm L total \$156.00/ea

Jorvet Tracheal Wash Kit

BUY NOW

Transtracheal wash is a very useful diagnostic tool in the treatment of lower respiratory disease in horses. The JorVet Tracheal Wash kit provides a convenient and easy method to obtain high-quality diagnostic samples. The procedure is simple to perform under light sedation with a small local block over the lower third of the neck. Sterile. 15g cannula and 16g needle

JOR283 Catheter 22"L. \$12.90/ea



Silicone Adhesive

BUY NOW

Silicone adhesive for repair of endotube cuffs.

JOR151AT for repair of endotube cuffs. Must be purchased separately \$18.75/ea

Cuff Repair Kit

BUY NOW

Adhesive glue not included. JOR151 AT

JOR151XARC	16mm	\$11.20/ea
JOR151XCRC	22mm	\$16.00/ea
JOR151YARC	26mm	\$16.00/ea
JOR151YRC	24mm	\$16.50/ea
JOR151ZRC	30mm	\$16.00/ea



Equine Silicon Tracheostomy Tube

Silicone softens at body temperature for patient comfort. Balloon inflates via one-way valve. The universal attachment fits large animal anesthesia machine and ventilator hoses. Has a wide outer flexible plate for secure attachment (i.e., umbilical tape)

JOR692B	15.0mm i.d.	\$59.75/ea
JOR692A	12.0mm i.d. has 15mm connector/no balloon	\$55.90/ea
JOR692	20.0mm i.d.	\$74.00/ea
JOR692D	25.0mm i.d.	\$62.00/ea

BUY NOW



Hog Holder with Lock

JorVet Hog Holder with lock for quick release. Designed for easy catching and holding of hogs.

JOR361 New cable design with stainless steel handle. \$39.00/ea

BUY NOW



Caesarian Forceps

With removable soft rubber jaws for grasping the uterus.

JOR15 Stainless Steel, 12"L. \$42.00/ea

BUY NOW



Teat Supplies

Jorvet Teat Bandage

Teat injuries are serious problems and until now have been nearly impossible to properly bandage. The Jorvet bandage is a cohesive polyester bandage that makes it easy to provide a protective bandage over an injured teat.

JOR14TB 2 1/2" W x 15'L, 5 yds. \$12.60/ea

BUY NOW



Teat Tumor Extractor

With two cutting edges that come together for removal of fibrous tissue.

JOR11B 4.5mm dia. \$44.00/ea

BUY NOW



Jorvet Teat Cannula

BUY NOW

Cannula used for infusing medication into teats. Luer adaptor. Nickel-plated brass. 12/pkg.

JOR277BS 2 1/2" with two openings. Stainless Steel. (peritoneal taps) \$27.00/dz



Jorvet Udder Infusion Cannula

Cannula used for infusing medication into teats. Luer adaptor. Nickel-plated brass. 12/pkg.

Jorvet

JOR277A 1 1/2" with one opening. \$24.00/dz

JOR277B 2 1/2" with two openings. \$24.00/dz



BUY NOW

Teat Cannula

BUY NOW

Fits any syringe. In handy tear-off strips. 1 1/3"L. 100/pkg.

JOR12 100 pack \$4.50/pkg



Irrigating Cannula

These plastic cannula are used for irrigation of the lacrimal ducts, wounds, glands, etc. Rounded ends. Flexible tip. Sterile. 5/pkg.

Jorvet

JOR150B Medium, 5 pack \$40.50/pkg



BUY NOW

Short Nozzle Teat Cannula

4mm shaft length. This is a shorter teat cannula for customers preferring not to pass through the streak canal into the teat cistern like conventional cannulae do. 100pk in tear off strips. Sterile.

JOR12X 100/pkg \$11.10/pkg

BUY NOW

Teat Blades

Teat Blades. These blades are designed with a specially shaped cutting edge inside the hook, making a cut in the sphincter in a manner that the outside opening of the teat canal remains whole. Stainless steel.

JOR10 Stainless Steel, 6 pack \$15.00/pk

BUY NOW



Jorvet Teat Curette

BUY NOW

JOR9 7"L., Swedish \$45.00/ea

JOR9C 6"L., Cornell \$15.60/ea



Jorvet Teat Knife

JOR55 \$16.50/ea

BUY NOW

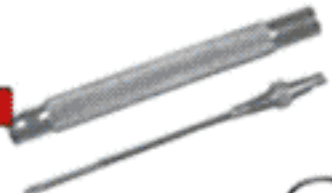

Jorvet Teat Scissors

Christensen Teat Scissors, with cutting edges on the outside of the blade; adjustable opening.

JOR7 6" Length \$48.00/ea

BUY NOW



Jorvet Plastic Expandable Teat Dilator

- Soft comfortable fit
- Individually packed in handy cellophane tear-off strips
- Familiar diamond shape

JOR12D 100/pkg \$16.20/pkg

BUY NOW



Jorvet Teat Tube Display

For cows with injured teats. Each self-retaining tube is packaged individually in a small vial. When tube has been inserted, it fits nearly flush with end of teat. No irritating thornlike protrusions (as found in other teat tubes on the market) are necessary to keep tube in place. 36/card.

JOR13 36 pack \$18.50/pkg

BUY NOW



Dr. Larsen's™ Teat Tube

This is the original Dr. Larson plastic teat tube. Also useful in treating small animal ear hematomas. Sterile. Individually packaged on a display card of 36 tubes.

JOR14L 36 pk. \$84.00/pkg

BUY NOW



BUY NOW

Dr. Irvin's Shurflow Teat Tube Zip Pack

JOR13Z 10 pack \$6.30/pkg



Large Animal Supplies

NIT Teat Tools / Tentome & Lavage Admin Kits

Teat Injury Treatment. Covered or closed teat injury can be caused by being frozen, stepped upon or other trauma. A new system of conservative and natural treatment of closed teat injuries has been developed in cooperation with a European Veterinary School.

The initial treatment consists of drainage of milk and antibiotic infusion with sterile flexible plastic udder infusion cannula.

NIT (Natural Insert for Teats) Teat Dilator. This short dilator consists of a natural waxy material similar to the teat's natural sebum. The teat is bandaged with teat bandage (JOR146).

This NIT dissolves after several days. Later in the treatment regime a sterile soft flexible silicon implant is used to maintain teat canal patency.

NIT - Natural Teat Insert

JOR903 Foil packaged, 20pk \$27.00/pk



BUY NOW

NEW

SIMPL - Silicone Teat Insert

JOR904 20pk \$29.40/pk

Plastic Sterile Teat Infusion Cannula

JOR905 Disposable, Sterile, 10pk \$27.00/pk



BUY NOW

Lichty Teat Knife

JOR9LB Stainless steel, 5 1/2" L, blunt

\$15.90/ea

BUY NOW

Tenotome

BUY NOW

JOR88A	Small, Blunt and Curved, 15 x 3mm blade.	\$9.90/ea
JOR88BC	Blunt and curved, 5cm x 1/2cm blade.	\$24.00/ea
JOR88BS	Blunt and Straight, 5cm x 1/2cm blade.	\$24.00/ea
JOR88SC	Sharp and Curved, 5cm x 1/2cm blade.	\$24.00/ea

Tendon Splitter

Double edged blade. Stainless steel.

JOR89 4cm L blade. \$18.00/ea

BUY NOW

X-Long Teat Tube

Brass stylett is left in tube only during insertion for stiffness. Plastic, flexible, and self-retaining. Sterile. Unit separately packaged in cellophane bag.

JOR13L 3" L, 12/pk \$16.50/dz

BUY NOW

Viscera Retainer

BUY NOW

Effectively retains viscera and omentum during surgical closure of peritoneal cavity. It provides added anchorage and retentive power, yet folds into a narrow roll for easy removal when the incision is almost closed. Silicone; autoclavable.

JOR208B Equine, 9" x 14" \$97.00/ea

Vienna Double OB Hook

BUY NOW

Stainless Steel. Hinged for easier placement.

JOR19W 5 1/2" L \$39.00/ea

Equine Uterine Lavage Administration Kits

These large bore tubing kits are designed to connect large Foley catheters for large volume infusion and collection. The "Y" junction allows for fluid infusion and outflow for drainage or collection. Sterile.

Long tubing with "Y" junction. Extra long tubing 60" (5 ft) both inflow and outflow gives room for fluid administration and collection away from the animal. Attached large bore spikes for inflow at proximal end. The distal end has a barbed fitting for connection to Foley catheter.

JOR1052 60" (5 ft) \$11.70/ea

These large bore tubing kits are designed to connect large Foley catheters for large volume infusion and collection. The "Y" junction allows for fluid infusion and outflow for drainage or collection. Sterile.

Short 6" inflow with female spin

luer lock adapters. This allows hookup to syringe or another administration set. There is a 30" outflow tube. Distal end has a barbed fitting for connection to Foley flushing catheter (JOR282).

JOR1052A \$8.10/ea

These large bore tubing kits are designed to connect large Foley catheters for large volume infusion and collection. The "Y" junction allows for fluid infusion and outflow for drainage or collection. Sterile.

Single line with 60" large bore tubing with proximal spike and distal barbed fitting for attachment to Foley or large bore pipette (JOR286).

JOR1052B \$7.50/ea

BUY NOW

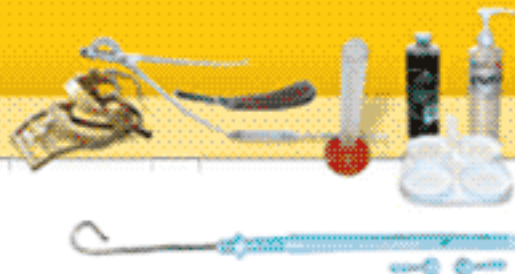

BUY NOW

JOR1052

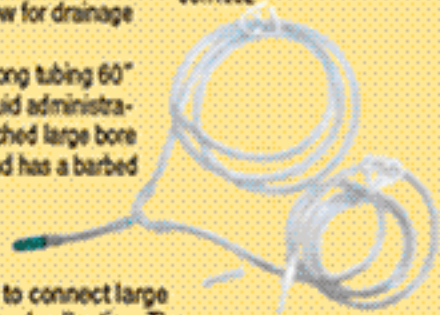

JOR1052A

BUY NOW

JOR1052B



Large Animal Supplies

Hoof Tools

Hoof Knife

BUY NOW



- JOR32HLE Left, Economy, Ebony \$9.75/ea
 JOR32HRE Right, Economy, Ebony \$9.75/ea

JorVet

Left Curve Hoof Knife

JorVet

BUY NOW

- JOR32HWL Wood Handle, Left, Curved, Blade 5/8" W x 2 3/4" L. \$30.90/ea

Right Curve Hoof Knife

JorVet

BUY NOW

- JOR32HWR Wood Handle, Right, Curved, Blade 5/8" W x 2 3/4" L. \$30.90/ea

BUY NOW



Hoof Knife

Hoof Knife with small curl, double edge. Blade 5/8" W x 2 3/4" L.

- JOR34L Left handed only, ergonomic shaped wood handle. \$46.50/ea
 JOR34CLE 5/8" W x 2 1/2" L, Left, Economy \$9.90/ea
 JOR34CRE 5/8" W x 2 1/2" L, Right, Economy \$9.90/ea
 JOR34CNLE 3/8", Left, Economy \$9.00/ea
 JOR34CNRE 3/8", Right, Economy \$9.00/ea

Hoof Knife Hone

JorVet

BUY NOW

Especially developed for hoof knives and will sharpen inside of curl.

- JOR33H \$13.50/ea

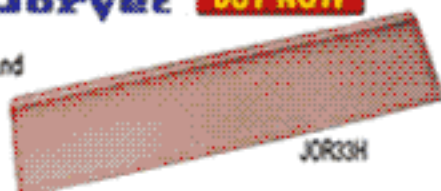

JOR33H

Jorvet Hoof Buffer

- JOR61H \$37.00/ea

BUY NOW



JOR61H

Hughes Hoof Groover

JorVet

BUY NOW

Hughes's Angled Hoof Groover. This hoof groover has an elliptical doughnut-shaped working end. Elliptical opening is 2cm x 1cm. The bottom portion is sharpened. It is great for digging out or curetting hoof abscesses. Stainless steel handles.

- JOR32HG 6 1/4" (16cm) L. Curved \$18.00/ea
 JOR32HGS Straight \$19.50/ea



Hoof Tester

JorVet

BUY NOW

- JOR35P Special Size, Stainless steel. 13". \$36.00/ea

Adjustable Hoof Tester

This sturdy model hoof tester has jaws of stainless steel.

- JOR35F Seven adjustments for every size hoof. \$145.00/ea

Hoof Tester

JorVet

JorVet Standard Hoof Tester.

- JOR35LP Large, Stainless steel. 13". \$42.00/ea
 JOR35B 14 1/2". \$110.00/ea

Hoof Tester

Extra large hoof tester. 21". Max jaw opening is 20cm (8") which is much larger than standard tester. Jaw teeth are large cleats for better hold.

- JOR35XL Stainless Steel, 21" \$80.00/ea

Ryding Hoof Tester

BUY NOW

New design allows for adjustable jaws over entire hoof surface. The jaws remain parallel for more even and steadier diagnostic pressure. The handle accommodates one-handed use, leaving the other hand free to hold the leg or for positioning the hoof. Stainless steel.

- JOR35EC Stainless steel. \$185.00/ea

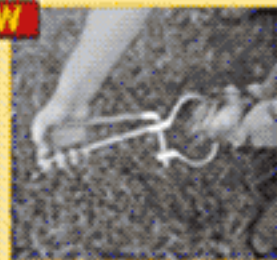

Hoof Trimmer

JorVet

Popular compound action steel model, with extra sharp blades that are replaceable. Green with black handle grips.

- JOR35 Steel, 20" \$125.00/ea

Foot-Rot Hoof Shears

Heavy handles as illustrated, with strong spring and safety clip. Specially designed tempered steel serrated blades.

- JOR131M Stainless steel. \$18.00/ea

Hoof Knife Set

BUY NOW

- JOR32HSE Economy \$60.00/ea

Folding Hoof Knife

Folding Hoof Knife combined with hoof pick. Handy pocket size.

- JOR32F Handy Pocket Size \$12.75/ea

BUY NOW



Large Animal Supplies

Tatto Supplies & Suture Kits

Free Martin Probe

BUY NOW

The JorVet Freemartin Probe is a newly developed vaginal probe to detect freemartin heifers and/or determine if heifers born co-twin to a bull have a normal reproductive tract. The crucial probe end length is 7cm. Research has shown that no freemartin calf has a vaginal length longer than 7cm. The distal end of the narrower center section is 14cm from the tip. Over 95 percent of heifers born co-twin to a bull and with a normal reproduction tract have a vaginal length of 14cm or more. Animals with a vaginal length of 7-14cm should have chromosome testing done to confirm if a freemartin. This probe is designed to be used on heifers 30 days of age or less.

JOR99FM \$27.00/ea

JorVet

Small Animal Electric Tattoo Kit

Complete tattoo kit in an attractive foam-padded case. This state-of-the-art animal marker features fingertip control for precise and accurate tattooing on the smallest of animals.

JOR276 Kit includes: \$546.00/ea

- Foam padded case
- Finger tip control
- Three needle bars
- Black tattoo ink
- 110V AC current

Power Supply

JOR276D4 For Jor276 \$140.00/ea

Tattoo Pliers

BUY NOW

Used for positive permanent livestock identification. Heavy-duty construction. Marker jaws holds four easily interchangeable letters or digits. Digits only go in one way. Positive ear release.

JOR642 • Marker jaws holds four easily interchangeable letters or digits. \$24.00/ea

- Digits only go in one way.
- Positive ear release.

JOR642

Small Tattoo Plier

BUY NOW

JOR641S \$18.00/ea

Tatto Digits

JOR641SL A-Z, 5/16" \$24.00/ea

JOR641SN 0-9, 5/16" \$9.00/ea

BUY NOW

Jorvet Tattoo Ink

JorVet

BUY NOW

Widely used for identification in livestock, especially cattle and swine. JorVet tattoo ink is easily read years after tattooing. Now Jorvet has expanded the range of permanent tattoo inks. Inks are available in black and green, and varied packaging.

JOR276PG green paste, 5 oz. \$18.90/ea

JOR276PGS green paste, 1 oz. \$6.60/ea

JOR276RB black, roll-on, 2 oz. \$6.90/ea

JOR276RG green, roll-on, 2 oz. \$7.35/ea

JOR276T black, 2 oz. \$15.00/ea



Lamb Nipple

BUY NOW

Natural feeling rubber with "X" pierced tip fits most soda type bottles. Raised ridge inside helps hold nipple onto bottle. Side tab helps pull off and on.

JOR920 Black, 4/pack \$3.00/ea

JOR920R Red, 4/pack \$3.00/pk

Lambing Snare

Small plastic snare with "Y" configured head. Nylon covered steel cable. Helps in holding the lamb's head until the feet can be reached.

JOR921 \$24.00/ea

Suture Kit

BUY NOW

JOR91KA Equine, Size 0 Braunamid with #2 3/8 reverse cut suture needle \$4.80/ea

JOR91KB Bovine, #3 Braunamid suture with XL 3/8 reverse cut needle \$5.40/ea

Suture Kit Calves & Pigs

BUY NOW

JOR91KD Calves and Pigs, Braunamid 60" long with size 2 needle, 3/8 reverse cut \$5.40/ea

DA Toggle Suture

used in the Grymer/Sterner method for nonsurgical percutaneous fixation of the left displaced abomasum (LDA).

JOR191 Pair \$9.30/pr

LDA Toggles Suture Button

This suture button has a number of different applications in bovine surgery the most common being LDA's. It is a flat pliable oval shaped disc with four round contoured holes. It helps reduce suture tension by distributing the pressure over a wider surface area. Suggested uses:

- LDA toggle button repair
- Uterine/vaginal prolapse repair
- Umbilical hernia in calves
- Measures 4" Long x 1 5/8" Wide x 1/16" Thick
- 6 buttons/pack
- Neon green color for easy observation
- Complete directions included

JOR191B 6pk. \$8.25/pk

Trocar/Cannula

Used in the Grymer/Sterner method for nonsurgical percutaneous fixation of the left displaced abomasum (LDA).

JOR191TM Modified \$33.00/ea

See our Suture & Skin Closure Section for a full line of Suture Products

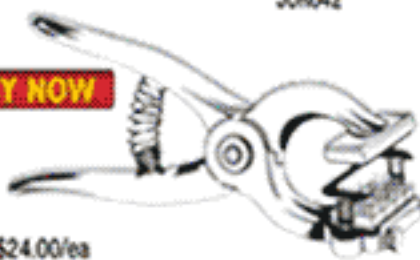



Parson's Full Walking Cast

Spans from the upper cannon bone to the bottom edge of the hoof. It will immobilize both the fetlock and pastern joints. A rigid section of special unbreakable plastic is sewn and enclosed in a neoprene protective sheath. The brace is placed down the cranial part of the lower leg. It is attached by stretchable neoprene straps with velcro. The brace can be safely put on or taken off in seconds even by the horse owner. It can be washed and reused repeatedly. The price is half of the cumbersome ski boot style brace plus is lightweight and well-tolerated by the equine patient. 7" w x 13" h, secured by three attached 4" x 24" neoprene stretchable straps with double velcro closure. Washable neoprene construction. Padded for multiple day use.

JOR637 \$204.00/ea



Attached neoprene wrap

Encased rigid plastic

Covered by separate neoprene wrap



Three different attached neoprene wraps with velcro

Parson's Equine Wrap

This special neoprene stretchy wrap with velcro straps can take the place of expensive bandage materials like Elastikon® or Vetrap™. Especially true when numerous bandage changes are needed over time. It can be washed and reused repeatedly.

JOR637B 4" Wide x 48" long, 2 pack \$33.00/pk

BUY NOW

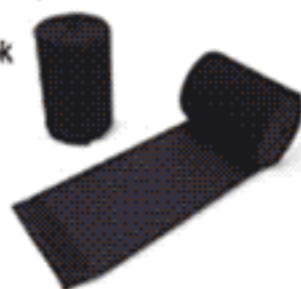

Parsons 4- Strap Leg Stabilization

Designed to place over the carpus down to top of hoof wall for stabilizing and support.

- Reinforced rigid insert for stability
- Washable neoprene construction
- 4 to 5 attached plastic neoprene straps
- Self padded for short term, use cotton under lays as needed for long term
- Can be placed on front or either side of leg

BUY NOW



JOR637CLS Colt Leg Stabilizer 4 strap 5 1/2" w X 18" h \$280.00/ea
 JOR637HLS Horse Leg Stabilizer 5 Straps, 6" x 23" \$350.00/ea

Parsons Bowed Tendon Correction

This rigid concave brace is designed to fit over the flexor tendon for support in case of "Bowed tendon". It is self-padded with reinforced insert for stability. Made from washable neoprene. Can be used alone or in conjunction with Parsons walking cast.

JOR637BT 2" w x 7" long. \$42.00/ea

BUY NOW

JorVet Prolapse Kit **JorVet**

A kit for the correction of preparturient vaginal prolapse. This kit consists of 2 large buttons connected with a plastic rod that retains the vagina in place. Calving can take place with no interference. Detailed instructions included.

BUY NOW

JOR359 \$4.80/ea

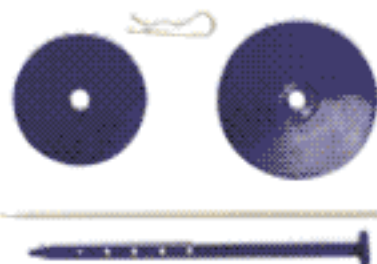

Catheters

Silicon Foley Catheter

Jorvet BUY NOW

Silicone is the preferred material for foley catheters. This catheter softens at body temperature. Equipped with a one-way valve for balloon inflation. Sterile.

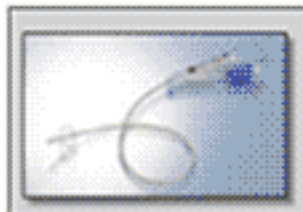

JOR693	5fr o.d. x 30cm L, White Opaque	\$44.80/ea
JOR693A	6fr o.d. x 30cm L. 1.5cc balloon w/stylet, Clear	\$15.60/ea
JOR693B	8fr o.d. x 30cm L. 3cc balloon w/stylet, Clear	\$9.60/ea
JOR693C	10fr o.d. x 30cm L. 3cc balloon w/stylet, Clear	\$9.90/ea
JOR693D	12fr o.d. x 40cm L. 5cc balloon, Clear	\$9.00/ea
JOR693Y	10fr o.d. x 55cm L. 3cc balloon, White opaque	\$39.00/ea
JOR693W	5fr o.d. x 55cm L. 2cc balloon, White Opaque	\$56.00/ea
JOR693X	8fr o.d. x 55cm L. 3cc balloon, White Opaque.	\$44.80/ea

Stallion Catheter

Stallion Urinary Catheter. Used in both geldings and stallions. Flexible plastic with plastic stylet. Sterile. 6.6mm x 137cm L.

JOR90S	137 cm	\$11.70/ea
--------	--------	------------



BUY NOW

Mare catheter, 60 cm

JOR90SM	8.6 x 60cm L.	\$11.10/ea
---------	---------------	------------



BUY NOW

Equine Uterine Lavage "Y" Catheter

"Y" connector, with 12" arms, gives in flow and out flow. Two shut-off clamps. Two different adaptors included.

JOR282YL	Complete "Y" System. 135cm L.	\$66.00/ea
JOR282Y	Complete "Y" System. 95cm L.	\$54.00/ea



BUY NOW

Mare Catheter

MMare Urinary Catheter. Metal with ring.

JOR90M	30cm x 8mm.	\$24.00/ea
--------	-------------	------------



BUY NOW

Extended Use Polyurethane Catheter

Most traditional jugular catheters are teflon. They can create a thrombosis and crack if left in place for over 48 hours. The development of new materials allows large-bore catheters that can safely be left in-dwelling for up to 10 days. The Jorvet Extended Use Catheter softens at body temperature. Many of the common catheter-related problems, such as phlebitis, can be minimized with these catheters.

- 14g and 16g polyurethane catheter over needle
- Non-thrombogenic and non-cracking
- Can be safely left in the vein for up to 10 days
- This same catheter is used in 24 out of 27 U.S. veterinary teaching hospitals
- Suture wings with holes or suture groove attachment

JOR458A	14g x 5 1/4"	\$11.10/ea
JOR458B	16g x 5 1/4"	\$11.10/ea
JOR458C	16g x 3", foal	\$11.40/ea

BUY NOW



Silicone Equine Flushing Catheter

Large silicone catheter with large Foley inflatable balloon.

- Embryo transfer/collection
- Lateral eyes on open ended tip
- Inflatable balloon allows fluid retention in uterus when the catheter is passed beyond the cervix.
- Diameter: 33fr (8mm i.d. x 11mm o.d.)
- Includes two different adaptors

Reducing Connector (JOR282d2) to attach tubing
Barbed Connector (JOR282d1) with standard luer fitting

JOR282	65cm L.	\$48.00/ea
JOR282L	135cm L.	\$57.00/ea

Allows connecting of syringe to catheter

JOR282D1	Allows connecting of syringe to catheter 4mm to 6mm. Not tapered	\$3.30/ea
----------	--	-----------

Double Christmas Tree Connector connects tubing from 4mm to 12mm i.d.

JOR282D2	Connects tubing from 4mm to 12mm i.d. 2/pk 4mm to 6mm. Not tapered	\$3.15/ea
----------	--	-----------

Smaller Barbed Connector with female luer lock. 2.8mm-7mm.

JOR282D4	w/female luer lock 2.8-7mm	\$3.75/ea
----------	----------------------------	-----------

Smaller Christmas Tree Connector. 4mm to 6mm. Not tapered.

JOR282D3	2pk 4mm to 6mm. Not tapered	\$5.70/pk
----------	-----------------------------	-----------

Jorvet Large Animal IV Catheter

Large animals need large volumes of IV fluids in a short period of time. Naturally, the IV catheter needs to be a large bore, and often is even put in bilaterally to maximize fluid administration speed.

Features:

- Large bore: 10g and 14g catheters. The 10g is the largest available.
- Longer lengths: 51/2" catheter lessens the risk of pulling out the catheter.
- Pebax® catheter implant grade material: much less bioactive to lessen thrombosis formation for long term >3 days placement.
- Kink resistant: other catheters like Teflon will kink upon bending, making them unusable.
- Clear catheter material versus opaque Teflon.
- Suture patch: a thin, flexible patch with twin eyelets. Allows suturing in place or hold with tissue adhesives. Reduces catheter pull-out.
- Competitive pricing and available through Jorvet distributors.

JOR457A	14g x 5.5	\$13.80/ea
JOR457B	10g x 5.5	\$12.30/ea

BUY NOW

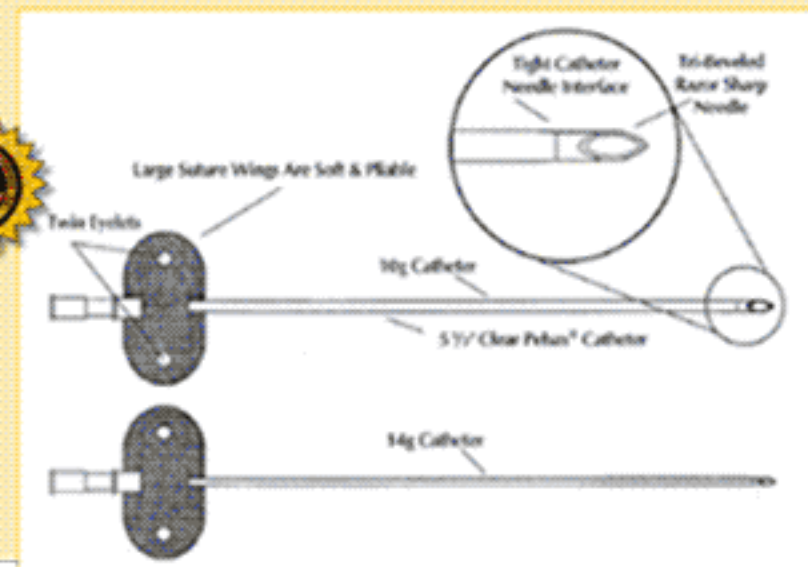

Needles & Fetotomy Supplies

Winged IV Infusion Set



These popular sets are commonly known as Butterfly® style IV sets. They are great for short term IV infusion or in difficult venipunctures. Tubing with female luer fitting is 12" long. A 3/4" razor-sharp needle is attached to flexible colored coded wings.

JOR454A	19g. Yellow, Sterile. 100/box.	\$25.00/box
JOR454B	21g. Green, Sterile. 100/box.	\$25.00/box
JOR454C	23g. Blue, Sterile. 100/box.	\$25.00/box
JOR454D	25g. Orange, Sterile. 100/box.	\$25.00/box



BUY NOW



Jorvet Bleeding Needle



Dozen, Stainless Steel

JOR199A	16g x 3", 12/pkg.	\$30.00/dz
JOR199B	15g x 3", 12/pkg.	\$30.00/dz
JOR199C	14g x 3", 12/pkg.	\$30.00/dz

BUY NOW



Jorvet Needle Bar

JOR276D1	5 pack (with needles)	\$53.00/pkg
----------	-----------------------	-------------

BUY NOW

Spinal Needles

Spinal Needle. General purpose aspiration biopsies and drainage procedures. Matched ground bevel eliminates possibility of tissue coring. Attaches to standard luer fitting. Available with echogenic enhanced tip (ultra-sound). Not autoclavable. Sterile.

JORS29F	Unmarked Needle. 22g x 9cm (35/8").	\$2.40/ea
---------	-------------------------------------	-----------



True Cut Style Biopsy Needle

BUY NOW

Long enough to reach any biopsy site. 1mm x 20mm specimen chamber.

JOR118D	18g x 10cm (4").	\$25.50/ea
---------	------------------	------------

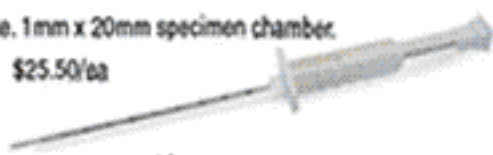

Jorvet Feeding Needle

BUY NOW

Luerlock hub with stainless steel tube and nickel-plated silver ball on the end.

JOR194SDH	14g X 4", Straight	\$46.00/ea
JOR194SDH	14g X 4", Curved	\$46.00/ea



Fetatome Case

This vinyl case is a great organizer with individual pockets for OB handles, wire saw, chains and other OB equipment. Also protects fetatome from scratches and wear.

JOR18C	\$48.00/ea
--------	------------

BUY NOW



Fetotomy Procedure Booklet

JOR18USB	\$20.00/ea
----------	------------

BUY NOW

Thygesen Fetatome with Coil

Two-tube model with adjustable handle for OB chain. This is the breakdown model, complete with insertion coil and cleaning brush.

JOR18T	33"L.	\$352.00/ea
--------	-------	-------------

BUY NOW



Insertion Coil and Brush

JOR18I	for fetatomes	\$39.00/ea
--------	---------------	------------

BUY NOW



Utrecht Fetatome with Coil

Lightweight model Utrecht Fetatome, with hardened metal head. Includes modified grip with notched plate for OB chains. Complete with insertion coil and cleaning brush.

JOR18US	38"L.	\$332.00/ea
---------	-------	-------------

BUY NOW



Jorvet Nano Paste Syringe

BUY NOW

The use of bioscaffold materials is gaining widespread use in veterinary surgery especially for procedures like TTA. The challenge has been getting formulations that are easy or simple to use. Nano Paste is a white paste formulation that comes in a small sterile syringe. It is easily and precisely injected into the surgery site. There is no remixing freeze-dried granules or trying to pack in putty. Nano Paste has a proven ingredient of bioceramic hydroxyapatite. Hydroxyapatite has been used for over 20 years in human orthopedic medicine with numerous research articles pointing to its efficiency. It is not a bioglass dental putty that must undergo a reaction i.e. biomimetic. Nano Paste has ultrafine particles that allow a huge surface area for new bone cells to migrate into and readily start osteosynthesis. Use for: TTA procedures, Nonunions, Arthrodesis, or Augmenting an autograft.

JOR338A	5gm	\$160.00/ea
---------	-----	-------------

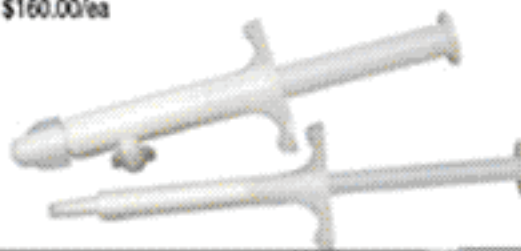

Large Animal Supplies

Gels, Milk Tubes & Rubber OB Apparel

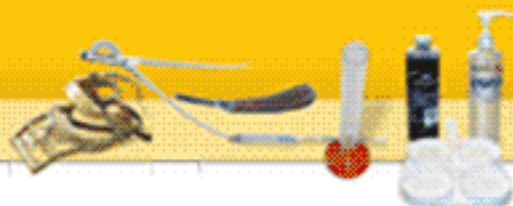

Cal-Gel® cartridge

a specially-formulated mineral supplement for use in dairy cows. It is an aid to maintaining normal calcium levels during the critical immediate pre-partum and post-partum periods. Cal-Gel comes in a standard dosing cartridge and is administered orally. Based on a Danish formulation used for over 20 years it delivers calcium together with magnesium and cobalt at a balanced pH.



JOR294 12 cartridges/display case. \$67.00/dz

BUY NOW



Milk Tubes

Self-retaining. Smooth retaining bulbs.

JOR278B	2 1/2", 1 dozen	\$21.00/dz
JOR278A	2", 1 dozen	\$21.00/dz
JOR278C	3", 1 dozen	\$21.00/dz



BUY NOW

Ketogel Jorvet

Ketogel™ is a concentrated energy gel packed with vitamins, amino acids, and trace minerals. It is designed to be used to help maintain normal blood glucose (sugar) during periods of stress (i.e., difficult calving and metritis). This stress period often leads to ketosis (acetonemia). The administration of an oral product often is a follow-up to an intravenous treatment of dextrose or glucocorticoids.

- Energy Source. Ketogel™ provides 290 grams of propylene glycol. This is rapidly absorbed directly from the rumen to the liver and converted to glucose.
- Vitamin A (40,000 Units), Vitamin D (10,000 Units), Vitamin E (100 Units). The ruminant is unable to synthesize these vitamins. There is an increased demand during periods of stress.
- Niacin (6 Grams) has a role in increasing glucose production and decreasing fat mobilization.
- Choline (6 Grams) and Methionine (6 Grams) are methyl group donors and have an important role in the regulation of fat deposition in the liver.
- Cobalt is a precursor of Vitamin B12. This is an important co-factor in glucose production.

JOR306 Dozen \$78.00/dz **BUY NOW**

Cartridge Dosing Gun

JOR294G \$40.50/ea **BUY NOW**



Rubberized OB Suit **BUY NOW**

Rubberized OB Suit. With pants and jacket.

JOR30SR-S	Small, (2 pc)	\$188.00/ea
JOR30SR-M	Medium (2pc)	\$183.00/ea
JOR30SR-XL	X-Large (2 pc)	\$183.00/ea

OB Rubber Smock **BUY NOW**

This smock features the special easy-to-clean arm shields. Very durable.

JOR30R-L	Large	\$125.00/ea
JOR30R-S	Small	\$110.00/ea
JOR30R-XL	X-Large	\$113.00/ea
JOR30R-M	Medium	\$113.00/ea

Rubberized OB Jacket **BUY NOW**

Rubberized OB Jacket only

JOR30JR-S	Small	\$110.00/ea
JOR30JRXL	X-Large	\$126.00/ea

Rubberized OB Overalls **BUY NOW**

Easy to snap-on Suspenders. Size XL.

JOR30OS	Small	\$110.00/ea
JOR30OM	Medium	\$110.00/ea
JOR30OL	Large	\$110.00/ea
JOR30OXL	X-Large	\$120.00/ea

Rubberized OB Pants **BUY NOW**

Rubberized OB Pants only.

JOR30PR-S	Small	\$73.00/ea
JOR30PR-L	Large	\$73.00/ea

JOR30JR & JOR30PR



Total OB Sleeve **BUY NOW**

The "Total" OB Sleeve. This new product gives additional coverage to the whole shoulder and under arm area. No need for clamps to hold in place or a separate shoulder protector. Helps reduce laundry expense and reduces accidental manure stains and smell. This glove is sensitive but strong, 1-mil thick with strong smooth seams. Package is 50 sleeves in a pull out dispensing box.



JOR300D	Regular (Box of 50)	\$21.00/bx
JOR300DS	Small (box of 50)	\$21.00/bx

Disposable Plastic Boots **BUY NOW**

Fits over cowboy boots and large work shoes. Handy tie feature keeps boots on tight. Blue.

JOR100BL Heavy 4 mil thickness. 21"H x 16"L. 50/bag. \$19.20/pk



Rubberized OB Apron **BUY NOW**

Rubberized OB Apron. Suitable for wearing in conjunction with JOR29 or JOR29c.

JOR29A Rubberized, 120cm or 48" L \$37.50/ea

OB Shoulder Protector **BUY NOW**

This is the original Danish import, where the arm passes through an opening in the special easy-to-clean rubber shield. There's no bunching of the material in the arm area. If worn in conjunction with a rubber apron, it serves as an OB smock. Protector ties under opposite arm.

JOR29 Heat-sealed seams \$45.00/ea

OB Shoulder Cuff **BUY NOW**

Basically the same as JOR29 above, but less area is covered. Very handy in conjunction with disposable or rubber sleeves.

JOR29C Heat-sealed seams \$33.00/ea

Spare Rubber Rings

Spare rubber rings for OB cuffs

JOR29D \$7.50/ea

BUY NOW

