



DISCOUNT MEDICAL SUPPLY CATALOG

CONTACT INFORMATION

PHONE 800.544.7521 (nationwide toll free)
847.680.3050 (local)
7:00 a.m.-6:00 p.m. Monday-Friday

FAX 800.204.2177 (24 hr. nationwide toll free)
847.680.4440 (local)

WEBSITE **WWW.SHOPMEDVET.COM**

EMAIL CUSTOMERSERVICE@SHOPMEDVET.COM

ADDRESS Med-Vet International
13822 West Boulton Blvd.
Mettawa, IL 60045



Dear Friends,

We would like to take this opportunity to thank you for your patronage. We appreciate all of our customers, whether they be current, past or potential customers. If you are considering a purchase from Med-Vet International, please call and speak with one of our friendly and knowledgeable customer service representatives.

Please let us know if you require a product that is not listed in our catalog. Chances are we will be able to obtain it for you at considerable savings over other companies.

At Med-Vet International, we keep our business family on a personal level to better serve your needs. From our family to yours, from our business to yours, thank you for choosing Med-Vet International.

Bill LaPietra,
President

Contents

PHARMACEUTICALS

NEW Products, Specials, Brand & Generic 2-39

SUTURE AND SKIN CLOSURE

Oasis, Ethicon, Skin Staplers, Tissue Adhesive, Braunamid Cassette Suture & Ligaton Clips and Appliers **SINGLE SUTURE CLOSEOUTS!** 40-53

SYRINGES & NEEDLES 3 PAGE Monoject BLOWOUT

MVI, Monoject, Excel Terumo, Ulticare, Bulb Syringes, Biopsy Needles Vaxi/Henke Drench Syringes, Henke Roux Syringe & Feeding Needles 54-70

INSTRUMENTS

Surgical Blades, Handles, Forceps, Scissors, Nail Nippers, Retractors, OB Orthopedic, Spay Packs, Instrument Packs, Spay Packs 71-109

SURGICAL AND EXAM ROOM SUPPLIES

Gowns, Masks, Instrument Wraps, Drapes, O.R. Towels Surgical Scrub Brushes, Alcohol & Thermometers 110-134

PET GROOMING AND RESTRAINTS

Underpads, Pet Carriers, Safe-T-Collars, Muzzles, Nail Nippers, Wahl® Clipper Products, Pet Rakes, Brushes, Wabbas®, Ziggies®, KONG® Balls, Rawhide Chews & Animal Leads 135-170

COTTON AND GAUZE PRODUCTS

Gauze Sponges, Cotton Roll, Cotton Balls, Lap Sponge, Stretch Gauze Rolls, Brown Gauze 171-173

GLOVES

Exam, Vinyl, Latex, Powder-Free, Nitrile, Aloe-touch®, Ansel, Surgical & Animal Handling 174-177

WOUND CARE

Cohesive Bandage, Tape (Elastic, Adhesive, Porous, Zonas & Waterproof) Adhesive Bandages and MoleSkin 178-181

SCRUBS AND APPAREL

Gowns, Shoecovers, Masks, Lab Coats & 99¢ SCRUBS (See Details) 182-197

VIALS AND CONTAINERS

Prescription Bottles, Graduated Ovals, Yorker Bottles, Sharps Containers, Specimen Containers, Cadaver Bags & Sundry Jars 198-201

I.V. ADMINISTRATION

IV Administration Sets, T-Connectors, Catheters & Infusion Sets 202-209

EQUIPMENT AND FURNISHINGS

Mayo & Instrument Trays, Stainless Steel, Aspiration Units, Animal Stretchers, Narcotic Cabinets, Gurneys, Utility Carts, Wet/Exam Tables & Cages 210-229

ORTHOPEDIC

Castling Tape, Fiberglass Tape, Cast Padding, Splints, Vet-Lite Cast, Fixation Kits, Cortical/Jorvet/Self Tapping Screws & Compression Plates 230-268

STERILIZATION

Sterilization Tubing, Autoclave Tape, Sterilization Pouches, Iodine Scrub and Solution, Air Deodorizer/Dispenser, Instrument Cleaner and Disinfectant, Ultrasonic Cleaning Solution, Instrument Brush, Disinfecting Wipes, Sterilizer and Ultrasonic cleaning unit. 269-276

DIAGNOSTIC EQUIPMENT AND SUPPLIES

Stethoscopes, Otoscopes, Ophthalmoscopes, Microscopes, Scales Blood Flow Monitors, Pulse Oximeters, Sphygmomanometers, Refractometers & Diagnostic Tests 277-297

ANESTHESIA SUPPLIES

Mobile Anesthesia Unit, Vaporizers, Anesthesia Masks, Breathing Bags, Resuscitation Bags, Endotracheal Tubes, Laryngoscope Blades, Handles & Anesthesia Circuits 298-315

LABORATORY SUPPLIES

Centrifuges, Serum and Blood Collection Tubes, Microscope Slides, Blood Rocker & Pipettes 316-326

X-RAY SUPPLIES

Aprons, Gloves, Thyroid Cover, Illuminator & Tape 327-329

MISCELLANEOUS AND REFERENCE

Anatomical Charts, Canine & Feline Models 330-334

DENTAL NEWLY EXPANDED!

Ultrasonic Scaler/Polisher, Elevators, & Scrapers 335-346

LARGE ANIMAL NEW SECTION!

Equine and Bovine Specialty Products: Drenchers, Large Specula Semen Products, Emasculators, Hoof Care/Supplies & Catheters 347-371

INDEX/FAX ORDER PAGE

A-Z 372-384

13822 WEST BOULTON BLVD. METTAWA, IL 60045

WWW.SHOPMEDVET.COM

Phone 800-544-7521

Fax 800-204-2177

Ears & Eyes



OPTI-VET EYE DROPS
0.5 oz
RXHY-OPTIC

\$10⁹⁹



I-DROP VET

Box of 20 Single Use Allets
RXEYEDROP-20

Vet Label

\$14⁵⁰



**POLYMYXIN B SULF AND TRIM
OPHTHALMIC SOLUTION**

10ml
RXTRIM-10

\$15⁵⁵



**CIPROFLOXACIN OPHTHALMIC
SOLUTION**

0.3%, 5ml
RXCIPRO-OPHS

\$3⁰⁰



BETAGEN OTIC SOLUTION
(Gentamicin, Betamethasone)

RXGEN-OTIC 7.5ml

\$3⁸³

Starting At

\$4²⁹

TRI-OTIC OINTMENT

(Gentamicin, Betamethasone, Clotrimazole)

RXOTO-7.5 7.5gm tube **\$4.29/ea**
RXOTO-15 15gm tube **\$6.69/ea**

EAR CLEANER

EAR CLEANER WITH ALOE
RXOTIC-JC 4oz bottle

\$2⁴⁵

DERMA-VET OINTMENT

(Neomycin, Nystatin, Thiostrepton, Triamcinolone)

RXDERMAVET 7.5ml **\$3.50/btl**
RXDERMAVET15 15ml **\$5.86/btl**



No returns on pharmaceuticals • Prices change frequently please call for current price • Shipping charges for refrigerated items are a flat charge based on your shipping zone. Customer accepts full responsibility for condition of products upon receipt. ❄ Indicates Refrigerated Shipping • Pictures are for graphic purposes only, actual product may be different.

Introducing Petrem™ Sevoflurane

The FIRST FDA approved generic Sevoflurane for veterinary use

SHOPMEDVET.COM is very pleased to announce that we offer the FIRST generic sevoflurane approved by the U.S. Food and Drug Administration's Center for Veterinary Medicine. In addition, it is manufactured right here in the United States by Piramal Healthcare* in Bethlehem, Pennsylvania. Piramal Healthcare is an international company with inhalation anesthetic manufacturing expertise and is one of only three companies worldwide that has approval to market sevoflurane.

In addition to significant savings, a quality product and continued customer service, we are offering a "ZERO HASSLE - ZERO COST" vaporizer program to all customers that are interested in purchasing Petrem™ Sevoflurane. This vaporizer program allows both current sevoflurane users and potential NEW sevoflurane users to have access to brand new Tec-3 style vaporizers at no additional cost.

The NEW Tec-3 style vaporizer comes with a full 10 year warranty! These vaporizers are pre-calibrated, ready for installation and use right out of the box. Additionally, these NEW Tec-3 style vaporizers have the capacity to hold a FULL 250ml bottle of sevoflurane! Previous Tec-3 style vaporizers were only capable of holding 120-140mls. Since a whole 250ml bottle will fit into your new vaporizer, your facility will not have open bottles sitting around eliminating the potential for spills and waste.

The "ZERO HASSLE - ZERO COST" program is a great opportunity for facilities that want to use sevoflurane for the FIRST time! After enrollment in our program you will not need to purchase a vaporizer, buy a bunch of product upfront OR pay for expensive training. By participating in our program your facility will have access to New Vaporizers at No Cost and there are NO large upfront sevoflurane purchase requirements. Your facility will also have access to all of Piramal Healthcare's technical support team and training resources!

If your facility is already using sevoflurane you STILL can benefit from this program! If you are currently purchasing sevoflurane and interested in saving money; just switch to the generic Petrem™ sevoflurane and continue to purchase product, as needed. Your facility will qualify to receive brand new sevoflurane Tec-3 style vaporizers based on your current usage. These new vaporizers can be used to either replace old vaporizers OR expand your clinic so you can add sevoflurane to additional or new surgical areas.

If you are interested in our "ZERO HASSLE - ZERO COST" program and would like more details please contact our customer service department or your local sales representative!

ZERO HASSLE! - ZERO COST!



FREE Vaporizer

Isoflurane Inhalant Anesthetic

A non-flammable, non-explosive Inhalation anesthetic.

RXISO-100 100ml \$9.99
RXISO-250 250ml \$21.50

Starting at:

\$9.99



No returns on pharmaceuticals • Prices change frequently please call for current price • Shipping charges for refrigerated items are a flat charge based on your shipping zone. Customer accepts full responsibility for condition of products upon receipt. ❄️ Indicates Refrigerated Shipping • Pictures are for graphic purposes only, actual product may be different.

13822 WEST BOULTON BLVD. METTAWA, IL 60045

WWW.SHOPMEDVET.COM

Phone 800-544-7521

Fax 800-204-2177

DERMABENSS SHAMPOO

RXDERBEN-8 12oz

\$7.50**DERMALYTE SHAMPOO**

RXDERMHY-SH 12oz

\$5.99/btl

RXDERMHY-G gallon

\$41.99/gl

\$5.99**EICOSADERM**

RXEICO-8

EPA 360mg/DHA
240mg, 8oz**\$12.25****DERMALLAY SHAMPOO**

RXDERM-SHAM 12oz

\$5.99**DERMALLAY OATMEAL SHAMPOO**

RXDERM-OSHAM-GA

gallon

\$54.60/gl

**MALACETIC OTIC**

RXMALOTIC-4 4oz

\$6.32/btl

RXMALOTIC-16 16oz

\$14.99/btl

**MALACETIC SHAMPOO**

RXMAL-SHM12 12oz

\$6.99/btl

RXMAL-SHM16 16oz

\$9.99/btl

Starting At

\$6.99**MALACETIC WET WIPES**

RXMAL-WIPE 5" x 9" Wipes, 25/pack

\$7.29**LIME PLUS DIP**

RXLYMDYP-16 16oz

\$8.49/btl

RXLYMDIP-GAL 1 gallon

\$69.99/gl

**MAL-A-KET SHAMPOO**

Mal-A-Ket Shampoo is a unique, pleasant-smelling, antifungal, antibacterial, deodorizing, degreasing shampoo. Contains 1% ketoconazole (antifungal) and 2% chlorhexidine (antimicrobial) with 2% acetic acid. Acetic acid potentiates and stabilizes the ketoconazole and has primary antimicrobial, antifungal properties, as well as excellent degreasing, cleansing and coat-conditioning qualities. This potent combination has a wider antibacterial activity against Gram-negative and Gram-positive organisms.

RXMAL-KET8 8oz

\$9.27/btl



No returns on pharmaceuticals • Prices change frequently please call for current price • Shipping charges for refrigerated items are a flat charge based on your shipping zone. Customer accepts full responsibility for condition of products upon receipt. ❄ Indicates Refrigerated Shipping • Pictures are for graphic purposes only, actual product may be different.

AMOXICILLIN POWDER FOR SUSPENSION

RXAMS250-100 250mg/5ml, 100ml \$3.81/btl
 RXAMS250-150 250mg/5ml, 150ml \$3.25/btl

AMOXICILLIN CAPSULES

Starting At

\$35⁷⁰

RXAMO250-500 250mg, 500 capsules \$35.70/btl
 RXAMO500-500 500mg, 500 capsules \$47.50/btl

AMOXICILLIN/CLAVULANIC ACID TABLETS

RXAUG875 875/125mg, 20 tablets
 RXAUG500 500/125mg, 20 tablets

\$22⁵⁰

AZITHROMYCIN ORAL SUSPENSION

Starting At

\$12⁷⁹

RXZITH200-30 200mg/5ml, 30ml \$12.79/btl
 RXZITH-ZPAC3 250mg, 3x6 tablets/pack \$11.50/pk



CEFAZOLIN INJECTION

1 gram vial RXCEF1GM-V

\$12²⁵

**TOP
SELLER**

CEPHALEXIN CAPSULES

RXCEP250-500 250mg, 500 capsules \$42.85/btl
 RXCEP500-500 500mg, 500 capsules \$48.50/btl



CLINDAMYCIN HCL CAPSULES

150mg, 100 capsules
 RXCLI150-100



\$10⁹⁹

DOXYCYCLINE TABLETS

RXDOX100-50T 100mg, 50 tablets \$4.00/btl
 RXDOX100-500T 100mg, 500 tablets \$26.50/btl



CIPROFLOXACIN TABLETS

RXCIPRO-250 250mg, 100 tablets \$14.50/btl
 RXCIPRO-750-50 750mg, 50 tablets \$15.50/btl
 RXCIPRO-500 500mg, 100 tablets \$17.99/btl



SULFA/TRIMETHOPRIM (SMZ)

RXSMZDS-100 Double Strength, 800/160mg, 100 tablets \$9.99/btl
 RXSMZDS-500 Double Strength, 800/160mg, 500 tablets \$31.43/btl



Antibiotics

No returns on pharmaceuticals • Prices change frequently please call for current price • Shipping charges for refrigerated items are a flat charge based on your shipping zone. Customer accepts full responsibility for condition of products upon receipt. ❄ Indicates Refrigerated Shipping • Pictures are for graphic purposes only, actual product may be different.

13822 WEST BOULTON BLVD. METTAWA, IL 60045

WWW.SHOPMEDVET.COM
Phone 800-544-7521
Fax 800-204-2177

Verruca Freeze

This convenient alternative to liquid nitrogen effectively treats benign skin lesions and is the coldest portable cryosurgical system on the market, freezing at -70C (-94F).

Physician's authorization is required to purchase this item.



VERRUCA-FREEZE KITS

RXVERRUCA starter kit: 60-70 freezes with cones and buds
 RXVERRUCA-MINI mini kit: 30-35 freezes with cones and buds

Mini Kit **\$212⁰⁰** Regular Kit **\$331⁰⁰**

RE-FILLS

RXVERRUCA-REF Refill Canister: 60-70 freezes
 RXVERRUCA-MINIR mini replacement canister: 30-35 freezes

Starting At
\$159⁰⁰

CRYO BUDS

RXVERRUCA-S Cryo Buds small, 2mm, 30/pk **\$31.00**
 RXVERRUCA-M Cryo Buds medium 4-6mm, 30/pk **\$31.00**
 RXVERRUCA-L Cryo Buds large, 8-10mm, 30/pk **\$31.00**

SOFT TIP CONES

RXVERRUCA-CONES Soft tip cones, 5/pk

\$79⁰⁰

CRYO SURGERY, INC.

Gebauers Ethyl Chloride

A Proven Topical Anesthetic

Gebauer's Ethyl Chloride topical anesthetic skin refrigerant is intended to control the pain associated with injections, starting IV's and venipuncture, minor surgical procedures, and the temporary relief of minor sports injuries.

Gebauer's Ethyl Chloride

RXETHYL-FINE Fine Spray, 3.5oz **\$36.25/btl**
 RXETHYL-CHLO Medium Spray, 3.5oz **\$39.50/btl**



No returns on pharmaceuticals • Prices change frequently please call for current price • Shipping charges for refrigerated items are a flat charge based on your shipping zone. Customer accepts full responsibility for condition of products upon receipt. ❄️ Indicates Refrigerated Shipping • Pictures are for graphic purposes only, actual product may be different.

13822 WEST BOULTON BLVD. METTAWA, IL 60045

WWW.SHOPMEDVET.COM

Phone 800-544-7521

Fax 800-204-2177

Vetoryl Capsules



Benefits:

- Improvement may be seen within several weeks
- Available in 10mg, 30 mg or 60 mg tablets (based on weight)

How it works:

Vetoryl contains a drug that controls the adrenal gland's excess production of cortisol, a hormone released into the bloodstream during times of stress.

VETORYL (TRILOSTANE)

| | | |
|-------------|-------------------|-------------|
| RXVETORYL10 | 10mg, 30 capsules | \$34.29/btl |
| RXVETORYL30 | 30mg, 30 capsules | \$42.86/pk |
| RXVETORYL60 | 60mg, 30 capsules | \$55.71/pk |

Fatal Plus & DEA 222 Form

FATAL-PLUS®

Produces classic euthanasia by sequentially depressing the cerebral cortex, the lungs and the heart.

Action on target organs gives humane euthanasia of unparalleled speed, effectiveness and specificity. Instant unconsciousness is induced with simultaneous collapse of the animal.

Deep pentobarbital anesthesia ensues with blood pressure fall, stoppage of breathing and cerebral death. Cardiac function stops, quickly and irreversibly.

FATAL-PLUS SOLUTION

RXFATAL-PLUS 390mg/ml, 250ml

\$59⁹⁹/btl



Instructions for completing a: DEA 222 form to order Schedule 2 and 2n Controlled Substances

Fill in Date

Address on Form

Address on Envelope

Signature required or form is invalid

Last Line Completed: Enter only the number of lines used. In the example above, the last line completed would be 3.

Address on Envelope

SAVE THIS WITH YOUR 222 ORDER FORMS FOR FUTURE REFERENCE

Last Line Completed: Enter only the number of lines used. In the example above, the last line completed would be 3.

Listed below is detailed information to help you in filling out the DEA form 222 for class 2 and 2n drugs. This is only to be used in ordering class 2 and 2n drugs.

- Product will be shipped to the address on the dea license only
- Form 222 can contain no corrections or strike-over marks
- Use the following Med-Vet International address on the request form:
13822 W Boulton Blvd. Mettawa, IL 60045
- Please keep customer copy (blue copy) and mail remaining copies for processing to: **13822 W Boulton Blvd. Mettawa, IL 60045**
- Be sure to refer to the back of the blue copy of your 222 form for complete instructions



No returns on pharmaceuticals • Prices change frequently please call for current price • Shipping charges for refrigerated items are a flat charge based on your shipping zone. Customer accepts full responsibility for condition of products upon receipt. ❄ Indicates Refrigerated Shipping • Pictures are for graphic purposes only, actual product may be different.

| Product | Size/Details | Product Code | Vet Label | RX | Brand | DEA |
|--|--|------------------|-----------|----|-------|-----|
| 0.45% Sodium Chloride for Injection | 1 liter bag | RX00.45NACL-K | | ✓ | | |
| 0.9% Bacteriostatic Sodium Chloride Injection | 10ml vial, Bacteriostatic | RX00.9NACL-10BAC | | ✓ | | |
| | 30ml vial, Bacteriostatic | RX00.9NACL-30BAC | | ✓ | | |
| 0.9% Sodium Chloride for Irrigation | 250ml bottle | RX00.9NACL-250IR | | ✓ | | |
| | 1000ml pour bottle | RXSAL-POD1LT | | ✓ | | |
| 0.9% Sodium Chloride Injection | 10ml vial | RX00.9NACL-10 | | ✓ | | |
| | 50ml vial | RX00.9NACL-50 | | ✓ | | |
| | 100ml bag, 4 bags/pack | RX00.9NACL-100 | | ✓ | | |
| | 250ml bag | RX00.9NACL-250ML | | ✓ | | |
| | 500ml bag | RX00.9NACL-500ML | | ✓ | | |
| | 1000ml bag | RX00.9NACL-K | | ✓ | | |
| | 3000 ml/bag, 4 bags/cs | RX00.9NACL-3K | | ✓ | | |
| Acarexx for Ear Mites | 12/box | RXACAREXX | ✓ | ✓ | ✓ | |
| Accelerator | 8oz | RXACCELERATOR | ✓ | ✓ | ✓ | |
| Acepromazine Injection | 10mg/ml, 50ml | RXACE-50V | ✓ | ✓ | | |
| Acepromazine Tablets | 10mg, 100 tablets | RXACE10-100 | ✓ | ✓ | | |
| | 10mg, 500 tablets | RXACE10-500 | ✓ | ✓ | | |
| | 25mg, 100 tablets | RXACE25-100 | ✓ | ✓ | | |
| | 25mg, 500 tablets | RXACE25-500 | ✓ | ✓ | | |
| Acetaminophen Childrens Liquid | 160mg/5ml, 4oz | RXACETAM-LIQ | | | | |
| Acetazolamide | 250mg, 100 tablets | RXACETAZ-250 | | ✓ | | |
| Acyclovir | 200mg, 100 capsules | RXACY200-100 | | ✓ | | |
| | 400mg, 100 tablets | RXACY400-100 | | ✓ | | |
| Adam's Flea & Tick Shampoo | gallon | RXFLTI-GAL | ✓ | | ✓ | |
| Adam's Flea & Tick Spray | 16oz | RXFLTI-MIST | ✓ | | ✓ | |
| | 32oz | RXFLTI-MIST32 | ✓ | | ✓ | |
| Adams Freedom Spot On | small dog, less than 33lbs, 3 month | RXFREEDOM-SM | ✓ | | ✓ | |
| | Large dog, 33-65lbs, 3 month | RXFREEDOM-LG | ✓ | | ✓ | |
| | X-large dog, greater than 65lbs, 2 month | RXFREEDOM-XL | ✓ | | ✓ | |
| Adenosine Injection | 3mg/ml, 2ml | RXADENOSINE | | ✓ | | |
| Adequan Canine | 5ml vial, 2 per box | RXADEQ-K9 | ✓ | ✓ | ✓ | |
| Adequan Equine | IM, 5ml vial | RXADEQ-EQ | ✓ | ✓ | ✓ | |
| Adriamycin Injection * | 50mg, 25ml | RXADR50-25 | | ✓ | | |
| | 200mg, 100ml | RXADR200-100 | | ✓ | | |
| Advantage For Cats | orange, 1-9lbs, 4 per box | RXADV-OR-4 | ✓ | | ✓ | |
| | purple, 9-18lbs, 4 per box | RXADV-PU-4 | ✓ | | ✓ | |
| Advantage For Dogs | green, 1-10lbs, 4 per box | RXADV-GR-4 | ✓ | | ✓ | |
| | teal, 11-20lbs, 4 per box | RXADV-TE-4 | ✓ | | ✓ | |
| | red, 21-55lbs, 4 per box | RXADV-RE-4 | ✓ | | ✓ | |
| | blue, 55-100lbs, 4 per box | RXADV-BL-4 | ✓ | | ✓ | |
| Advantage Multi for Cats | purple, 9.1-18lbs, 6 pack | RXADV-MULT-P | ✓ | ✓ | ✓ | |
| | Green, up to 10lbs, 6pk | RXADV-MULT-G | ✓ | ✓ | ✓ | |
| Advantage Multi for Dogs | teal, 9.1-20lbs, 6 pack | RXADV-MULT-T | ✓ | ✓ | ✓ | |
| | red, 20.1-55lbs, 6 pack | RXADV-MULT-R | ✓ | ✓ | ✓ | |
| | Blue, 55.1-88lbs, 6pk | RXADV-MULT-B | ✓ | ✓ | ✓ | |



No returns on pharmaceuticals • Prices change frequently please call for current price • Shipping charges for refrigerated items are a flat charge based on your shipping zone. Customer accepts full responsibility for condition of products upon receipt. ❄️ Indicates Refrigerated Shipping • Pictures are for graphic purposes only, actual product may be different.



13822 WEST BOULTON BLVD. METTAWA, IL 60045

WWW.SHOPMEDVET.COM

Phone 800-544-7521

8

Fax 800-204-2177

| Product | Size/Details | Product Code | Vet Label | RX | Brand | DEA |
|---|---|-----------------|-----------|----|-------|-----|
| Advantix K9  | green, 0-10 lbs, 6pk | RXADVANTIX-GR6 | ✓ | | ✓ | |
| | teal, 11-20lbs 6pk | RXADVANTIX-TE6 | ✓ | | ✓ | |
| | red, 21-55lbs, 6pk | RXADVANTIX-RE6 | ✓ | | ✓ | |
| | blue, over 55lbs, 6pk | RXADVANTIX-BL6 | ✓ | | ✓ | |
| AK-Con Ophthalmic Solution | 0.1%, 15ml | RXAK-CON | | ✓ | | |
| Albon Oral Suspension | 5%, 473ml | RXALBON-5 | ✓ | ✓ | ✓ | |
| Albon Tablets | 125mg, 200 tablets | RXALBON125-200 | ✓ | ✓ | ✓ | |
| | 500mg, 100 tablets | RXALBON500-100 | ✓ | ✓ | ✓ | |
| Albuterol Inhalation Solution | 0.83%, 25x3 | RXALB25X3 | | ✓ | | |
| | 0.5%, 20ml | RXALB-SOL-20 | | ✓ | | |
| Albuterol Sulfate | 4mg, 500 tablets | RXALB4-500 | | ✓ | | |
| Allergroom Shampoo | 8oz | RXALLERGROOM8 | ✓ | | ✓ | |
| Allergy Relief Wipes | 8/pack | RXWIPES-ALLERGY | ✓ | | | |
| Allopurinol | 100mg, 100 tablets | RXALL100-100 | | ✓ | | |
| | 300mg, 100 tablets | RXALL300-100 | | ✓ | | |
| | 300mg, 500 tablets | RXALL300-500 | | ✓ | | |
| Aloe and Oatmeal Shampoo | 16oz | RXSHAMP-AO16 | ✓ | | | |
| Alpha Trak Lancets | 25 gauge, 100 per box | RXALPHA-LANCET | ✓ | ✓ | ✓ | |
| Alpha-Trak Kit  | includes: blood glucose meter plus a vial of test strips, 2 bottles of control solution, a box of lancets, a quick users guide, a diabetes diary and an instructional DVD | RXALPHATRAK-KIT | ✓ | ✓ | ✓ | |
| AlphaTrak Test Strips | 50/pack | RXALPHA-TRAK | ✓ | ✓ | ✓ | |
| Alprazolam (CIV) Tablets | 0.25mg, 100 tablets | RXANAX.25-100 | | ✓ | | CIV |
| | 0.5mg, 100 tablets | RXANAX0.5-100 | | ✓ | | CIV |
| | 1mg, 100 tablets | RXANAX1-100 | | ✓ | | CIV |
| Aluminum Hydrox Gel Conc. | 600mg/5ml, 12oz | RXALTERNAGEL-12 | | | | |
| Amforol | 100 tablets | RXAMFOROL-100 | ✓ | ✓ | ✓ | |
| Amidate (Etomidate) | 20mg, 10ml amp, 10/box | RXAMIDATE | | ✓ | | |
| Aminocaproic Acid Injection | 250mg/ml, 25 x 20ml vial | RXAMICAR | | ✓ | | |
| Aminophylline Tablets | 100mg, 100 tablets | RXAMI100-100 | | ✓ | | |
| | 100mg, 1000 tablets | RXAMI100-K | | ✓ | | |
| | 200mg, 1000 tablets | RXAMI200-K | | ✓ | | |
| Amiodarone HCl Injection | 50mg/ml, 3ml, 10 per box | RXAMIODAR10X3 | | ✓ | | |
| Amitriptyline | 10mg, 100 tablets | RXAMIT10-100 | | ✓ | | |
| | 25mg, 100 tablets | RXAMIT25-100 | | ✓ | | |
| | 50mg, 100 tablets | RXAMIT50-100 | | ✓ | | |
| Amlodipine Besylate Tablets | 2.5mg, 90 tablets | RXAMILOD2.5-90 | | ✓ | | |
| | 5mg, 90 tablets | RXAMILOD5-90 | | ✓ | | |
| | 10mg, 90 tablets | RXAMILOD10-90 | | ✓ | | |
| | 10mg, 1000 tablets | RXAMILOD10-1000 | | ✓ | | |
| Ammonia Inhalants  | 0.33ml ampules, 10/pk | RXAMMONIA | | ✓ | | |
| Amoxi-Tabs | 50mg, 500 tablets | RXAMOTAB-50 | ✓ | ✓ | ✓ | |
| | 100mg, 500 tablets | RXAMOTAB-100 | ✓ | ✓ | ✓ | |
| | 400mg, 250 tablets | RXAMOTAB-400 | ✓ | ✓ | ✓ | |

No returns on pharmaceuticals • Prices change frequently please call for current price • Shipping charges for refrigerated items are a flat charge based on your shipping zone. Customer accepts full responsibility for condition of products upon receipt. ❄️ indicates Refrigerated Shipping • Pictures are for graphic purposes only, actual product may be different.

| Product | Size/Details | Product Code | Vet Label | RX | Brand | DEA |
|---|---------------------------------|-----------------|-----------|----|-------|-----|
| Amoxicillin Capsules  | 250mg, 100 capsules | RXAM0250-100 | | ✓ | | |
| | 250mg, 500 capsules | RXAM0250-500 | | ✓ | | |
| | 500mg, 100 capsules | RXAM0500-100 | | ✓ | | |
| | 500mg, 500 capsules | RXAM0500-500 | | ✓ | | |
| Amoxicillin Drops | 50mg/ml, 15ml | RXAM0X1-DR15 | ✓ | ✓ | | |
| | 50mg/ml, 30ml | RXAM0X1-DR30 | ✓ | ✓ | | |
| Amoxicillin Powder for Suspension | 125mg/5ml, 100ml | RXAMS125-100 | | ✓ | | |
| | 250mg/5ml, 100ml | RXAMS250-100 | | ✓ | | |
| | 250mg/5ml, 150ml | RXAMS250-150 | | ✓ | | |
| Amoxicillin Tablets | 125mg, 100 tablets | RXAM0125-100 | | ✓ | | |
| Amoxicillin/Clavulanic Acid Suspension | 400/57mg/5ml, 50ml | RXAUGS400-50 | | ✓ | | |
| | 400/57mg/5ml, 75ml | RXAUGS400-75 | | ✓ | | |
| | 400/57mg/5ml, 100ml | RXAUGSUS400-100 | | ✓ | | |
| Amoxicillin/Clavulanic Acid Tablets | 200/28.5mg, 20 chewable tablets | RXAUG200 | | ✓ | | |
| | 400/57mg, 20 tablets | RXAUG400 | | ✓ | | |
| | 500/125mg, 20 tablets | RXAUG500 | | ✓ | | |
| | 875/125mg, 20 tablets | RXAUG875 | | ✓ | | |
| Ampicillin (Polyflex) Injection | 25 gram | RXAMP25GM-IN | ✓ | ✓ | ✓ | |
| Ampicillin Capsules  | 250mg, 100 capsules | RXAMP250-100 | | ✓ | | |
| | 250mg, 500 capsules | RXAMP250-500 | | ✓ | | |
| | 500mg, 100 capsules | RXAMP500-100 | | ✓ | | |
| | 500mg, 500 capsules | RXAMP500-500 | | ✓ | | |
| Ampicillin Injection | 500mg vial, 10 pack | RXAMP500MG-INJ | | ✓ | | |
| | 1gm vial, 10 per box | RXAMP1GM-INJ | | ✓ | | |
| Animax Cream | 7.5gm | RXANIMC-7.5 | ✓ | ✓ | ✓ | |
| | 15gm | RXANIMC-15 | ✓ | ✓ | ✓ | |
| Animax Ointment  | 7.5ml | RXANIM-7.5ML | ✓ | ✓ | ✓ | |
| | 15ml | RXANIM-15ML | ✓ | ✓ | ✓ | |
| | 30ml | RXANIM-30ML | ✓ | ✓ | ✓ | |
| | 240ml | RXANIM-240ML | ✓ | ✓ | ✓ | |
| Anipryl | 5mg, 30 tablets | RXANIS-30 | ✓ | ✓ | ✓ | |
| | 10mg, 30 tablets | RXANI10-30 | ✓ | ✓ | ✓ | |
| | 15mg, 30 tablets | RXANI15-30 | ✓ | ✓ | ✓ | |
| | 30mg, 30 tablets | RXANI30-30 | ✓ | ✓ | ✓ | |
| Anti-Diarrhea Liquid | 4 oz | RXDIA-4OZ | ✓ | | | |
| Antirobe Aquadrops | 25mg/ml, 20ml | RXANTIROBE | ✓ | ✓ | ✓ | |
| Antirobe Capsules | 25mg, 600 capsules | RXANTIROBE25 | ✓ | ✓ | ✓ | |
| | 75mg, 200 capsules | RXANTIROBE75 | ✓ | ✓ | ✓ | |
| | 150mg, 100 capsules | RXANTIROBE150 | ✓ | ✓ | ✓ | |
| Antisedan (atipamezole) Injection | 5mg/ml, 10ml | RXANTISEDAN-10 | ✓ | ✓ | ✓ | |
| Anzemet Injection | 500mg/25ml | RXANZEMET | | ✓ | ✓ | |
| Arnica Ointment | 3.5oz | RXARNICA | | | | |
| Artificial Tear Ointment | 3.5gm | RXPARALUBE-O | | | | |
| Artificial Tears | 15ml | RXTEARS | | | | |
| Aspirin Powder | 1lb | RXASPIR-POWDER | ✓ | | | |
| Aspirin Powder Apple Flavored | 1lb | RXFLAV-ASPIR | ✓ | | | |
| Aspirin, Baby | 81mg, 36 chewable tablets | RXASPIRIN81BABY | | | | |
| Aspirin, Enteric Coated | 81mg, 120 tablets | RXASPIRIN81 | | | | |

No returns on pharmaceuticals • Prices change frequently please call for current price • Shipping charges for refrigerated items are a flat charge based on your shipping zone. Customer accepts full responsibility for condition of products upon receipt. ❄️ Indicates Refrigerated Shipping • Pictures are for graphic purposes only, actual product may be different.

| Product | Size/Details | Product Code | Vet Label | RX | Brand | DEA |
|---|--|-----------------|-----------|----|-------|-----|
| Atenolol Tablets | 25mg, 100 tablets | RXATENOL25 | | ✓ | | |
| | 25mg, 1000 tablets | RXATEN25-1000 | | ✓ | | |
| Atracurium | 10mg/ml, 5ml, 10/pack | RXATRACURIUM | | ✓ | | |
| Atropine Sulfate Injection | 15mg/ml, 100ml, large animal | RXATRINJ-LARGE | ✓ | ✓ | | |
| | 1/120 grain, 100ml | RXATRINJ-100 | ✓ | ✓ | | |
| Atropine Sulfate Ophthalmic Ointment | 1%, 3.5gm | RXATROPINE | | ✓ | | |
| Atropine Sulfate Ophthalmic Solution | 1%, 5ml | RXATROPH-5 | | ✓ | | |
| | 1%, 15ml | RXATROPH-15 | | ✓ | | |
| Azathioprine Tablets | 50mg, 100 tablets | RX0MURAN | | ✓ | | |
| Azithromycin Oral Suspension | 200mg/5ml, 15ml | RXZITH200-15 | | ✓ | | |
| | 200mg/5ml, 30ml | RXZITH200-30 | | ✓ | | |
| Azithromycin Tablets | 250mg, 30 tablets | RXZITH250-30 | | ✓ | | |
| | 250mg, 1x6 tablets/pack | RXZITH-ZPAC | | ✓ | | |
| | 250mg, 3x6 tablets/pack | RXZITH-ZPAC3 | | ✓ | | |
| Azodyl * | 60 Tablets | RXA200YL | ✓ | ✓ | ✓ | |
| Azopt Ophthalmic Solution | 10ml | RXAZOPT-10ML | | ✓ | ✓ | |
| Bacitracin Foil Packs | 500u/gm, 0.03oz foil pack, 144 packs/box | RXBAC-FOILPAK | | ✓ | | |
| Bacitracin Ointment | 500units, 1oz | RXBAC500-10Z | | | | |
| Baclofen Tablets | 10mg, 100 tablets | RXBACLOFEN10MG | | ✓ | | |
| Bacto Vite Plus | 10 oz. tube | RXBAC-VITE | ✓ | | ✓ | |
| Bag Balm | 10oz | RXBAG-BALM | | | | |
| Banamine Paste | 1500mg, 30gm | RXBANA-PASTE | ✓ | ✓ | ✓ | |
| Barium | 12oz | RXBARIUM-12 | | | | |
| Baytril Injection | 22.7mg/ml, 20ml | RXBAY22.7-INJ | ✓ | ✓ | ✓ | |
| | 100mg/ml, 100ml | RXBAYTRIL | ✓ | ✓ | ✓ | |
| Baytril Otic Drops | 15ml | RXBAY-OTIC15 | ✓ | ✓ | ✓ | |
| | 30ml | RXBAY-OTIC30 | ✓ | ✓ | ✓ | |
| Baytril Taste Tabs | 22.7mg, 100 tablets | RXBAY227-100 | ✓ | ✓ | ✓ | |
| | 22.7mg, 500 tablets | RXBAY22.7-500 | ✓ | ✓ | ✓ | |
| | 68mg, 50 tablets | RXBAY68-50 | ✓ | ✓ | ✓ | |
| | 68mg, 250 tablets | RXBAY68-250 | ✓ | ✓ | ✓ | |
| | 136mg, 50 tablets | RXBAY136-50 | ✓ | ✓ | ✓ | |
| | 136mg, 200 tablets | RXBAY136-200 | ✓ | ✓ | ✓ | |
| Benazepril Tablets | 5mg, 100 tablets | RXBENAZEPRIL5MG | | ✓ | | |
| | 10mg, 100 tablets | RXBENAZ10-100 | | ✓ | | |
| | 20mg, 100 tablets | RXBENAZ20-100 | | ✓ | | |
| Bene-Bac Bird Gel | 4 pack | RXBENEBAC-BIRD | ✓ | | ✓ | |
| Bene-Bac Cat Gel | 4 pack | RXBENEBAC-CAT | ✓ | | ✓ | |
| Bene-Bac Dog Gel | 4 pack | RXBENEBAC-DOG | ✓ | | ✓ | |
| Benzalkonium Chloride Aqueous Solution | 16oz | RXBENZ-AQ16 | | | | |
| Betagen (gentamicin, betamethasone) Topical Spray | 60ml | RXGEN-TOP | ✓ | ✓ | | |
| | 120ml | RXGEN-TOP120 | ✓ | ✓ | | |
| | 240ml | RXGEN-TOP240 | ✓ | ✓ | | |



No returns on pharmaceuticals • Prices change frequently please call for current price • Shipping charges for refrigerated items are a flat charge based on your shipping zone. Customer accepts full responsibility for condition of products upon receipt. ❄️ indicates Refrigerated Shipping • Pictures are for graphic purposes only, actual product may be different.



| Product | Size/Details | Product Code | Vet Label | RX | Brand | DEA |
|--|---|-----------------|-----------|----|-------|-----|
| Betagen Otic Solution | 7.5ml | RXGEN-OTIC | ✓ | ✓ | | |
| | 15ml | RXGEN-OTIC15 | ✓ | ✓ | | |
| | 240ml | RXGEN-OTIC240 | ✓ | ✓ | | |
| Bethanechol Chloride Tablets | 5mg, 100 tablets | RXBETHAN5-100 | | ✓ | | |
| Beuthanasia (CIII) Solution | 100ml | RXBEUTH-100 | ✓ | ✓ | ✓ | CII |
| Biofreeze | Roll-On, 3oz | RXBIOFREEZE-RO | | ✓ | ✓ | |
| | Tube, 4oz | RXBIOFREEZETUBE | | ✓ | ✓ | |
| | Spray, 4oz | RXBIOFREEZE-SP | | ✓ | ✓ | |
| Biotene Antiseptic Oral Gel | 1oz tube, 6 tubes/pk | RXBIOGEL-6 | ✓ | | ✓ | |
| Biotene Therapeutic Mouth Spray | 4oz bottle | RXBIOSPR-4 | ✓ | | ✓ | |
| Biotin | 800mcg, 110 tablets | RXBIOTIN800 | | | | |
| BIPS | 1dose/pk, 1 large capsule | RXBIPS-LC/1 | ✓ | | | |
| BIPS Dual Pack | 2 doses/pk, 1 large and 1 small capsule | RXBIPS-DP/1 | ✓ | | | |
| Bis-Co-Sorb | 60ml syringe | RXBCS-PET | ✓ | | | |
| | Gallon | RXBCS-G | ✓ | | | |
| Bis-Co-Sorb Equine | 60ml | RXBCS-EQ | ✓ | | | |
| Bismuth subsalicylate | gallon | RXPEPTO-BISM | ✓ | | | |
| Bitter Rid Spray | 4 oz bottle | RXBIT-4 | ✓ | | | |
| Bo-Se Injection | 100ml | RXBO-SE | ✓ | ✓ | ✓ | |
| Brewer's Yeast | 1lb | RXBREWY-1LB | ✓ | | | |
| Brilliance Flea and Tick Shampoo | 1 gallon | RXFLTI-SHAM | ✓ | | | |
| Brimonidine Tartrate Ophthalmic Solution | 0.2%, 15ml | RXBRIMOPH-15 | | ✓ | | |
| Bumetanide Tablets | 1mg, 100 tablets | RXBUMEX | | ✓ | | |
| Bupivacaine HCl Injection | 0.25%, 50ml | RXMARC-0.25 | | ✓ | | |
| | 0.5%, 50ml | RXMARCAINE-P | | ✓ | | |
| Bupivacaine with Epinephrine Injection | 0.25%, 1:200,000 50ml | RXBUPI-EPI | | ✓ | | |
| | 0.5%, 1:200,000 50ml | RXBUPI-EPI5 | | ✓ | | |
| Bupropion HCL | 75mg, 100 tablets | RXBUPROP75-100 | | ✓ | | |
| Buscopan Injection | 20mg/ml, 50ml | RXBUSOP-50 | ✓ | ✓ | ✓ | |
| Buspirone HCl | 5mg, 100 tablets | RXBUSP5-100 | | ✓ | | |
| | 10mg, 100 tablets | RXBUSP10-100 | | ✓ | | |
| Butalbital Asp/Caf (CIII) with Codeine Tablets | 100 capsules | RXFIORINAL-COD | | ✓ | | CII |
| Calcium Antacid | 150 tablets, assorted fruit flavors | RXTUMS | | | | |
| Calcium Antacid EX | 96 tablets, berry flavor | RXTUMS-EX | | | | |
| Calcium Chloride Injection | 10%, 10ml sdv | RXCAL-CHLOR | | ✓ | | |
| Calcium Gluconate | 10%, 10ml | RXCALGLU-10 | | ✓ | | |
| Calf-Guard * | 25 dose | RXCALF-GUARD | ✓ | ✓ | ✓ | |
| Capstar Tablets | blue, 2-25lbs, 6/pk | RXCAPS-BL | ✓ | | ✓ | |
| | green, over 25lbs, 6/pk | RXCAPS-GR | ✓ | | ✓ | |
| | blue, 2-25lbs, 60 tablet bulk pack | RXCAPS-BULKB | ✓ | | ✓ | |
| | green, over 25lbs, 60 tablet bulk pack | RXCAPS-BULKG | ✓ | | ✓ | |
| Captopril Tablets | 12.5mg, 100 tablets | RXCAP12.5-100 | | ✓ | | |
| | 25mg, 100 tablets | RXCAP25-100 | | ✓ | | |
| | 50mg, 100 tablets | RXCAP50-100 | | ✓ | | |
| | 25mg, 1000 tablets | RXCAP25-1000 | | ✓ | | |



No returns on pharmaceuticals • Prices change frequently please call for current price • Shipping charges for refrigerated items are a flat charge based on your shipping zone. Customer accepts full responsibility for condition of products upon receipt. * Indicates Refrigerated Shipping • Pictures are for graphic purposes only, actual product may be different.

| Product | Size/Details | Product Code | Vet Label | RX | Brand | DEA |
|---|--|-----------------|-----------|----|-------|-----|
| Carbocaine | 2%, 50ml | RXCARBOCAINE | | ✓ | ✓ | |
| Carbon Dioxide Absorbent | 3lb bag | RXSODA-SORB | | | | |
| Cat Lax | 2oz | RXCAT-LAX | ✓ | | ✓ | |
| Catosal | 100ml | RXCATOSAL-100 | ✓ | ✓ | ✓ | |
| | 250ml | RXCATOSAL-250 | ✓ | ✓ | ✓ | |
| Cefa-Drops | 50mg/ml, 15ml | RXCEFADRO-15 | ✓ | ✓ | ✓ | |
| | 50mg/ml, 50ml | RXCEFADRO-50 | ✓ | ✓ | ✓ | |
| Cefadroxil | 500mg, 100 capsules | RXCEF500-100 | | ✓ | | |
| Cefazolin Injection | 500mg vial | RXCEF500-V | | ✓ | | |
| | 1 gram vial | RXCEF1GM-V | | ✓ | | |
| | 10 gram vial | RXCEF10GM-V | | ✓ | | |
| Cefpodoxime | 200mg, 100 film coated tablets | RXCEFPD200-100 | | ✓ | | |
| Ceftazidime (Fortaz) Powder for Injection | 1 gram | RXCEFTAZIDIME | | ✓ | | |
| Ceftriaxone Injection | 500mg | RXROCEPHIN500 | | ✓ | | |
| | 1gram | RXROCEPHIN | | ✓ | | |
| Celestone Soluspan | 6mg/ml, 5ml | RXCELESTONE | | ✓ | ✓ | |
| Centrine Injection | 5mg/ml, 10ml | RXCEN-INJ | ✓ | ✓ | ✓ | |
| Centrine Tablets | 0.2mg, 100 tablets | RXCENTRINE2-100 | ✓ | ✓ | ✓ | |
| Cephalexin Capsules | 250mg, 100 capsules | RXCEP250-100 | | ✓ | | |
| | 250mg, 500 capsules | RXCEP250-500 | | ✓ | | |
| | 500mg, 100 capsules | RXCEP500-100 | | ✓ | | |
| | 500mg, 500 capsules | RXCEP500-500 | | ✓ | | |
| |  | | | | ✓ | |
| Cephalexin Oral Suspension | 125mg/5ml, 200ml | RXCES125-200 | | ✓ | | |
| | 250mg/5ml, 100ml | RXCES250-100 | | ✓ | | |
| | 250mg/5ml, 200ml | RXCES250-200 | | ✓ | | |
| Cephalexin Tablets | 250mg, 100 tablets | RXCEP250-100T | | ✓ | | |
| | 500mg, 100 tablets | RXCEP500-100T | | ✓ | | |
| Cerenia | 20 ml injection | RXCERENIA-INJ | ✓ | ✓ | ✓ | |
| Cestex | 12.5mg, 50 tablets | RXCESTEX12-50 | ✓ | ✓ | ✓ | |
| | 25mg, 50 tablets | RXCESTEX25-50 | ✓ | ✓ | ✓ | |
| | 50mg, 25 tablets | RXCESTEX50-25 | ✓ | ✓ | ✓ | |
| | 100mg, 25 tablets | RXCESTEX100-25 | ✓ | ✓ | ✓ | |
| CET 0.12% Chlorhexidine Rinse | 8oz | RXCET-RINSE | ✓ | | | |
| CET Fingerbrush with Paste | 1 brush, 12gm paste | RXCET-12 | ✓ | | ✓ | |
| CET Oral Hygiene Kit | 1 toothbrush, 1 finger brush, toothpaste | RXCET-KIT | ✓ | | ✓ | |
| CET Toothpaste | | RXCET-PASTE | ✓ | | ✓ | |
| Cetacaine Hospital Gel | 5ml tube | RXCETA-GEL | | ✓ | ✓ | |
| Cetacaine Liquid | 30gm bottle | RXCETA-LIQ | | ✓ | ✓ | |
| Cetacaine Spray & Cannula | 56gm bottle | RXCETA-SPRAY | | ✓ | ✓ | |
| Cetirizine Syrup | 5mg/ml, 4 ounces | RXCETIRIZ-LIQ | | | | |
| Cetirizine Tablets | 10mg, 90 tablets | RXCETIRIZINE | | | | |
| Chlor-A Flush | 4oz | RXLIDO-4 | ✓ | | | |
| Chloraderm Shampoo | 1%, 8oz | RXCHLORADERM | ✓ | | | |
| Chloramphenicol (Viceton) Tablets | 250mg, 500 tablets | RXCHLORA250-500 | ✓ | ✓ | | |
| | 500mg, 500 tablets | RXCHLORA500-500 | ✓ | ✓ | | |

No returns on pharmaceuticals • Prices change frequently please call for current price • Shipping charges for refrigerated items are a flat charge based on your shipping zone. Customer accepts full responsibility for condition of products upon receipt. ❄️ indicates Refrigerated Shipping • Pictures are for graphic purposes only, actual product may be different.



| Product | Size/Details | Product Code | Vet Label | RX | Brand | DEA |
|--|---------------------------|----------------|-----------|----|-------|-----|
| Chlorhexidine and Zinc Oral Spray | 8oz bottle | RXCHZN-8 | ✓ | | | |
| Chlorhexidine Scrub/Solution | 4%, 16oz | RXCHLOR4-16 | | | | |
| | 4%, gallon | RXCHLOR4-GAL | | | | |
| Chlorhexidine Solution | 2%, gallon | RXCHLOR2-GAL | ✓ | | | |
| Chlorpheniramine Tablets | 4mg, 100 tablets | RXCHLOM4-100 | | | | |
| | 4mg, 1000 tablets | RXCHLOM4-1000 | | | | |
| Chlorpromazine Tablets | 10mg, 100 tablets | RXCHL10-100 | | ✓ | | |
| | 100mg, 100 tablets | RXCHLOR100-100 | | ✓ | | |
| Cholodin Pet Vitamins | 50 tablets | RXCHOLOD-50 | ✓ | | ✓ | |
| Chondrogen EQ | 10 dose tube | RXCHON-EQ-10 | ✓ | | ✓ | |
| | 50 dose powder, 25oz | RXCHON-EQ-25 | ✓ | | ✓ | |
| | 150 dose powder, 75oz | RXCHON-EQ-75 | ✓ | | ✓ | |
| Chorion (HCG) * | 10,000 IU, 10ml | RXHCG-10 | ✓ | ✓ | | |
| Cimetidine Oral Liquid | 300mg/5ml, 8oz | RXCIM300-8OZ | | ✓ | | |
| Cimetidine Tablets | 200mg, 30 tablets | RXCIM200-30 | | ✓ | | |
| | 400mg, 100tablets | RXCIM400-100 | | ✓ | | |
| | 800mg, 100 tablets | RXCIM800-100 | | ✓ | | |
| Ciprofloxacin Ophthalmic Solution | 0.3%, 2.5ml | RXCIPRO-OPH2.5 | | ✓ | | |
| | 0.3%, 5ml | RXCIPRO-OPH5 | | ✓ | | |
| Ciprofloxacin Tablets | 250mg, 100 tablets | RXCIPRO-250 | | ✓ | | |
| | 500mg, 100 tablets | RXCIPRO-500 | | ✓ | | |
| | 750mg, 50 tablets | RXCIPRO-750-50 | | ✓ | | |
| Citalopram | 20mg, 500 tablets | RXCITALOPRAM | | ✓ | | |
| Claforan Injection | 1 gram | RXCLAF-1GM | | ✓ | ✓ | |
| Clavamox Drops | 62.5mg/ml, 15ml | RXCLAV-DR15 | ✓ | ✓ | ✓ | |
| Clavamox Tablets | 62.5mg, 210 tablets | RXCLAV62-210 | ✓ | ✓ | ✓ | |
| | 125mg, 210 tablets | RXCLAV125210 | ✓ | ✓ | ✓ | |
| | 250mg, 210 tablets | RXCLAV250210 | ✓ | ✓ | ✓ | |
| | 375mg, 210 tablets | RXCLAV375-210 | ✓ | ✓ | ✓ | |
| Clean and Fresh Oral Spray | 0.1%, 8oz | RXCLEAN-8 | ✓ | | | |
| Clemastine Tablets | 1.34mg, 100 tablets | RXCLEMAST134 | | ✓ | | |
| | 2.68mg, 100 tablets | RXCLEMAST268 | | ✓ | | |
| Clindamycin HCl Capsules | 150mg, 100 capsules | RXCLI150-100 | | ✓ | | |
| | 300mg, 100 capsules | RXCLI300-100 | | ✓ | | |
| Clindamycin Oral Drops | 25mg/ml, 20ml | RXCLIND-20 | ✓ | ✓ | | |
| Clindamycin Phosphate Injection | 150mg/ml, 4ml, pack of 25 | RXCLIND-INJ | | ✓ | | |
| Clindamycin Phosphate Topical Solution | 1%, 60ml | RXCLINTOP1-60 | | ✓ | | |
| Clobetasol Propionate Cream | 0.05%, 30gm | RXCLOB-30 | | ✓ | | |
| Clomipramine HCl Capsules | 25mg, 100 capsules | RXCLOM25-100 | | ✓ | | |
| | 50mg, 100 capsules | RXCLOM50-100 | | ✓ | | |
| | 75mg, 100 capsules | RXCLOM75-100 | | ✓ | | |
| Clonazepam (CIV) Tablets | 0.5mg, 100 tablets | RXCLONAZ.5-100 | | ✓ | | CIV |
| Clonidine Tablets | 0.1mg, 100 tablets | RXCLONDINE0.1 | | ✓ | | |
| Clotrimazole Topical Solution | 1%, 30ml | RXCLOT-LIQ | | ✓ | | |
| Clotrimazole with Betamethasone Cream | 15gm | RXCLOT-BET15 | | ✓ | | |

No returns on pharmaceuticals • Prices change frequently please call for current price • Shipping charges for refrigerated items are a flat charge based on your shipping zone. Customer accepts full responsibility for condition of products upon receipt. * Indicates Refrigerated Shipping • Pictures are for graphic purposes only, actual product may be different.

| Product | Size/Details | Product Code | Vet Label | RX | Brand | DEA |
|------------------------------------|---|-----------------|-----------|----|-------|-----|
| Con Form Aid Granules | 5 lb. | RXCONFORM5 | ✓ | | ✓ | |
| Conquer Equine | Apple Flavor, 6 Dose Tube | RXCONQ-EQ-6 | ✓ | | ✓ | |
| Conquer Equine Powder | Apple Flavor, 25oz, 50 servings | RXCONQ-EQ-25 | ✓ | | ✓ | |
| Conquer K-9 | Beef Flavor, 30 Dose Tube | RXCONQ-K9-30 | ✓ | | ✓ | |
| Contender Advance Hoof Formula | 32oz | RXCONHOOF-32 | ✓ | | ✓ | |
| | Gallon | RXCONHOO-128 | ✓ | | ✓ | |
| Corium-20 | 8oz | RXCORIUM-OTIC | ✓ | ✓ | ✓ | |
| Corta RX Solution | gallon | RXCORTARX-GAL | ✓ | ✓ | ✓ | |
| Corti-Derm Spray | 4 oz. | RXCORTI-DERM4 | ✓ | | | |
| Corti-Derm Spray 1 oz | 1 oz | RXCORTI-DERM1 | ✓ | | | |
| Cortrosyn | 250mcg, 2ml vial | RXACTH-0.25 | ✓ | ✓ | ✓ | |
| Cosequin Capsules | Regular Strength, 90 capsules | RXCOS-RS90 | ✓ | | ✓ | |
| | Double Strength, 120 capsules | RXCOSDS-120 | ✓ | | ✓ | |
| Cosequin Chewable Tablets | Double Strength, 120 tablets | RXCOSDS-CHEW120 | ✓ | | ✓ | |
| | Double Strength, 250 tablets | RXCOSDS-CHEW250 | ✓ | | ✓ | |
| Cosequin Equine Powder | 1400gram jar | RXCOS-EQ1400 | ✓ | | ✓ | |
| Cosequin For Cats | Tuna Flavor, 80 capsules/box | RXCOSFEL-80 | ✓ | | ✓ | |
| Cough Tablets for Dogs | Guaifenesin/dextromethorphan 1000 tablets | RXCOUGH-TAB | ✓ | | | |
| Crystal Clear Calcium Gel | 300ml | RXCCC-GEL | ✓ | | | |
| Cut-Heal Wound Spray | 4oz | RXCUT-SPRAY | ✓ | | | |
| Cut-Pad Dog Pad Protector | 4oz | RXCUT-PAD | ✓ | | | |
| Cyclobenzaprine Tablets | 10mg, 100 tablets | RXCYCLOBENZ | | ✓ | | |
| Cyclopentolate Ophthalmic Solution | 1%, 15ml | RXCYCLOGYL-15 | | ✓ | | |
| Cyclophosphamide Injection * | 500mg, 50ml | RXCYCLOPHOS-500 | | ✓ | | |
| Cyclosporine (modified) Capsules | 25mg, 30 capsules | RXCYCLO25-30 | | ✓ | | |
| | 50mg, 30 capsules | RXCYCLO50-30 | | ✓ | | |
| | 100mg, 30 capsules | RXCYCLO100-30 | | ✓ | | |
| Cyproheptadine Tablets | 4mg, 100 tablets | RXCYP4-100 | | ✓ | | |
| | 4mg, 1000 tablets | RXCYP4-1000 | | ✓ | | |
| Cystorelin * | 5 dose, 10ml | RXCSTORELIN | ✓ | ✓ | ✓ | |
| DAP | Collar, small 45cm | RXDAP-COLS | ✓ | | ✓ | |
| | spray, 60ml | RXDAP-SPRAY | ✓ | | ✓ | |
| | Collar, large 70cm | RXDAP-COLL | ✓ | | ✓ | |
| | Diffuser and Refill, 48ml | RXDAP-DIF | ✓ | | ✓ | |
| Dasuquin | large, 84 capsules | RXDASUQUIN-LG | ✓ | | ✓ | |
| Dehydrated Alcohol | 1ml ampule | RXALCOHOL | | ✓ | | |
| Delta Albaplex 3x Tablets | 180mg, 250 tablets | RXDELTA-ALBA3X | ✓ | ✓ | ✓ | |
| Delta Albaplex Tablets | 60mg, 500 tablets | RXDELTA-ALBA | ✓ | ✓ | ✓ | |
| Denamarin | for small dogs and cats, 90mg, 30 tablets | RXDENAMARIN-SM | ✓ | | ✓ | |
| | for medium dogs, 225mg, 30 tablets | RXDENAMARIN-M | ✓ | | ✓ | |
| | for Large Dogs | RXDENAMARIN-L | ✓ | | ✓ | |



No returns on pharmaceuticals • Prices change frequently please call for current price • Shipping charges for refrigerated items are a flat charge based on your shipping zone. Customer accepts full responsibility for condition of products upon receipt. * Indicates Refrigerated Shipping • Pictures are for graphic purposes only, actual product may be different.



| Product | Size/Details | Product Code | Vet Label | RX | Brand | DEA |
|--|--------------------------|-----------------|-----------|----|-------|-----|
| Denosyl Tablets  | 90mg, 30 tablets/box | RXDENO-90 | ✓ | | ✓ | |
| | 225mg, 30 tablets/box | RXDENO-225 | ✓ | | ✓ | |
| | 425mg, 30 tablets | RXDENO-425 | ✓ | | ✓ | |
| Dentacetic Dentees Chews | 10oz pack | RXDEN-CHEW | ✓ | | ✓ | |
| Dentacetic Dentees Stars | 4oz pack | RXDEN-STARS | ✓ | | ✓ | |
| Dentacetic Gel | 2oz | RXDEN-GEL | ✓ | | ✓ | |
| Dentacetic Wipes | 25 wipes/pack | RXDEN-WIPES | ✓ | | ✓ | |
| Depo Medrol | 20mg/ml, 5ml | RXDEPO20-5 | | ✓ | ✓ | |
| | 40mg/ml, 5ml | RXDEPO40-5 | | ✓ | ✓ | |
| | 40mg/ml, 10ml | RXDEPO40-10 | | ✓ | ✓ | |
| | 80mg/ml, 5ml | RXDEPO80-5 | | ✓ | ✓ | |
| Depo Medrol (Veterinary Label) | 20mg/ml, 20ml | RXDEPO20-20VE | ✓ | ✓ | ✓ | |
| | 40mg/ml, 5ml | RXDEPO40-5VE | ✓ | ✓ | ✓ | |
| Depoestradiol | 5mg/ml, 5ml | RXDEPOESTRADIOL | | ✓ | ✓ | |
| Deramaxx Tablets  | 25mg, 30 tablets | RXDERA25-30 | ✓ | ✓ | ✓ | |
| | 25mg, 90 tablets | RXDERA25-90 | ✓ | ✓ | ✓ | |
| | 75mg, 30 tablets | RXDERA75-30 | ✓ | ✓ | ✓ | |
| | 75mg, 90 tablets | RXDERA75-90 | ✓ | ✓ | ✓ | |
| | 100mg, 30 tablets | RXDERA100-30 | ✓ | ✓ | ✓ | |
| | 100mg, 90 tablets | RXDERA100-90 | ✓ | ✓ | ✓ | |
| Derma Cloth | 7oz, 8 wipes/pk | RXDERM-CL-8 | ✓ | | ✓ | |
| Derma-Form | 8oz liquid | RXDERMAFORM8 | ✓ | | | |
| | 350gm granules | RXDERMAFORM350 | ✓ | | | |
| Derma-Vet Ointment | 7.5ml | RXDERMAVET | ✓ | ✓ | ✓ | |
| | 15ml | RXDERMAVET15 | ✓ | ✓ | ✓ | |
| | 30ml | RXDERMAVET30 | ✓ | ✓ | ✓ | |
| | 240ml | RXDERMAVET240 | ✓ | ✓ | ✓ | |
| Dermabenss Shampoo | 12oz | RXDERBEN-8 | ✓ | | ✓ | |
| Dermal Soothe Creme Rinse | 12oz | RXDERM-SOOTHE | ✓ | | ✓ | |
| Dermallay Oatmeal Conditioner | 8oz | RXDERM-COND | ✓ | | ✓ | |
| | gallon | RXDERM-CONDGAL | ✓ | | ✓ | |
| Dermallay Oatmeal Shampoo | gallon | RXDERM-OSHAM-GA | ✓ | | ✓ | |
| Dermallay Shampoo | 12oz | RXDERM-SHAM | ✓ | | ✓ | |
| Dermalyte Shampoo | 12oz | RXDERMHY-SH | ✓ | | ✓ | |
| Dermatonin (melatonin) Implant  | 8mg for dogs under 25lbs | RXDERMATON8 | ✓ | ✓ | ✓ | |
| | 12mg for dogs 25-50lbs | RXDERMATON12 | ✓ | ✓ | ✓ | |
| | 18mg for dogs over 50lbs | RXDERMATON18 | ✓ | ✓ | ✓ | |
| Dermatophyte Test Medium | 10 cultures/box | RXDTM-CULTURE | | | | |
| Dexamethasone Injection | 2mg/ml, 100ml | RXDEX2-100 | ✓ | ✓ | | |
| | 10mg/ml, 10ml | RXDEX10-10 | | ✓ | | |
| Dexamethasone Ophthalmic Suspension | 0.1%, 5ml | RXDEXOPHTH-5ML | | ✓ | | |
| Dexamethasone S.P. Injection | 4mg/ml, 5ml | RXDEX4-5 | | ✓ | | |
| | 4mg/ml, 30ml | RXDEX4-30 | | ✓ | | |
| | 4mg/ml, 100ml | RXDEX4-100IN | ✓ | ✓ | | |

No returns on pharmaceuticals • Prices change frequently please call for current price • Shipping charges for refrigerated items are a flat charge based on your shipping zone. Customer accepts full responsibility for condition of products upon receipt. ❄ Indicates Refrigerated Shipping • Pictures are for graphic purposes only, actual product may be different.

| Product | Size/Details | Product Code | Vet Label | RX | Brand | DEA |
|--|--|-----------------|-----------|----|-------|-----|
| Dexamethasone Tablets | 0.5mg, 100 tablets | RXDEX0.5-100 | | ✓ | | |
| | 0.75mg, 100 tablets | RXDEX.75-100 | | ✓ | | |
| | 4mg, 100 tablets | RXDEX4-100 | | ✓ | | |
| Dexdomitor |  0.5mg/ml, 10ml | RXDEXDOMITOR | ✓ | ✓ | ✓ | |
| Dextrose Injection | 50%, 50ml | RXDEX50-INJ | | ✓ | | |
| | 50%, 500ml glass bottle | RXDEX50-500 | | ✓ | | |
| Diazepam (CIV) Tablets | 10mg, 100 tablets | RXDIAZ10-100 | | ✓ | | CIV |
| Diazepam (CIV) Injection | 5mg/ml, 10ml vial, 10 pack | RXDIAZEP10X10 | | ✓ | | CIV |
| Diclofenac Sodium Tablets | 75mg, 100 tablets | RXDICLOF-75 | | ✓ | | |
| Dicural Tablets | 11.4mg, 100 tablets | RXDICU11-100 | ✓ | ✓ | ✓ | |
| Difil-Test Stain | 15ml bottle | RXDIF-STAIN | ✓ | | | |
| Digoxin Elixer | 0.05mg/ml, 60ml | RXDIGEL-60 | | ✓ | | |
| Digoxin Injection | 0.25mg/ml, 2ml | RXDIG-2MLINJ | | ✓ | | |
| Digoxin Tablets | 0.125mg, 100 tablets | RXDIG125-100 | | ✓ | | |
| | 0.25mg, 100 tablets | RXDIG.25-100 | | ✓ | | |
| Diltiazem Tablets | 30mg, 500 tablets | RXDILT30-500 | | ✓ | | |
| Diphenhydramine Capsules |  25mg, 100 capsules | RXBENA25-100 | | | | |
| | 25mg, 1000 capsules | RXBENA25-1000 | | | | |
| | 50mg, 100 capsules | RXBENA50-100 | | | | |
| | 50mg, 1000 capsules | RXBENA50-1000 | | | | |
| Diphenhydramine Cream | 30gm | RXBENA-CREAM | | | | |
| Diphenhydramine Elixer | 12.5mg/5ml, 4 oz | RXBENA-ELIX4 | | | | |
| | 12.5mg/5ml, 16 oz | RXBENA-ELIX16 | | | | |
| Diphenhydramine Injection | 50mg/ml, 1ml | RXBEN-50INJ | | ✓ | | |
| | 50mg/ml, 10ml | RXBEN50-10INJ | | ✓ | | |
| DL Methionine Tablets | 200mg, 1000 tablets | RXDLM200-K | ✓ | ✓ | ✓ | |
| | 500mg, 1000 tablets | RXDLM500-K | ✓ | ✓ | ✓ | |
| DMSO (Liquid) | 1 pint | RXDMSO-PINT | ✓ | | | |
| DMSO Gel | 1lb | RXDMSO-1LB | ✓ | | | |
| Dobutamine HCl | 12.5mg/ml, 20ml | RXDOBUTAMINE | | ✓ | | |
| Docu-Soft Pet Enema | 12ml | RXPET-ENEMA | ✓ | | | |
| Docusate Sodium (DSS) | 100mg, 100 tablets | RXDSS100-100 | | | | |
| Dolorex (CIV) Injection | 50ml | RXDLOREX-50 | ✓ | ✓ | ✓ | CIV |
| Dopamine Injection | 80mg/5ml, 5ml | RXDOPAMINE-V | | ✓ | | |
| Dormosedan | 10mg/ml, 5ml | RXDORM-5 | ✓ | ✓ | ✓ | |
| | 10mg/ml, 20ml | RXDORM-20 | ✓ | ✓ | ✓ | |
| Dorzolamide/Timolol (generic Cosopt) Ophthalmic Solution | 22.3/6.8, 10ml | RXCOSOPT-10ML | | ✓ | | |
| Doxycycline Capsules |  100mg, 50 capsules | RXDIX100-50C | | ✓ | | |
| | 100mg, 500 capsules | RXDIX100-500C | | ✓ | | |
| Doxycycline Tablets | 100mg, 50 tablets | RXDIX100-50T | | ✓ | | |
| | 100mg, 500 tablets | RXDIX100-500T | | ✓ | | |
| Droncit Canine Tablets | 34mg, 50 tablets | RXDRONCIT34-50 | ✓ | ✓ | ✓ | |
| | 34mg, 150 tablets | RXDRONCIT34-150 | ✓ | ✓ | ✓ | |
| Droncit Feline Tablets | 23mg, 50 tablets | RXDRONCIT23-50 | ✓ | ✓ | ✓ | |

No returns on pharmaceuticals • Prices change frequently please call for current price • Shipping charges for refrigerated items are a flat charge based on your shipping zone. Customer accepts full responsibility for condition of products upon receipt.  indicates Refrigerated Shipping • Pictures are for graphic purposes only, actual product may be different.



| Product | Size/Details | Product Code | Vet Label | RX | Brand | DEA |
|--|--------------------------------------|-----------------|-----------|----|-------|-----|
| Droncit Injection | 56.8mg/ml, 10ml | RXDRONCIT-INJ10 | ✓ | ✓ | ✓ | |
| Drontal For Cats | 50 tablets | RXDRON-FEL | ✓ | ✓ | ✓ | |
| Drontal Plus | 22.7mg, small, 50 tablets | RXDRON-K9S | ✓ | ✓ | ✓ | |
| | 68mg, medium, 50 tablets | RXDRON-K9M | ✓ | ✓ | ✓ | |
| | 136mg, large, 30 tablets | RXDRON-K9G | ✓ | ✓ | ✓ | |
| Durvet Bloat Treatment | 12oz | RXBLOAT-12 | ✓ | | | |
| E-SE (Vitamin E & Selenium Injection) | 100ml | RXVITSELIJ | ✓ | ✓ | ✓ | |
| Ear Cleaner | 4oz bottle | RXOTIC-JC | ✓ | | | |
| Ear Mite Killer | 6oz | RXEARMITE-6 | ✓ | | | |
| Eicosaderm | EPA 360mg/DHA 240mg, 8oz | RXEICO-8 | ✓ | | ✓ | |
| Electro-Flex Oral Electrolytes | 34gm paste | RXELEC-34 | ✓ | | ✓ | |
| EMLA Cream | lidocaine/prilocaine 2.5%/2.5%, 30gm | RXEMLA-CR | | ✓ | | |
| Enalapril Maleate | 2.5mg, 100 tablets | RXENA2.5-100 | | ✓ | | |
| | 2.5mg, 1000 tablets | RXENA2.5-1000 | | ✓ | | |
| | 5mg, 100 tablets | RXENA5-100 | | ✓ | | |
| | 5mg, 1000 tablets | RXENA5-1000 | | ✓ | | |
| | 10mg, 100 tablets | RXENA10-100 | | ✓ | | |
| | 10mg, 1000 tablets | RXENA10-1000 | | ✓ | | |
| | 20mg, 100 tablets | RXENA20-100 | | ✓ | | |
| | 20mg, 1000 tablets | RXENA20-1000 | | ✓ | | |
| Enduracide Dip II | 8oz | RXENDUDIP-8 | ✓ | | ✓ | |
| | 1 gallon | RXENDUDIP-G | ✓ | | ✓ | |
| Enisyl-F | 100ml pump bottle | RXLYSINE-100ML | ✓ | | ✓ | |
| EP-1 3X Probiotic Paste | 30gm, apple flavored | RXEP1-3X | ✓ | | | |
| EP2 Plus Electrolyte Vitamin Paste | 30gm, apple flavored | RXEP2-PLUS | ✓ | ✓ | | |
| Epakitin | 50gm | RXEPAKITIN50 | ✓ | ✓ | ✓ | |
| | 150gm | RXEPAKITIN150 | ✓ | ✓ | ✓ | |
| | 300gm | RXEPAKITIN300 | ✓ | ✓ | ✓ | |
| Ephedrine Sulfate Injection | 50mg/ml, 25x1ml/pk | RXEPHED25X1 | | ✓ | | |
| Epi-Otic Cleanser | 4oz | RXEPI-OTIC | ✓ | | ✓ | |
| | 8oz | RXEPI-OTIC8 | ✓ | | ✓ | |
| | 16oz | RXEPI-OTIC16 | ✓ | | ✓ | |
| Epi-Soothe | shampoo 8oz | RXEPISOOTHE8 | ✓ | | ✓ | |
| Epi-Soothe Oatmeal Shampoo | gallon | RXEPISOOTHE-G | ✓ | | ✓ | |
| Epinephrine HCl | 1mg/ml, 1ml ampule | RXEPI1-INJ | | ✓ | | |
| | 1mg/ml, 30ml | RXEPI-30 | | ✓ | | |
| Epizyme Powder | 4oz | RXZYME-4OZ | ✓ | ✓ | ✓ | |
| | 8oz | RXZYME-8OZ | ✓ | ✓ | ✓ | |
| | 12oz | RXZYME-12OZ | ✓ | ✓ | ✓ | |
| Epogen * | 2000 units, 1ml | RXEPOGEN | | ✓ | | |
| EQ-Stim Equine Immunostimulant | 5ml | RXEQSTIM-5 | ✓ | ✓ | ✓ | |
| | 50ml | RXEQSTIM-50 | ✓ | ✓ | ✓ | |
| Equi-Aid CW | 10lb | RXEQU-AID-CW | ✓ | | ✓ | |
| Equi-Aid Psyllium | 20lb | RXEQUAID-20 | ✓ | | ✓ | |
| Equi-Mintic SPR Paste | 23.6gm | RXEQUI-MINTIC | ✓ | | ✓ | |
| Equine Bluelite | 6lb | RXEQBLUE-6 | ✓ | | ✓ | |

| Product | Size/Details | Product Code | Vet Label | RX | Brand | DEA |
|-----------------------------------|--|-----------------|-----------|----|-------|-----|
| Equine One Gel | 30gm | RXEONE-30 | ✓ | | ✓ | |
| Equipoise (CIII) Injection | 50mg/ml, 50ml | RXEQUIPOI-50 | ✓ | ✓ | ✓ | CII |
| Eqvalan Paste | 1.87%, Single Dose | RXEQVALAN | ✓ | | ✓ | |
| Erythromycin Ophthalmic Ointment | 0.5%, 3.5gm tube | RXERYOPH-3.5 | | ✓ | | |
| Erythromycin Tablets | 500mg, 100 tablets | RXERY500-100 | | ✓ | | |
| Erythromycin Topical Solution | 2%, 60ml | RXERYTOP2-60 | | ✓ | | |
| Esbilac Puppy Milk Replacer |  8oz liquid | RXESBILAC-8 | ✓ | | ✓ | |
| | 11oz liquid | RXESBILAC-12.5 | ✓ | | ✓ | |
| | 12oz powder | RXESBILAC-12 | ✓ | | ✓ | |
| Esmolol Injection | 1mg, 10 x 1ml/bx | RXESMOLOL | ✓ | | ✓ | |
| Estrumate 10 dose vial | 10 dose vial | RXESTRUMATE-100 | ✓ | ✓ | ✓ | |
| Etodolac | 300mg, 100 capsules | RXETO300-100 | | ✓ | | |
| | 400mg, 100 tablets | RXETO400-100 | | ✓ | | |
| Euthanasia III (CIII) Solution | 100ml | RXEUTH-III | ✓ | ✓ | | CII |
| Euthasol (CIII) Solution | 100ml | RXEUTHASOL | ✓ | ✓ | ✓ | CII |
| Excede | 100mg/ml, 100ml, swine | RXEXCEED | ✓ | ✓ | ✓ | |
| Excenel (Ceftiofur HCl) Injection | 50mg/ml, 100ml | RXEXCENEL | ✓ | ✓ | ✓ | |
| Exodus (43.9% Pyrantel) Paste | Multi-dose syringe for horses (47.2g) | RXEXODUS-MD | ✓ | | ✓ | |
| | each syringe treats a 1200lb horse | RXEXODUS | ✓ | | ✓ | |
| Eye Wash | 4oz | RXEYE-4 | | | | |
| Famotidine Injection * | 10mg/ml, 20ml | RXFAMP10-20 | | ✓ | | |
| Famotidine Tablets | 20mg, 100 tablets | RXFAMP20-100 | | ✓ | | |
| | 20mg, 1000 tablets | RXFAMP20-1000 | | ✓ | | |
| | 40mg, 100 tablets | RXFAMP40-100 | | ✓ | | |
| |  | | | | | |
| Fatal-Plus Solution (CII) | 390mg/ml, 250ml | RXFATAL-PLUS | ✓ | ✓ | ✓ | CII |
| Feliway | diffuser and refill, 48ml | RXFELWAY-DIF | ✓ | | ✓ | |
| | refill, 48ml | RXFELWAY-REF | ✓ | | ✓ | |
| | spray, 75ml | RXFELWAY-SP | ✓ | | ✓ | |
| Felovite II | 2.5oz | RXFELOWITE | ✓ | | | |
| Fentanyl (CII) Transdermal Patch | 12mcg/hr, 5/box | RXFENTANYL12.5 | | ✓ | | CII |
| | 25mcg/hr, 5/box | RXFENTANYL25 | | ✓ | | CII |
| | 50mcg/hr, 5/box | RXFENTANYL50 | | ✓ | | CII |
| | 75mcg/hr, 5/box | RXFENTANYL75 | | ✓ | | CII |
| | 100mcg/hr, 5/box | RXFENTANYL100 | | ✓ | | CII |
| Fentanyl Citrate Injection (CII) | 0.05mg/ml, 5ml vial, 25 vials/pack | RXFENTANYL-INJ | | ✓ | | CII |
| | 0.05mg/ml, 50ml vial, 25 vials/pack | RXFENTANY-INJ50 | | ✓ | | CII |
| Flea and Tick Collar | 22 inch | RXFLTI-COLR | ✓ | | ✓ | |
| Flourescein Stain Strips | 100/box | RXFUL-GLO | | | | |
| Fluconazole Tablets | 100mg, 100 tablets | RXFLU100-100 | | ✓ | | |
| | 200mg, 100 tablets | RXFLU200-100 | | ✓ | | |
| Fludrocortisone Acetate Tablets | 0.1mg, 100 tablets | RXFLORINEF | | ✓ | | |
| Flunixin Meglumine | 50mg/ml, 100ml | RXFLUNDX-100 | ✓ | ✓ | | |
| | 50mg/ml, 250ml | RXFLUNDX-250 | ✓ | ✓ | | |
| Fluocinonide Ointment | 0.05% 60 gram | RXFLUOC-60G | | ✓ | | |

No returns on pharmaceuticals • Prices change frequently please call for current price • Shipping charges for refrigerated items are a flat charge based on your shipping zone. Customer accepts full responsibility for condition of products upon receipt. * Indicates Refrigerated Shipping • Pictures are for graphic purposes only, actual product may be different.

| Product | Size/Details | Product Code | Vet Label | RX | Brand | DEA |
|---|----------------------------------|-----------------|-----------|----|-------|-----|
| Fluocinonide Solution | 0.05%, 60ml | RXFLUOC-60ML | | ✓ | | |
| Fluoxetine Capsules | 10mg, 100 capsules | RXFLUOX10-100 | | ✓ | | |
| | 20mg, 100 capsules | RXFLUOX20-100 | | ✓ | | |
| Fluoxetine HCl Oral Solution | 20mg/5ml, 120ml | RXFLUOX-LIQ | | ✓ | | |
| Fluoxetine Tablets | 10mg, 30 tablets | RXFLUOX10-30 | | ✓ | | |
| Flurazepam (CIV) Tablets | 15mg, 100 tablets | RXFLURAZEPAM | | ✓ | | CIV |
| Flurbiprofen Sodium Ophthalmic Solution | 0.03%, 2.5ml | RXFLURB-OPH | | ✓ | | |
| Fly Rid Plus | 1 gallon | RXFLY-RIDPLUS | ✓ | | | |
| Forbid | 12/pack | RXFORBID-12 | ✓ | | ✓ | |
|  Frontline Plus | up to 22 lbs, 3 month | RXFRON-22-3 | ✓ | | ✓ | |
| | up to 22 lbs, 6 month | RXFRON-22-6 | ✓ | | ✓ | |
| | 23-44 lbs, 3 month | RXFRON-44-3 | ✓ | | ✓ | |
| | 23-44 lbs, 6 month | RXFRON-44-6 | ✓ | | ✓ | |
| | 45-88 lbs, 3 month | RXFRON-88-3 | ✓ | | ✓ | |
| | 45-88 lbs, 6 month | RXFRON-88-6 | ✓ | | ✓ | |
| | 89-132 lbs, 3 month | RXFRON-132-3 | ✓ | | ✓ | |
| | 89-132 lbs, 6 month | RXFRON-132-6 | ✓ | | ✓ | |
| | Feline, 3 month | RXFRON-FEL-3 | ✓ | | ✓ | |
| | Feline, 6 month | RXFRON-FEL-6 | ✓ | | ✓ | |
| Frontline Spray | 250ml | RXFRON-SPRAY250 | ✓ | | ✓ | |
| | 500ml | RXFRON-SPRAY | ✓ | | ✓ | |
| Fungicide, Topical | 16 oz | RXFUNG-CIDE | ✓ | | | |
| Furosemide Injection | 10mg/ml, 25 x 2ml SDV | RXFUR10-2X25 | | ✓ | | |
| | 10mg/ml, 2ml SDV | RXFUR10-2ML | | ✓ | | |
| | 50mg/ml, 50ml | RXFUR50-50 | ✓ | ✓ | | |
| Furosemide Oral Solution | 10mg/ml, 60ml | RXFUR-60ML | | ✓ | | |
| | 10mg/ml, 120ml | RXFUR-120ML | | ✓ | | |
|  Furosemide Tablets | 12.5mg, 500 tablets | RXLAS12.5-500 | ✓ | ✓ | ✓ | |
| | 20mg, 100 tablets | RXFURO20-100 | | ✓ | | |
| | 20mg, 1000 tablets | RXFURO20-K | | ✓ | | |
| | 40mg, 100 tablets | RXFURO40-100 | | ✓ | | |
| | 40mg, 1000 tablets | RXFUR40-K | | ✓ | | |
| | 50mg, 500 tablets | RXLAS50-500 | ✓ | ✓ | ✓ | |
| Gabapentin Capsules | 100mg, 100 capsules | RXGABA100-100 | | ✓ | | |
| | 400mg, 100 capsules | RXGABA400-100 | | ✓ | | |
| | 300mg, 100 capsules | RXGABA300-100 | | ✓ | | |
| | 800mg, 100 capsules | RXGABA800-100 | | ✓ | | |
| Gastrogard | 14 syringe pack | RXGASTRO-14 | ✓ | ✓ | ✓ | |
| Gebauer's Ethyl Chloride | Medium Spray, 3.5oz glass bottle | RXETHYL-CHLO | | ✓ | ✓ | |
| | Fine Spray, 3.5oz glass bottle | RXETHYL-FINE | | ✓ | ✓ | |
| Gemfibrozil Tablets | 600mg, 500tablets | RXGEMFIBROZIL | | ✓ | | |
| General Lube | 8oz | RXLUBE-8 | ✓ | | | |
| Genesis Spray | 16oz | RXGENESIS16OZ | ✓ | ✓ | ✓ | |

No returns on pharmaceuticals • Prices change frequently please call for current price • Shipping charges for refrigerated items are a flat charge based on your shipping zone. Customer accepts full responsibility for condition of products upon receipt. ❄️ Indicates Refrigerated Shipping • Pictures are for graphic purposes only, actual product may be different.

| Product | Size/Details | Product Code | Vet Label | RX | Brand | DEA |
|--|--|---------------|-----------|----|-------|-----|
| Gentamicin Injection | 100mg/ml, 100ml | RXGEN100-INJ | ✓ | ✓ | | |
| | 100mg/ml, 250ml | RXGEN250-INJ | ✓ | ✓ | | |
| Gentamicin Ointment | 0.1%, 15gm | RXGENOI-15 | | | | |
| Gentamicin Ophthalmic Ointment | 3.5gm | RXGENOPH-VET | | ✓ | | |
| Gentamicin Ophthalmic Solution | 0.3%, 5ml | RXGENOPH-5 | | ✓ | | |
| Gentamicin Sulfate Cream | 0.1%, 15gm | RXGENCR-15GM | | ✓ | | |
| | 0.1%, 30gm | RXGENCR-30 | | ✓ | | |
| Gentocin Topical Spray | 72ml, 12/pack | RXGENTOCIN72 | ✓ | ✓ | | |
| Geri-Form Chewable Tablets | 150 tablets | RXGERIFORM150 | ✓ | | | |
| Ginkgo Biloba | 50mg, 90 capsules | RXGINK-50 | ✓ | | | |
| | 100mg, 100 capsules | RXGINK-100 | ✓ | | | |
| Glipizide | 10mg, 100 tablets | RXGLIP10-100 | | ✓ | | |
| Glyco-Flex Classic | 300mg, 250 tablets | RXGF300-250 | ✓ | | ✓ | |
| | 300mg, 500 tablets | RXGF300-500 | ✓ | | ✓ | |
| | 600mg, 120 tablets | RXGF600-120 | ✓ | | ✓ | |
| Glyco-Flex I  | 90 tablets | RXGFI-90 | ✓ | | ✓ | |
| | 120 soft chews | RXGFI-120 | ✓ | | ✓ | |
| | Cats, 45 tablets | RXGFC-45 | ✓ | | ✓ | |
| Glyco-Flex II  | 90 tablets | RXGFII-90 | ✓ | | ✓ | |
| | 120 soft chews | RXGFII-120 | ✓ | | ✓ | |
| | Cats, 45 tablets | RXGFII-C-45 | ✓ | | ✓ | |
| | Equine, 120 pellets | RXGFII-EQ-120 | ✓ | | ✓ | |
| Glyco-Flex III  | 90 tablets | RXGFIII-90 | ✓ | | ✓ | |
| | 120 soft chews | RXGFIII-120 | ✓ | | ✓ | |
| Glycopyrrolate | 0.2mg/ml, 20ml | RXGLY20-INJ | | ✓ | | |
| Goodwinol Ointment | 1oz | RXDEMODEC-1 | ✓ | | ✓ | |
| Green-Lyte  | 1 lb with scoop | RXGREEN-LYTE | ✓ | | ✓ | |
| | 3lb with scoop | RXGREEN-LYTE3 | ✓ | | ✓ | |
| Greenies  | Petite Size, 24/pack | RXGRP-24 | ✓ | | ✓ | |
| | Regular Size, 12/pack | RXGRR-14 | ✓ | | ✓ | |
| | Large Size, 8/pack | RXGRL-8 | ✓ | | ✓ | |
| | Jumbo Size, 4/pack | RXGRJ-4 | ✓ | | ✓ | |
| Griseofulvin | 125mg, 100 tablets | RXGRI125-100 | | ✓ | ✓ | |
| | 250mg, 100 tablets | RXGRI250-100 | | ✓ | ✓ | |
| Griseofulvin Oral Suspension | 125mg/5ml, 4 ounce | RXGRI-4OZ | | ✓ | | |
| HCTZ (Hydrochlorothiazide) Tablets | 25mg, 100 tablets | RXHCT225-100 | | ✓ | | |
| | 25mg, 1000 tablets | RXHCT225-1000 | | ✓ | | |
| Heartgard Feline | 5-15lbs, 6 month/card | RXHGP-F | ✓ | ✓ | ✓ | |
| Heartgard Plus Chewables  | Small, 0-25lbs, Blue, 6 month/card | RXHGP-S | ✓ | ✓ | ✓ | |
| | Small, 0-25lbs, Blue, 12 month/card | RXHGP-S-12 | ✓ | ✓ | ✓ | |
| | Medium, 26-50lbs, Green, 6 month/card | RXHGP-M | ✓ | ✓ | ✓ | |
| | Medium, 26-50lbs, Green, 12 month/card | RXHGP-M-12 | ✓ | ✓ | ✓ | |
| | Large, 51-100lbs, Brown, 6 month/card | RXHGP-L | ✓ | ✓ | ✓ | |
| | Large, 51-100lbs, Brown, 12 month/card | RXHGP-L-12 | ✓ | ✓ | ✓ | |
| Heparin | 1000 units/ml, 30ml | RXHEPARIN | | ✓ | | |
| Hetastarch 6% in 0.9% NaCl Injection | 500ml, 12/case | RXHETASTARCH | | ✓ | | |

No returns on pharmaceuticals • Prices change frequently please call for current price • Shipping charges for refrigerated items are a flat charge based on your shipping zone. Customer accepts full responsibility for condition of products upon receipt. ❄️ indicates Refrigerated Shipping • Pictures are for graphic purposes only, actual product may be different.

| Product | Size/Details | Product Code | Vet Label | RX | Brand | DEA |
|---|-----------------------------|-----------------|-----------|----|-------|------|
| Hi-Vite Drops | 1oz | RXHI-VITE | ✓ | | ✓ | |
| Humulin-NPH Insulin * | U-100, 10ml | RXHUMULIN-NPH | | | ✓ | |
| Humulin-R Insulin * | U-100, 10ml | RXHUMULIN-R | | | ✓ | |
| Hyaflex For Dogs | Oral Hyaluronic Acid, 1oz | RXHYAFLEX | ✓ | | ✓ | |
| Hyalovet | 2ml vial | RXHYALOV-2VI | ✓ | ✓ | ✓ | |
| | 2ml syringe | RXHYALOV-2SY | ✓ | ✓ | ✓ | |
| Hyalun For Horses | Oral Hyaluronic Acid, 1oz | RXHYALUN | ✓ | | ✓ | |
| HyCoat | 50mg, 10ml | RXHYCOAT | ✓ | ✓ | | |
| Hydrocodone/APAP (CIII) Tablets  | 5/500mg, 100 tablets | RXVICODIN-100 | | ✓ | | CIII |
| | 5/500mg, 500 tablets | RXVICODIN-500 | | ✓ | | CIII |
| | 10/325mg, 500 tablets | RXNORCO-500 | | ✓ | | CIII |
| | 10/650mg, 500 tablets | RXHYDROCODONE10 | | ✓ | | CIII |
| Hydrocodone/Homatropine (CIII) Syrup | 5-1.5mg/5ml, 16oz | RXHYCODAN16OZ | | ✓ | | CIII |
| Hydrocodone/Ibuprofen (CIII) Tablets | 7.5/200mg, 100 tablets | RXVICOPROFEN | | ✓ | | CIII |
| Hydrocortisone Cream | 1%, 30gm | RXCORT-CRM | | | | |
| | 2.5%, 30 gram | RXCORT2.5-30 | | ✓ | | |
| Hydrocortisone Ointment | 1%, 30gm | RXCORT-OINT | | | | |
| Hydrocortisone Tablets | 20mg, 100 tablets | RXCORT20-100TAB | | ✓ | | |
| Hydrogen Peroxide | 16oz | HYD-P | | | | |
| Hydromorphone (CII) Injection | 2mg/ml, 20ml | RXHYDROMORPH | | ✓ | | CII |
| Hydromorphone (CII) Tablets | 2mg, 100 tablets | RXHYDROMOR2-100 | | ✓ | | CII |
| | 8mg, 100 tablets | RXHYDROMORPH8 | | ✓ | | CII |
| Hydroxyzine HCl Injection | 50mg/ml, 10ml | RXHYDROHCL50INJ | | ✓ | | |
| Hydroxyzine HCL Tablets  | 10mg, 100 tablets | RXHYDROHCL10 | | ✓ | | |
| | 10mg, 500 tablets | RXHYDROHCL100 | | ✓ | | |
| | 25mg, 100 tablets | RXHYDROHCL25 | | ✓ | | |
| | 25mg, 500 tablets | RXHYDROHCL250 | | ✓ | | |
| | 50mg, 100 tablets | RXHYDROHCL50 | | ✓ | | |
| | 50mg, 500 tablets | RXHYDROHCL500 | | ✓ | | |
| Hydroxyzine Pamoate Capsules  | 25mg, 100 capsules | RXHYDR25-100 | | ✓ | | |
| | 25mg, 500 capsules | RXHYDR25-500 | | ✓ | | |
| | 50mg, 100 capsules | RXHYDR50-100 | | ✓ | | |
| | 50mg, 500 capsules | RXHYDR50-500 | | ✓ | | |
| | 100mg, 100 capsules | RXHYDR100-100 | | ✓ | | |
| Hylartin V * | 2ml | RXHYLARTIN-V | ✓ | ✓ | ✓ | |
| Hytril Injection | 6ml | RXHYUINJ-6 | ✓ | ✓ | ✓ | |
| I-Drop Vet | Box of 20 Single Use Allets | RXEYEDROP-20 | ✓ | | ✓ | |
| I-Drop Vet Plus | Box of 20 Single Use Allets | RXEYEDROP-PLUS | ✓ | | ✓ | |
| I-Lid 'n Lash Hygiene Vet | 45gm tube | RXEYELID | ✓ | | ✓ | |
| Ibuprofen Tablets | 600mg, 500 tablets | RXIBU600-500 | | ✓ | | |
| | 800mg, 500 tablets | RXIBU800-500 | | ✓ | | |
| Ichthammol Ointment | 14oz | RXICHTHAMMOL | ✓ | | | |
| Idexx Serum Cups | 250 cups/bag | RXIDEXXSERCUPS | ✓ | | ✓ | |

No returns on pharmaceuticals • Prices change frequently please call for current price • Shipping charges for refrigerated items are a flat charge based on your shipping zone. Customer accepts full responsibility for condition of products upon receipt. ❄️ indicates Refrigerated Shipping • Pictures are for graphic purposes only, actual product may be different.

| Product | Size/Details | Product Code | Vet Label | RX | Brand | DEA |
|---|---|------------------|---------------|----|-------|-----|
| Iidexx Snap Test *  | 4DX for heartworm, ehrlichia, lyme and anaplasmosis, 30 tests/box | R00IDEXX4DX-30 | ✓ | | ✓ | |
| | FELV Antigen Test, 15 tests/box | R00FELV-15D | ✓ | | ✓ | |
| | FELV Antigen Test, 30 tests/box | R00FELV-30D | ✓ | | ✓ | |
| | FeLV Ag/FIV Ab Combo, 15 tests/box | R00COMBO-15D | ✓ | | ✓ | |
| | FeLV Ag/FIV Ab Combo, 30 tests/box | R00COMBO-30D | ✓ | | ✓ | |
| | feline triple (FeLV/FIV/Heartworm) 15 tests/box | R00IDEXX-TRIPLE | ✓ | | ✓ | |
| | Giardia, 15 tests/box | R00GIAR-15D | ✓ | | ✓ | |
| | Heartworm Antigen, 15 tests/box | R00HEART-15D | ✓ | | ✓ | |
| | Heartworm Antigen, 30 tests/box | R00HEART-30D | ✓ | | ✓ | |
| | Parvo Antigen, 5 tests/box | R00PARVO-5D | ✓ | | ✓ | |
| Iidexx Test * | 3DX for heartworm, ehrlichia, lyme, 30 tests/box | R00IDEXX-3DX-30 | ✓ | | ✓ | |
| | Alkaline Phosphatase 25 tests/box | R00IDEXXALP | ✓ | | ✓ | |
| | ALT 25 tests/box | R00IDEXXALT | ✓ | | ✓ | |
| | Amylase 25 tests/box | R00IDEXXAMYL | ✓ | | ✓ | |
| | BUN 25 tests/box | R00IDEXXBUN | ✓ | | ✓ | |
| | CBC5R (LaserCyte) 25 tests/box | R00IDEXXCBC | ✓ | | ✓ | |
| | Creatinine 25 tests/box | R00IDEXXCRE | ✓ | | ✓ | |
| | General Health Profile (GHP), 12 chem/profile, 2 profiles/box | R00IDEXXGHP | ✓ | | ✓ | |
| | Glucose slides, 25 tests/box | R00IDEXXGLU | ✓ | | ✓ | |
| | Lipase 25 tests/box | R00IDEXXLIP | ✓ | | ✓ | |
| | Pre-Anesthetic Profile (PAP), 6 chem/panel, 4 panels/box | R00IDEXXPAP | ✓ | | ✓ | |
| | T4 15 tests/box | R00IDEXXT4 | ✓ | | ✓ | |
| | Iidexx Vet Test Metering Tips | 500/box | R00IDEXX-TIPS | ✓ | | ✓ |
| Immiticide | 5vials/box | R00IMMIT-5 | ✓ | ✓ | ✓ | |
| Interceptor Tablets  | Brown, 2-10lbs, 6 month/pk | R00INT-BR-6 | ✓ | ✓ | ✓ | |
| | Brown, 2-10lbs, 12 month/pk | R00INT-BR-12 | ✓ | ✓ | ✓ | |
| | Green, 11-25lbs, 6 month/pk | R00INT-GR-6 | ✓ | ✓ | ✓ | |
| | Green, 11-25lbs, 12 month/pk | R00INT-GR-12 | ✓ | ✓ | ✓ | |
| | Yellow, 26-50lbs, 6 month/pk | R00INT-YE-6 | ✓ | ✓ | ✓ | |
| | Yellow, 26-50lbs, 12 month/pk | R00INT-YE-12 | ✓ | ✓ | ✓ | |
| | White, 51-100lbs, 6 month/pk | R00INT-WH-6 | ✓ | ✓ | ✓ | |
| | White, 51-100lbs, 12 month/pk | R00INT-WH-12 | ✓ | ✓ | ✓ | |
| Iron Dextran | 100mg, 100ml | R00IRON-100 | ✓ | ✓ | | |
| Isoflurane Inhalant Anesthetic | 100ml | R00ISO-100 | ✓ | ✓ | | |
| | 250ml | R00ISO-250 | ✓ | ✓ | | |
| Isoorbide Dinitrate | 10mg, 100 tablets | R00ISOSORB10-100 | | ✓ | | |
| Isoxsuprine | 20mg, 1000 tablets | R00ISOX20-1000 | ✓ | ✓ | | |
| Itraconazole Capsules | 100mg, 28 capsules | R00TRA100-28 | | ✓ | | |
| Iidexx Max Chewable Tablets | Toy, 6-12lbs, 6 tablets/pack | R00OVER-MAXT6 | ✓ | ✓ | ✓ | |
| | Small, 12.1-25lbs, 6 tablets/pack | R00OVER-MAXS6 | ✓ | ✓ | ✓ | |
| | Medium, 25.1-50lbs, 6 tablets/pack | R00OVER-MAXM6 | ✓ | ✓ | ✓ | |
| | Large, 50.1-100lbs, 6 tablets/pack | R00OVER-MAXL6 | ✓ | ✓ | ✓ | |
| Iidexx Plus  | small, up to 25lbs, 6 tablets/pk | R00OVER-SM | ✓ | ✓ | ✓ | |
| | medium, 26-50lbs, 6 tablets/pk | R00OVER-MED | ✓ | ✓ | ✓ | |
| | large, 51-100lbs, 6 tablets/pk | R00OVER-LG | ✓ | ✓ | ✓ | |

No returns on pharmaceuticals • Prices change frequently please call for current price • Shipping charges for refrigerated items are a flat charge based on your shipping zone. Customer accepts full responsibility for condition of products upon receipt. * Indicates Refrigerated Shipping • Pictures are for graphic purposes only, actual product may be different.

| Product | Size/Details | Product Code | Vet Label | RX | Brand | DEA |
|---|-----------------------|------------------|-----------|----|-------|------|
| Ivermectin Injection | 1%, 50ml | R00VOME | ✓ | | | |
| Ivermectin Paste | 1.87%, 6.08gm | R00VER-PAST | ✓ | | | |
| Ivomec Drench for Sheep | 960ml | R00VO-SHEEP | ✓ | | ✓ | |
| Ivomec Injection for Cattle and Swine | 1%, 50ml | R00VOME-50 | ✓ | | ✓ | |
| Kaolin Pectin | 32oz | R00KA0PEC-32 | ✓ | | | |
| | gallon | R00KA0PEC-GAL | ✓ | | | |
| Kenalog Injection | 10mg/ml, 5ml | R00KENA10-5 | | ✓ | ✓ | |
| | 40mg/ml, 1ml | R00KENA40-1 | | ✓ | ✓ | |
| | 40mg/ml, 5ml | R00KENA40-5 | | ✓ | ✓ | |
| | 40mg/ml, 10ml | R00KENA40-10 | | ✓ | ✓ | |
| Kennel Dip II | 4oz | R00KENDIP-4 | ✓ | | ✓ | |
| | 16oz | R00KENDIP-16 | ✓ | | ✓ | |
| Ketamine (CIII) Injection | 100mg/ml, 10ml | R00KETAMINE | ✓ | ✓ | | CIII |
| Ketochlor Shampoo | 16oz | R00KETOCHLOR | ✓ | | ✓ | |
| Ketoconazole Cream | 2%, 30g | R00KCN-30 | | ✓ | | |
| Ketoconazole Tablets | 200mg, 100 tablets | R00KCN200-100 | | ✓ | | |
| Ketofen Injection | 100mg/ml, 50ml | R00KETO-50 | ✓ | ✓ | ✓ | |
| | 100mg/ml, 100ml | R00KETO-100 | ✓ | ✓ | ✓ | |
| Ketoprofen Capsules | 50mg, 100 capsules | R00KETO50-100 | | ✓ | | |
| Ketorolac SDV | 60mg, 2ml | R00KETOROLAC | | ✓ | | |
| KMR Kitten Milk Replacer | 8oz liquid | R00KMR-8OZ | ✓ | | ✓ | |
| | 11oz liquid | R00KMR-11OZ | ✓ | | ✓ | |
| | 6oz powder | R00KMR-6 | ✓ | | ✓ | |
| | 12oz powder | R00KMR-12 | ✓ | | ✓ | |
| L-Asparaginase * | 10,000 IU, 10ml | R00ELSPAR-10 | | ✓ | | |
| Lactated Ringers IV Solution | 250ml | R00RINGL-250 | | ✓ | | |
| | 500ml | R00RINGL-500 | | ✓ | | |
| | 1000ml | R00RINGL-1000 | | ✓ | | |
| Lactated Ringers with 5% Dextrose IV Solution | 1000ml | R00RINGL-DEX | | ✓ | | |
| Lactulose Solution | 10g/15ml, 16oz | R00LAC-16 | | ✓ | | |
| | 10g/15ml, 32oz | R00LAC-32 | | ✓ | | |
| Lantus Insulin * | U100, 10ml | R00LANTUS | | ✓ | ✓ | |
| Laxatone (Regular Flavor) | 2.5oz | R00LAX-2.5OZ | ✓ | | ✓ | |
| | 4.25oz | R00LAX-4.5OZ | ✓ | | ✓ | |
| Leflunomide | 20mg, 30 tablets | R00LEFLUNOMIDE | | ✓ | | |
| Legend Injection | 10mg/ml, 4ml | R00LEGEND-4ML | ✓ | ✓ | ✓ | |
| Leukeran Tablets * | 2mg, 50 tablets | R00LEUKERAN | | ✓ | | |
| Levothyroxine | 0.1mg, 100 tablets | R00LEVO.1-100 | | ✓ | | |
| | 0.112mg, 100 tablets | R00LEVO.112-100 | | ✓ | | |
| | 0.112mg, 1000 tablets | R00LEVO.112-1000 | | ✓ | | |
| | 0.125mg, 1000 tablets | R00LEVO125-1000 | | ✓ | | |
| | 0.15mg, 1000 tablets | R00LEVO150-1000 | | ✓ | | |
| Levothyroxine Powder | 1lb | R00THYRO-L1 | ✓ | ✓ | | |
| Levothyroxinie | 0.05mg, 100 tablets | R00LEVO50MCG | | ✓ | | |



No returns on pharmaceuticals • Prices change frequently please call for current price • Shipping charges for refrigerated items are a flat charge based on your shipping zone. Customer accepts full responsibility for condition of products upon receipt. * Indicates Refrigerated Shipping • Pictures are for graphic purposes only, actual product may be different.

| Product | Size/Details | Product Code | Vet Label | RX | Brand | DEA |
|----------------------------------|---------------------------|-----------------|-----------|----|-------|-----|
| Levothyroxine Veterinary Chews | 0.1mg, 180 ct | RXLEV-CH1-180 | ✓ | ✓ | | |
| | 0.1mg, 1000 ct | RXLEV-CH1-1000 | ✓ | ✓ | | |
| | 0.2mg, 180ct | RXLEV-CH2-180 | ✓ | ✓ | | |
| | 0.2mg, 1000ct | RXLEV-CH2-1000 | ✓ | ✓ | | |
| | 0.3mg, 180ct | RXLEV-CH3-180 | ✓ | ✓ | | |
| | 0.3mg, 1000ct | RXLEV-CH3-1000 | ✓ | ✓ | | |
| | 0.4mg, 180 ct | RXLEV-CH4-180 | ✓ | ✓ | | |
| | 0.4mg, 1000 ct | RXLEV-CH4-1000 | ✓ | ✓ | | |
| | 0.5mg, 180 ct | RXLEV-CH5-180 | ✓ | ✓ | | |
| | 0.5mg, 1000 ct | RXLEV-CH5-1000 | ✓ | ✓ | | |
| | 0.6mg, 180 ct | RXLEV-CH6-180 | ✓ | ✓ | | |
| | 0.6mg, 1000 ct | RXLEV-CH6-1000 | ✓ | ✓ | | |
| | 0.7mg, 180 ct | RXLEV-CH7-180 | ✓ | ✓ | | |
| | 0.7mg, 1000 ct | RXLEV-CH7-1000 | ✓ | ✓ | | |
| | 0.8mg, 180 ct | RXLEV-CH8-180 | ✓ | ✓ | | |
| 0.8mg, 1000 ct | RXLEV-CH8-1000 | ✓ | ✓ | | | |
| Lidocaine (preservative-free) | 1%, 30ml, pack of 25 | RXLIDO-PF30 | | ✓ | | |
| Lidocaine Ointment & 5% Ointment | 35.44gm tube | RXLIDO-35 | | ✓ | | |
| | 5%, 50gm | RXLIDO-50 | | ✓ | | |
| Lidocaine Injection | 1%, 50ml, for nerve block | RXLIDO1-50 | | ✓ | | |
| | 2%, 50ml, for nerve block | RXLIDO-INJ | | ✓ | | |
| Lidocaine with Epinephrine | 1%, 30ml | RXLIDO1-EPI | | ✓ | | |
| | 2%, 30ml | RXLIDO-EPI | | ✓ | | |
| Lime Plus Dip | 1 gallon | RXLYMDIP-GAL | ✓ | | | |
| Lincocin Aqua Drops | 50mg/ml, 20ml | RXLIN-AQUA | ✓ | ✓ | ✓ | |
| Lincocin Injection | 100mg/ml, 20ml | RXLIN100-20 | ✓ | ✓ | ✓ | |
| | 300mg/ml, 10ml | RXLIN300-10 | ✓ | ✓ | ✓ | |
| Lincocin Tablets | 100mg, 500 tablets | RXLIN100-500 | ✓ | ✓ | ✓ | |
| | 200mg, 250 tablets | RXLIN200-250 | ✓ | ✓ | ✓ | |
| | 500mg, 100 tablets | RXLIN500-100 | ✓ | ✓ | ✓ | |
| Lipo-Form Chewable Tablets | 50 tablets | RXLIPOFORM50 | ✓ | | | |
| | 500 tablets | RXLIPOFORM500 | ✓ | | | |
| Liqui-Tinic 4x | gallon | RXLQUI-TINIC | ✓ | | ✓ | |
| Liqui-Vict 2X Worm Removal | 2oz | RXWORM-2 | ✓ | | | |
| Lisinopril Tablets | 2.5mg, 100 tablets | RXLISINOPRIL2.5 | | ✓ | | |
| | 5mg, 100 tablets | RXLISINOP5-100 | | ✓ | | |
| | 5mg, 1000 tablets | RXLISINOP5-1000 | | ✓ | | |
| | 20mg, 100 tablets | RXLISINOP20-100 | | ✓ | | |
| | 40mg, 100 tablets | RXLISINOP40-100 | | ✓ | | |
| Lisinopril with HCTZ Tablets | 20/12.5mg, 100 tablets | RXLISIN/HCTZ | | ✓ | | |
| Liver-7 Injection * | 100ml | RXLIVER-7 | ✓ | ✓ | ✓ | |
| Lixotinic | 1 gallon | RXLIX-1GAL | ✓ | | ✓ | |
| Loratadine | 10mg, 30 tablets | RXLORATADINE | | | | |
| Lorazepam (CIV) Tablets | 1mg, 100 tablets | RXLORAZEPAM1MG | | ✓ | | CIV |
| | 2mg, 100 tablets | RXLORAZEPAM2MG | | ✓ | | CIV |
| Lorazepam (CIV) Injection | 2mg/ml, 10 x 1ml | RXLORAZ10X1 | | ✓ | | CIV |
| Losartan (generic Cozaar) | 50mg, 90 tablets | RXCOZAAR50-90 | | ✓ | | |

No returns on pharmaceuticals • Prices change frequently please call for current price • Shipping charges for refrigerated items are a flat charge based on your shipping zone. Customer accepts full responsibility for condition of products upon receipt. ❄️ indicates Refrigerated Shipping • Pictures are for graphic purposes only, actual product may be different.



| Product | Size/Details | Product Code | Vet Label | RX | Brand | DEA |
|--|-----------------------------|-----------------|-----------|----|-------|-----|
| Lovenox | 300mg/3ml | RXLLOVENOX | | ✓ | ✓ | |
| Lumicaine Topical Solution | 250mg, 60ml | RXLUMICAINE | | ✓ | ✓ | |
| Lutalyse | 30ml | RXLUTY-30 | ✓ | ✓ | ✓ | |
| Lysodren Tablets | 500mg, 100 tablets | RXLYS500-100 | | ✓ | | |
| Magna Gel | 10 oz. tube | RXMAG-GEL | ✓ | | | |
| Magna-Poultice | 20oz | RXPOUL-200Z | ✓ | | | |
| Malacetic Conditioner | 8oz | RXMAL-CON8 | ✓ | | ✓ | |
| Malacetic Otic | 4oz | RXMALOTIC-4 | ✓ | | ✓ | |
| | 16oz | RXMALOTIC-16 | ✓ | | ✓ | |
| | 12oz | RXMAL-SHM12 | ✓ | | ✓ | |
| Malacetic Shampoo | 16oz | RXMAL-SHM16 | ✓ | | ✓ | |
| | gallon | RXMAL-SHAMG | ✓ | | ✓ | |
| | 5x9 inch wipes, 25/pack | RXMAL-WIPE | ✓ | | ✓ | |
| Malacetic Wet Wipes | 6" X 7" wipes, 100/pack | RXMAL-WIPE100 | ✓ | | ✓ | |
| | | | | | | |
| Mannitol Injection | 20%, 100ml VETERINARY LABEL | RXMANI-100 | ✓ | ✓ | | |
| Marcaine Injection | 0.25%, 50ml | RXMARCAINE25-50 | | ✓ | ✓ | |
| | 0.5%, 50ml | RXMARCAINE50 | | ✓ | ✓ | |
| Marcaine Preservative-Free | 0.5%, 10ml, 10/box | RXMARCAINE10 | | ✓ | ✓ | |
| MASS (Multi-Active Strengthening System) | 32oz | RXMASS-32 | ✓ | | ✓ | |
| Meclizine | 12.5mg, 100 tablets | RXMECLIZINE | | ✓ | | |
| Medrol Tablets | 4mg, 500 tablets | RXMEDROL4MG | ✓ | ✓ | ✓ | |
| Medroxyprogesterone (Generic Depo-Provera) | 150mg/ml, 1ml | RXDEPO-P150-1 | | ✓ | | |
| Megestrol Acetate Tablets | 10mg, 100 tablets | RXMEGACETATE | | ✓ | | |
| Meloxicam Tablets | 7.5mg, 100 tablets | RXMELOX7.5-100 | | ✓ | | |
| | 15mg, 100 tablets | RXMELOX15-100 | | ✓ | | |
| Metacam Injection | 5mg/ml, 10ml | RXMETA-INJ | ✓ | ✓ | ✓ | |
| Metacam Oral Suspension | 10ml | RXMETA-10 | ✓ | ✓ | ✓ | |
| | 32ml | RXMETA-32 | ✓ | ✓ | ✓ | |
| | 100ml | RXMETA-100 | ✓ | ✓ | ✓ | |
| | 0.5mg/ml, 15ml | RXMETA0.5-15 | ✓ | ✓ | ✓ | |
| Metformin ER Tablets | 500mg, 100 tablets | RXMETFOR-ER500 | | ✓ | | |
| Metformin HCl Tablets | 1000mg, 100 tablets | RXMETFORMIN | | ✓ | | |
| Methazolamide | 50mg, 100 tablets | RXMETHAZOL50 | | ✓ | | |
| Methergine Tablets | 0.2mg, 100 tablets | RXMETHERGINE | | ✓ | | |
| Methigel | 4.25 oz | RXMETHIGEL | ✓ | ✓ | ✓ | |
| Methimazole Tablets | 5mg, 100 tablets | RXMETHI5-100 | | ✓ | | |
| | 10mg, 100 tablets | RXMETHI10-100 | | ✓ | | |
| Methocarbamol (Robaxin) Injection | 10ml | RXMETHO-INJ | | ✓ | | |
| Methocarbamol Tablets | 500mg, 100 tablets | RXMET500-100 | | ✓ | | |
| | 500mg, 500 tablets | RXMET500-500 | | ✓ | | |
| | 750mg, 500 tablets | RXMET750-500 | | ✓ | | |
| Methylprednisolone | 4mg, 100 tablets | RXMPRED4-100 | | ✓ | | |
| Methylprednisolone Injection | 40mg/ml, 5ml | RXMPRED40-5 | | ✓ | | |
| | 5mg, 100 tablets | RXMTCL5-100 | | ✓ | | |
| | 10mg, 100 tablets | RXMTCL10-100 | | ✓ | | |
| Metoclopramide HCl Tablets | 10mg, 500 tablets | RXMTCL10-500 | | ✓ | | |
| | | | | | | |









| Product | Size/Details | Product Code | Vet Label | RX | Brand | DEA |
|---|-----------------------------|-----------------|-----------|----|-------|-----|
| Metoclopramide Injection | 5mg/ml, 2ml | R0MTCL-INJ2 | | ✓ | | |
| Metoclopramide Oral Liquid | 5mg/5ml, 16oz | R0MTCL-LIQ | | ✓ | | |
| Metoprolol ER | 50mg, 100 tablets | R0METOP50-100 | | ✓ | | |
| Metoprolol Tartrate | 25mg, 100 tablets | R0METOP25-100 | | ✓ | | |
| | 100mg, 100 tablets | R0METOP100-100 | | ✓ | | |
| Metronidazole Injection | 500mg, 100ml, 4/pack | R0MTN-INJ | | ✓ | | |
| Metronidazole Tablets | 250mg, 250 tablets | R0MTN250-250 | | ✓ | | |
| | 250mg, 500 tablets | R0MTN250-500 | | ✓ | | |
| | 500mg, 100 tablets | R0MTN500-100 | | ✓ | | |
| | 500mg, 500 tablets | R0MTN500-500 | | ✓ | | |
| Mexiletine | 200mg, 100 capsules | R0MEXIL200-100 | | ✓ | | |
| Miconazole Nitrate Cream | 2%, 1oz | R0MIC-10Z | | | | |
| Miconosol Lotion/Spray | 1%, 60ml | R0MICONAZ-SP60 | ✓ | ✓ | | |
| | 1%, 120ml | R0MICONAZ-SP | ✓ | ✓ | | |
| Midazolam (CIV) Injection | 5mg/ml, 10ml, 10 vials/pack | R0MIDAZ-10X10 | | ✓ | | CIV |
| Mineral Oil | gallon | R0MIN-95 | ✓ | | | |
| Minocycline | 100mg, 50 capsules | R0MINOCY100-50 | | ✓ | | |
| | 100mg, 500 capsules | R0MINOCY100-500 | | ✓ | | |
| Minoxidil | 10mg, 100 tablets | R0MINOX10-100 | | ✓ | | |
| | 10mg, 500 tablets | R0MINOX10-500 | | ✓ | | |
| Miracle Sand Out Pellets | 5lb | R0XSAND-OUT | ✓ | | ✓ | |
| Mirtazapine Tablets | 15mg, 30 tablets | R0MIRTAZ15-30 | | ✓ | | |
| | 30mg, 30 tablets | R0MIRTAZ30-30 | | ✓ | | |
| Missing Link Plus Joint Support Professional Strength Formula | canine, 1lb | R0MISS-LINK-PL | ✓ | | ✓ | |
| Mitaban (Amitraz) Dip | 10.6ml | R0MITABAN | ✓ | ✓ | ✓ | |
| Mometamax | 7.5gm | R0MOMETAMAX | ✓ | ✓ | ✓ | |
| | 15gm | R0MOMETAMAX15 | ✓ | ✓ | ✓ | |
| Morphine (CII) Sulfate Injection | 15mg/ml, 20ml | R0MORPHINE | | ✓ | | CII |
| MSM | 1lb | R0MSM-1LB | ✓ | | | |
| | 2lb | R0MSM-2LB | ✓ | | | |
| Mupirocin (generic Bactroban) Ointment | 2%, 22gm | R0BACTROBAN | | ✓ | | |
| Nalbuphine HCl Injection | 10mg/ml, 10ml, 25/pack | R0NALB-24 | | ✓ | | |
| Naloxone HCl Injection | 0.4mg/ml, 1ml vial, 10/pack | R0NALOXONE | | ✓ | | |
| Naproxen | 500mg, 100 tablets | R0NAPRO500-100 | | ✓ | | |
| | 500mg, 500 tablets | R0NAPRO500-500 | | ✓ | | |
| Naproxen Delayed Release EC | 500mg, 100 tablets | R0NAPRO-EC | | ✓ | | |
| Nasalgen IP Vaccine * | 10 dose tank | R0NASALGEN | ✓ | ✓ | ✓ | |
| | 10 x 1 dose | R0NASALGEN-IP | ✓ | ✓ | ✓ | |
| Naxcel Sterile Powder | 1gm with water | R0NAX-1 | ✓ | ✓ | ✓ | |
| | 4gm | R0NAX-4 | ✓ | ✓ | ✓ | |
| Neo-predef Topical Powder | 15 gram | R0NEOPREDEF | ✓ | ✓ | ✓ | |
| Neo/Poly/Bac Ophthalmic Ointment | 3.5gm | R0TRIPOP-3.5GM | | ✓ | | |
| Neomycin/Polymixin/Bacitracin with Hydrocortisone Ophthalmic Ointment | 3.5gm | R0VET-PHC | ✓ | ✓ | | |
| | 3.5gm | R0NPB-HC | | ✓ | | |
| Neo/Poly/Dex Ophthalmic Ointment | 3.5gm | R0MAXOPH-3.5 | | ✓ | | |
| Neo/Poly/Dex Ophthalmic Suspension | 5ml | R0MAXOPH-5 | | ✓ | | |
| Neomycin, Polymixin B, Hydrocortisone Otic Solution | 10ml | R0NPHOTIC-10 | | ✓ | | |







No returns on pharmaceuticals • Prices change frequently please call for current price • Shipping charges for refrigerated items are a flat charge based on your shipping zone. Customer accepts full responsibility for condition of products upon receipt. * Indicates Refrigerated Shipping • Pictures are for graphic purposes only, actual product may be different.

| Product | Size/Details | Product Code | Vet Label | RX | Brand | DEA |
|--|--------------------------------------|-----------------|-----------|----|-------|-----|
| NFZ Wound Powder | 45grams | RXNITRO-45 | ✓ | ✓ | | |
| Niacinamide | 500mg, 110 tablets | RXNIA500-100 | | ✓ | | |
| Nitrofurantoin Mono/Macro (Generic Macrobid) | 100mg, 100 capsules | RXMACROBID | | ✓ | | |
| Nitrofurazone Dressing | 1lb | RXNITRO-DRES | ✓ | | | |
| Nolvasan Otic | 4oz | RXNOLV-OTIC4 | ✓ | | ✓ | |
| Nolvasan S Cleaner | 1 pint | RXNOLS-16 | ✓ | | ✓ | |
| Nolvasan Shampoo with Conditioner | 8oz | RXNOLVSHAMPOO | ✓ | | ✓ | |
| Nolvasan Skin and Wound Cleanser | 8oz | RXNOLV-WOUND8OZ | ✓ | | ✓ | |
| Normosol-R IV Fluids | 1000ml | RXNORMOSOL-R | ✓ | ✓ | ✓ | |
| Novox (Carprofen) Caplets  | 25mg, 60 caplets | RXNOVOX25-60 | ✓ | ✓ | | |
| | 25mg, 180 caplets | RXNOVOX25-180 | ✓ | ✓ | | |
| | 75mg, 60 caplets | RXNOVOX75-60 | ✓ | ✓ | | |
| | 75mg, 180 caplets | RXNOVOX75-180 | ✓ | ✓ | | |
| | 100mg, 60 caplets | RXNOVOX100-60 | ✓ | ✓ | | |
| | 100mg, 180 caplets | RXNOVOX100-180 | ✓ | ✓ | | |
| Nuflor (Florfenicol) Injection | 100ml | RXNUFLOR | ✓ | ✓ | ✓ | |
| NurseMate Foal | 1 dose tube | RXNURSEFOA-1 | ✓ | | | |
| Nursing Bottle Kit | 2oz bottle, cap, 2 nipples and brush | RXNURTURALL-BOT | ✓ | | | |
| Nurturall C Puppies | 8oz liquid | RXNURTURALL-P8 | ✓ | | ✓ | |
| Nutrical Vitamin Gel | 4.25oz tube | RXNUVI-4.25 | ✓ | | ✓ | |
| Nystatin Cream | 30gm | RXNYS-PLAIN | | ✓ | | |
| Nystatin with Triamcinolone Ointment | 30gm | RXNYS-30 | | ✓ | | |
| O.F.A. Plus Garlic | up to 30lbs, 60 capsules | RXOFAGAR-30 | ✓ | | | |
| | 50-70lbs, 60 capsules | RXOFAGAR-50 | ✓ | | | |
| Ofloxacin Ophthalmic Solution | 0.3%, 5ml | RXOFLOXACIN-OPH | | ✓ | | |
| Omega 3 Gel Caps | Small Dog, 60 gelcaps | RXOMESD-60 | ✓ | | | |
| | Large Dog, 60 gelcaps | RXOMELD-60 | ✓ | | | |
| Omeprazole | 20mg, 30 capsules | RXOMEPRAZOLE | | ✓ | | |
| Ondansetron for Injection | 2mg/ml, 5x2ml | RXZOF-INJ | | ✓ | | |
| Ondansetron ODT | 4mg, 30 tablets | RXZOF-ODT | | ✓ | | |
| Ondansetron Tablets | 4mg, 30 tablets | RXZOF4-30 | | ✓ | | |
| Opti-Vet Eye Drops | 0.5 oz | RXHY-OPTIC | ✓ | | ✓ | |
| Optimmune Ophthalmic Ointment | 1/8oz tube | RXOPTI-1/8OZ | ✓ | ✓ | ✓ | |
| Oral Amino Acid Concentrate | 500ml | RXAMINO-500 | ✓ | ✓ | | |
| Orbax (Orbifloxacin) Tablets  | 5.7mg, 250 tablets | RXORBAX-5.7 | ✓ | ✓ | ✓ | |
| | 22.7mg, 250 tablets | RXORBAX-22.7 | ✓ | ✓ | ✓ | |
| | 68mg, 100 tablets | RXORBAX68-100 | ✓ | ✓ | ✓ | |
| Osteochon Joint Care  | 2.5lb powder | RXOSTEO-POW | ✓ | | ✓ | |
| | 6 yearling/12 foal paste | RXOSTEO-PAST | ✓ | | ✓ | |
| Osteoform | 500 tablets | RXOSTEOFORM | ✓ | ✓ | | |
| Oticare A Ear Cleaner | 4oz | RXOTIC66704 | ✓ | | | |
| Oticare P Ear Powder | 6 gram | RXOTIC66606 | ✓ | | | |

No returns on pharmaceuticals • Prices change frequently please call for current price • Shipping charges for refrigerated items are a flat charge based on your shipping zone. Customer accepts full responsibility for condition of products upon receipt. ❄️ Indicates Refrigerated Shipping • Pictures are for graphic purposes only, actual product may be different.

| Product | Size/Details | Product Code | Vet Label | RX | Brand | DEA |
|---|------------------------------------|-----------------|-----------|----|-------|-----|
| Otisothe II Ear Cleaner  | 16oz | RXOTIC66716 | ✓ | | | |
| | 7.5gm | RXOTOMAX7.5 | ✓ | ✓ | ✓ | |
| Otomax Ointment | 8oz bottle | RXOTOM-8 | ✓ | ✓ | ✓ | |
| | 15gm | RXOTOMAX15 | ✓ | ✓ | ✓ | |
| | | | | | | |
| Outlast Spray | 32oz | RXOUTLAST32 | ✓ | | ✓ | |
| Ovassay Plus | Kit with Solution | RXOVASSAY-KIT | | | | |
| Oxytocin * | 100ml | RXOXY-100 | ✓ | ✓ | | |
| Pad Tough Spray | 4oz | RXPAD-TOUGH | ✓ | | | |
| Panacur C Canine Dewormer | 1gm packet (10lbs), 30 packets/box | RXPANACUR-C10 | ✓ | | ✓ | |
| | 2gm packet (20lbs), 30 packets/box | RXPANACUR-C20 | ✓ | | ✓ | |
| | 4gm packet (40lbs), 30 packets/box | RXPANACUR-C40 | ✓ | | ✓ | |
| Panacur Granules | 1lb | RXPANACUR-LB | ✓ | ✓ | ✓ | |
| Panacur Paste  | 25gm | RXPANA-PASTE | ✓ | ✓ | ✓ | |
| Panacur Powerpac  | 5 pack | RXPANACUR-5 | ✓ | ✓ | ✓ | |
| Panacur Suspension | 10%, 1000ml | RXPANACUR-LT | ✓ | ✓ | ✓ | |
| | 10%, 1 gallon | RXPANACUR-GA | ✓ | ✓ | ✓ | |
| Panakare Plus Tablets | 100 tablets | RXPANA-TAB | ✓ | ✓ | ✓ | |
| Pancrezyme | 8oz | RXPANCREAZYME | ✓ | ✓ | ✓ | |
| Papaverine Injection | 30mg/ml, 10ml | RXPAPAVERINE | | ✓ | | |
| Paragard Shampoo | 32oz | RXPARAGARD | ✓ | | ✓ | |
| Parvosan Disinfectant | gallon | RXPARVOSAN | ✓ | | | |
| Penicillin (long acting) Injection * | 100ml | RXPENLA-100 | ✓ | | | |
| | 250ml | RXPENLA-250 | ✓ | | | |
| Penicillin Injection *  | 100ml | RXPEN-100 | ✓ | | | |
| | 250ml | RXPEN-250 | ✓ | | | |
| | 500ml | RXPEN-500 | ✓ | | | |
| Penicillin VK  | 500mg, 100 tablets | RXPENVK500-100 | | ✓ | | |
| | 500mg, 500 tablets | RXPENVK-500 | | ✓ | | |
| Pentoxyfylline Tablets | 400mg, 100 tablets | RXPENTOX400 | | ✓ | | |
| Percorten-V Injection | 25mg/ml, 4ml | RXPERCORTEN | ✓ | ✓ | ✓ | |
| Pet-form Chewable Tablets | 50 tablets | RXPETFORM-50 | ✓ | | ✓ | |
| | 150 tablets | RXPETFORM150 | ✓ | | | |
| | 500 tablets | RXPETFORM500 | ✓ | | | |
| Petchek Heartworm PF Antigen Test * | 192 tests/box | RXPETCHEK-D | ✓ | | ✓ | |
| Phenobarbital (CIV) Tablets  | 15mg, 1000 tablets | RXPHENO-1/4G | | ✓ | | CIV |
| | 30mg, 100 tablets | RXPHENO-1/2G | | ✓ | | CIV |
| | 30mg, 1000 tablets | RXPHENO30-1000 | | ✓ | | CIV |
| | 60mg, 1000 tablets | RXPHENO60-1000 | | ✓ | | CIV |
| Phenol EZ Swabs | 30 swabs/pack | RXPHENOL-EZ | | ✓ | ✓ | |
| Phenylbutazone Injection * | 20%, 100ml | RXBUT-INJ | ✓ | ✓ | | |
| Phenylbutazone Paste | 12gm | RXBUT-PASTE | ✓ | ✓ | | |
| Phenylbutazone Tablets | 1gm, 100 tablets | RXBUT1GM-100 | ✓ | ✓ | | |
| Phenylephrine HCl Ophthalmic Solution * | 2.5%, 5ml | RXPHENYLEPH-OPH | | ✓ | | |
| Pilocarpine HCl Ophthalmic Solution | 4%, 15ml | RXPIL4-15 | | ✓ | | |
| | 2%, 15ml | RXPIL2-15 | | ✓ | | |
| Piperazine Paste Canine Anthelmintic | 13 gm. | RXPIPER-CA13 | | | | |

| Product | Size/Details | Product Code | Vet Label | RX | Brand | DEA |
|---|-------------------------------------|-----------------|-----------|----|-------|-----|
| Piperazine Paste Feline Anthelmintic | 4 gm | RXPIPER-FE4 | ✓ | | | |
| Piroxicam Capsules | 10mg, 100 capsules | RXPIRO10-100 | | ✓ | | |
| | 20mg, 100 capsules | RXPIRO20-100 | | ✓ | | |
| Pirsue Mastitis Tubes | 12 Tubes/pk | RXPIRSUE-12 | ✓ | ✓ | ✓ | |
| Polyglycan Injection | 10ml | RXPOLYGLYCAN | ✓ | ✓ | | |
| Polymixin B Sulf and Trim Ophthalmic Solution | 10ml | RXTRIM-10 | | ✓ | | |
| Potassium Chloride Injection | 20meq, 10ml | RXPOT-CHL | | ✓ | | |
| | 40meq/ml, 20ml, 25/pack | RXPOT-CHL25X40 | | ✓ | | |
| Potassium Citrate | 10meq, 100 tablets | RXUROCIT-K | | ✓ | | |
| | 640mg, 100 tablets | RXPOT-CIT | ✓ | ✓ | | |
| Potassium Citrate Cranberry Granules | | RXPOT-CITCG | ✓ | ✓ | | |
| Potassium Gluconate | 200mg, 120 tablets | RXPOT-GLU | ✓ | ✓ | | |
| PPA (Phenylpropanolamine) Tablets  | 25mg, 100 tablets | RXPPA25-100 | ✓ | ✓ | | REP |
| | 50mg, 100 tablets | RXPPA50-100 | ✓ | ✓ | | REP |
| | 50mg, 1000 tablets | RXPPA50-1000 | ✓ | ✓ | | REP |
| | 75mg, 100 tablets | RXPPA75-100 | ✓ | ✓ | | REP |
| PPD (Purified Protein Derivative) Test * | 10 test vial | RXPPD-10 | | ✓ | | |
| Prednisolone Acetate Ophthalmic Suspension | 1%, 5ml | RXPDOPH-5 | | ✓ | | |
| | 1%, 10ml | RXPDOPH-10 | | ✓ | | |
| | 1%, 15ml | RXPDOPH-15 | | ✓ | | |
| Prednisolone Syrup | 15mg/5ml, 16 oz | RXPREDNIS16OZ | | ✓ | | |
| Prednisone Tablets  | 5mg, 100 tablets | RXPRED5-100 | | ✓ | | |
| | 5mg, 1000 tablets | RXPRED5-K | | ✓ | | |
| | 10mg, 100 tablets | RXPRED10-100 | | ✓ | | |
| | 10mg, 1000 tablets | RXPRED10-1000 | | ✓ | | |
| | 20mg, 100 tablets | RXPRED20-100 | | ✓ | | |
| | 20mg, 1000 tablets | RXPRED20-K | | ✓ | | |
| Primex Canine 2X | 2 oz. | RXPYRAN-2K9 | ✓ | | | |
| Primidone Tablets | 250mg, 100 tablets | RXPRIMIDONE250 | | ✓ | | |
| Primor | 600mg, 100 tablets | RXPRIMOR600 | ✓ | ✓ | ✓ | |
| | 1200mg, 100 tablets | RXPRIMOR1200 | ✓ | ✓ | ✓ | |
| Privasan Antiseptic Ointment | 1oz | RXPRNASAN-1 | ✓ | | | |
| Pro-Zinc Insulin * | for Cats, 40 units/ml, 10ml | RXPRO-ZINC | ✓ | ✓ | | |
| ProAir HFA Albuterol Inhaler | 90mcg | RXPROAIR | | ✓ | | |
| Probiotic Gel for Small Animals | 15gm | RXPROBIOTIC-15 | ✓ | | | |
| Prochlorperazine Injection  | 5mg/ml, 2ml | RXCOMPАЗINE2ML | | ✓ | | |
| | 5mg/ml, 2ml x 10 vials/pack | RXCOMPАЗINE-INJ | | ✓ | | |
| Profender for Cats | Small, 2.2-5.5lbs, 0.35ml, 40/box | RXPROFEND-SM | ✓ | ✓ | ✓ | |
| | Medium, 5.6-11lbs, 0.7ml, 40/box | RXPROFEND-M | ✓ | ✓ | ✓ | |
| | Large, 11.1-17.6lbs, 1.12ml, 24/box | RXPROFEND-LG | ✓ | ✓ | ✓ | |
| Progesterone in Oil | 50mg/ml, 10ml | RXPROGE50-10 | | ✓ | | |
| Program Flavor Tablets for Cats  | Green, 0-6lbs, 6 tablets/pack | RXPROGFEL6-6TAB | ✓ | | ✓ | |
| | Yellow, 7-15lbs, 6 tablets/pack | RXPROGFEL15-6TA | ✓ | | ✓ | |
| Program Flavor Tablets for Dogs  | Green (11-20lbs), 6 tablets/box | RXPROG-GREEN | ✓ | | ✓ | |
| | Yellow (21-45lbs), 6 tablets/box | RXPROG-YELLOW | ✓ | | ✓ | |
| | White (46-90lbs), 6 tablets/box | RXPROG-WHITE | ✓ | | ✓ | |

No returns on pharmaceuticals • Prices change frequently please call for current price • Shipping charges for refrigerated items are a flat charge based on your shipping zone.

Customer accepts full responsibility for condition of products upon receipt. ❄️ Indicates Refrigerated Shipping • Pictures are for graphic purposes only, actual product may be different.





13822 WEST BOULTON BLVD. METTAWA, IL 60045

WWW.SHOPMEDVET.COM

Phone 800-544-7521

30

Fax 800-204-2177

| Product | Size/Details | Product Code | Vet Label | RX | Brand | DEA |
|--|----------------------------|----------------------------|----------------|----|-------|-----|
| Program Suspension for Cats | 0-10lbs, 6/pack | RXPROGFEL10-6 | ✓ | | ✓ | |
| | 11-20lbs, 6/pack | RXPROGFEL20-6 | ✓ | | ✓ | |
| Proin (Phenylpropanolamine) Tablets  | 25mg, 60 chewable tablets | RXPROIN25-60 | ✓ | ✓ | ✓ | REP |
| | 50mg, 60 tablets | RXPROIN50-60 | ✓ | ✓ | ✓ | REP |
| | 50mg, 180 chewable tablets | RXPROIN50-180 | ✓ | ✓ | ✓ | REP |
| | 75mg, 60 tablets | RXPROIN75-60 | ✓ | ✓ | ✓ | REP |
| | Promethazine Injection | 25mg/ml, 1ml vial, 25/pack | RXPROMETH-INJ2 | | ✓ | |
| Promethazine Plain | 6.25mg/5ml, 16oz | RXPROMETH16OZ | | ✓ | | |
| Promethazine Tablets | 25mg, 100 tablets | RXPROMETHAZINE | | ✓ | | |
| Propalin Chew Tablets  | 25mg, 60 chewable tablets | RXPROP25-60 | ✓ | ✓ | ✓ | REP |
| | 50mg, 60 chewable tablets | RXPROP50-60 | ✓ | ✓ | ✓ | REP |
| | 50mg, 180 chewable tablets | RXPROP50-180 | ✓ | ✓ | ✓ | REP |
| | 75mg, 60 chewable tablets | RXPROP75-60 | ✓ | ✓ | ✓ | REP |
| Proparacaine HCL Ophthalmic Suspension * | 0.5%, 15ml | RXPROOPH-15 | | ✓ | | |
| Propofol | 1%, 50ml, pack of 20 | RXPROPOFOL-50 | | ✓ | | |
| | 10mg/ml, 20ml | RXPROPOFOL | | ✓ | | |
| Propoxyphene NAPS/APAP (CIV) (Generic Darvocet N)  | 100/650mg, 100 tablets | RXDARVOCET | | ✓ | | CIV |
| Propranolol Tablets  | 20mg, 100 tablets | RXPROP20-100 | | ✓ | | |
| | 40mg, 100 tablets | RXPROP40-100 | | ✓ | | |
| Propranolol Injection | 1mg, 10 x 1ml/bx | RXPROPRAN-INJ | | ✓ | | |
| Propylene Glycol | 1 gallon | RXPROGLYCOL | ✓ | | | |
| Proud Flesh Powder | 6oz | RXPROUDFLESH | ✓ | | | |
| Provable Capsules for Dogs and Cats | 80 capsules | RXPROVABLE-CAP | ✓ | | ✓ | |
| Puppy Paste | 13 gram syringe | RXWORM-PASTE | ✓ | | | |
| Pyoben Shampoo | 8oz | RXPYOBEN-8 | ✓ | | ✓ | |
| Pyrantel Pamoate Suspension | 32oz | RXPYRANTEL | ✓ | | | |
| | 1 gallon | RXPYRANTEL-GAL | ✓ | | | |
| Pyridostigmine Bromide Tablets | 60mg, 100 tablets | RXPYRID60-100 | | ✓ | | |
| Quartermaster Tube | 10ml, 12/pack | RXQUARTER | ✓ | ✓ | ✓ | |
| Quest | 11.3gm | RXQUEST-11.3 | ✓ | | ✓ | |
| Quinapril  | 10mg, 90 tablets | RXACCUPRIL10-90 | | ✓ | | |
| | 20mg, 90 tablets | RXACCUPRIL20-90 | | ✓ | | |
| Ranitidine Tablets | 150mg, 100 tablets | RXZAN150-100 | | ✓ | | |
| | 300mg, 100 tablets | RXZAN300-100 | | ✓ | | |
| | 300mg, 250 tablets | RXZAN300-250 | | ✓ | | |
| Regu-Mate | dispensing gun | RXREGU-DISPGUN | ✓ | | | |
| | 1000ml | RXREGUMATE-K | ✓ | ✓ | ✓ | |
| Renakare (Potassium Gluconate) | 2meq, 100 tablets | RXRENA2-100 | ✓ | ✓ | ✓ | |
| Renakare Gel | 5oz | RXRENAKARE-GEL | ✓ | ✓ | ✓ | |
| Renal K+ Gel | 5oz | RXRENAL-K | ✓ | ✓ | ✓ | |
| Resi-Chlor Lotion | 8 oz | RXRESI-CHLOR | ✓ | ✓ | ✓ | |
| Resi-Cort Leave on Lotion | 8 oz | RXRESI-CORT | ✓ | ✓ | ✓ | |

No returns on pharmaceuticals • Prices change frequently please call for current price • Shipping charges for refrigerated items are a flat charge based on your shipping zone. Customer accepts full responsibility for condition of products upon receipt. ❄️ indicates Refrigerated Shipping • Pictures are for graphic purposes only, actual product may be different.



13822 WEST BOULTON BLVD. METTAWA, IL 60045

WWW.SHOPMEDVET.COM

Phone 800-544-7521

31

Fax 800-204-2177

| Product | Size/Details | Product Code | Vet Label | RX | Brand | DEA |
|---|---------------------------------|----------------|-----------|----|-------|-----|
| Respiram (Doxapram) Injection | 20mg/ml, 20ml | RXRESPIRAM | ✓ | ✓ | ✓ | |
| Revalor S | Box of 10x10 cartridge implants | RXREVALOR-S | ✓ | | ✓ | |
| Revolution for Cats | Blue, 5-15lbs, 3 months/box | RXREV-BLU3 | ✓ | ✓ | ✓ | |
| | Blue, 5-15lbs, 6 months/box | RXREV-BLU | ✓ | ✓ | ✓ | |
| Revolution for Dogs  | Purple, 5-10lbs, 3 month/pack | RXREV-PUR3 | ✓ | ✓ | ✓ | |
| | Purple, 5-10lbs, 6 months/box | RXREV-PUR | ✓ | ✓ | ✓ | |
| | Brown, 10-20lbs, 3 months/pack | RXREV-BROW3 | ✓ | ✓ | ✓ | |
| | Brown, 10-20lbs, 6 months/box | RXREV-BROW | ✓ | ✓ | ✓ | |
| | Red, 20-40lbs, 6 months/box | RXREV-RED | ✓ | ✓ | ✓ | |
| | Teal, 40-85lbs, 6 months/box | RXREV-TEAL | ✓ | ✓ | ✓ | |
| | Plum, 85-130lbs, 3 months/box | RXREV-PLUM | ✓ | ✓ | ✓ | |
| Revolution for Puppies and Kittens | Mauve, up to 5lbs, 3 months/box | RXREV-MAUVE3 | ✓ | ✓ | ✓ | |
| Rimadyl | 100mg chew tabs, pack of 4 | RXRIM-PAINPACK | ✓ | ✓ | ✓ | |
| Rimadyl Caplets | 75mg, 60 caplets | RXRIM75-60CAP | ✓ | ✓ | ✓ | |
| | 100mg, 60 caplets | RXRIM100-60CAP | ✓ | ✓ | ✓ | |
| Rimadyl Chew Tablets  | 25mg, 60 chew tablets | RXRIM25-60 | ✓ | ✓ | ✓ | |
| | 75mg, 60 chew tablets | RXRIM75-60 | ✓ | ✓ | ✓ | |
| | 75mg, 180 chew tablets | RXRIM75-180 | ✓ | ✓ | ✓ | |
| | 100mg, 60 chew tablets | RXRIM100-60 | ✓ | ✓ | ✓ | |
| | 100mg, 180 chew tablets | RXRIM100-180 | ✓ | ✓ | ✓ | |
| | Rimadyl Injection * | 20ml | RXRIM-INJ | ✓ | ✓ | ✓ |
| Rubenal | 300mg, 60 count | RXRUBEN300-60 | ✓ | ✓ | ✓ | |
| | 75mg, 60 count | RXRUBEN75-60 | ✓ | ✓ | ✓ | |
| Sandimmune Brand Cyclosporine | 25mg, 30 tablets | RXSANDIMMUNE | | ✓ | ✓ | |
| Scarlet Oil | 16oz | RXSCAR-DRE4 | ✓ | | | |
| | 1 gallon | RXSCAR-1GAL | ✓ | | | |
| Schirmer Tear Test | 50 strips per box | RXSCHIRMER50 | ✓ | | ✓ | |
| Sebolux Shampoo | 8 oz | RXSEBOLUX-8 | ✓ | | ✓ | |
| Selegiline Capsules | 5mg, 60 capsules | RXSELE5-60 | | ✓ | | |
| Selenium Sulfide Shampoo/Lotion | 2.5%, 120ml | RXSELSUN | | ✓ | | |
| Sentinel Chewable Tablets  | Brown, 2-10lbs, 6 months/box | RXSEN-RE-6 | ✓ | ✓ | ✓ | |
| | Brown, 2-10lbs, 12 months/box | RXSEN-BR-12 | ✓ | ✓ | ✓ | |
| | Green, 11-25lbs, 6 months/box | RXSEN-GR-6 | ✓ | ✓ | ✓ | |
| | Green, 11-25lbs, 12 months/box | RXSEN-GR-12 | ✓ | ✓ | ✓ | |
| | Yellow, 26-50lbs, 6 months/box | RXSEN-YE-6 | ✓ | ✓ | ✓ | |
| | Yellow, 26-50lbs, 12 months/box | RXSEN-YE-12 | ✓ | ✓ | ✓ | |
| | White, 51-100lbs, 6 months/box | RXSEN-WH-6 | ✓ | ✓ | ✓ | |
| | White, 51-100lbs, 12 months/box | RXSEN-WH-12 | ✓ | ✓ | ✓ | |
| Sertraline HCl | 50mg, 30 tablets | RXSERT50-30 | | ✓ | | |
| | 100mg, 30 tablets | RXSERT100-30 | | ✓ | | |
| Sevoflurane Inhalant Anesthetic | 250ml | RXSEVO-250 | ✓ | ✓ | | |
| Shed-Guard Anti-Shedding Wipes | 8/pack | RXWIPE-SHED | ✓ | | | |
| Silver Sulfadiazine Cream | 1%, 25 gram tube | RXSSD-25 | | ✓ | | |
| | 1%, 50 gram jar | RXSSD-50 | | ✓ | | |
| | 1%, 400 gram jar | RXSSD-400 | | ✓ | | |

No returns on pharmaceuticals • Prices change frequently please call for current price • Shipping charges for refrigerated items are a flat charge based on your shipping zone. Customer accepts full responsibility for condition of products upon receipt. ❄️ Indicates Refrigerated Shipping • Pictures are for graphic purposes only, actual product may be different.

| Product | Size/Details | Product Code | Vet Label | RX | Brand | DEA |
|-------------------------------------|---|----------------------|----------------|------------|-------|-----|
| Silverlon Contact Dressing | 4"x42" roll, 2 rolls/box | RXSILVER-ST | ✓ | | ✓ | |
| Silveron Wound Packing | 1"x24" , 2 packs/box | RXSILVER-PK | ✓ | | ✓ | |
| Simplicef (cefepodoxime) Tablets | 100mg, 100 tablets | RXSIMPLICEF100 | ✓ | ✓ | ✓ | |
| | 200mg, 100 tablets | RXSIMPLICEF200 | ✓ | ✓ | ✓ | |
| Simvastatin Tablets | 5mg, 90 tablets | RXSIMV5-90 | | ✓ | | |
| | 20mg, 90 tablets | RXSIMV20-90 | | ✓ | | |
| Slow Release CMPK Boluses | 1x50 boluses/pk | RXCMPK-50 | ✓ | | | |
| Sodium Bicarbonate | 8.4%, 50ml | RXNUET-50 | | ✓ | | |
| Sodium Chloride Ophthalmic Ointment | 5%, 3.5gm | RXNACL-OPH | | ✓ | | |
| Sodium Iodide | 20%, 250ml | RXSOD-IOD | ✓ | ✓ | | |
| Sodoxine Tablets |  | 0.1mg, 1000 tablets | RXSOLX.1-1000 | ✓ | ✓ | ✓ |
| | | 0.2mg, 250 tablets | RXSOLX.2-250 | ✓ | ✓ | ✓ |
| | | 0.2mg, 1000 tablets | RXSOLX.2-1000 | ✓ | ✓ | ✓ |
| | | 0.4mg, 250 tablets | RXSOLX.4-250 | ✓ | ✓ | ✓ |
| | | 0.5mg, 250 tablets | RXSOLXINE0.5 | ✓ | ✓ | ✓ |
| | | 0.6mg, 250 tablets | RXSOLX0.6-250 | ✓ | ✓ | ✓ |
| | | 0.7mg, 250 tablets | RXSOLX.7-250 | ✓ | ✓ | ✓ |
| | | 0.8mg, 250 tablets | RXSOLX0.8-250 | ✓ | ✓ | ✓ |
| | | 0.8mg, 1000 tablets | RXSOLX0.8-1000 | ✓ | ✓ | ✓ |
| | | Solu Delta Cortef | 100mg/ml, 10ml | RXSOLU-100 | ✓ | ✓ |
| 500mg/ml, 10ml | RXSOLU-500 | | ✓ | ✓ | ✓ | |
| Solu-Medrol | 500mg, 4ml Act-O-Vial | RXSOLU-MED500 | | ✓ | ✓ | |
| | 25 x 2ml act-o-vial/pack | RXSOLU-MEDROL | | ✓ | ✓ | |
| Sorb-A-Tox Suspension | 60ml syringe | RXSOAT-SYR | ✓ | | | |
| | 270ml | RXSOAT-270 | ✓ | | | |
| | gallon | RXSOAT-G | ✓ | | | |
| Spironolactone Tablets | 50mg, 100 tablets | RXSPIRO50-100 | | ✓ | | |
| | 25mg, 1000 tablets | RXSPIRO25-1000 | | ✓ | | |
| | 25mg, 100 tablets | RXSPIRO25-100 | | ✓ | | |
| Sterile Water for Injection |  | 10ml | RXWATER-10 | | ✓ | |
| | | bacteriostatic, 30ml | RXWATER-30 | | ✓ | |
| | | 50ml | RXWATER-50 | | ✓ | |
| | | 100ml bottle | RXWATER-100 | | ✓ | |
| | | 250ml for injection | RXWATER-250 | | ✓ | |
| | | 500ml glass bottle | RXWATER-500BOT | | ✓ | |
| | | 1 Liter | RXWATER-1L-INJ | | ✓ | |
| | | 500ml | RXWATER-500 | | ✓ | |
| Sterile Water for Irrigation | 1 Liter | RXWATER-1L | | ✓ | | |
| Strongid Paste | 20ml | RXSTRONGI-20 | ✓ | | ✓ | |
| Sucralfate (carafate) Tablets | 1gm, 100 tablets | RXCAR1-100 | | ✓ | | |
| | 1gm, 500 tablets | RXCAR1-500 | | ✓ | | |
| Sulf/Trim Suspension | 480ml | RXBAC-SUSP | | ✓ | | |
| Sulfa/Trimethoprim (SMZ) | Single Strength, 400/80mg, 100 tablets | RXSMZSS-100 | | ✓ | | |
| | Single Strength, 400/80mg, 500 tablets | RXSMZSS-500 | | ✓ | | |
| | Double Strength, 800/160mg, 100 tablets | RXSMZDS-100 | | ✓ | | |
| | Double Strength, 800/160mg, 500 tablets | RXSMZDS-500 | | ✓ | | |
| Sulfadimethoxine Oral Solution | 12.5%, gallon | RXSDM-GAL | ✓ | | | |

No returns on pharmaceuticals • Prices change frequently please call for current price • Shipping charges for refrigerated items are a flat charge based on your shipping zone. Customer accepts full responsibility for condition of products upon receipt. ❄ indicates Refrigerated Shipping • Pictures are for graphic purposes only, actual product may be different.

| Product | Size/Details | Product Code | Vet Label | RX | Brand | DEA |
|-------------------------------------|----------------------------|-----------------|-----------|----|-------|-----|
| Sulfasalazine | 500mg, 100 tablets | RXSUL500-100 | | ✓ | | |
| | 500mg, 500 tablets | RXSUL500-500 | | ✓ | | |
| SuperStat Vet | 6 discs/box | RXSTAT-6 | ✓ | ✓ | ✓ | |
| Swat Fly Repellent | 6oz | RXSWAT-60Z | ✓ | | ✓ | |
| Synotic Otic Solution | 8ml | RXSYN-8 | ✓ | ✓ | ✓ | |
| Talwin (CIV) Injection | 30mg/ml, 10ml | RXTALWIN | | ✓ | | CIV |
| Tamiflu | 75mg, 10 capsules | RXTAMIFLU-CAPS | | ✓ | ✓ | |
| | 12mg/ml, 25ml Suspension | RXTAMIFLU | | ✓ | ✓ | |
| Tapazole Tablets | 5mg, 100 tablets | RXTAPAZOLE | | ✓ | ✓ | |
| Tapeworm (Praziquantal) Tablets | Feline, 3 tablets/bottle | RXOTC8783 | ✓ | | | |
| | Canine, 5 tablets/bottle | RXOTC8785 | ✓ | | | |
| Tattoo Paste | Green, 5oz | RXTATTOO-G | ✓ | | | |
| Temaril-P Tablets | 100 tablets | RXTEMARIL-P100 | ✓ | ✓ | ✓ | |
| | 1000 tablets | RXTEMARILP-1000 | ✓ | ✓ | ✓ | |
| Terbinafine Tablets | 250mg, 100 tablets | RXTERBIN250-100 | | ✓ | | |
| Terbutaline Injection | 1mg, 10 x 1ml/bx | RXTERBUT-INJ | | ✓ | | |
| Terbutaline Sulfate | 5mg, 100 tablets | RXTERBUT5-100 | | ✓ | | |
| Terramycin Ophthalmic Ointment | 1/8oz tube | RXTERRA-1/8 | ✓ | | ✓ | |
| Tetracaine Ophthalmic Drops | 15ml | RXTETRA-15 | | ✓ | | |
| Tetracycline | 250mg, 100 capsules | RXTET250-100 | | ✓ | | |
| | 250mg, 1000 capsules | RXTET250-K | | ✓ | | |
| | 500mg, 100 capsules | RXTET500-100 | | ✓ | | |
| | 500mg, 1000 capsules | RXTET500-K | | ✓ | | |
| Theophylline ER Tablets | 100mg, 100 tablets | RXTHEO100-100 | | ✓ | | |
| | 200mg, 100 tablets | RXTHEO200-100 | | ✓ | | |
| Thiamine Injection | 200mg/ml, 100ml | RXTHIAMINE-100 | ✓ | ✓ | | |
| Timolol Maleate Ophthalmic Solution | 0.5%, 5ml | RXTIM.5-5 | | ✓ | | |
| | 0.5%, 10ml | RXTIMO.5-10 | | ✓ | | |
| | 0.5%, 15ml | RXTIMO.5-15 | | ✓ | | |
| | 0.25%, 5ml | RXTIM.25-10 | | ✓ | | |
| Tobramycin Injection | 40mg/ml, 25x2ml vials/pack | RXTOBRA-INJ40 | | ✓ | | |
| Tobramycin Ophthalmic Suspension | 5ml | RXTOBRA-5 | | ✓ | | |
| Tonekote Vitamin A, D, E | 16oz | RXVITADE-SUP | ✓ | | | |
| Tongue to Tail | 1oz | RXTONGUE-1 | ✓ | | | |
| Topiramate Tablets | 100mg, 500 tablets | RXTOPIR100-500 | | ✓ | | |
| Torbugesic (CIV) | 10mg/ml, 10ml | RXTORBUG10-10 | ✓ | ✓ | ✓ | CIV |
| Torbugesic-SA (CIV) | 2mg/ml, 10ml | RXTORBUG2-10 | ✓ | ✓ | ✓ | CIV |
| Torbutrol (CIV) Tablets | 1mg, 100 tablets | RXTORB1-100 | ✓ | ✓ | ✓ | CIV |
| | 5mg, 100 tablets | RXTORB5-100 | ✓ | ✓ | ✓ | CIV |
| Toxiban Suspension | 240ml | RXTOXIBAN | ✓ | | ✓ | |
| Toxiban with Sorbitol | 240ml | RXTOXIBAN-S | ✓ | | ✓ | |
| Tramadol Tablets | 50mg, 100 tablets | RXTRAM50-100 | | ✓ | | |
| | 50mg, 500 tablets | RXTRAM50-500 | | ✓ | | |
| Tresaderm * | 7.5ml | RXTRESA7.5 | ✓ | ✓ | ✓ | |
| | 15ml | RXTRESA15 | ✓ | ✓ | ✓ | |



No returns on pharmaceuticals • Prices change frequently please call for current price • Shipping charges for refrigerated items are a flat charge based on your shipping zone.

Customer accepts full responsibility for condition of products upon receipt. ❄️ Indicates Refrigerated Shipping • Pictures are for graphic purposes only, actual product may be different.

13822 WEST BOULTON BLVD. METTAWA, IL 60045

WWW.SHOPMEDVET.COM

Phone 800-544-7521

34

Fax 800-204-2177

| Product | Size/Details | Product Code | Vet Label | RX | Brand | DEA |
|--|---|-----------------|-----------|----|-------|------|
| Tretinoin Gel | 0.025%, 15gm | RXTRETINOIN | | ✓ | | |
| Tri-Hist Granules | 20oz | RXTRIHIST20 | ✓ | ✓ | ✓ | REP |
| Tri-Otic Ointment |  7.5gm tube | RXOTO-7.5 | ✓ | ✓ | ✓ | |
| | 15gm tube | RXOTO-15 | ✓ | ✓ | ✓ | |
| | 15gm bottles, 12/pack | RXOTO-15BX12 | ✓ | ✓ | ✓ | |
| | 25gm bottle | RXOTO-25 | ✓ | ✓ | ✓ | |
| | 215gm bottle | RXOTO-215 | ✓ | ✓ | ✓ | |
| Triamcinolone Cream | 0.1%, 80g | RXKENA-CREAM | | ✓ | | |
| Triamcinolone Ointment | 0.1%, 80g | RXKENA-OINT | | ✓ | | |
| Triamcinolone Tablets | 0.5mg, 1000 tablets | RXTRIAM0.5-1000 | ✓ | ✓ | | |
| | 1.5mg, 500 tablets | RXTRIAM1.5-500 | ✓ | ✓ | | |
| Triamterene with HCTZ | 37.5/25mg, 500 tablets | RXMAXZIDE | | ✓ | | |
| | 75/50mg, 500 tablets | RXMAXZIDE75 | | ✓ | | |
| Triforce Flea and Tick Preventive | Feline, 2.2-5lb, 3 month | RXTRIFORCE-SM | ✓ | | ✓ | |
| | Feline, greater than 5lbs, 3 month | RXTRIFORCE-LG | ✓ | | ✓ | |
| Triple Antibiotic Ointment | 15gm | RXTRIP-OI15 | | | | |
| | 30gm | RXTRIP-OI30 | | | | |
| Triple Antibiotic Plus Pain Reliever | 30gm | RXTRIP-PLUS | | | | |
| TrizEDTA Aqueous Flush | 4oz | RXTRIED-FL | ✓ | | ✓ | |
| TrizEDTA Crystals | 4oz | RXTRIED-CR | ✓ | | ✓ | |
| Tropicamide Ophthalmic Suspension | 1%, 15ml | RXTROPICAMIDE15 | | ✓ | | |
| Tumil-K |  4oz powder | RXTUMIL-POW | ✓ | ✓ | ✓ | |
| | 2meq, 100 tablets | RXTUMIL-K | ✓ | ✓ | ✓ | |
| | 5oz gel | RXTUMIL-GEL | ✓ | ✓ | ✓ | |
| Tylan Injection | 200mg/ml, 250ml | RXTYLAN200-250 | ✓ | ✓ | ✓ | |
| Tylan Soluble | 100gm | RXTYLAN100GM | ✓ | ✓ | ✓ | |
| Tylenol 3 with Codeine (CIII) Tablets | 30mg, 1000 tablets | RXTYLENOL/CODEI | | ✓ | | CIII |
| UAA Gel | 300ml | RXUAA-8 | ✓ | | | |
| | 60ml Dial-a-Dose syringe | RXUAA-SYR | ✓ | | | |
| Ultra Drench 2000 | 32 oz. | RXDRENCH-32 | ✓ | | | |
| Unasyn | 1.5gm vial, 10 vials/pack | RXUNASYN | | ✓ | ✓ | |
| Uniprim Powder | 67/333mg, 37.5gm packet | RXUNIPRIM | ✓ | ✓ | ✓ | |
| Urine-Off |  for Dogs 500ml, veterinary strength | RXURINE-OFF | | | ✓ | |
| |  for Cats 500ml, veterinary strength | RXURINE-OFF-CAT | | | ✓ | |
| Uroze Tablets |  200mg, 500 tablets | RXURO200-500 | ✓ | ✓ | ✓ | |
| | 400mg, 500 tablets | RXURO400-500 | ✓ | ✓ | ✓ | |
| Ursodiol Capsules | 300mg, 100 capsules | RXURSODIOL | | ✓ | | |
| Vaccine-East/West Encephalitis + Tetanus * | Equine, 1 dose, Equiloid Innovator | RXV-EQ-EWE-TET | ✓ | | ✓ | |
| Vaccine-Equine Influenza/Rhino * | Equine, 1 dose, Fluvac Innovator EHV 4/1 | RXV-EQ-INF/RHI1 | ✓ | | ✓ | |
| Vaccine-Fort Dodge-DAPP * | Canine, 25x1 dose/pack, Duramune Max 5 | RXV-DAPP-FD1 | ✓ | | ✓ | |
| Vaccine-Fort Dodge-DAPP + CVK * | Canine, 25x1 dose/pack, Duramune Max 5 + CVK | RXV-DAPPC-FD1 | ✓ | | ✓ | |
| Vaccine-Fort Dodge-DAPP + CVK/4L * | Canine, 25x1 dose/pack, Duramune Max 5 + CVK/4L | RXV-DAPPC4L-FD1 | ✓ | | ✓ | |
| Vaccine-Fort Dodge-DAPP+4L * | Canine, 25 x 1 dose/pack, Duramune Max 5/4L | RXV-DAPP4L-FD1 | ✓ | | ✓ | |

No returns on pharmaceuticals • Prices change frequently please call for current price • Shipping charges for refrigerated items are a flat charge based on your shipping zone. Customer accepts full responsibility for condition of products upon receipt. * Indicates Refrigerated Shipping • Pictures are for graphic purposes only, actual product may be different.

| Product | Size/Details | Product Code | Vet Label | RX | Brand | DEA |
|---|--|-----------------|-----------|----|-------|-----|
| Vaccine-Fort Dodge-East/West Encephalitis + Tetanus * | Equine, 10 dose tank, Equiloid Innovator | RKV-EQ-EWT10 | ✓ | | ✓ | |
| Vaccine-Fort Dodge-Eastern/Western Encephalitis, Influenza-Tetanus * | Equine, 10 dose tank, Fluvac Innovator 4 | RKV-FLUVAC4-10 | ✓ | | ✓ | |
| Vaccine-Fort Dodge-Flu * | Equine, 10 dose tank, Fluvac Innovator | RKV-FLUVAC1-10 | ✓ | | ✓ | |
| Vaccine-Fort Dodge-Influenza/Rhino * | Equine, 10 dose tank, Fluvac Innovator EHV-4/1 | RKV-FLU-EHV4-10 | ✓ | | ✓ | |
| Vaccine-Fort Dodge-Leptospirosis (4 serovar) * | canine, 25x1 dose/tray, LeptoVax 4 | RKV-LEPT04-FD1 | ✓ | | ✓ | |
| Vaccine-Fort Dodge-Lyme * | canine, 50x1 dose/pack, LymeVax | RKV-LYME-FD1 | ✓ | | ✓ | |
| Vaccine-Fort Dodge-Parvovirus + Coronavirus * | Canine, 10 dose tank, Duramune Max PC | RKV-PC-FD10 | ✓ | | ✓ | |
| Vaccine-Fort Dodge-Rabies 1 year * | Canine, Feline, 10 dose tank, Rabvac 1 | RKV-RAB1FD10 | ✓ | ✓ | ✓ | |
| | Canine, Feline 50x1dose/pack, Rabvac 1 TP | RKV-RAB1Y-FD1 | ✓ | ✓ | ✓ | |
| Vaccine-Fort Dodge-Rabies 3 year * | Canine, Feline, Equine, 50x1dose/pack, Rabvac 3 TP | RKV-RAB3Y-FD1 | ✓ | ✓ | ✓ | |
| Vaccine-Fort Dodge-Rabies 3 Year * | Canine, Feline, Equine, 10 dose tank, Rabvac 3 | RKV-RAB3Y-FD10 | ✓ | ✓ | ✓ | |
| Vaccine-Fort Dodge-RCCP * | Feline, 25x1dose/pack, Fel-O-Guard Plus IV | RKV-RCCP-FD1 | ✓ | | ✓ | |
| Vaccine-Fort Dodge-RCP * | Feline, 50x1dose/pack, Felovax PCT | RKV-RCP-FD1 | ✓ | | ✓ | |
| Vaccine-Fort Dodge-Strep Intranasal * | Equine, 10x1dose/pack, Pinnacle IN | RKV-EQ-STREP-FD | ✓ | | ✓ | |
| Vaccine-Fort Dodge-Tetanus Antitoxin * | Equine, 10x1 dose/pack | RKV-TET-ANTI-1 | ✓ | | ✓ | |
| Vaccine-Fort Dodge-West Nile + Eastern/Western Encephalitis + Tetanus * | Equine, 10 dose tank, West Nile Innovator + EWT | RKV-NILE-EWT | ✓ | | ✓ | |
| Vaccine-Fort Dodge-Tetanus Toxoid * | Equine, 10 dose tank | RKV-TET-TOX-10 | ✓ | | ✓ | |
| Vaccine-Fort Dodge-West Nile * | Equine, 10 dose tank, West Nile Innovator | RKV-WESTNILE10 | ✓ | | ✓ | |
| Vaccine-Heska-RC * | feline, intranasal, 20x1, FVRC | RKV-RC-HESK1 | ✓ | | ✓ | |
| Vaccine-Intervet-Bordetella * | feline, 25x1 dose/pack, Protex BB | RKV-BORD-IN1 | ✓ | | ✓ | |
| Vaccine-Intervet-DAPP * | Canine, 25x1dose/pack, Progard 5 | RKV-DAPP-INT1 | ✓ | | ✓ | |
| Vaccine-Intervet-Distemper and Parvo * | Canine, 25x1 dose/pack, Proguard D + PV | RKV-DPV-INV1 | ✓ | | ✓ | |
| Vaccine-Intervet-Influenza Intranasal * | Equine, 10 x 1dose/pack, Flu-Avert | RKV-EQ-FLUAVERT | ✓ | | ✓ | |
| Vaccine-Merial-Potomac Fever * | equine, 5x1ds/pk, Potomac Vac | RKV-EQPOT-MER5 | ✓ | | ✓ | |
| Vaccine-Schering-Bordetella Intranasal * | Canine, 25x1dose/pack, Intra-Trac 3 | RKV-BORD3-SP1 | ✓ | | ✓ | |
| | Canine, 25x1dose/pack, Intra-Trac II | RKV-BORD-SP1 | ✓ | | ✓ | |
| Vaccine-Schering-DAPP * | Canine, 25x1dose/pack, Galaxy DA2PPV | RKV-DAPP-SP1 | ✓ | | ✓ | |
| Vaccine-Schering-DAPPC * | Canine, 25x1 dose/pack, Galaxy DA2PPV + CV | RKV-DAPPC-SP1 | ✓ | | ✓ | |
| Vaccine-Schering-DAPPL * | Canine, 25x1dose/pack, Galaxy DA2PPVL | RKV-DAPPL-SP1 | ✓ | | ✓ | |
| Vaccine-Schering-DAPPL+CV * | Canine, 25x1dose/pack, Galaxy DA2PPVL + CV | RKV-DAPPLC-SP1 | ✓ | | ✓ | |
| Vaccine-Schering-Distemper Only * | Canine, 25x1dose/pack, Galaxy D | RKV-DISTEMP-SP1 | ✓ | | ✓ | |
| Vaccine-Schering-Feline Leukemia * | Feline, 25x1dose/pack, Fevaxyn FELV | RKV-FELV-SP1 | ✓ | | ✓ | |
| Vaccine-Schering-Parvo * | Canine, 10 dose tank, Galaxy PV | RKV-PARVO-SP10 | ✓ | | ✓ | |
| | Canine, 25x1 dose/pack, Galaxy PV | RKV-PARVO-SP1 | ✓ | | ✓ | |
| Vaccine-Schering-Rabies 1 year * | Canine, Feline, 10 dose tank, Rabdomun 1 | RKV-RAB1Y-SP10 | ✓ | ✓ | ✓ | |

No returns on pharmaceuticals • Prices change frequently please call for current price • Shipping charges for refrigerated items are a flat charge based on your shipping zone. Customer accepts full responsibility for condition of products upon receipt. * Indicates Refrigerated Shipping • Pictures are for graphic purposes only, actual product may be different.

| Product | Size/Details | Product Code | Vet Label | RX | Brand | DEA |
|--|--|-----------------|-----------|----|-------|-----|
| Vaccine-Schering-Rabies 3 Year * | Canine, Feline, 10 dose tank, Rabdomun | R0V-RAB3Y-SP10 | ✓ | ✓ | ✓ | |
| | Canine, Feline, 50x1 dose/pack, Rabdomun | R0V-RAB3Y-SP1 | ✓ | ✓ | ✓ | |
| Vaccine-Schering-RCCP * | Feline, 25x1dose/pack, Eclipse 4 | R0V-RCCP-SP1 | ✓ | | ✓ | |
| Vaccine-Schering-RCCP + FELV * | Feline, 25x1dose/pack, Eclipse 4 + FELV | R0V-RCCPFL-SP1 | ✓ | | ✓ | |
| Vaccine-Schering-RCP * | Feline, 25x1dose/pack, Eclipse 3 | R0V-RCP-SP1 | ✓ | | ✓ | |
| Vaccine-Schering-RCP+FELV * | feline, 25x1 dose/pack, Galaxy 3 + FELV | R0V-RCPFL-SP1 | ✓ | | ✓ | |
| Vancomycin Hydrochloride Injection | 500mg | R0VANCO500INJ | | ✓ | | |
| Vasopressin Injection | 20 units/ml, 25x1ml/box | R0VASOPRESSIN | | ✓ | | |
| Ventipulmin Syrup | 100ml | R0VENTI-SY | ✓ | ✓ | ✓ | |
| Verapamil ER | 180mg, 100 tablets | R0VERAP180ER | | ✓ | | |
| | 240mg, 100 tablets | R0VERA240-100 | | ✓ | | |
| | 240mg, 500 tablets | R0VERA240-500 | | ✓ | | |
| Verruca-Freeze | starter kit: 60-70 freezes with cones and buds | R0VERRUCA | | ✓ | ✓ | |
| | Refill Canister: 60-70 freezes | R0VERRUCA-REF | | ✓ | ✓ | |
| | mini kit: 30-35 freezes with cones and buds | R0VERRUCA-MINI | | ✓ | ✓ | |
| | mini replacement canister: 30-35 freezes | R0VERRUCA-MINIR | | ✓ | ✓ | |
| | Soft tip cones, 5/pk | R0VERRUCA-CONES | | ✓ | ✓ | |
| | Cryo Buds small, 2mm, 30/pk | R0VERRUCA-S | | ✓ | ✓ | |
| | Cryo Buds medium 4-6mm, 30/pk | R0VERRUCA-M | | ✓ | ✓ | |
| Cryo Buds large, 8-10mm, 30/pk | R0VERRUCA-L | | ✓ | ✓ | | |
| Vetalog Injection | 2mg/ml, 25ml | R0VETLOG-INJ | ✓ | ✓ | ✓ | |
| | 2mg/ml, 100ml | R0VETLOG-100 | ✓ | ✓ | ✓ | |
| Veterinary Surfactant | 1 gallon | R0LAX-GAL | ✓ | | | |
| Vetisulid Powder | 54g | R0VETISULID | ✓ | | ✓ | |
| Vetmedin | 1.25mg, 50 tablets | R0VETMEDIN | ✓ | ✓ | ✓ | |
| | 5mg, 50 tablets | R0VETMEDIN5 | ✓ | ✓ | ✓ | |
| Vetoryl (Trilostane) | 10mg, 30 capsules | R0VETORYL10 | ✓ | ✓ | ✓ | |
| | 30mg, 30 capsules | R0VETORYL30 | ✓ | ✓ | ✓ | |
| | 60mg, 30 capsules | R0VETORYL60 | ✓ | ✓ | ✓ | |
| Vetprofen Tablets | 75mg, 240 caplets | R0VETPROFEN75 | ✓ | ✓ | ✓ | |
| | 100mg, 240 tablets | R0VETPROFEN | ✓ | ✓ | ✓ | |
| Vetrachloracin (Chloramphenicol) Ophthalmic Ointment | 3.5gm | R0VET-CHL | ✓ | ✓ | ✓ | |
| Viagra Tablets | 50mg, 30 tablets | R0VIAGRA50-30 | | ✓ | ✓ | |
| Vincristine Injection * | 1mg/ml, 1ml | R0VINCRIS-1 | | ✓ | | |
| Viokase Tablets | 425mg, 500 tablets | R0VIOKASE | ✓ | ✓ | ✓ | |
| VIP Fly Repellent Ointment | 2oz | R0VIP-FLY-OINT | ✓ | | | |
| Viralys Powder | 100gm | R0VIRALYS-100 | ✓ | ✓ | ✓ | |
| | 600gm | R0VIRALYS-600 | ✓ | ✓ | ✓ | |
| Vita Tabs for Dogs & Cats | 50 tablets | R0VITATAB-50 | ✓ | | ✓ | |
| Vitamin B Complex | 100ml vet label | R0VITB-100 | ✓ | ✓ | | |
| | 250ml vet label | R0VITB-250 | ✓ | ✓ | | |
| Vitamin B12 Injection | 1000mcg, 1ml, 25/pack | R0VITB12-1ML | | ✓ | | |
| | 1000mcg, 30ml | R0VITB12-INJ | | ✓ | | |
| | 1000mcg, 100ml vet label | R0VITB12-100 | ✓ | ✓ | | |
| | 1000mcg, 250ml vet label | R0VITB12-250 | ✓ | ✓ | | |
| | 3000mcg, 100ml vet label | R0VITB12-3K-100 | ✓ | ✓ | | |
| | 5000mcg, 100ml vet label | R0VITB12-5K-100 | ✓ | ✓ | | |

No returns on pharmaceuticals • Prices change frequently please call for current price • Shipping charges for refrigerated items are a flat charge based on your shipping zone. Customer accepts full responsibility for condition of products upon receipt. ❄️ indicates Refrigerated Shipping • Pictures are for graphic purposes only, actual product may be different.

| Product | Size/Details | Product Code | Vet Label | RX | Brand | DEA |
|-------------------------------------|---------------------------|-----------------|-----------|----|-------|-----|
| Vitamin C Injection | 250ml | RXVTC-250 | ✓ | ✓ | | |
| Vitamin K Injection | 10mg/ml, 100ml | RXVITKINJ100 | ✓ | ✓ | | |
| Vitamin K1 Chewables | 25mg, 50 chewable tablets | RXVITKCH-25 | ✓ | ✓ | | |
| | 50mg, 50 chewable tablets | RXVITKCH-50 | ✓ | ✓ | | |
| Vitamin K1 Capsules | 25mg, 50 capsules | RXVITK-50 | ✓ | ✓ | | |
| Warfarin Sodium Tablets | 5mg, 100 tablets | RXCDOUM5-100 | | ✓ | | |
| Welactin For Cats | 60 soft gels | RXWELACTIN-C | ✓ | ✓ | ✓ | |
| Welactin For Dogs | 120 soft gels | RXWELACTIN-D | ✓ | ✓ | ✓ | |
| Witness FeLV Test Kit | 10 tests/kit | RXWITFELV-10 | ✓ | | ✓ | |
| Witness Heartworm Antigen Test | 25 tests/box | RXWITHW-25 | ✓ | | ✓ | |
| Witness Parvo Test | 10 tests/box | RXWITPARVO-10 | ✓ | | ✓ | |
| Witness Relaxin Test | 5 tests/box | RXWIT-RELAX | ✓ | | ✓ | |
| Xalatan Ophthalmic Solution * | 2.5ml | RXXALATAN-2.5 | | ✓ | ✓ | |
| Xenodine (Iodine) | 12oz bottle | RXXENODINE | ✓ | | | |
| Xylazine (Anased) Injection | 20mg/ml, 20ml | RXANASED-20 | ✓ | ✓ | ✓ | |
| Xylazine Injection | 100mg/ml, 50ml | RXXYLAZINE | ✓ | ✓ | | |
| Xylocaine Brand Injection | 2%, 50ml | RXXYLOCAINE2-50 | | ✓ | ✓ | |
| Yohimbine Injectable | 2mg/ml, 20ml | RXXYOHIMBINE | ✓ | ✓ | ✓ | |
| Yuk-2e Anti-Lick Gel | 0.5oz | RXXYUK-0.5 | ✓ | | ✓ | |
| Zeniquin Tablets | 25mg, 100 tablets | RXZEN25-100 | ✓ | ✓ | ✓ | |
| | 50mg, 100 tablets | RXZEN50-100 | ✓ | ✓ | ✓ | |
| | 100mg, 50 tablets | RXZEN100-50 | ✓ | ✓ | ✓ | |
| Zentoni Tablets | 100mg, 30 tablets/box | RXZEN100-30 | ✓ | ✓ | ✓ | |
| | 200mg, 30 tablets/box | RXZEN200-30 | ✓ | ✓ | ✓ | |
| Zinc Sulfate Fecal Flotation Medium | 1 gallon | RXZVA-GAL | ✓ | | | |
| Zolpidem Tartrate (CIV) | 10mg, 100 tablets | RXZOLP10-100 | | ✓ | | CIV |
| Zubrin for Dogs | 50mg, 100 tablets | RXZUB-50 | ✓ | ✓ | ✓ | |
| | 100mg, 30 tablets | RXZUB-100 | ✓ | ✓ | ✓ | |
| | 200mg, 30 tablets | RXZUB200-30 | ✓ | ✓ | ✓ | |
| | 200mg, 90 tablets | RXZUB-200 | ✓ | ✓ | ✓ | |
| Zymox Ear Cleanser | 4oz | RXZYM-4OZ | ✓ | | ✓ | |
| Zymox Medicated Rinse | 12oz | RXZYMRIN-12 | ✓ | | ✓ | |
| Zymox Medicated Shampoo | 12oz | RXZYMSHA-12 | ✓ | | ✓ | |
| Zymox Otic | 1.25oz | RXZYMW/O-125 | ✓ | | ✓ | |
| Zymox Otic with HCL | 1.25oz | RXZYM-1.25 | ✓ | | ✓ | |
| Zymox Topical Cream | 1oz | RXZYMTCRW/O | ✓ | | ✓ | |
| Zymox Topical Cream with HCL | 1oz | RXZYMTCR-1 | ✓ | | ✓ | |
| Zymox Topical Spray | 2.5oz | RXZYMTSPW/O | ✓ | | ✓ | |
| Zymox Topical Spray with HCL | 2.5oz | RXZYMTSP-2 | ✓ | | ✓ | |
| Zymox Topical Wipes | 30 wipes/pk | RXZYMTWW/O | ✓ | | ✓ | |
| Zymox Topical Wipes with HCL | 30 wipes/pk | RXZYMTWI-25 | ✓ | | ✓ | |

No returns on pharmaceuticals • Prices change frequently please call for current price • Shipping charges for refrigerated items are a flat charge based on your shipping zone. Customer accepts full responsibility for condition of products upon receipt. * Indicates Refrigerated Shipping • Pictures are for graphic purposes only, actual product may be different.

PHARMACEUTICAL POLICIES

Controlled Substances:

License is required. Controlled Substances will be shipped to the address listed on the DEA license only. For Schedule 2 & 2n Controlled Substances, see DEA 222 form instructions below.

Cold Shipping:

Shipping charges for refrigerated items are a flat charge based on Shipping Zone.

Fluids Freight:

Fluids are limited to 2 liters under normal freight policy. Additional fluids are billed at actual freight.

Hazardous Material Shipping:

Isoflurane, Sevoflurane, Ethyl Chloride and any other products classified as Hazardous Materials/Dangerous Goods will be shipped exclusively via ground service.

Return Policy:

Customer accepts full responsibility for condition of products upon receipt. No returns on Pharmaceuticals

Price Change Policy:

Prices change frequently please call for current price

Pedigree

To obtain Pedigree Information for purchased pharmaceuticals visit www.shopmedvet.com/pedigree

*Note we only sell pharmaceuticals to licensed medical professionals, we DO NOT fill prescriptions.

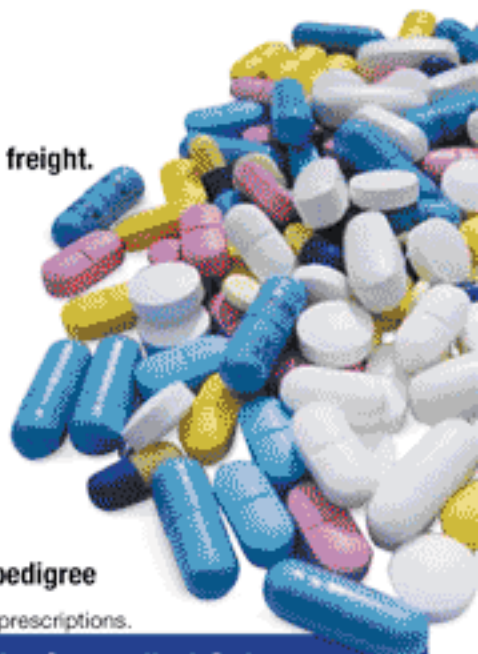

Instructions for completing a: DEA 222 form to order Schedule 2 and 2n Controlled Substances

Fill in Date

| See Reverse of PURCHASER'S Copy for Instructions | | No order form may be issued for Schedule I and II Substances unless a completed application form has been received. (21 CFR 1301.04) | | OMB APPROVAL No. 1517-0018 | | |
|--|-----------------|--|---|---|-----------------|--------------|
| TO: (Name of Supplier) MED-VET INTERNATIONAL | | | STREET ADDRESS 13822 W BOULTON BLVD | | | |
| CITY and STATE: METTAWA, IL | | DATE XX/XX/XX | | TO BE FILLED IN BY SUPPLIER SUPPLIER'S DEA REGISTRATION No. | | |
| TO BE FILLED IN BY PURCHASER | | | | | | |
| Line No. | No. of Packages | Size of Package | Name of Item | National Drug Code | Package Shipped | Date Shipped |
| 1 | 1 | 5 | Fentanyl Transdermal Patch 25mcg/hr | | | |
| 2 | 2 | 250cc | Fetal Plus, Sodium Pentobarbital, 6 grain/ml | | | |
| 3 | 5 | 20cc | Hydromorphone 2mg/ml | | | |
| SAMPLE | | | | | | |
| 3 ← LAST LINE COMPLETED (MUST BE 10 OR LESS) | | | | | | |
| Date Issued 01/28/2010 | | DEA Registration No. BA***** | | Name and Address of Registrant ABC Veterinary Clinic 123 Main Street Anywhere, USA 123456 | | |
| Schedules 2, 2N, 3, 3N, 4, 5 | | Registered as a Practitioner | | No. of this Order Form 123456789 | | |
| DEA Form-222 (MAR 2000) | | U.S. OFFICIAL ORDER FORMS - SCHEDULES I & II | | 12***** | | |
| SUPPLIER'S Copy 1 | | | | | | |

Signature required or form is invalid

Address on Form
MED-VET INTERNATIONAL
13822 W Boulton Blvd
Mettawa, IL 60045

SAVE THIS WITH YOUR 222 ORDER FORMS FOR FUTURE REFERENCE

Address on Envelope
MED-VET INTERNATIONAL
13822 W Boulton Blvd
Mettawa, IL 60045



← Last Line Completed: Enter only the number of lines used. In the example above, the last line completed would be 3.

Listed below is detailed information to help you in filling out the DEA form 222 for class 2 and 2n drugs. This is only to be used in ordering class 2 and 2n drugs.

- Product will be shipped to the address on the dea license only
- Form 222 can contain no corrections or strike-over marks
- Use the following Med-Vet International address on the request form:
13822 W Boulton Blvd, Mettawa, IL 60045
- Please keep customer copy (blue copy) and mail remaining copies for processing to: **13822 W Boulton Blvd, Mettawa, IL 60045**
- Be sure to refer to the back of the blue copy of your 222 form for complete instructions

Suture and Skin Closure

Monofilament Absorbable Suture



PDO II-MONOFILAMENT ABSORBABLE SUTURE

COMPARE TO
PDSII®

- Excellent Knot Security: Designed for secure knotting
- Smooth Monofilament: Minimizes tissue trauma by allowing easy passage
- Gradual Absorption Rate: Absorbs between 180-220 days after placement
- Excellent Pliability: Makes suturing easier by handling like a braided suture
- Excellent Holding Strength: Retains 50% of tensile strength for up to 6 weeks after procedure

TAPER POINT NEEDLES

| Item# | Size | Needle | Qty | Length |
|---------|------|--------|-------|--------|
| MV-Z310 | 4-0 | NSH-1 | 12/bx | 30" |
| MV-Z315 | 4-0 | NSH | 12/bx | 30" |
| MV-Z311 | 3-0 | NSH-1 | 12/bx | 30" |
| MV-Z316 | 3-0 | NSH | 12/bx | 30" |
| MV-Z332 | 3-0 | NCT-2 | 12/bx | 30" |
| MV-Z317 | 2-0 | NSH | 12/bx | 30" |
| MV-Z333 | 2-0 | NCT-2 | 12/bx | 30" |
| MV-Z339 | 2-0 | NCT-1 | 12/bx | 30" |
| MV-Z334 | 0 | NCT-2 | 12/bx | 30" |
| MV-Z340 | 0 | NCT-1 | 12/bx | 30" |
| MV-Z341 | 1 | NCT-1 | 12/bx | 30" |

REVERSE CUTTING NEEDLES

| Item# | Size | Needle | Qty | Length |
|---------|------|--------|-------|--------|
| MV-Z397 | 4-0 | NFS-2 | 12/bx | 30" |
| MV-Z398 | 3-0 | NFS-2 | 12/bx | 30" |
| MV-Z452 | 3-0 | NFS-1 | 12/bx | 30" |
| MV-Z451 | 2-0 | NFS-1 | 12/bx | 30" |
| MV-Z466 | 2-0 | NCP-1 | 12/bx | 30" |
| MV-Z587 | 0 | NFSL | 12/bx | 30" |
| MV-Z467 | 0 | NCP-1 | 12/bx | 30" |
| MV-Z468 | 1 | NCP-1 | 12/bx | 30" |

\$34⁰⁰
/Dz

(VET USE ONLY)

PDO CASSETTE SUTURE

- Composition: Polydioxanone
- Absorption Type: Hydrolysis
- Structure: Monofilament
- Thread Color: Violet

| Item# | Size | Length | Price | |
|-------|----------|--------|-------|----------|
| PD30 | Cassette | 3-0 | 15M | \$39.60* |
| PD20 | Cassette | 2-0 | 15M | \$45.60* |
| PD02 | Cassette | 2 | 15M | \$67.20* |
| PD01 | Cassette | 1 | 15M | \$57.60* |
| PD10 | Cassette | 0 | 15M | \$54.40* |



(VET USE ONLY)

Starting at
\$39⁶⁰/ea

Oasis

NEEDLE CHART Super Sharp Point Siliconized Needles

1/2 CIRCLE TAPER POINT

| Needle | Size |
|--------|------|
| NSH-1 | 22mm |
| NSH | 26mm |
| NCT-2 | 27mm |
| NCT-1 | 36mm |



Taper Point

3/8 CIRCLE REVERSE CUTTING

| Needle | Size |
|--------|------|
| NFS-2 | 19mm |
| NFS-1 | 24mm |
| NFS | 26mm |
| NFSL | 30mm |

1/2 CIRCLE REVERSE CUTTING POINT

| Needle | Size |
|--------|------|
| NCP-2 | 27mm |
| NCP-1 | 36mm |
| NX-1 | 23mm |



Reverse Cutting

13822 WEST BOULTON BLVD. METTAWA, IL 60045

WWW.SHOPMEDVET.COM

Phone 800-544-7521

40

Fax 800-204-2177

Suture and Skin Closure

Braided Absorbable Suture

PGA-BRAIDED ABSORBABLE SUTURE



- **Extremely Strong:** Retains 60%-70% tensile strength at 14 days
- **Excellent Knot Security:** Precision braided construction designed to provide secure knotting
- **Extremely Smooth:** Unique calcium stearate coating ensures smooth tissue passage with minimal trauma to tissue
- **Rapid Absorption Rate:** Absorbs between 60-90 days after placement
- **Excellent Pliability:** Braided construction allows for excellent handling properties



COMPARE TO
VICRYL®

\$28⁰⁰
/dz

TAPER POINT NEEDLES

| Item# | Size | Needle | Qty | Length |
|---------|------|--------|-------|--------|
| MV-J310 | 4-0 | NSH-1 | 12/bx | 30 |
| MV-J315 | 4-0 | NSH | 12/bx | 30 |
| MV-J332 | 3-0 | NCT-2 | 12/bx | 30 |
| MV-J338 | 3-0 | NCT-1 | 12/bx | 30 |
| MV-J311 | 3-0 | NSH-1 | 12/bx | 30 |
| MV-J316 | 3-0 | NSH | 12/bx | 30 |
| MV-J333 | 2-0 | NCT-2 | 12/bx | 30 |
| MV-J339 | 2-0 | NCT-1 | 12/bx | 30 |
| MV-J317 | 2-0 | NSH | 12/bx | 30 |
| MV-J334 | 0 | NCT-2 | 12/bx | 30 |
| MV-J340 | 0 | NCT-1 | 12/bx | 30 |
| MV-J318 | 0 | NSH | 12/bx | 30 |
| MV-J341 | 1 | NCT-1 | 12/bx | 30 |

REVERSE CUTTING NEEDLES

| Item# | Size | Needle | Qty | Length |
|---------|------|--------|-------|--------|
| MV-J397 | 4-0 | NFS-2 | 12/bx | 30 |
| MV-J451 | 4-0 | NFS-1 | 12/bx | 30 |
| MV-J398 | 3-0 | NFS-2 | 12/bx | 30 |
| MV-J452 | 3-0 | NFS-1 | 12/bx | 30 |
| MV-J460 | 3-0 | NX-1 | 12/bx | 30 |
| MV-J466 | 2-0 | NCP-1 | 12/bx | 30 |
| MV-J453 | 2-0 | NFS-1 | 12/bx | 30 |
| MV-J461 | 2-0 | NX-1 | 12/bx | 30 |
| MV-J587 | 0 | NFSL | 12/bx | 30 |
| MV-J467 | 0 | NCP-1 | 12/bx | 30 |
| MV-J468 | 1 | NCP-1 | 12/bx | 30 |

PGA SUTURE CASSETTE



- **Composition:** Polyglycolic Acid
- **Absorption Type:** Hydrolysis
- **Structure:** Braided
- **Thread Color:** Violet
- **Coating:** Calcium Stearate

\$29⁹⁵/ea
Starting at

| Item# | Size | Length | Price | |
|-------|----------|--------|-------|---------|
| PG30 | Cassette | 3-0 | 15M | \$29.95 |
| PG20 | Cassette | 2-0 | 15M | \$34.95 |
| PG10 | Cassette | 0 | 15M | \$41.95 |
| PG01 | Cassette | 1 | 15M | \$43.95 |
| PG02 | Cassette | 2 | 15M | \$61.95 |
| PG03 | Cassette | 3 | 15M | \$69.95 |

(VET USE ONLY)

NEEDLE CHART Super Sharp Point Siliconized Needles



1/2 CIRCLE TAPER POINT

| Needle | Size |
|--------|------|
| NSH-1 | 22mm |
| NSH | 26mm |
| NCT-2 | 27mm |
| NCT-1 | 36mm |



Taper Point

3/8 CIRCLE REVERSE CUTTING

| Needle | Size |
|--------|------|
| NFS-2 | 19mm |
| NFS-1 | 24mm |
| NFS | 26mm |
| NFSL | 30mm |

1/2 CIRCLE REVERSE CUTTING POINT

| Needle | Size |
|--------|------|
| NCP-2 | 27mm |
| NCP-1 | 36mm |
| NX-1 | 23mm |



Reverse Cutting

13822 WEST BOULTON BLVD. METTAWA, IL 60045

WWW.SHOPMEDVET.COM

Phone 800-544-7521

41

Fax 800-204-2177

Suture and Skin Closure

Monofyl & Nylon Suture



MONOFYL ABSORBABLE SUTURE



(VET USE ONLY)



- MONOFYL is a monofilament synthetic absorbable surgical suture prepared from a copolymer of glycolide and epsilon-caprolactone. The chemical composition is similar to Ethicon Monocryl.
- MONOFYL retains approximately 50%-60% of its original strength 7 days post implantation. Absorption of MONOFYL absorbable synthetic is essentially complete between 91 and 119 days.

COMPARE TO
MONOCRYL®



\$35⁰⁰
/dz

REVERSE CUTTING NEEDLES

| Item# | Size | Needle | Qty/box | Length |
|---------|------|--------|---------|--------|
| MV-Y922 | 4-0 | NFS-2 | 12/box | 30 |
| MV-Y923 | 3-0 | NFS-2 | 12/box | 30 |
| MV-Y942 | 3-0 | NFS-1 | 12/box | 30 |
| MV-Y943 | 2-0 | NFS-1 | 12/box | 30 |
| MV-Y987 | 0 | NFSL | 12/box | 30 |
| MV-Y967 | 0 | NCP-1 | 12/box | 30 |

TAPER POINT NEEDLES

| Item# | Size | Needle | Qty/box | Length |
|---------|------|--------|---------|--------|
| MV-Y344 | 3-0 | NCT-1 | 12/box | 30 |
| MV-Y345 | 2-0 | NCT-1 | 12/box | 30 |
| MV-Y346 | 0 | NCT-1 | 12/box | 30 |

NYLON SUTURE

COMPARE TO

ETHILON®

- **Extremely Strong:** High tensile strength suture that exceeds USP requirements
- **Excellent Knot Security:** Designed for secure knotting
- **Extremely Smooth:** surface allows for easy passage through tissue

REVERSE CUTTING NEEDLES

| Item# | Size | Needle | Qty | Length |
|---------|------|--------|--------|--------|
| MV-661 | 5-0 | NFS-2 | 12/box | 30" |
| MV-662 | 4-0 | NFS-2 | 12/box | 30" |
| MV-1629 | 4-0 | NFS-1 | 12/box | 30" |
| MV-663 | 3-0 | NFS-1 | 12/box | 30" |
| MV-664 | 2-0 | NFS | 12/box | 30" |
| MV-N666 | 1 | NFSL | 12/box | 30" |
| MV-N665 | 0 | NFSL | 12/box | 30" |

\$17⁴⁸
/dozen



NYLON SUTURE CASSETTE

- **Composition:** Polyamide
- **Absorption Type:** Non-absorbable
- **Structure:** Monofilament
- **Thread Color:** Black

| Item# | Size | Length | Price |
|-------|--------------|--------|---------|
| MF30 | Cassette 3-0 | 100M | \$23.52 |
| MF20 | Cassette 2-0 | 100M | \$29.12 |
| MF02 | Cassette 2 | 50M | \$27.04 |
| MF01 | Cassette 1 | 75M | \$29.76 |
| MF10 | Cassette 0 | 75M | \$29.76 |

Starting at

\$23⁵²

Vet Use Only

13822 WEST BOULTON BLVD. METTAWA, IL 60045

WWW.SHOPMEDVET.COM

Phone 800-544-7521

42

Fax 800-204-2177

Chromic Gut Suture



CHROMIC GUT SUTURE

- **Extremely Strong:** Very high tensile strength
- **Excellent Knot Security:** Designed to provide secure knotting
- **Excellent Pliability & Flexibility:** Designed to be more pliable & flexible



TAPER POINT NEEDLES

| Item# | Size | Needle | Qty | Length |
|---------|------|-------------|-----|--------|
| MV-G121 | 4-0 | NSH 12/bx | 12 | 30" |
| MV-810 | 3-0 | NCT-1 12/bx | 12 | 30" |
| MV-G122 | 3-0 | NSH 12/bx | 12 | 30" |
| MV-883 | 2-0 | NCT-2 12/bx | 12 | 30" |
| MV-811 | 2-0 | NCT-1 12/bx | 12 | 30" |
| MV-G123 | 2-0 | NSH 12/bx | 12 | 30" |
| MV-812 | 0 | NCT-1 12/bx | 12 | 30" |
| MV-884 | 0 | NCT-2 12/bx | 12 | 30" |
| MV-813 | 1 | NCT-1 12/bx | 12 | 30" |

REVERSE CUTTING NEEDLES

| Item# | Size | Needle | Qty | Length |
|--------|------|-------------|-----|--------|
| MV-635 | 4-0 | NFS-2 12/bx | 12 | 30" |
| MV-636 | 3-0 | NFS-2 12/bx | 12 | 30" |
| MV-637 | 2-0 | NFS-1 12/bx | 12 | 30" |
| MV-638 | 0 | NFS 12/bx | 12 | 30" |
| MV-817 | 0 | NCP-1 12/bx | 12 | 30" |
| MV-888 | 0 | NCP-2 12/bx | 12 | 30" |

\$19²⁸
/dozen

PLAIN GUT SUTURE

| Item# | Size | Needle | Qty | Length |
|---------|------|-------------|-----|--------|
| MV-H821 | 4-0 | NFS-2 12/bx | 12 | 30" |
| MV-H822 | 3-0 | NFS-2 12/bx | 12 | 30" |

Super Sharp Point Siliconized Needles

CHROMIC GUT SUTURE CASSETTE



Vet Use Only

Starting at

\$32⁹⁵

- **Composition:** Natural Purified Collagen
- **Absorption Type:** Absorbable
- **Structure:** Natural
- **Thread Color:** Brown

| Item# | Size | Length | Price |
|-------|--------------|--------|---------|
| CG30 | Cassette 3-0 | 50M | \$32.95 |
| CG20 | Cassette 2-0 | 50M | \$34.95 |
| CG10 | Cassette 0 | 50M | \$36.76 |
| CG01 | Cassette 1 | 50M | \$40.95 |
| CG02 | Cassette 2 | 50M | \$47.95 |

NEEDLE CHART *Super Sharp Point Siliconized Needles*

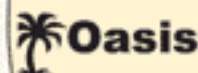

1/2 CIRCLE TAPER POINT

| Needle | Size |
|--------|------|
| NSH-1 | 22mm |
| NSH | 26mm |
| NCT-2 | 27mm |
| NCT-1 | 36mm |



Taper Point

3/8 CIRCLE REVERSE CUTTING

| Needle | Size |
|--------|------|
| NFS-2 | 19mm |
| NFS-1 | 24mm |
| NFS | 26mm |
| NFSL | 30mm |

1/2 CIRCLE REVERSE CUTTING POINT

| Needle | Size |
|--------|------|
| NCP-2 | 27mm |
| NCP-1 | 36mm |
| NX-1 | 23mm |



Reverse Cutting

Suture and Skin Closure

Polypropylene, Silk Suture & Braun Cassettes



POLYPROPYLENE SUTURE

REVERSE CUTTING NEEDLES

Blue Polypropylene Synthetic
Non-absorbable Suture



Oasis

\$22⁰⁰ /dozen

| Item# | Size Needle | Qty | Length |
|---------|-----------------|-----|--------|
| MV-8661 | 5-0 NFS-2 12/bx | 12 | 30" |
| MV-8663 | 4-0 NFS-2 12/bx | 12 | 30" |
| MV-8665 | 3-0 NFS-2 12/bx | 12 | 30" |
| MV-8684 | 3-0 NFS-1 12/bx | 12 | 30" |
| MV-8685 | 2-0 NFS 12/bx | 12 | 30" |

SILK SUTURE

Black Braided Suture
From Oasis



Oasis

\$9⁹⁹ /dozen

| Item# | Size Needle | Qty | Length |
|--------|-----------------|-----|--------|
| MV-682 | 5-0 NFS-2 12/bx | 12 | 30" |
| MV-683 | 4-0 NFS-2 12/bx | 12 | 30" |
| MV-629 | 4-0 NFS-1 12/bx | 12 | 30" |
| MV-684 | 3-0 NFS-1 12/bx | 12 | 30" |
| MV-685 | 2-0 NFS 12/bx | 12 | 30" |

Braunamid Cassette Suture

Suture consists of a large number of fine twisted strands covered by a smooth, seamless, homogeneous polyamide cover. Because of its polyfil construction, Braunamid thread is considerably more flexible than monofil sutures. Knot-pull tensile strength substantially exceeds USP requirements. Knot-holding ability is excellent due to its inner polyfilament structure. Non-capillary. Sterilized. Braunamid meets or exceeds all legal requirements set forth by the U.S. government.



| | | |
|-----------|--------------------------------|------------|
| JOR91-0 | Size 0 USP, Heavy 75m (246') L | \$49.50/pk |
| JOR91-1 | Size 1 USP, Heavy 75m (246') L | \$48.00/pk |
| JOR91-2 | Size 2 USP, 50m (164') L | \$43.50/pk |
| JOR91-2/0 | Size 2/0 USP, 100m (328') L | \$48.00/pk |
| JOR91-3 | Size 3 USP, 50m (164') L | \$43.50/pk |
| JOR91-3/0 | Size 3/0 USP, 100m (328') L | \$33.00/pk |
| JOR91-4 | Size 4 USP, 25m (82') L | \$40.50/pk |
| JOR91-4/0 | Size 4/0 USP, 100m (328') L | \$33.00/pk |
| JOR91-6 | Size 6 USP, 25m (82') L | \$42.00/pk |
| JOR91-8 | Size 8 USP, 25m (82') L | \$45.00/pk |

Pre-Cut Braunamid

| | |
|----------|------------|
| JOR91PC0 | \$3.00 /ea |
| JOR91PC3 | \$3.60 /ea |

Safil Cassette Sutures

| | | |
|----------|----------|-------------|
| JOR91SG2 | #2 - 15m | \$45.00/ea |
| JOR91SG5 | #5 - 25m | \$111.00/ea |



Braun Catgut Cassette Suture

Manufactured under continuous supervision from selected materials processed to high quality standards. It is accurately gauged and evenly chromed. High knot-pull tensile strength. Good knot-holding ability and exceptionally good handling qualities. Sterilized.

| | | |
|-----------|----------------------------|-------------|
| JOR91C0 | Size 0 USP, 50m (164') L | \$99.00/ea |
| JOR91C1 | Size 1 USP, 50m (164') L | \$105.00/ea |
| JOR91C2 | Size 2 USP, 50m (164') L | \$123.00/ea |
| JOR91C2/0 | Size 2/0 USP, 50m (164') L | \$82.50/ea |
| JOR91C3 | Size 3/0 USP, 50m (164') L | \$139.50/ea |
| JOR91C3/0 | Size 3/0 USP, 50m (164') L | \$67.50/ea |
| JOR91C4 | Size 4 USP, 25m (82') L | \$96.00/ea |
| JOR91C4/0 | Size 4/0 USP, 50m (164') L | \$75.00/ea |



Braun Catgut Cassette Suture (Non-Chromic)

| | | |
|----------|--------------------------|-------------|
| JOR91C6P | Size 6p USP, 25m (82') L | \$108.90/ea |
|----------|--------------------------|-------------|

Braun Stainless Steel Cassette Suture

Monofilament, corrosion-resistant steel. Extremely high knot-pull tensile strength. Stitch holds for an unlimited period of time. Sterilized.

| | | |
|-------------|---------------------------|------------|
| JOR91-S-0 | Size 0 USP, 50m (164') L | \$30.00/ea |
| JOR91-S-1 | Size 1 USP, 25m (82') L | \$30.00/bx |
| JOR91-S-2 | Size 2 USP, 25m (82') L | \$30.00/bx |
| JOR91-S-2/0 | SIZE 2-0 LENGTH 50m | \$30.00/ea |
| JOR91-S-3 | Size 3 USP, 20m (65') L | \$45.00/bx |
| JOR91-S-3/0 | Size 3/0 USP, 50m Long | \$30.00/ea |
| JOR91-S-4/0 | Size 4/0 USP, 50 (164') L | \$30.00/bx |
| JOR91-S-5/0 | Size 5/0 USP, 50m (164') | \$27.60/bx |



13822 WEST BOULTON BLVD. METTAWA, IL 60045

WWW.SHOPMEDVET.COM

Phone 800-544-7521

44

Fax 800-204-2177

ETHICON® SUTURE

Chromic/Plain Gut, Prolene, Ethilon & Silk



Chromic Gut Suture

| Item# | Details | Needle | Qty | Price |
|----------|---------|-----------|-------|----------|
| 634G-RL | 5-0 | FS-2 | 12/bx | \$92.49 |
| 635H-RL | 4-0 | FS-2 | 36/bx | \$247.21 |
| G181H-RL | 4-0 | SH-1 | 36/bx | \$192.08 |
| 636H-RL | 3-0 | FS-2 | 36/bx | \$247.21 |
| 882H-RL | 3-0 | CT-2 | 36/bx | \$215.21 |
| 810H-RL | 3-0 | CT-1 | 36/bx | \$215.21 |
| 886H-RL | 3-0 | CP-2 | 36/bx | \$222.32 |
| G182H-RL | 3-0 | SH-1 | 36/bx | \$215.21 |
| 892H-RL | 3-0 | CT-3/FN-2 | 36/bx | \$215.21 |
| G122H-RL | 3-0 | SH | 36/bx | \$215.21 |
| 637G-RL | 2-0 | FS-1 | 12/bx | \$50.00 |
| G127H-RL | 2-0 | MH | 36/bx | \$215.21 |
| 883H-RL | 2-0 | CT-2 | 36/bx | \$215.21 |
| 811H-RL | 2-0 | CT-1 | 36/bx | \$215.21 |
| 887H-RL | 2-0 | CP-2 | 36/bx | \$222.32 |
| 816H-RL | 2-0 | CP-1 | 36/bx | \$227.65 |
| G123H-RL | 2-0 | SH | 36/bx | \$215.21 |
| 802H-RL | 0 | CT | 36/bx | \$215.21 |
| 888H-RL | 0 | CP-2 | 36/bx | \$222.32 |
| 817H-RL | 0 | CP-1 | 36/bx | \$227.65 |
| 884H-RL | 0 | CT-2 | 36/bx | \$215.21 |
| 812H-RL | 0 | CT-1 | 36/bx | \$215.21 |
| G124H-RL | 0 | SH | 36/bx | \$215.21 |
| G128H-RL | 0 | MH | 36/bx | \$215.21 |
| 803H-RL | 1 | CT | 36/bx | \$215.21 |
| 885H-RL | 1 | CT-2 | 36/bx | \$215.21 |
| 813H-RL | 1 | CT-1 | 36/bx | \$215.21 |
| 865H-RL | 1 | CTX | 36/bx | \$215.21 |
| 905H-RL | 1 | CTX | 36/bx | \$218.76 |
| 814H-RL | 2 | CT-1 | 36/bx | \$215.21 |

Plain Gut Suture

| Item# | Details | Needle | Qty | Price |
|----------|---------|--------|-------|----------|
| H822H-RL | 3-0 | FS-2 | 36/bx | \$247.21 |



ETHICON® NEEDLE CHART

1/2 CIRCLE TAPER POINT

| Needle | Size | Needle | Size |
|--------|------|--------|------|
| CT-3 | 22mm | CTX | 48mm |
| CT-2A | 27mm | MH | 36mm |
| CT-1 | 36mm | RB-1 | 17mm |
| CT | 40mm | SH-1 | 22mm |
| | | SH | 26mm |

STRAIGHT

| Needle | Size |
|--------|------|
| KS | 60mm |

REVERSE CUTTING

3/8 CIRCLE REVERSE CUTTING

| Needle | Size | Needle | Size |
|--------|------|--------|------|
| FS-2 | 19mm | FSL | 30mm |
| FS-1 | 24mm | P-3 | 13mm |
| FS | 26mm | P-1 | 11mm |

1/2 CIRCLE REVERSE CUTTING

| Needle | Size |
|--------|------|
| CP-2 | 27mm |
| CP-1 | 36mm |
| X-1 | 23mm |

Prolene® Suture

| Item# | Details | Needle | Qty | Price |
|----------|---------|--------|-------|----------|
| 8695G-RL | 6-0 | P-3 | 12/bx | \$145.85 |
| 8697G-RL | 6-0 | P-1 | 12/bx | \$145.85 |
| 8698G-RL | 5-0 | P-3 | 12/bx | \$145.85 |
| 8681G-RL | 5-0 | PS-3 | 12/bx | \$147.62 |
| 8661G-RL | 5-0 | FS-3 | 12/bx | \$71.15 |
| 8683G-RL | 4-0 | FS-2 | 12/bx | \$71.15 |
| 8699G-RL | 4-0 | P-3 | 12/bx | \$145.85 |
| 8665G-RL | 3-0 | FS-2 | 12/bx | \$67.59 |
| 8684G-RL | 3-0 | FS-1 | 12/bx | \$71.15 |
| 8685H-RL | 2-0 | FS | 36/bx | \$198.45 |
| 8425H-RL | 1 | CT-1 | 36/bx | \$231.21 |
| 8424H-RL | 0 | CT-1 | 36/bx | \$231.21 |

Ethilon® Suture

| Item# | Details | Needle | Qty | Price |
|----------|---------|--------|-------|----------|
| 1665G-RL | 6-0 | PS-3 | 12/bx | \$124.50 |
| 697G-RL | 6-0 | P-1 | 12/bx | \$124.50 |
| 698G-RL | 5-0 | P-3 | 12/bx | \$124.50 |
| 661H-RL | 5-0 | FS-2 | 36/bx | \$165.41 |
| 661G-RL | 5-0 | FS-2 | 12/bx | \$56.91 |
| 1667G-RL | 4-0 | PS-2 | 12/bx | \$124.50 |
| 662H-RL | 4-0 | FS-2 | 36/bx | \$165.41 |
| 662G-RL | 4-0 | FS-2 | 12/bx | \$56.91 |
| 627H-RL | 3-0 | KS | 36/bx | \$184.97 |
| 663G-RL | 3-0 | FS-1 | 12/bx | \$56.91 |
| 663H-RL | 3-0 | FS-1 | 36/bx | \$165.41 |
| 669H-RL | 3-0 | FS-1 | 36/bx | \$165.41 |
| 628H-RL | 2-0 | KS | 36/bx | \$184.97 |
| 664G-RL | 2-0 | FS | 12/bx | \$56.91 |
| 664H-RL | 2-0 | FS | 36/bx | \$165.41 |
| 830H-RL | 1 | CTX | 36/bx | \$206.31 |

Silk Suture

| Item# | Details | Needle | Qty | Price |
|---------|---------|--------|-------|----------|
| 640G-RL | 5-0 | P-3 | 12/bx | \$129.82 |
| 683G-RL | 4-0 | FS-2 | 12/bx | \$55.14 |
| 685G-RL | 2-0 | FS | 12/bx | \$56.91 |

Ethicon suture subject to availability and price fluctuations. Call to confirm

13822 WEST BOULTON BLVD. METTAWA, IL 60045

WWW.SHOPMEDVET.COM

Phone 800-544-7521

45

Fax 800-204-2177

ETHICON® SUTURE



Monocryl, PDSII & Vicryl

Monocryl® Suture

| Item# | Details | Needle | Qty | Price |
|----------|---------|--------|-------|----------|
| Y922H-RL | 4-0 | FS-2 | 36/bx | \$232.98 |
| Y923H-RL | 3-0 | FS-2 | 36/bx | \$232.98 |
| Y316H-RL | 3-0 | SH | 36/bx | \$195.63 |
| Y338H-RL | 3-0 | CT-1 | 36/bx | \$197.41 |
| Y344H-RL | 3-0 | CT-1 | 36/bx | \$231.21 |
| Y942H-RL | 3-0 | FS-1 | 36/bx | \$227.65 |
| Y317H-RL | 2-0 | SH | 36/bx | \$195.63 |
| Y339H-RL | 2-0 | CT-1 | 36/bx | \$197.41 |
| Y345H-RL | 2-0 | CT-1 | 36/bx | \$231.21 |
| Y943H-RL | 2-0 | FS-1 | 36/bx | \$227.65 |
| Y334H-RL | 0 | CT-2 | 36/bx | \$195.63 |
| Y340H-RL | 0 | CT-1 | 36/bx | \$197.41 |
| Y346H-RL | 0 | CT-1 | 36/bx | \$231.21 |
| Y341H-RL | 1 | CT-1 | 36/bx | \$197.41 |
| Y347H-RL | 1 | CT-1 | 36/bx | \$231.21 |
| Y353H-RL | 1 | CT | 36/bx | \$199.20 |

PDS II® Suture

| Item# | Details | Needle | Qty | Price |
|-----------|---------|--------|-------|----------|
| Z303H-RL | 5-0 | RB-1 | 36/bx | \$227.65 |
| Z421H-RL* | 5-0 | FS-2 | 36/bx | \$266.77 |
| Z463G-RL | 5-0 | P-3 | 12/bx | \$152.95 |
| Z304H-RL | 4-0 | RB-1 | 36/bx | \$227.65 |
| Z310H-RL | 4-0 | SH-1 | 36/bx | \$227.65 |
| Z315H-RL | 4-0 | SH | 36/bx | \$218.76 |
| Z496G-RL* | 4-0 | PS-2 | 12/bx | \$152.95 |
| Z397H-RL | 4-0 | FS-2 | 36/bx | \$236.55 |
| Z422H-RL* | 4-0 | FS-2 | 36/bx | \$266.77 |
| Z305H-RL | 3-0 | RB-1 | 36/bx | \$227.65 |
| Z332H-RL | 3-0 | CT-2 | 36/bx | \$215.21 |
| Z338H-RL | 3-0 | CT-1 | 36/bx | \$215.21 |
| Z968H-RL | 3-0 | CP-2 | 36/bx | \$323.68 |
| Z465H-RL | 3-0 | CP-1 | 36/bx | \$191.00 |
| Z423H-RL* | 3-0 | FS-2 | 36/bx | \$266.77 |
| Z442H-RL* | 3-0 | FS-1 | 36/bx | \$266.77 |
| Z452H-RL | 3-0 | FS-1 | 36/bx | \$229.43 |
| Z311H-RL | 3-0 | SH-1 | 36/bx | \$227.65 |
| Z316H-RL | 3-0 | SH | 36/bx | \$218.76 |
| Z317H-RL | 2-0 | SH | 36/bx | \$218.76 |
| Z333H-RL | 2-0 | CT-2 | 36/bx | \$215.21 |
| Z339H-RL | 2-0 | CT-1 | 36/bx | \$215.21 |
| Z969H-RL | 2-0 | CP-2 | 36/bx | \$323.68 |
| Z466H-RL | 2-0 | CP-1 | 36/bx | \$236.55 |
| Z443H-RL* | 2-0 | FS-1 | 36/bx | \$266.77 |
| Z451H-RL | 2-0 | FS-1 | 36/bx | \$229.43 |
| Z334H-RL | 0 | CT-2 | 36/bx | \$215.21 |
| Z340H-RL | 0 | CT-1 | 36/bx | \$215.21 |
| Z970H-RL | 0 | CP-2 | 36/bx | \$323.68 |
| Z467H-RL | 0 | CP-1 | 36/bx | \$236.55 |
| Z341H-RL | 1 | CT-1 | 36/bx | \$215.21 |
| Z468H-RL | 1 | CP-1 | 36/bx | \$236.55 |

Vicryl® Suture

| Item# | Details | Needle | Qty | Price |
|-----------|---------|------------------|-------|----------|
| J548G-RL | 8-0 | TG140-8, TG140-8 | 12/bx | \$499.77 |
| J488G-RL* | 7-0 | P-1 | 12/bx | \$133.39 |
| J489G-RL* | 6-0 | P-1 | 12/bx | \$133.39 |
| J492G-RL* | 6-0 | P-3 | 12/bx | \$133.39 |
| J493G-RL* | 5-0 | P-3 | 12/bx | \$133.39 |
| J493H-RL* | 5-0 | P-3 | 36/bx | \$264.00 |
| J385H-RL | 5-0 | C-3 | 36/bx | \$229.43 |
| J391H-RL | 5-0 | FS-2 | 36/bx | \$229.43 |
| J422H-RL* | 4-0 | FS-2 | 36/bx | \$229.43 |
| J392H-RL | 4-0 | FS-2 | 36/bx | \$229.43 |
| J397H-RL | 4-0 | FS-2 | 36/bx | \$263.22 |
| J494G-RL* | 4-0 | P-3 | 12/bx | \$133.39 |
| J504G-RL* | 4-0 | P-2 | 12/bx | \$133.39 |
| J310H-RL | 4-0 | SH-1 | 36/bx | \$190.30 |
| J451H-RL | 4-0 | FS-1 | 36/bx | \$263.22 |
| J311H-RL | 3-0 | SH-1 | 36/bx | \$190.30 |
| J316H-RL | 3-0 | SH | 36/bx | \$186.75 |
| J416H-RL* | 3-0 | SH | 36/bx | \$190.30 |
| J327H-RL | 3-0 | CT-3 | 36/bx | \$190.30 |
| J332H-RL | 3-0 | CT-2 | 36/bx | \$190.30 |
| J338H-RL | 3-0 | CT-1 | 36/bx | \$190.30 |
| J344H-RL | 3-0 | CT-1 | 36/bx | \$216.97 |
| J393H-RL | 3-0 | FS-2 | 36/bx | \$229.43 |
| J423H-RL* | 3-0 | FS-2 | 36/bx | \$229.43 |
| J398H-RL | 3-0 | FS-2 | 36/bx | \$261.44 |
| J442H-RL* | 3-0 | FS-1 | 36/bx | \$227.65 |
| J452H-RL | 3-0 | FS-1 | 36/bx | \$263.22 |
| J460H-RL | 3-0 | X-1 | 36/bx | \$229.43 |
| J471H-RL | 3-0 | CP-1 | 36/bx | \$222.32 |
| J465H-RL | 3-0 | CP-1 | 36/bx | \$140.00 |
| J317H-RL | 2-0 | SH | 36/bx | \$186.75 |
| J328H-RL | 2-0 | CT-3 | 36/bx | \$190.30 |
| J333H-RL | 2-0 | CT-2 | 36/bx | \$190.30 |
| J339H-RL | 2-0 | CT-1 | 36/bx | \$190.30 |
| J345H-RL | 2-0 | CT-1 | 36/bx | \$222.32 |
| J466H-RL | 2-0 | CP-1 | 36/bx | \$193.86 |
| J443H-RL* | 2-0 | FS-1 | 36/bx | \$227.65 |
| J453H-RL | 2-0 | FS-1 | 36/bx | \$263.22 |
| J461H-RL | 2-0 | X-1 | 36/bx | \$229.43 |
| J334H-RL | 0 | CT-2 | 36/bx | \$190.30 |
| J340H-RL | 0 | CT-1 | 36/bx | \$190.30 |
| J346H-RL | 0 | CT-1 | 36/bx | \$222.32 |
| J467H-RL | 0 | CP-1 | 36/bx | \$193.86 |
| J341H-RL | 1 | CT-1 | 36/bx | \$190.30 |
| J468H-RL | 1 | CP-1 | 36/bx | \$193.86 |
| J195H-RL* | 2 | CP | 36/bx | \$229.43 |
| J649G-RL | 2 | TP-1 | 12/bx | \$439.29 |

Ethicon suture subject to availability and price fluctuations, call to confirm

For Needle Chart Please See Previous Page

13822 WEST BOULTON BLVD. METAWA, IL 60045

WWW.SHOPMEDVET.COM

Phone 800-544-7521

46

Fax 800-204-2177

Suture and Skin Closure

Braun® & Jorvet Suture

Suture Brand Comparison: Braun Ethicon

| | | |
|-----------------------------------|-----------|--------|
| Absorbable synthetic braided | Safil | Vicryl |
| Absorbable synthetic monofilament | Monosyn | PDS |
| Multi-filament nylon w/sheath | Braunamid | N/A |

Needle-Suture Combinations by B. Braun.

Catgut Chromic.

1/2-Circle Round Bodied Needle.

| | | |
|------|------|----------------|
| HR22 | 75cm | 3/0, 2/0 |
| HR26 | 75cm | 4/0, 3/0, 0, 1 |
| HR30 | 75cm | 3/0 |
| HR37 | 75cm | 3/0, 2/0, 0 |

1/2-Circle Reverse Cutting Needle.

| | | |
|-------|------|----------|
| HS26 | 75cm | 3/0, 2/0 |
| HS37s | 75cm | 2/0, 0 |

3/8-Circle Reverse Cutting Needle.

| | | |
|------|------|------------------|
| DS24 | 75cm | 4/0, 3/0, 2/0, 0 |
| DS30 | 75cm | 2/0 |

Braunamid, Black.

3/8-Circle Reverse Cutting Needle.

| | | |
|-------|------|-------------|
| DS24b | 45cm | 3/0 |
| DS30b | 45cm | 3/0, 2/0, 0 |

1 x 12 Peel Packs.

Needle Comparison Chart.

| Jorvet | Ethicon |
|--------|---------|
| HR26 | SH |
| DS24 | FS-1 |
| DS19 | FS-2 |
| HS37S | CP-1 |
| HR37 | CT-1 |

Needle Comparison Chart.

| Jorvet | Ethicon |
|--------|---------|
| HR22 | CT-2 |
| HR17 | RB-1 |
| HR30 | — |
| DS16 | — |
| DS30 | CP-2 |
| HS26 | — |
| HS26s | — |

Monosyn

- Absorbable monofilament suture made of glyconate.
- Considered a mid-term suture in regard to absorption as it retains 50 percent of tensile strength up to 14 days.
- Exceptional knot security and knot tensile strength.

- Smooth monofilament for ease of passage through tissue.
- Braided suture "feel"
- Absorbed via hydrolysis
- Violet color for easy identification

| Product Code | Details | Price |
|--------------|-----------------------|-------------|
| JORG22247 | HS37S, 2/0, 12 pk/box | \$56.10 /dz |
| JORG22249 | HS37S, 1, 12 pk/box | \$63.00 /dz |
| JORG22248 | HS37S, 0, 12 pk/box | \$59.40 /dz |
| JORG22241 | HS26S, 3/0, 12 pk/box | \$57.00 /dz |
| JORG22242 | HS26S, 2/0, 12 pk/box | \$60.00 /dz |
| JORG22243 | HS26S, 0, 12 pk/box | \$60.00 /dz |
| JORG22236 | HS26, 0, 12 pk/box | \$63.00 /dz |
| JORG22237 | HS26, 0, 12 pk/box | \$60.00 /dz |
| JORG22048 | HR37, 1, 12 pk/box | \$58.50 /dz |
| JORG22046 | HR37, 0, 12 pk/box | \$66.00 /dz |

Monosyn Violet

Absorbable monofilament suture made of glyconate. Considered a mid-term suture in regard to absorption as it retains 50 percent of tensile strength up to 14 days. Exceptional knot security and knot tensile strength. Smooth monofilament for ease of passage through tissue.

- Braided suture "feel"
- Absorbed via hydrolysis
- Violet color for easy identification

| Product Code | Details | Price |
|--------------|-------------------------------|-------------|
| JORG22461 | HS37S, 2/0, 90cm L, 12 pk/box | \$60.00 /dz |
| JORG22477 | HS37S, 0, 90cm L, 12 pk/box | \$66.00 /dz |
| JORG22371 | HS37, 3/0, 90cm L, 12 pk/box | \$78.00 /dz |
| JORG22299 | HS26, 2/0, 90cm L, 12 pk/box | \$78.00 /dz |
| JORG22456 | HR37S, 2/0, 90cm L, 12 pk/box | \$72.00 /dz |
| JORG22457 | HR37S, 0, 90cm L, 12 pk/box | \$72.00 /dz |
| JORG22445 | HR37, 3/0, 90cm L, 12 pk/box | \$60.00 /dz |
| JORG22448 | HR37, 1, 90cm L, 12 pk/box | \$66.00 /dz |
| JORG22485 | HR26S, 3/0, 90cm L, 12 pk/box | \$60.00 /dz |
| JORG22486 | HR26S, 2/0, 90cm L, 12 pk/box | \$60.00 /dz |
| JORG22824 | HR26, 4/0, 90cm L, 12 pk/box | \$72.00 /dz |
| JORG22425 | HR26, 3/0, 90cm L, 12 pk/box | \$60.00 /dz |
| JORG22426 | HR26, 2/0, 90cm L, 12 pk/box | \$66.00 /dz |
| JORG22003 | HR17-5/0, 90cm L, 12 pk/box | \$60.00 /dz |
| JORG22811 | HR17, 4/0, 90cm L, 12 pk/box | \$66.00 /dz |
| JORG22349 | DS30-0, 90cm, 12 pk/box | \$66.00 /dz |
| JORG22225 | DS24, 3/0, 90cm, 12 pk/box | \$57.00 /dz |
| JORG22226 | DS24, 2/0 90cm, 12 pk/box | \$60.00 /dz |
| JORG22904 | DS19, 4/0, 90cm L, 12 pk/box | \$57.00 /dz |
| JORG22905 | DS19, 3/0, 90cm L, 12 pk/box | \$60.00 /dz |

When Ordering Specify: A B # # C

A = Needle Angle of Curvature:

H: 1/2-Circle OR D: 3/8-Circle

B = Body Type: R: Round-bodied or

S: Reverse cutting needle

= Needle Length:

Distance along the needle side between its point and its end, in millimeters.

C = Wire Size: S: Heavy body needle

Example: HR26 = 1/2-circle, round-bodied needle 26mm L.

| Product Code | Details | Price |
|--------------|------------------------------|-------------|
| JORG22047 | HR37, 0, 12 pk/box | \$61.50 /dz |
| JORG22035 | HR30, 3/0, 70cm L, 12 pk/box | \$54.00 /dz |
| JORG22036 | HR30, 2/0, 12 pk/box | \$60.00 /dz |
| JORG22037 | HR30, 0, 45cm L, 12 pk/box | \$69.00 /dz |
| JORG22024 | HR26, 4/0, 12 pk/box | \$66.00 /dz |
| JORG22025 | HR26, 3/0, 12 pk/box | \$66.00 /dz |
| JORG22027 | HR26, 0, 12 pk/box | \$66.00 /dz |
| JORG22026 | HR26, /0, 12 pk/box | \$63.00 /dz |
| JORG22015 | HR22-3/0, 12 pk/box | \$57.00 /dz |
| JORG22231 | DS30, 2/0, 12 pk/box | \$57.00 /dz |
| JORG22233 | DS30, 1, 12 pk/box | \$57.00 /dz |

Safil® Suture Jorvet

Safil® is a violet dyed precision-braided and coated synthetic suture made from pure polyglycolic acid.

- Easy handling
- Excellent knotting ability
- Secure knot tying
- High initial tensile strength
- Smooth passage through the tissue

Armed with a new generation of needles "Easyslide" Safil® is degraded by hydrolysis, providing predictable and reliable absorption. Safil maintains 50 percent of its initial tensile strength after 18 days and is fully absorbed after 90 days.

| Product Code | Details | Price |
|--------------|-----------------------|------------|
| JORG-48294 | HS37S, 2/0, 12 pk/box | \$49.50/dz |
| JORG-48296 | HS37S, 0, 12 pk/box | \$49.50/dz |
| JORG-48053 | HR37, 1, 12pk/box | \$60.00/dz |
| JORG-48052 | HR37, 0, 12pk/box | \$49.50/dz |
| JORG-48041 | HR26, 3/0, 12pk/box | \$54.00/dz |
| JORG-48042 | HR26, 2/0, 12pk/box | \$57.00/dz |
| JORG-48235 | DS24, 2/0, 12pk/box | \$60.00/dz |
| JORG-48236 | DS24, 2/0, 12pk/box | \$60.00/dz |
| JORG-48220 | DS19, 4/0, 12pk/box | \$54.00/dz |
| JORG-48221 | DS19, 3/0, 12pk/box | \$54.00/dz |

Jorvet Safil Conversion Chart.

| Jorvet/Safil# | Safil Needle & Suture Size | Vicryl# | Vicryl Needle |
|---------------|----------------------------|---------|---------------|
| JG-48041 | HR26-3/0 | J316H | SH |
| JG-48042 | HR26-2/0 | J317H | SH |
| JG-48235 | DS24-3/0 | H452H | FS-1 |
| JG-48236 | DS24-2/0 | H453H | FS-1 |
| JG-48220 | DS19-4/0 | J-397H | FS-2 |
| JG-48221 | DS19-3/0 | J-398H | FS-2 |
| JG-48294 | HS37S-2/0 | J466H | CP-1 |
| JG-48296 | HS37S-0 | J467H | CP-1 |
| JG-48052 | HR37-0 | J340H | CT-1 |
| JG-48053 | HR37-1 | J341H | CT-1 |

Ethicon/Dexon®/USSDG Comparisons available upon request



| Product Code | Details | Price |
|--------------|---------------------------|-------------|
| JORG22232 | DS30, 0, 12 pk/box | \$57.00 /dz |
| JORG22217 | DS24-, 0, 12 pk/box | \$50.00 /dz |
| JORG22215 | DS24, 3/0, 12 pk/box | \$55.50 /dz |
| JORG22216 | DS24, 2/0, 12 pk/box | \$57.75 /dz |
| JORG-22217 | DS24, 0, 70cm L, 12pk/box | \$50.00 /dz |
| JORG22204 | DS19, 4/0, 12 pk/box | \$55.50 /dz |
| JORG22504 | DS19, 4/0, 12 pk/box | \$54.00 /dz |
| JORG22205 | DS19, -3/0, 12 pk/box | \$57.00 /dz |
| JORG22419 | DS16, 5/0, 12 pk/box | \$54.00 /dz |
| JORG22220 | DS16, 0, 12 pk/box | \$48.00 /dz |

13822 WEST BOULTON BLVD. METTAWA, IL 60045

Phone 800-544-7521

WWW.SHOPMEDVET.COM

Fax 800-204-2177

Suture and Skin Closure

Jorvet Hemostatic Ligation Clips/Apliers

Jorvet Titanium Hemostatic Clip

Pure titanium annealed to a malleable consistency providing maximum vessel occlusion and zero memory to prevent tip opening after application. Biologically inert, radiolucent and non-magnetic for use with MRI or related scanning equipment.

Chevron shape provides progressive and encompassing tip-to-tip closure before complete and secure occlusion of tissue or vessel.

Diamond-shaped grooving and interlocking atraumatic teeth design of the clip ensures enhanced security in vessel closure. Striation is composed of small pyramidal heads, similar to tungsten inserts from needle-holders, insuring a firm, multidirectional, non-hurting vessel grip.

Triangular-shaped wire fits perfectly into the custom grooves of our applicators to provide mechanical power during application of the clip. Specially designed surface treatment and annealing provide a secure atraumaticity.

The exclusive small/medium size has been designed to match specific intermediary vessel sizes requested by surgeons. The cartridge is designed with effective clip retention, adhesive cartridge backing, and ergonomic design to insure precise and effortless clip loading.

Jorvet



| Cartridges | | | | | | |
|------------|--------|-------------|-------------|--------|--|--|
| Size | Color | Clip Closed | Clip Opened | Width | | |
| Small | Yellow | 3.6mm | 2.9mm | 3.5mm | | |
| Small/Med. | Lilac | 4.6mm | 4.1mm | 4.5mm | | |
| Medium | Blue | 5.6mm | 4.7mm | 5.9mm | | |
| Med./Large | Green | 9mm | 7.8mm | 8.5mm | | |
| Large | Orange | 12.3mm | 10.8mm | 11.4mm | | |

| Applicators | | | | | |
|-------------|--------|---------|----------|----------|------------------------|
| Size | Color | 15cm | 19cm | 28cm | 28cm Right-Angled Jaws |
| Small | Yellow | JOR796a | JOR796aL | -- | -- |
| Small/Med. | Lilac | JOR796b | JOR796bL | -- | -- |
| Medium | Blue | JOR796c | JOR796cL | -- | -- |
| Med./Large | Green | | JOR796d | JOR796dL | JOR796dLa |
| Large | Orange | | JOR796e | JOR796eL | JOR796eLa |



Titanium Hemostatic Sterile Clips (Ligating Clips)

| | | |
|---------|--|--------------|
| JOR795A | Small, 30 cartridges of 6 clips | \$102.75 /pk |
| JOR795B | Medium/Small, 30 cartridges of 6 clips | \$114.00 /pk |
| JOR795D | Medium/Large, 20 cartridges of 6 clips | \$114.00 /pk |
| JOR795C | Medium, 30 cartridges of 6 clips | \$114.00 /pk |
| JOR795E | Large, 20 cartridges of 6 clips | \$129.00 /pk |

Titanium Hemostatic Sterile Clips (Applicators)

| | | |
|-----------|---|--------------|
| JOR796AL | Small clip applicator, Yellow, 19cm | \$97.00 /ea |
| JOR796A | Small Clip Applicator, Yellow, 15cm | \$97.00 /ea |
| JOR796BL | Medium/Small clip applicator, Lilac, 19cm | \$97.00 /ea |
| JOR796B | Medium/Small clip applicator, Lilac, 15cm | \$108.00 /ea |
| JOR796DLA | Medium/large clip applicator, Green, angled 28cm, Right Angle | \$97.00 /ea |
| JOR796DL | Medium/Large clip applicator, Green, 28cm | \$97.00 /ea |
| JOR796D | Medium/large clip applicator, Green, 19cm | \$97.00 /ea |
| JOR796CL | Medium clip applicator, Blue, 19cm | \$97.00 /ea |
| JOR796C | Medium clip applicator, Blue, 15cm | \$97.00 /ea |
| JOR796ELA | Large clip applicator, Orange, angled 28cm Right Angle | \$97.00 /ea |
| JOR796E | Large clip applicator, Orange, 19cm | \$97.00 /ea |
| JOR796EL | Large clip applicator, Green, 28cm | \$97.00 /ea |



Michel Forceps **Jorvet**

Can be used both for applying and removing Michel clips.

| | | |
|-------|------------------------|------------|
| JOR86 | Stainless steel, 12cm. | \$42.00/ea |
|-------|------------------------|------------|

Michel Clips **Jorvet**

| | | |
|--------|---------------------------------|------------|
| JOR86A | 7.5mm x 1.75mm, 100 clips/rack. | \$12.00/bx |
| JOR86C | 18mm x 3mm, 100 clips/rack. | \$12.00/bx |
| JOR86B | 14mm x 3mm, 100 clips/rack. | \$12.00/bx |

LigaFiba Braided Polyethylene Fiber (Material Only) **Jorvet**

Monofilament nylon has been the standard suture material for the lateral suture technique for repair of CCL damage. Newer materials are made of braided polyethylene fiber and offer several advantages over nylon.

- Significantly stronger (up to 15 times)
- Better flex fatigue resistance and abrasion
- Knots tie easier. This makes LigaFiba suture material an ideal material for ligament and tendon repair. Its available packages are:
- LigaFiba suture material only
- Provided with attached cruciate needle and straight needle
- LigaFiba with toggle buttons in bone tunnel procedures in both cruciate and hip repairs

| | | |
|---------|-----------------------------|------------|
| JOR444A | 150 lb test X 500mm length | \$15.00/ea |
| JOR444B | 250lb Test x 600mm sterile | \$17.50/ea |
| JOR444C | 500 lb. test X 600mm length | \$20.00/ea |



LigaFiba ISO Toggle Suture **Jorvet**

A newer technique for extra capsular repair of CCL damage uses a bone tunnel between iso metric point on the femur. A set of small toggles are used instead of passage through the fabella ligament. The LigaFiba is passed through the bone tunnel with an attached straight needle. Step by step guidelines available. The LigaFiba can be readily tied by the toggle button. Step by step guidelines available. The LigaFiba can be readily tied by the toggle button.

| | | |
|---------|--|-------------|
| JOR444F | 250 lb test (dogs up to 50lbs) Bone tunnel use JOR372cx, 2.5mm drill | \$88.00 /ea |
| JOR444G | 500 lb test (dogs over 50lbs) Bone tunnel use JOR372fx, 3.5mm drill | \$96.00 |



LigaFiba Lateral Suture

LigaFiba lateral suture with swaged on needles one end has attached cruciate needle for fabella ligament passage. The other end a straight needle for passing through tibial crest. The LigaFiba ties easily but also can be crimped (require Jorvet fiber crimp instrument JOR710x) and Jorvet fiber crimp JOR448a. Sterile package.

| | | |
|---------|------------------|-------------|
| JOR444E | 500lb w/needles | \$31.50 /ea |
| JOR444D | 20 lb. w/needles | \$31.50 /ea |



13822 WEST BOULTON BLVD. METTAWA, IL 60045

Phone 800-544-7521

48

WWW.SHOPMEDVET.COM

Fax 800-204-2177

Suture and Skin Closure

Skin Staplers



Oasis Skin Stapler

This skin stapler is affordable and simple. Its simplistic design and quality construction provides consistent and reliable performance. It fits comfortably in your hand to enhance control and also reduces surgery time. 35 staples.

- Individually sterile packed in boxes of 6
- Lever action staplers are the most popular design on the market
- Short trigger stroke for ease of use
- Handle design comfortably fits a wide range of hand sizes
- Angled head allows visibility of incision to ensure precise staple placement
- Arrow indicator assists in accurate staple alignment
- Staple count indicator allows you to view staples remaining to help minimize waste
- Quality construction and simple design assure reliable consistent performance.

| | | |
|-----|-------------------------------------|-----------|
| 35R | Regular, 5.4 x 3.6 mm after closure | \$6.95/ea |
| 35W | Wide, 7mm x 4mm after closure | \$6.95/ea |



STERILE



(12+) \$5.95/ea

Surgiclose Skin Stapler

Wound closure with the most economical external stapler just became easier. Over 80 percent of all human surgical wound closures involve the use of skin staplers. In veterinary surgery, less than 10 percent of surgeries utilize skin staplers. Why is there such a wide difference in usage? The use of skin staplers has been limited in veterinary surgery due to the high cost of disposable human skin staplers. The use of sutures with needle packs has been less expensive to close the skin (average cost ranges \$4-\$5). The introduction of the SurgiClose stapling system addresses the specific needs of the veterinary surgeon. Benefits:

- Better apposition of skin edges with better cosmetic results.
- Less reactivity of stainless steel staples
- Significantly faster wound closure
- Ease of learning proper technique.

Features:

- 20-pack staple cartridges cost less than a pack of needle suture, and is a huge savings over conventional throw away skin staples
- Both handle and staples are provided sterile
- Staple cartridges are inserted into the handle and are specially designed to reduce jamming
- Handle can be autoclaved for repeated use
- 20-staple cartridge sufficiently closes a 4"-5" incision
- Closed staple shaped squarely, restricting movement or rolling of a staple

| | | |
|-------|------------------------|------------|
| SC02H | Low Temp Autoclavable | \$4.99 /ea |
| SC03H | High Temp Autoclavable | \$7.99 /ea |
| SC36C | 6 Cartridges | \$33.99/ea |

Surgi-Close (Staple Handle)

Staple handle requires cleaning and sterilizing between uses, but there is no longer the need to lubricate the former between uses. Each staple is lubricated with a coating of USP Sodium Stearate for easy penetration, reducing forming force and release from the former. Staple handle packaged in sterile pouch from a dispensing box.

| | | |
|--------|--------------|-------------|
| JOR799 | Sterile, 6pk | \$78.00 /pk |
|--------|--------------|-------------|

Surgi-Close Stapler (Staples)

Staples are now lubricated with USP Sodium Stearate to promote easier forming taking less force and quicker release without the necessity to lubricate the handle between uses. This takes the hassle out of using cost effective stapling for wound closure. Staples are packaged in a sterile pouch from a dispensing box.

| | | |
|---------|-------------------------------------|--------------|
| JOR800 | 20/pk Cartridge, 36 Cartridges/box. | \$215.00 /ea |
| JOR800X | 24 cartridges of 20 staples | \$121.00 /ea |

Surgi-Close (Staple Removal Forceps)

| | | |
|---------|---|--------|
| JOR799R | Staple Removal Forceps will work with any brand of skin staple. | \$5.70 |
|---------|---|--------|

Surgi-Close Starter Kit

- Starter Kit Includes:
- 6 cartridges of 20 staples
 - 1 stapler handle
 - Staple removal forceps

| | |
|---------|-------------|
| JOR800S | \$58.00 /ea |
|---------|-------------|

Skin Staple Remover

| | | |
|-----------|------|------------|
| STAPLEREM | Each | \$1.95 /ea |
|-----------|------|------------|

Premium German Skin Stapler

Quality German made sterile skin stapler containing 35 wide stainless steel (316 L) staples. Staple size 6.8 mm x 3.9 mm. The TOHAMED skin stapler saves time and money and closes wounds gently and securely. Due to its ergonomic design this appliance meets all expectations demanded from a reliable surgical device.

| | | |
|---------|----------------------------------|------------|
| 35W-GER | Wide, 6.8 x 3.9 mm after closure | \$7.95 /ea |
|---------|----------------------------------|------------|

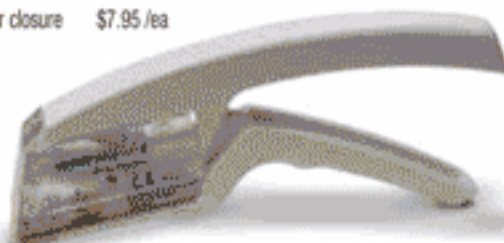

Braun Manipler® AZ Suture Stapler

Braun/Aesculap. Newest development in surgical skin staplers. This is lightweight with a modern ergonomic design. This model is very popular in Europe.

- Type - wide
- 35 staples per staple handle
- Crown - 6.9mm
- Leg 3.6mm
- 6 staplers per box
- Sterile



| | | |
|---------|-------------------------------|-------------|
| JOR800M | Crown 6.9mm, Leg 3.6mm, 6/box | \$84.00 /pk |
|---------|-------------------------------|-------------|

13822 WEST BOULTON BLVD. METTAWA, IL 60045

Phone 800-544-7521

49

WWW.SHOPMEDVET.COM

Fax 800-204-2177

Suture and Skin Closure

Tissue Adhesive & Suture Removal



TISSUE ADHESIVE

Veterinary use only. Tissue Adhesive monomeric formulation that forms a thin, waterproof adhesion.

- Polymerizes in 5 seconds
- Designed for De-claw Procedures & Skin Closure
- Comes with 5 Sterile applicators
- 3g, Color Blue



\$10⁹⁵/ea

Item# TA5



Oasis Liquivet Tissue Adhesive

- LiquiVet monomeric formulation that forms a thin, waterproof adhesion.
- LiquiVet comes in larger bottles compared to other tissue adhesives. 3g dispensing bottle with 5 sterile applicators.

Vet use only.

Item# VG3

- Polymerizes in 2 seconds
- De-claw procedures
- 3g

Item# VG3SC

- Polymerizes in 8 seconds
- Skin Closure
- 3g

\$10⁹⁵/ea



Jorvet Umbilical Tape

Braided Polyester Tape In Plastic Bottles

| | | |
|---------|-----------------------------|-------------|
| JOR25UA | Non-Sterile, 1/8" x 20 yds. | \$9.30 /ea |
| JOR25UB | Non-Sterile, 3/8" x 20 yds. | \$12.30 /ea |
| JOR25UC | Non-Sterile, 1/4" X 20 yds | \$10.50 /ea |



Jorvet Suture Wire

Suture Wire Stainless Steel

| | | |
|------------|------------------------------|------------|
| MIL9-40-36 | .005 Diam., 13mm, 1oz, Spool | \$18.10/ea |
|------------|------------------------------|------------|



Bone Wax

Allows the effective control of bleeding from bone surfaces.

| | | |
|------|--------------------|-----------|
| BW25 | 2.5Gm Sterile Each | \$5.95/ea |
|------|--------------------|-----------|



Jorvet Suture Kits

| | | |
|---------|---|-----------|
| JOR91KA | Equine, Size 0 Braunamid with #2 3/8 reverse cut suture needle | \$4.80/ea |
| JOR91KB | Bovine, #3 Braunamid suture with XL 3/8 reverse cut needle | \$5.40/ea |
| JOR91KC | Small Animal, Size 0 Braunamid with #8 3/8 reverse cut suture needle | \$4.80/ea |
| JOR91KD | Calves and Pigs, Braunamid 60" long with size 2 needle, 3/8 reverse cut | \$5.40/ea |

DA Suture Needless

| | | |
|---------|-----------------------------|------------|
| JOR110A | Tapered 8" curve tip to tip | \$31.50/ea |
| JOR110B | Reverse cutting, curved, 8" | \$31.50/ea |

JOR110A

JOR110SL

Jorvet

Double-Curved Suture Needless

| | | |
|----------|-----------------------|------------|
| JOR110SL | Large, 5", 12/pk. | \$18.00/dz |
| JOR110SM | Medium, 3 1/2", 12/pk | \$18.00/dz |

JOR110SA

Jorvet

Heavy Duty Suture-Needles Half Curved

Heavy duty 1/2 circle needles. Stainless steel cutting edge.

| | | |
|-----------|---------------------------|------------|
| JOR110HC | 1/2 circle needles, 12/pk | \$19.50/pk |
| JOR110HC3 | Size 3", 12/pk | \$19.50/pk |
| JOR110HC4 | Size 4", 12/pk | \$19.50/pk |
| JOR110HC5 | Size 5", 12/pk | \$19.50/pk |
| JOR110HC6 | Size 6", 12/pk | \$19.50/pk |

Jorvet



Suture Removal Kit

Sterile Suture Removal Tray Includes:

- Metal Littauer Scissors
- Deluxe Suture Forceps
- Gauze Pad

| | | |
|------------|------|-----------|
| SUTURE-REM | Tray | \$1.99/ea |
|------------|------|-----------|



Needle Sterilization Rack

| | | |
|---------|------|------------|
| MIL3-50 | Rack | \$28.88/ea |
|---------|------|------------|



Needle Rack

Convenient spring action model for holding suture needles.

| | |
|---------|---------|
| JOR105R | \$15.00 |
|---------|---------|



13822 WEST BOULTON BLVD. METTAWA, IL 60045

WWW.SHOPMEDVET.COM

Phone 800-544-7521

50

Fax 800-204-2177

Suture and Skin Closure

Jorvet & Miltex Suture Needles



Reverse Cutting Suture Needles

Choose from a full selection of needles for all veterinary needs. Sizes available include 2, 4, 6, 8, 10, 11, 12, 13, 14, 16, 18 and 20 in 3/8-circle. 12/pk. Price is for (1) 12/pk of one size only. Please specify size when ordering. **Jorvet**

| | | |
|-----------|---|------------|
| JOR7011 | 3/8 circle, dozen | \$9.30/pk |
| JOR7031 | 1/2 circle, dozen | \$9.30/pk |
| JOR7031XL | 3/8-circle. 3 1/4". Extra heavy needles for bovine and equine use. 12/pk. | \$27.00/pk |

Taper Suture Needles

Choose from a full selection of needles for all veterinary needs. Sizes available include 2, 4, 6, 8, 10, 11, 12, 13, 14, 16, 18 and 20 in 3/8-circle and 1/2-circle models. 12/pk. Price is for (1) 12/pk of one size only. Please specify size when ordering. **Jorvet**

| | | |
|-----------|---|------------|
| JOR6017 | 3/8 circle, dozen | \$9.30/pk |
| JOR6037 | 1/2 circle, dozen | \$9.30/pk |
| JOR6037XL | 3/8-circle. 3 1/4". Extra heavy needles for bovine and equine use. 12/pk. | \$30.00/pk |

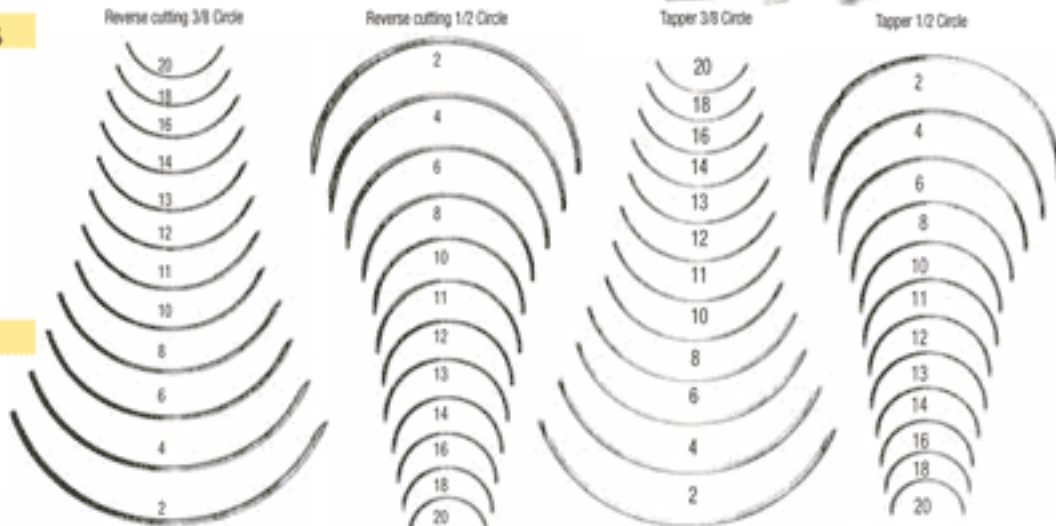

12/pk of one size only
Please specify size when ordering.



12/pk of one size only
Please specify size when ordering.

Heavy Duty Suture Needles

3/8"-curved. Stainless steel. Cutting edge. Length refers to actual length of needle.

| | | |
|-----------|----------------------------|------------|
| JOR110PM4 | 4", 3/8"-curved, 12/pk. | \$18.00/pk |
| JOR110PM3 | 3", 3/8"-curved, 12/pk. | \$18.00/pk |
| JOR110PM5 | 5", 3/8"-curved, 12/pk. | \$18.00/pk |
| JOR110PM6 | 6", 3/8"-curved, 12/pk. | \$18.00/pk |
| JOR110PM | 3/8"-Circle needles, 12/pk | \$18.00 |

12/pk of one size only. Please specify size when ordering.

Jorvet



Half Curved Triangular Suture Needles

| | | |
|-----------|------------------------------|------------|
| JOR110T | Cutting Edge, 12/pk | \$12.00 |
| JOR110T2 | Cutting edge, Size 2, 12/pk | \$12.00/pk |
| JOR110T4 | Cutting edge, Size 4, 12/pk | \$12.00/pk |
| JOR110T6 | Cutting edge, Size 6, 12/pk | \$12.00/pk |
| JOR110T8 | Cutting edge, Size 6, 12/pk | \$12.00/pk |
| JOR110T10 | Cutting edge, Size 10, 12/pk | \$12.00/pk |
| JOR110T12 | Cutting edge, Size 12, 12/pk | \$12.00/pk |
| JOR110T14 | Cutting edge, Size 14, 12/pk | \$12.00/pk |
| JOR110T16 | Cutting edge, Size 16, 12/pk | \$12.00/pk |
| JOR110T18 | Cutting edge, Size 18, 12/pk | \$12.00/pk |
| JOR110T20 | Cutting edge, Size 20, 12/pk | \$12.00/pk |



1/2 Circle Taper Point Needle

12 Per Pack Regular Sargson's Needles, 1/2 circle, taper point

| | | |
|-------------|----------------------|------------|
| MIL-192A-10 | Size 10, 35mm, 12/pk | \$17.34/Pk |
| MIL-192A-12 | Size 12, 29mm, 12/pk | \$17.34/Pk |
| MIL-192A-14 | Size 14, 24mm, 12/pk | \$17.34/Pk |
| MIL-192A-16 | Size 16, 22mm, 12/pk | \$17.34/Pk |
| MIL-192A-18 | Size 18, 18mm, 12/pk | \$17.34/Pk |
| MIL-192A-20 | Size 20, 13mm, 12/pk | \$17.34/Pk |

12 of one size only. Please specify size when ordering.

1/2 Circle Cutting Edge Needle

12 Per Pack Regular Sargson's Needles, 1/2 circle, cutting edge

| | | |
|------------|----------------------|------------|
| MIL-192-10 | Size 10, 35mm, 12/pk | \$17.34/Pk |
| MIL-192-12 | Size 12, 29mm, 12/pk | \$17.34/Pk |
| MIL-192-14 | Size 14, 24mm, 12/pk | \$17.34/Pk |
| MIL-192-16 | Size 16, 22mm, 12/pk | \$17.34/Pk |
| MIL-192-18 | Size 18, 18mm, 12/pk | \$17.34/Pk |
| MIL-192-20 | Size 20, 13mm, 12/pk | \$17.34/Pk |

12 of one size only. Please specify size when ordering.



3/8 Circle Cutting Edge Needle

12 Per Pack Regular Sargson's Needles, 3/8 circle, cutting edge, reverse cutting

| | | |
|------------|----------------------|------------|
| MIL-140-10 | Size 10, 35mm, 12/pk | \$17.34/Pk |
| MIL-140-12 | Size 12, 29mm, 12/pk | \$17.34/Pk |
| MIL-140-14 | Size 14, 24mm, 12/pk | \$17.34/Pk |
| MIL-140-16 | Size 16, 22mm, 12/pk | \$17.34/Pk |
| MIL-140-18 | Size 18, 18mm, 12/pk | \$17.34/Pk |
| MIL-140-20 | Size 20, 13mm, 12/pk | \$17.34/Pk |

12 of one size only. Please specify size when ordering.

3/8 Circle Taper Point Needle

12 Per Pack Regular Sargson's Needles, 3/8 circle, round body, taper point

| | | |
|-------------|----------------------|------------|
| MIL-140A-10 | Size 10, 35mm, 12/pk | \$17.34/Pk |
| MIL-140A-12 | Size 12, 29mm, 12/pk | \$17.34/Pk |
| MIL-140A-14 | Size 14, 24mm, 12/pk | \$17.34/Pk |
| MIL-140A-16 | Size 16, 22mm, 12/pk | \$17.34/Pk |
| MIL-140A-18 | Size 18, 18mm, 12/pk | \$17.34/Pk |
| MIL-140A-20 | Size 20, 13mm, 12/pk | \$17.34/Pk |

12 of one size only. Please specify size when ordering.



SINGLE SUTURE CLOSEOUT

SUBJECT TO AVAILABILITY • USUALLY LESS THAN 24 MONTHS DATING

MONOFILAMENT SYNTHETIC ABSORBABLE

(PDS, Monocryl, Biosyn, Maxon, Caprosyn, PDO) No Choice of Type or Brand.

\$200

| ITEM# | DESCRIPTION | |
|-----------|----------------------------|----------------------------|
| MSA-0-T | Size 0 with Taper Needle | (no choice of needle size) |
| MSA-1-T | Size 1 with Taper Needle | (no choice of needle size) |
| MSA-2-0-T | Size 2-0 with Taper Needle | (no choice of needle size) |
| MSA-3-0-T | Size 3-0 with Taper Needle | (no choice of needle size) |
| MSA-4-0-T | Size 4-0 with Taper Needle | (no choice of needle size) |

\$250

| | | |
|-----------|------------------------------|----------------------------|
| MSA-0-C | Size 0 with Cutting Needle | (no choice of needle size) |
| MSA-1-C | Size 1 with Cutting Needle | (no choice of needle size) |
| MSA-2-0-C | Size 2-0 with Cutting Needle | (no choice of needle size) |
| MSA-3-0-C | Size 3-0 with Cutting Needle | (no choice of needle size) |
| MSA-4-0-C | Size 4-0 with Cutting Needle | (no choice of needle size) |

MONOFILAMENT NON-ABSORBABLE

(Nylon, Polypropylene) No Choice of Type or Brand.

\$100

| ITEM# | DESCRIPTION | |
|----------|------------------------------|----------------------------|
| MN-1-T | Size 1 with Taper Needle | (no choice of needle size) |
| MN-1-C | Size 1 with Cutting Needle | (no choice of needle size) |
| MN-0-T | Size 0 with Taper Needle | (no choice of needle size) |
| MN-0-C | Size 0 with Cutting Needle | (no choice of needle size) |
| MN-2-0-T | Size 2-0 with Taper Needle | (no choice of needle size) |
| MN-2-0-C | Size 2-0 with Cutting Needle | (no choice of needle size) |
| MN-3-0-T | Size 3-0 with Taper Needle | (no choice of needle size) |
| MN-3-0-C | Size 3-0 with Cutting Needle | (no choice of needle size) |
| MN-4-0-C | Size 4-0 with Cutting Needle | (no choice of needle size) |

\$200

| | | |
|----------|------------------------------|----------------------------|
| MN-5-0-T | Size 5-0 with Taper Needle | (no choice of needle size) |
| MN-5-0-C | Size 5-0 with Cutting Needle | (no choice of needle size) |
| MN-6-0-C | Size 6-0 with Cutting Needle | (no choice of needle size) |
| MN-6-0-T | Size 6-0 with Taper Needle | (no choice of needle size) |

BRAIDED NON-ABSORBABLE

(Mixed Silk, Ethibond, Surgidac, Ti-Cron, Mersilene, Sofsilik, etc.) No Choice of Type or Brand.

\$100

| ITEM# | DESCRIPTION | |
|------------|------------------------------|----------------------------|
| BRAD-2-0-C | Size 2-0 with Cutting Needle | no choice of needle size) |
| BRAD-3-0-C | Size 3-0 with Cutting Needle | no choice of needle size) |
| BRAD-4-0-C | Size 4-0 with Cutting Needle | (no choice of needle size) |
| BRAD-5-0-C | Size 5-0 with Cutting Needle | (no choice of needle size) |

We have outdated suture available in their original packaging. Great for teaching or research. We sell them as non-sterile and for veterinary use only. Inquire for type, specific sizes and pricing. Letter of acknowledgement is required.

13822 WEST BOULTON BLVD. METTAWA, IL 60045

WWW.SHOPMEDVET.COM

Phone 800-544-7521

52

Fax 800-204-2177

SINGLE SUTURE CLOSEOUT

SUBJECT TO AVAILABILITY • USUALLY LESS THAN 24 MONTHS DATING

MONOFILAMENT SYNTHETIC ABSORBABLE

(PDS, Monocryl, Biosyn, Maxon, Caprosyn, PDO) No Choice of Type or Brand.

\$200

| ITEM# | DESCRIPTION | |
|-----------|----------------------------|----------------------------|
| MSA-0-T | Size 0 with Taper Needle | (no choice of needle size) |
| MSA-1-T | Size 1 with Taper Needle | (no choice of needle size) |
| MSA-2-0-T | Size 2-0 with Taper Needle | (no choice of needle size) |
| MSA-3-0-T | Size 3-0 with Taper Needle | (no choice of needle size) |
| MSA-4-0-T | Size 4-0 with Taper Needle | (no choice of needle size) |

\$250

| | | |
|-----------|------------------------------|----------------------------|
| MSA-0-C | Size 0 with Cutting Needle | (no choice of needle size) |
| MSA-1-C | Size 1 with Cutting Needle | (no choice of needle size) |
| MSA-2-0-C | Size 2-0 with Cutting Needle | (no choice of needle size) |
| MSA-3-0-C | Size 3-0 with Cutting Needle | (no choice of needle size) |
| MSA-4-0-C | Size 4-0 with Cutting Needle | (no choice of needle size) |

MONOFILAMENT NON-ABSORBABLE

(Nylon, Polypropylene) No Choice of Type or Brand.

\$100

| ITEM# | DESCRIPTION | |
|----------|------------------------------|----------------------------|
| MN-1-T | Size 1 with Taper Needle | (no choice of needle size) |
| MN-1-C | Size 1 with Cutting Needle | (no choice of needle size) |
| MN-0-T | Size 0 with Taper Needle | (no choice of needle size) |
| MN-0-C | Size 0 with Cutting Needle | (no choice of needle size) |
| MN-2-0-T | Size 2-0 with Taper Needle | (no choice of needle size) |
| MN-2-0-C | Size 2-0 with Cutting Needle | (no choice of needle size) |
| MN-3-0-T | Size 3-0 with Taper Needle | (no choice of needle size) |
| MN-3-0-C | Size 3-0 with Cutting Needle | (no choice of needle size) |
| MN-4-0-C | Size 4-0 with Cutting Needle | (no choice of needle size) |

\$200

| | | |
|----------|------------------------------|----------------------------|
| MN-5-0-T | Size 5-0 with Taper Needle | (no choice of needle size) |
| MN-5-0-C | Size 5-0 with Cutting Needle | (no choice of needle size) |
| MN-6-0-C | Size 6-0 with Cutting Needle | (no choice of needle size) |
| MN-6-0-T | Size 6-0 with Taper Needle | (no choice of needle size) |

BRAIDED NON-ABSORBABLE

(Mixed Silk, Ethibond, Surgidac, Ti-Cron, Mersilene, Sofsilik, etc.) No Choice of Type or Brand.

\$100

| ITEM# | DESCRIPTION | |
|------------|------------------------------|----------------------------|
| BRAD-2-0-C | Size 2-0 with Cutting Needle | no choice of needle size) |
| BRAD-3-0-C | Size 3-0 with Cutting Needle | no choice of needle size) |
| BRAD-4-0-C | Size 4-0 with Cutting Needle | (no choice of needle size) |
| BRAD-5-0-C | Size 5-0 with Cutting Needle | (no choice of needle size) |

We have outdated suture available in their original packaging. Great for teaching or research. We sell them as non-sterile and for veterinary use only. Inquire for type, specific sizes and pricing. Letter of acknowledgement is required.

13822 WEST BOULTON BLVD. METTAWA, IL 60045

WWW.SHOPMEDVET.COM

Phone 800-544-7521

52

Fax 800-204-2177

Syringes & Needles



Disposable Syringes & Needles



- Sharp Siliconized Needle
- Individual Soft Pack
- Bold Graduation
- Latex Free
- ISO-9002, CE
- FDA registered



MVI Insulin & T.B. Syringe

| | | | | |
|---------|-------------------------------|-----------|-------------|-------------|
| MV1CCLS | 1cc L/S, Syringe only, 100/bx | \$7.99/bx | 10+\$6.99ea | 20+\$5.99ea |
|---------|-------------------------------|-----------|-------------|-------------|

MVI Insulin & T.B. Syringe & Needle

| | | | | |
|-------------|--------------------------------|-----------|-------------|-------------|
| MV1CC25X5/8 | 1cc 25g x 5/8", T.B. 100/bx | \$8.99/bx | 10+\$7.99ea | 20+\$6.99ea |
| MV1CC27X1/2 | 1cc 27g x 1/2", T.B. 100/bx | \$8.99/bx | 10+\$7.99ea | 20+\$6.99ea |
| MV1CCINS | 1cc 28g x 1/2", insulin 100/bx | \$8.99/bx | 10+\$7.99ea | 20+\$6.99ea |

MVI Syringes

| | | | | |
|-----------|--------------------------------|------------|-------------|-------------|
| MV3CCLL | 3cc L/L 100/bx | \$6.99/bx | 10+\$5.99ea | 20+\$4.99ea |
| MV3CCLS | 3cc L/S 100/bx | \$6.99/bx | 10+\$5.99ea | 20+\$4.99ea |
| MV5CCLL | 5cc L/L 100/bx | \$8.99/bx | 10+\$7.99ea | 20+\$6.99ea |
| MV5CCLS | 5cc L/S 100/bx | \$8.99/bx | 10+\$7.99ea | 20+\$6.99ea |
| MV10CCLL | 10cc L/L 100/bx | \$10.99/bx | | |
| MV10CCLS | 10cc L/S 100/bx | \$10.99/bx | | |
| MV20CCELS | 20cc Eccentric Luer Slip 50/bx | \$14.95/bx | | |
| MV20CCLL | 20cc L/L 50/bx | \$14.95/bx | | |
| MV30CCELS | 30cc Eccentric Luer Slip 30/bx | \$9.99/bx | | |
| MV30CCLL | 30cc L/L 30/bx | \$9.99/bx | | |
| MV60CCCT | 60cc Catheter Tip 25/bx | \$9.99/bx | 10+\$8.99ea | 20+\$7.99ea |
| MV60CCELS | 60cc Eccentric Luer Slip 25/bx | \$9.99/bx | 10+\$8.99ea | 20+\$7.99ea |
| MV60CCLL | 60cc L/L 25/bx | \$9.99/bx | 10+\$8.99ea | 20+\$7.99ea |

MVI Syringe & Needle

| | | | | |
|---------------|------------------------------|-----------|-------------|-------------|
| MV3CC20X1L | 3cc 20g x 1", L/L 100/bx | \$6.99/bx | 10+\$5.99ea | 20+\$4.99ea |
| MV3CC20X1.5L | 3cc 20g x 1 1/2", L/L 100/bx | \$6.99/bx | 10+\$5.99ea | 20+\$4.99ea |
| MV3CC21X1L | 3cc 21g x 1", L/L 100/bx | \$6.99/bx | 10+\$5.99ea | 20+\$4.99ea |
| MV3CC22X3/4L | 3cc 22g x 3/4", L/L 100/bx | \$6.99/bx | 10+\$5.99ea | 20+\$4.99ea |
| MV3CC22X1L | 3cc 22g x 1", L/L 100/bx | \$6.99/bx | 10+\$5.99ea | 20+\$4.99ea |
| MV3CC22X1.5L | 3cc 22g x 1 1/2", L/L 100/bx | \$6.99/bx | 10+\$5.99ea | 20+\$4.99ea |
| MV3CC22X3/4S | 3cc 22g x 3/4", L/S 100/bx | \$6.99/bx | 10+\$5.99ea | 20+\$4.99ea |
| MV3CC23X1L | 3cc 23g x 1", L/L 100/bx | \$6.99/bx | 10+\$5.99ea | 20+\$4.99ea |
| MV3CC25X5/8L | 3cc 25g x 5/8", L/L 100/bx | \$6.99/bx | 10+\$5.99ea | 20+\$4.99ea |
| MV3CC25X1.25L | 3cc 25g x 1.25", L/L 100/bx | \$6.99/bx | 10+\$5.99ea | 20+\$4.99ea |
| MV3CC27X1.25L | 3cc 27g x 1.25", L/L 100/bx | \$6.99/bx | 10+\$5.99ea | 20+\$4.99ea |

MVI Polyhub Needles

| | | | | |
|-----------|--------------------|-----------|-------------|-------------|
| MVN18X1 | 18 x 1, 100/bx | \$3.99/bx | 10+\$3.49ea | 20+\$2.99ea |
| MVN18X1.5 | 18 x 1, 1/2 100/bx | \$3.99/bx | 10+\$3.49ea | 20+\$2.99ea |
| MVN20X1 | 20 x 1, 100/bx | \$3.99/bx | 10+\$3.49ea | 20+\$2.99ea |
| MVN20X1.5 | 20 x 1, 1/2 100/bx | \$3.99/bx | 10+\$3.49ea | 20+\$2.99ea |
| MVN21X1 | 21 x 1, 100/bx | \$3.99/bx | 10+\$3.49ea | 20+\$2.99ea |
| MVN22X1 | 22 x 1, 100/bx | \$3.99/bx | 10+\$3.49ea | 20+\$2.99ea |
| MVN22X1.5 | 22 x 1, 1/2 100/bx | \$3.99/bx | 10+\$3.49ea | 20+\$2.99ea |
| MVN22X3/4 | 22 x 3/4, 100/bx | \$3.99/bx | 10+\$3.49ea | 20+\$2.99ea |
| MVN23X1 | 23 x 1, 100/bx | \$3.99/bx | 10+\$3.49ea | 20+\$2.99ea |
| MVN25X1 | 25 x 1, 100/bx | \$3.99/bx | 10+\$3.49ea | 20+\$2.99ea |
| MVN25X1.5 | 25 x 1, 1/2 100/bx | \$3.99/bx | 10+\$3.49ea | 20+\$2.99ea |
| MVN25X5/8 | 25 x 5/8, 100/bx | \$3.99/bx | 10+\$3.49ea | 20+\$2.99ea |

13822 WEST BOULTON BLVD. METTAWA, IL 60045

Phone 800-544-7521

54

WWW.SHOPMEDVET.COM

Fax 800-204-2177

Monoject BLOWOUT

FOR A LIMITED TIME WHILE SUPPLIES LAST!!!

Monoject SYRINGES

1/2cc & 1cc SOFTPACK

| | | |
|---------|---------------------------------|---------|
| 127012 | 1CC 27X1/2, T.B., 100/BX | \$14.95 |
| 128012 | 1CC 28 X 1/2" TB, 100/BX | \$14.95 |
| 8528012 | 1/2CC 28 X 1/2" INSULIN, 100/BX | \$14.95 |

1/2cc & 1cc Hard Pack SYRINGES

| | | |
|--------|----------------------------------|---------|
| 500014 | 1/2CC 28 X 1/2, INS, 100/BX | \$14.95 |
| 501160 | 1CC 25X5/8, T.B., 100/BX | \$16.95 |
| 501178 | 1CC 26 X 3/8, T.B., 100/BX | \$14.95 |
| 501210 | 1CC 28 X 1/2, INS, 100/BX | \$14.95 |
| 501368 | 1CC 27X1/2, T.B., 100/BX | \$14.95 |
| 501400 | 1CC TB, L/S, 100/BX | \$11.95 |
| 501442 | 1CC 27 x1/2 U-40 INSULIN, 100/BX | \$9.95 |
| 501608 | 1CC 28 X 1/2, TB, 100/BX | \$9.95 |

Soft pack INSULIN SYRINGES

| | | |
|--------|--------------------------------------|---------|
| 600350 | 1/2CC 29 X 1/2, U-100 INSULIN 100/BX | \$14.95 |
| 600848 | 1/2CC 29 X 1/2, U-100 INSULIN 100/BX | \$14.95 |

3CC Luer Slip Vet Pack SYRINGES

| | | |
|--------|--------------------------------------|--------|
| 503406 | 3CC 20 X 1, L/S VET PACK, 100/BX | \$9.95 |
| 503422 | 3CC 21 X 1, L/S VET PACK, 100/BX | \$9.95 |
| 503430 | 3CC 20 X 1 1/2, L/S VET PACK, 100/BX | \$9.95 |
| 503448 | 3CC 22 X 3/4, L/S VET PACK, 100/BX | \$9.95 |
| 503455 | 3CC 22 X 1, L/S VET PACK, 100/BX | \$9.95 |
| 503463 | 3CC 22 X 1 1/2, L/S VET PACK, 100/BX | \$9.95 |
| 503489 | 3CC 25 X 5/8, L/S VET PACK, 100/BX | \$9.95 |

3cc Luer Lock Vet Pack SYRINGES

| | | |
|--------|---|--------|
| 505025 | 3CC 20 X 3/4, VET PACK, 100/BX | \$9.95 |
| 505033 | 3CC 20 X 1, VET PACK, 100/BX | \$9.95 |
| 505058 | SYRINGE, 3CC 20 X 1 1/2, VET PACK, 100/BX | \$9.95 |
| 505132 | 3CC 21 X 1, VET PACK, 100/BX | \$9.95 |
| 505223 | 3CC 22 X 3/4, VET PACK, 100/BX | \$9.95 |
| 505231 | 3CC 22 X 1, VET PACK, 100/BX | \$9.95 |
| 505330 | 3CC 23 X 1, VET PACK, 100/BX | \$9.95 |
| 505512 | 3CC 25 X 5/8, VET PACK, 100/BX | \$9.95 |
| 505538 | 3CC 25 X 1, VET PACK, 100/BX | \$9.95 |

3cc Hard Pack SYRINGES

| | | |
|--------|----------------------|---------|
| 513025 | 3CC 20 X 3/4, 100/BX | \$10.95 |
| 513033 | 3CC 20 X 1, 100/BX | \$10.95 |

3cc HARD PACK SYRINGES

| | | |
|--------|-----------------------------|---------|
| 513058 | 3CC 20 X 1 1/2, 100/BX | \$10.95 |
| 513132 | 3CC 21 X 1, 100/BX | \$10.95 |
| 513157 | 3CC 21 X 1 1/2, L/L, 100/BX | \$10.95 |
| 513223 | 3CC 22 X 3/4, L/L, 100/BX | \$10.95 |
| 513231 | 3CC 22 X 1, L/L, 100/BX | \$10.95 |
| 513256 | 3CC 22 X 1 1/2, 100/BX | \$10.95 |
| 513512 | 3CC 25 X 5/8, 100/BX | \$10.95 |
| 513744 | 3CC 27 X 1 1/4, 100/BX | \$10.95 |
| 513918 | 3CC L/S, 100/BX | \$7.95 |
| 513934 | 3CC LL, 100/BX | \$13.50 |

6cc Soft Pack SYRINGES

| | | |
|--------|---------------------|---------|
| 621100 | 6CC 21 X 1", 100/BX | \$25.70 |
|--------|---------------------|---------|

6cc Hard Pack SYRINGES

| | | |
|--------|-----------------------|---------|
| 516051 | 6CC 20 X 1 1/2, 50/BX | \$11.95 |
| 516135 | 6CC 21 X 1, 50/BX | \$9.95 |
| 516150 | 6CC 21 X 1 1/2, 50/BX | \$9.95 |

12cc Soft Pack SYRINGE W/NEEDLE

| | | |
|--------|------------------------|--------|
| 221100 | 12CC 21 X 1 L/L, 80/BX | \$9.95 |
|--------|------------------------|--------|

12cc Hard Pack SYRINGES

| | | |
|--------|--------------------|---------|
| 512597 | 12CC 18 X 1, 80/BX | \$19.95 |
| 512738 | 12CC 21 X 1, 80/BX | \$19.95 |

20cc Hard Pack SYRINGES

| | | |
|--------|-------------------------|---------|
| 520657 | 20CC L/L, 50/BX | \$19.95 |
| 520673 | 20CC L/S, 50/BX | \$19.95 |
| | 35CC HARD PACK SYRINGES | |

- One step peel-away package for quick/easy opening
- Convenient, individually packaged inner cartons.
- Brilliant color-coded needle gauge stripe
- New and improved needle lubricant
- Clear barrel construction and bolder
- 3cc syringe features extended finger flanges and a longer plunger rod for greater control
- New syringe tip caps included on each syringe.



Hurry, When They're Gone They're Gone!

13822 WEST BOULTON BLVD. METTAWA, IL 60045

Phone 800-544-7521

55

WWW.SHOPMEDVET.COM

Fax 800-204-2177

Monoject BLOWOUT

FOR A LIMITED TIME WHILE SUPPLIES LAST!!!

Monoject SAFETY SYRINGES

3cc Safety SYRINGES

| | | |
|--------|--------------------------------|---------|
| 533056 | 3CC 20 X 1 1/2, SAFETY, 100/BX | \$14.95 |
| 533130 | 3CC 21 X 1, SAFETY, 100/BX | \$14.95 |
| 533155 | 3CC 21 X 1 1/2, SAFETY, 100/BX | \$14.95 |
| 533239 | 3CC 22 X 1, SAFETY, 100/BX | \$14.95 |
| 533254 | 3CC 22 X 1 1/2, SAFETY, 100/BX | \$14.95 |
| 533338 | 3CC 23 X 1, SAFETY, 100/BX | \$14.95 |
| 533510 | 3CC 25 X 5/8, SAFETY, 100/BX | \$14.95 |
| 533908 | 3CC L/L, SAFETY, 100/BX | \$14.95 |

6CC Safety SYRINGES

| | | |
|--------|----------------------------------|---------|
| 566007 | 6CC L/L, SAFETY, 50/BX | \$14.95 |
| 566023 | 6CC 21X1 1/2, L/L, SAFETY, 50/BX | \$14.95 |

12CC SAFETY SYRINGES

| | | |
|--------|--------------------------------|---------|
| 522000 | 12CC L/L, SAFETY, 50/BX | \$9.95 |
| 522018 | 12CC 20 X 1 1/2, SAFETY, 50/BX | \$14.95 |
| 522026 | 12CC 21 X 1 1/2, SAFETY, 50/BX | \$14.95 |

Monoject Magellan Safety SYRINGE & NEEDLE COMBINATIONS

1CC Magellan Safety SYRINGES

| | | |
|--------|---|---------|
| 811510 | 1CC 25 X 1, MAGELLAN SAFETY, 50/BX | \$14.95 |
| 811558 | 1CC 25 X 5/8, MAGELLAN SAFETY, 50/BX | \$14.95 |
| 882812 | 1CC 28 X 1/2, TB, MAGELLAN SAFETY, 50/BX | \$14.95 |
| 892910 | 1CC 29 X 1/2, INSULIN, MAGELLAN SAFETY, 50/BX | \$14.95 |
| 892950 | 1CC 29 X 1/2, INSULIN, MAGELLAN SAFETY, 50/BX | \$14.95 |

3CC Magellan Safety SYRINGES

| | | |
|--------|--|---------|
| 833010 | 3CC 20 X 1, MAGELLAN SAFETY, 50/BX | \$14.95 |
| 833015 | 3CC 20 X 1 1/2, MAGELLAN SAFETY, 50/BX | \$14.95 |
| 833110 | 3CC 21 X 1, MAGELLAN SAFETY, 50/BX | \$14.95 |
| 833115 | 3CC 21 X 1 1/2, MAGELLAN SAFETY, 50/BX | \$14.95 |
| 833210 | 3CC 22 X 1, MAGELLAN SAFETY, 50/BX | \$14.95 |
| 833215 | 3CC 22 X 1 1/2, MAGELLAN SAFETY, 50/BX | \$14.95 |
| 833310 | 3CC 23 X 1, MAGELLAN SAFETY, 50/BX | \$14.95 |
| 833510 | 3CC 25 X 1, MAGELLAN SAFETY, 50/BX | \$14.95 |

3CC Magellan Safety SYRINGES

| | | |
|--------|--------------------------------------|---------|
| 833558 | 3CC 25 X 5/8, MAGELLAN SAFETY, 50/BX | \$14.95 |
| 833810 | 3CC 18 X 1, MAGELLAN SAFETY, 50/BX | \$14.95 |

6CC Magellan Safety SYRINGES

| | | |
|--------|--|---------|
| 866015 | 6CC 20 X 1 1/2, MAGELLAN SAFETY, 50/BX | \$14.95 |
| 866110 | 6CC 21 X 1, MAGELLAN SAFETY, 50/BX | \$14.95 |
| 866115 | 6CC 21 X 1 1/2, MAGELLAN SAFETY, 50/BX | \$14.95 |
| 866810 | 6CC 18 X 1, MAGELLAN SAFETY, 50/BX | \$14.95 |

12cc Magellan Safety SYRINGES

| | | |
|--------|---|---------|
| 822015 | 12CC 20 X 1 1/2, MAGELLAN SAFETY, 50/BX | \$14.95 |
| 822115 | 12CC 21 X 1 1/2, MAGELLAN SAFETY, 50/BX | \$14.95 |
| 822810 | 12CC 18 X 1, MAGELLAN SAFETY, 50/BX | \$14.95 |

Feeding SYRINGES

| | | |
|--------|-----------------------------|---------|
| 906005 | FEEDING, 6ML AMBER, 100/BX | \$19.95 |
| 906104 | FEEDING, 6ML CLEAR, 100/BX | \$19.19 |
| 907003 | FEEDING, 10ML AMBER, 100/BX | \$14.95 |
| 907102 | FEEDING, 10ML CLEAR, 100/BX | \$22.99 |

Magellan™ safety needle and syringe combinations are needle based safety devices preattached to syringes that protect the healthcare worker from accidental needlestick injuries. The preattached combinations save valuable nursing time and improve clinical efficiencies.



 COVIDIEN

Hurry, When They're Gone They're Gone!

13822 WEST BOULTON BLVD. METTAWA, IL 60045

Phone 800-544-7521

56

WWW.SHOPMEDVET.COM

Fax 800-204-2177

Monoject **BLOWOUT**

FOR A LIMITED TIME WHILE SUPPLIES LAST!!!

Monoject **NEEDLES**

Soft Pack **NEEDLES**

| | | |
|-------|--------------------|--------|
| 18100 | 18 X 1, 100/BX | \$6.95 |
| 18112 | 18 X 1 1/2, 100/BX | \$6.95 |
| 19100 | 19 X 1, 100/BX | \$6.95 |
| 20100 | 20 X 1, 100/BX | \$6.95 |
| 27112 | 27 X 1 1/2, 100/BX | \$6.95 |

250 Series Hard Pack **NEEDLES**

| | | |
|--------|--------------------|--------|
| 250016 | 18 X 1 1/2, 100/BX | \$5.95 |
| 250040 | 18 X 1, 100/BX | \$5.95 |
| 250065 | 19 X 1 1/2, 100/BX | \$5.95 |
| 250081 | 19 X 1, 100/BX | \$5.95 |
| 250206 | 22 X 1 1/2, 100/BX | \$5.95 |
| 250255 | 23 X 1, 100/BX | \$5.95 |
| 250313 | 25 X 5/8, 100/BX | \$5.95 |
| 250545 | 25 X 1 1/2, 100/BX | \$5.95 |

Veterinary Hard Pack **NEEDLES**

| | | |
|--------|-----------------------------|--------|
| 251709 | 18 X 1, VET PAK, 100/BX | \$5.95 |
| 251725 | 18 X 1 1/2, VET PAK, 100/BX | \$5.95 |
| 251741 | 19 X 1 1/2, VET PAK, 100/BX | \$5.95 |
| 251774 | 20 X 3/4, VET PAK, 100/BX | \$5.95 |
| 251782 | 20 X 1, VET PAK, 100/BX | \$5.95 |
| 251790 | 20 X 1 1/2, VET PAK, 100/BX | \$5.95 |
| 251840 | 21 X 1, VET PAK, 100/BX | \$5.95 |
| 251865 | 22 X 3/4, VET PAK, 100/BX | \$5.95 |
| 251881 | 22 X 1, VET PAK, 100/BX | \$5.95 |
| 251907 | 25 X 5/8, VET PAK, 100/BX | \$5.95 |

Filter **NEEDLES**

| | | |
|--------|----------------------------|--------|
| 305018 | FILTER, 20 X 1 1/2, 100/BX | \$9.95 |
| 305117 | FILTER, 18 X 1 1/2, 100/BX | \$9.95 |

Magellan Safety **NEEDLES**

| | | |
|--------|-----------------------------------|--------|
| 850010 | 20 X 1 MAGELLAN SAFETY, 50/BX | \$7.95 |
| 850015 | 20 X 1 1/2 MAGELLAN SAFETY, 50/BX | \$7.95 |
| 850110 | 21 X 1 MAGELLAN SAFETY, 50/BX | \$7.95 |
| 850115 | 21 X 1 1/2 MAGELLAN SAFETY, 50/BX | \$7.95 |
| 850158 | 21 X 5/8 MAGELLAN SAFETY, 50/BX | \$7.95 |

Magellan Safety **NEEDLES**

| | | |
|--------|-----------------------------------|--------|
| 850210 | 22 X 1 MAGELLAN SAFETY, 50/BX | \$7.95 |
| 850215 | 22 X 1 1/2 MAGELLAN SAFETY, 50/BX | \$7.95 |
| 850310 | 23 X 1 MAGELLAN SAFETY, 50/BX | \$7.95 |
| 850510 | 25 X 1 MAGELLAN SAFETY, 50/BX | \$7.95 |
| 850558 | 25 X 5/8, MAGELLAN SAFETY, 50/BX | \$7.95 |
| 850810 | 18 X 1, SAFETY MAGELLAN 50/BX | \$7.95 |
| 850815 | 18 X 1 1/2, SAFETY MAGELLAN 50/BX | \$7.95 |
| 850910 | 19 X 1, SAFETY MAGELLAN 50/BX | \$7.95 |
| 850915 | 19 X 1 1/2, SAFETY MAGELLAN 50/BX | \$7.95 |

200 Series Aluminum Hub **NEEDLES**

| | | |
|--------|---|---------|
| 200060 | 16 X 3/4, ALUM.HUB, 100/BX | \$14.95 |
| 200086 | 18 X 1 1/2, SHORT BEVEL, ALUM HUB, 100/BX | \$9.95 |
| 200227 | 20 X 1, SHORT BEVEL, ALUM HUB, 100/BX | \$9.95 |
| 200573 | 14 X 2, ALUM HUB, 100/BX | \$14.95 |
| 200714 | 18 X 1, ALUM HUB, 100/BX | \$9.95 |

201 Series Veterinary Aluminum Hub **NEEDLES**

| | | |
|--------|------------------------------|---------|
| 201407 | 27X 1/4, ALUM HUB, 100/BX | \$12.95 |
| 201449 | 22X 1, ALUM HUB, 100/BX | \$12.95 |
| 201456 | 22X 1 1/2, ALUM HUB, 100/BX | \$12.95 |
| 201480 | 20X 1, ALUM HUB, 100/BX | \$12.95 |
| 201498 | 20 X 1 1/2, ALUM HUB, 100/BX | \$12.95 |
| 201530 | 18 X 1, ALUM HUB, 100/BX | \$12.95 |
| 201563 | 20X 1, ALUM HUB, 100/BX | \$12.95 |
| 201647 | 16 X 1, ALUM HUB, 100/BX | \$12.95 |
| 201670 | 16 X 3/4, ALUM HUB, 100/BX | \$12.95 |
| 201688 | 14 X 1, ALUM HUB, 100/BX | \$14.95 |
| 201696 | 14 X 1 1/2, ALUM HUB, 100/BX | \$14.95 |
| 201720 | 18 X 3/4, ALUM HUB, 100/BX | \$9.95 |

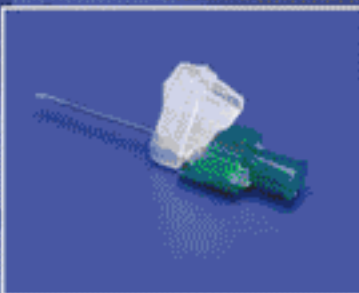

Magellan™ safety needles are needle based safety devices that protect the healthcare worker from accidental needle-stick injuries.

 **COVIDIEN**

Hurry, When They're Gone They're Gone!

13822 WEST BOULTON BLVD. METTAWA, IL 60045

Phone 800-544-7521

57

WWW.SHOPMEDVET.COM

Fax 800-204-2177

Syringes & Needles

Vet-Syringe & Terumo

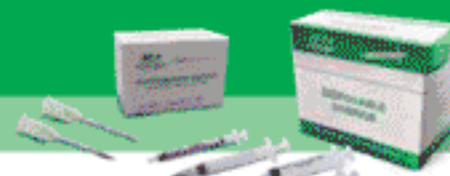

VET-SYRINGE



SYRINGES AND NEEDLES

| | | |
|-------------|--------------------------------------|-----------|
| 1cc | | |
| 1CC25X5/8VS | 1cc 25g x 5/8", Vet Use, T.B. 100/bx | \$6.99/bx |

| | | |
|-------------|---------------------------------------|-----------|
| 3cc | | |
| 3CC20X1.5VL | 3cc 20g x 1 1/2", Vet Use, L/L 100/bx | \$5.99/bx |
| 3CC20X1VL | 3cc 20g x 1", Vet Use, L/L 100/bx | \$5.99/bx |
| 3CC22X1VL | 3cc 22g x 1", Vet Use, L/L 100/bx | \$5.99/bx |
| 3CC22X3/4VL | 3cc 22g x 3/4", Vet Use, L/L 100/bx | \$5.99/bx |
| 3CC25X5/8VL | 3cc 25g x 5/8", Vet Use, L/L 100/bx | \$5.99/bx |
| 3CC22X3/4VS | 3cc 22g x 3/4", Vet Use, L/S 100/bx | \$5.99/bx |

SYRINGES ONLY

| | | |
|-------------|--|------------|
| 1cc | | |
| 1CCVLS | 1cc L/S, Syringe only, Vet use, 100/bx | \$5.99/bx |
| 3cc | | |
| 3CCVLL | 3cc L/L, Syringe only, Vet use, 100/bx | \$4.99/bx |
| 3CCVLS | 3cc L/S, Syringe only, Vet use, 100/bx | \$4.99/bx |
| 5cc | | |
| 5CCVLL | 5cc L/L, Syringe only, Vet use, 100/bx | \$6.99/bx |
| 5CCVLS | 5cc L/S, Syringe only, Vet use, 100/bx | \$6.99/bx |
| 10cc | | |
| 10CCVLL | 10cc L/L, Syringe only, Vet use, 100/bx | \$9.99/bx |
| 10CCVLS | 10cc L/S, Syringe only, Vet use, 100/bx | \$9.99/bx |
| 20cc | | |
| 20CCVELS | 20cc eccentric L/S, Syringe only, Vet use, 50/bx | \$11.99/bx |
| 20CCVLL | 20cc L/L, Syringe only, Vet use, 50/bx | \$11.99/bx |
| 30cc | | |
| 30CCVELS | 30cc Eccentric L/S 30/bx | \$8.99/bx |
| 30CCVLL | 30cc L/L 30/bx | \$8.99/bx |
| 60cc | | |
| 60CCVELS | 60cc eccentric L/S, Syringe only, Vet use, 25/bx | \$8.99/bx |
| 60CCVCT | 60cc catheter tip, Syringe only, Vet use, 25/bx | \$8.99/bx |
| 60CCVLL | 60cc luer lock, Syringe only, Vet use, 25/bx | \$8.99/bx |

Terumo Syringe & Needle Combo



Insulin & T.B.

| | | |
|---------|---------------------------------|------------|
| 05M2813 | 1/2cc 28x1/2 insulin 100/bx | \$11.95/bx |
| 01T | 1cc L/S, T.B. 100/bx | \$9.95/bx |
| 01T2516 | 1cc 25g x 5/8" T.B. 100/bx | \$12.95/bx |
| 01T2713 | 1cc 27g x 1/2" T.B. 100/bx | \$12.95/bx |
| 05M2913 | 1/2cc 29g x 1/2" insulin 100/bx | \$11.95/bx |
| 10M2813 | 1cc 28g x 1/2" insulin 100/bx | \$11.95/bx |

| | | |
|------------|--------------------------|-----------|
| 3cc | | |
| 03L2025 | 3cc 20g x 1", 100/bx | \$9.50/bx |
| 03L2038 | 3cc 20g x 1 1/2", 100/bx | \$9.50/bx |
| 03L2125 | 3cc 21g x 1", 100/bx | \$9.50/bx |
| 03L2225 | 3cc 22g x 1", 100/bx | \$9.50/bx |
| 03L2238 | 3cc 22g x 1 1/2", 100/bx | \$9.50/bx |
| 03L2325 | 3cc 23g x 1", 100/bx | \$9.50/bx |
| 03L2338 | 3cc 23g x 1.5", 100/bx | \$9.50/bx |
| 03L2516 | 3cc 25g x 5/8", 100/bx | \$9.50/bx |
| 03L2525 | 3cc 25g x 1", 100/bx | \$9.50/bx |

Featuring SureVet Needles

| | | |
|--------|----------------------------------|-----------|
| 100098 | 3cc 22g x 1" SurVet L/S 100/bx | \$9.50/bx |
| 100276 | 3cc 22g x 3/4" SurVet L/L 100/bx | \$9.50/bx |
| 100278 | 3cc 25g x 5/8" SurVet L/L 100/bx | \$9.50/bx |
| 100103 | 3cc 25g x 5/8" SurVet L/S 100/bx | \$9.50/bx |

Terumo SurVet Needle

| | | |
|--------|-------------------------|-----------|
| 100279 | 22g x 3/4 Terumo 100/bx | \$5.95/bx |
|--------|-------------------------|-----------|

Terumo Syringes



Assorted Sizes

| | | |
|------|-------------------------|------------|
| 03L | 3cc L/L 100/bx | \$8.95/bx |
| 03S | 3cc L/S 100/bx | \$8.95/bx |
| 05L | 5cc L/L 100/bx | \$8.95/bx |
| 05S | 5cc L/S 100/bx | \$13.50/bx |
| 10L | 10cc L/L 100/bx | \$13.95/bx |
| 10S | 10cc L/S 100/bx | \$13.95/bx |
| 30S | 30cc L/S 25/bx | \$10.95/bx |
| 60L | 60cc L/L 25/bx | \$15.95/bx |
| 60ES | 60cc Ecc Tip 25/bx | \$15.95/bx |
| 20L2 | 20cc L/L 50/bx | \$17.95/bx |
| 60C | 60cc Catheter Tip 25/bx | \$15.95/bx |
| 20S2 | 20cc L/S 50/bx | \$17.95/bx |

Terumo Needles

| | | |
|--------|---------------------|-----------|
| 1838RN | 18g x 1.5" 100/bx | \$5.95/bx |
| 1825RN | 18g x 1" 100/bx | \$5.95/bx |
| 1925RN | 19g x 1" 100/bx | \$5.95/bx |
| 2025RN | 20g x 1" 100/bx | \$5.95/bx |
| 2038RN | 20g x 1.5", 100/bx | \$5.95/bx |
| 2125RN | 21g x 1" 100/bx | \$5.95/bx |
| 2225RN | 22g x 1" 100/bx | \$5.95/bx |
| 2238RN | 22g x 1.5" 100/bx | \$5.95/bx |
| 2325RN | 23g x 1" 100/bx | \$5.95/bx |
| 2525RN | 25g x 1" 100/bx | \$5.95/bx |
| 2516RN | 25g x 5/8" 100/bx | \$5.95/bx |
| 2538RN | 25g x 1 1/2" 100/bx | \$5.95/bx |



13822 WEST BOULTON BLVD. METTAWA, IL 60045

Phone 800-544-7521

58

WWW.SHOPMEDVET.COM

Fax 800-204-2177

Syringes & Needles

Ulticare & Excel

Ulticare Veterinary U40 Insulin Syringe

Inside Ulticare's innovative Dispense and Dispose container you'll find 100 premium quality U40 insulin syringes. All for less than a box of the leading syringe.

| | | |
|-------|--------------------------------------|-------------|
| 07260 | 0.5cc, 29g, 1/2 inch needle, 100/box | \$19.99/box |
| 07261 | 1.0cc, 29g, 1/2 inch needle, 100/box | \$19.99/box |



U40 Insulin Syringe

| | | |
|-----------|--------------------------------------|------------|
| ISU400529 | 0.5cc, 29g, 1/2 inch needle, 100/box | \$9.95/box |
| ISU401029 | 1cc, 29g, 1/2 inch needle, 100/box | \$9.95/box |



- Latex Free Products
- Non-Toxic
- Sterile & Non-Pyrogenic
- Positive Plunger stop to prevent spillage when drawing
- Smooth plunger motion
- Polypropylene construction



Exel 3cc Syringe with Needle

| | | |
|-------|------------------------------|------------|
| 26100 | 3cc, 25g x 5/8", LL, 100/box | \$7.99/box |
| 26102 | 3cc, 22g x 1", LL, 100/box | \$7.99/box |
| 26108 | 3cc, 20g x 1", LL, 100/box | \$7.99/box |
| 26110 | 3cc, 18g x 1.5", LL, 100/box | \$7.99/box |
| 26115 | 3cc, 22g x 3/4", LL, 100/box | \$7.99/box |
| 26601 | 3cc, 22g x 3/4", LS, 100/box | \$7.99/box |

Exel Syringes

| | | |
|-------|---|-------------|
| 26048 | 1cc tuberculin, luer slip, 100/box | \$11.25/box |
| 26200 | 3cc, LL, 100/box | \$7.99/box |
| 26201 | 3cc, LS, 100/box | \$7.99/box |
| 26230 | 5-6cc, LL, 100/box | \$14.99/box |
| 26231 | 5-6cc, LS, 100/box | \$14.99/box |
| 26265 | 10-12cc, LL, 100/box | \$16.99/box |
| 26266 | 10-12cc, LS, 100/box | \$16.99/box |
| 26267 | 10-12cc, curved tip, non-sterile, feeding, 50/box | \$13.99/box |

Exel T.B. Syringe with Needle

| | | |
|-------|-------------------------------------|-------------|
| 26044 | 1cc tuberculin, 25g x 5/8", 100/box | \$14.99/box |
|-------|-------------------------------------|-------------|

Exel Needles

| | | |
|-------|---------------------|------------|
| 26410 | 22g x 3/4", 100/box | \$4.50/box |
|-------|---------------------|------------|

Syringes & Needles

B-D Syringes and Needles



B-D Luer-Lock Tip Syringe

Syringe B-D Luer Lock, 100/BX

| | | |
|--------|-------------------|------------|
| 309585 | 3cc, L/L, 100/bx | \$11.99/bx |
| 309646 | 5cc, L/L, 125/bx | \$19.99/bx |
| 309604 | 10cc, L/L, 100/bx | \$18.99/bx |
| 309661 | 20cc, L/L, 40/bx | \$16.99/bx |
| 309650 | 30cc, L/L, 40/bx | \$19.99/bx |
| 309653 | 60mL, L/L, 40/bx | \$23.99/bx |

B-D Syringe Luer Slip

| | | |
|--------|-----------------------|------------|
| 301625 | 20cc Luer Slip, 40/bx | \$16.99/bx |
| 301603 | 5cc Luer Slip, 40/bx | \$14.99/bx |

Syringe & Needle Combo

| | | |
|--------|----------------------------|------------|
| 309626 | 1cc 25g x 5/8, T.B. 100/bx | \$19.99/bx |
| 309580 | 3cc 18g x 1 1/2", 100/bx | \$14.99/bx |
| 309579 | 3cc 20 x 1 1/2, 100/bx | \$14.99/bx |
| 309578 | 3cc 20g x 1", 100/bx | \$14.99/bx |
| 309575 | 3cc 21g x 1", 100/bx | \$14.99/bx |
| 309574 | 3cc 22g x 1 1/2", 100/bx | \$14.99/bx |
| 309572 | 3cc 22g x 1", 100/bx | \$14.99/bx |
| 309571 | 3cc 23g x 1", 100/bx | \$14.99/bx |
| 309582 | 3cc 25g x 1 1/2", 100/bx | \$14.99/bx |
| 309581 | 3cc 25g x 1", 100/bx | \$14.99/bx |
| 309570 | 3cc 25g x 5/8, 100/bx | \$14.99/bx |

B-D Needles

| | | |
|--------|----------------------|------------|
| 305198 | 16g x 1 1/2", 100/bx | \$14.95/bx |
| 305197 | 16g x 1", 100/bx | \$14.95/bx |
| 305196 | 18g x 1 1/2", 100/bx | \$7.95/bx |
| 305195 | 18g x 1", 100/bx | \$7.95/bx |
| 305175 | 20g x 1", 100/bx | \$7.95/bx |
| 305165 | 21g x 1", 100/bx | \$7.95/bx |
| 305156 | 22g x 1 1/2", 100/bx | \$7.95/bx |
| 305155 | 22g x 1", 100/bx | \$7.95/bx |
| 305145 | 23g x 1", 100/bx | \$7.95/bx |
| 305127 | 25g x 1 1/2", 100/bx | \$7.95/bx |
| 305125 | 25g x 1", 100/bx | \$7.95/bx |
| 305122 | 25g x 5/8", 100/bx | \$7.95/bx |
| 305136 | 27g x 1 1/4", 100/bx | \$7.95/bx |
| 305128 | 30g x 1", 100/bx | \$19.95/bx |
| 305106 | 30g x 1/2", 100/bx | \$19.95/bx |

Easy Touch™ Insulin Syringe



EasyTouch™ Insulin Syringes are designed and manufactured to deliver the highest level of comfort to the consumer. Our special needles are triple-bevel cut to a super sharp point, electro-polished to remove microscopic burrs, and film coated for a smoother injection.

Picture used as a graphic representation actual product may vary

| | | |
|--------|---|------------|
| 830165 | 1cc 30g x 5/16" U-100 insulin 100/bx | \$14.95/bx |
| 830365 | 3/10cc 30g x 5/16" U-100 insulin 100/bx | \$14.95/bx |
| 830565 | 1/2cc 30g x 5/16" U-100 insulin 100/bx | \$14.95/bx |



MVP Vet Insulin Syringe

The MVP Vet U-40 Insulin Syringe is film coated for maximum comfort and lines up precisely for accurate readings. There is no dead space for accurate dosage and less waste. MVP Vet Syringes are 100% latex free and offer the same quality as EasyTouch Insulin syringes, for your pet.

Picture used as a graphic representation actual product may vary

| | | |
|--------|--|------------|
| 839150 | 1cc 29g x 1/2" U-40 vet insulin 100/bx | \$14.99/bx |
| 839550 | 1/2cc 29g x 1/2" U-40 vet insulin 100/bx | \$14.99/bx |

Jorvet Dose Syringe

Dose Syringe - 400cc capacity: over 13 ounces. Manufactured with an almost unbreakable, clear nylon barrel excellent for use with stomach tubes or for rinsing out the mouth before a dental procedure. Includes silicone lubricant. Nozzle: 4" L. 1/4" i.d. dia

| | | |
|-------------|-------------------------------|------------|
| JOR111JW | Dose syringe 400ml | \$54.00/ea |
| JOR111JWL | Dose syringe, 600 ml | \$81.00/ea |
| JOR111JWO | O-Ring for 400cc | \$5.10/ea |
| JOR111JWLD1 | O-Ring for 600cc dose syringe | \$4.50/ea |
| JOR111JWD1 | Nozzle pipe only | \$24.00/ea |

JorVet

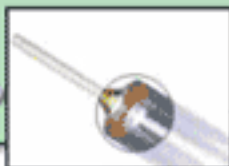

13822 WEST BOULTON BLVD. METTAWA, IL 60045

Phone 800-544-7521

60

WWW.SHOPMEDVET.COM

Fax 800-204-2177

NIPRO



Nipro Syringes

| | | |
|--------|------------------------------|------------|
| JD01T | 1cc Syringe L/S, T.B. 100/Bx | \$9.95/bx |
| JD03L | 3cc L/L 100/bx | \$6.95/bx |
| JD03S | 3cc L/S 100/bx | \$6.95/bx |
| JD05L | 5cc L/L 100/bx | \$11.95/bx |
| JD05S | 5cc L/S 100/bx | \$11.95/bx |
| JD10L | 10cc L/L 100/bx | \$14.95/bx |
| JD10S | 10cc L/S 100/bx | \$14.95/bx |
| JD20ES | 20cc E/L/S 50/bx | \$19.99/bx |
| JD20L | 20cc L/L 50/bx | \$19.99/bx |
| JD30ES | 30cc E/L/S 50/bx | \$22.95/bx |
| JD30L | 30cc L/L 50/bx | \$22.95/bx |
| JD50ES | 50cc E/L/S 25/bx | \$14.50/bx |
| JD50L | 50cc L/L 25/bx | \$14.95/bx |



Nipro Syringe and Needle Combo

| | | |
|-----------|----------------------------|------------|
| JD01T2516 | 1cc, 25 x 5/8" T.B. 100/bx | \$11.95/bx |
| JD01T2609 | 1cc 26 x 3/8 T.B. 100/bx | \$11.95/bx |
| JD01T2713 | 1cc 27x1/2 T.B. 100/bx | \$11.95/bx |
| JD03L2025 | 3cc 20 x 1 L/L 100/bx | \$7.95/bx |
| JD03L2038 | 3cc 20 x 1 1/2 L/L 100/bx | \$7.95/bx |
| JD03S2025 | 3cc 20 x 1 L/S 100/bx | \$7.95/bx |
| JD03L2125 | 3cc 21 x 1 L/L 100/bx | \$7.95/bx |
| JD03L2238 | 3cc 22 x 1 1/2 L/L 100/bx | \$7.95/bx |
| JD03L2225 | 3cc 22 x 1 L/L 100/bx | \$7.95/bx |
| JD03S2225 | 3cc 22 x 1 L/S 100/bx | \$7.95/bx |
| JD03L2219 | 3cc 22 x 3/4 L/L 100/bx | \$7.95/bx |
| JD03S2219 | 3cc 22 x 3/4 L/S 100/bx | \$7.95/bx |
| JD03S2516 | 3cc 22 x 5/8 L/S 100/bx | \$7.95/bx |
| JD03L2325 | 3cc 23 x 1 L/L 100/bx | \$7.95/bx |
| JD03L2538 | 3cc 25 x 1 1/2 L/L 100/bx | \$7.95/bx |
| JD03L2525 | 3cc 25 x 1 L/L 100/bx | \$7.95/bx |
| JD03L2516 | 3cc 25 x 5/8 L/L 100/bx | \$7.95/bx |
| JD05L2038 | 5cc 20 x 1 1/2 L/L 100/bx | \$17.95/bx |
| JD05L2025 | 5cc 20 x 1 L/L 100/bx | \$17.95/bx |
| JD05L2138 | 5cc 21 x 1 1/2 L/L 100/bx | \$17.95/bx |
| JD05L2225 | 5cc 22 x 1 L/L 100/bx | \$17.95/bx |
| JD05L2238 | 5cc 22 x 1 1/2 L/L 100/bx | \$17.95/bx |
| JD10L2038 | 10cc 20 x 1 1/2 L/L 100/bx | \$17.95/bx |
| JD10L2025 | 10cc 20 x 1 L/L 100/bx | \$17.95/bx |
| JD10L2238 | 10cc 22 x 1 1/2 L/L 100/bx | \$17.95/bx |
| JD10L2225 | 10cc 22 x 1 L/L 100/bx | \$17.95/bx |

Nipro Luer Adapter (Multi-Sample)

NIPRO Luer Adapter Designed for optimum efficiency: Luer Adapter allows for multiple draws with a single venipuncture. Accommodates needles sizes ranging from 23G to 19G to meet a wide spectrum of patient needs Dual capability permits use for either blood collection or a venous injection. Proprietary back end needle design facilitates smooth penetration of rubber tube stopper.

| | | |
|-------|-----------------------------------|------------|
| LM20G | Luer Adapter Multi-Sample, 100/Bx | \$14.50/bx |
|-------|-----------------------------------|------------|

Blood Collection Needle

- Multiple-Draw needle design provides the convenience of several sample collections with a single venipuncture.
- Needle is ultra-sharp and with smooth edges for atraumatic insertion and easy penetration.
- Color-coded hubs assure accurate and convenient gauge size identification.

| | | |
|---------|---------------------|-----------|
| NM20G38 | 20g x 1 1/2" 100/bx | \$8.95/bx |
| NM20G25 | 20g x 1" 100/bx | \$8.95/bx |
| NM21G38 | 21g x 1 1/2" 100/bx | \$8.95/bx |
| NM21G25 | 21g x 1" 100/bx | \$8.95/bx |
| NM22G38 | 22g x 1 1/2" 100/bx | \$8.95/bx |
| NM22G25 | 22g x 1" 100/bx | \$8.95/bx |

Nipro Needles

| | | |
|--------|---------------------|-----------|
| AH1838 | 18g x 1 1/2" 100/bx | \$4.95/bx |
| AH1825 | 18g x 1" 100/bx | \$4.95/bx |
| AH2038 | 20g x 1 1/2" 100/bx | \$4.95/bx |
| AH2025 | 20g x 1" 100/bx | \$4.95/bx |
| AH2125 | 21g x 1" 100/bx | \$4.95/bx |
| AH2238 | 22g x 1 1/2" 100/bx | \$4.95/bx |
| AH2225 | 22g x 1" 100/bx | \$4.95/bx |
| AH2219 | 22g x 3/4" 100/bx | \$4.95/bx |
| AH2325 | 23g x 1" 100/bx | \$4.95/bx |
| AH2525 | 25g x 1" 100/bx | \$4.95/bx |
| AH2538 | 25g x 1 1/2" 100/bx | \$4.95/bx |
| AH2516 | 25g x 5/8" 100/bx | \$4.95/bx |
| AH2732 | 27g x 1 1/4" 100/bx | \$4.95/bx |
| AH3013 | 30g x 1/2" 100/bx | \$6.95/bx |



Syringes & Needles

Nylon & Bulb Syringes, Caps & Drenchers

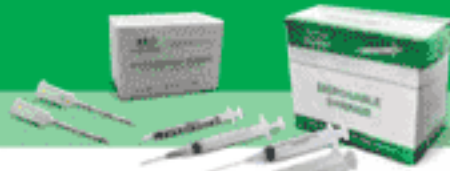

Nylon Syringe Jorgensen

The nylon syringe, with an expanded range of sizes, is now available. Virtually unbreakable nylon with transparent barrel, economically priced with easy-to-read black etched dose markings. Combination of luer lock and luer slip adaptor.



| | | |
|----------|-------|------------|
| JOR111AN | 10cc | \$6.20/ea |
| JOR111BN | 20cc | \$6.55/ea |
| JOR111CN | 30cc | \$6.85/ea |
| JOR111DN | 50cc | \$8.00/ea |
| JOR111FN | 100cc | \$12.00/ea |

With Dosage Wheel

| | | |
|-----------|------------------------------|-----------|
| JOR111AWN | Includes dosage wheel. 10cc. | \$8.65/ea |
| JOR111BWN | Includes dosage wheel. 20cc. | \$8.00/ea |
| JOR111CWN | Includes dosage wheel. 30cc. | \$8.70/ea |
| JOR111DWN | Includes dosage wheel. 50cc. | \$9.90/ea |

O Ring Only

| | | |
|-----------|------------------|-----------|
| JOR111ANO | 10cc, "O" ring. | \$0.90/ea |
| JOR111BNO | 20cc, "O" ring. | \$0.90/ea |
| JOR111CNO | 30cc, "O" ring. | \$1.05/ea |
| JOR111DNO | 50cc, "O" ring. | \$1.50/ea |
| JOR111FNO | 100cc, "O" ring. | \$1.35/ea |

Sheep/Goat Oral Drencher Kit

A handy kit that has everything needed for drenching small ruminants. Includes an extra "O" ring to fit a 20cc nylon syringe, and an oral dose adaptor.

JOR111Q \$13.50/ea



Silicone Lubricant

JOR111SG 1 gallon \$107.00/ea
 JOR111S 30ml. \$3.30/ea

Silkospray

JOR111SP \$82.00/ea



Ear-Ulcer Syringe

Soft pliable material makes these syringes safe and easy to use. Whether irrigating or suctioning, the smooth tapered tip facilitates fluid administration/retrieval and reduces trauma. Ribbed bulb provides a non-slip grip.

| | | |
|-------------|-----|-----------|
| EAR-SYR-10Z | 1oz | \$0.95/ea |
| EAR-SYR-20Z | 2oz | \$1.49/ea |
| EAR-SYR-30Z | 3oz | \$1.49/ea |



Ear Syringe

The ear/ulcer syringe is ideal for irrigating smaller wounds and cleansing nasal passages of newborns.

| | | |
|-----------|------------|------------|
| DYND70280 | 2oz, 50/cs | \$52.11/cs |
| DYND70277 | 3oz, 50/cs | \$52.11/cs |

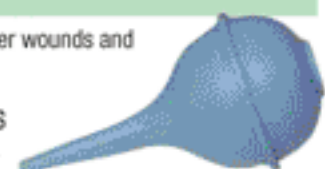

Jorvet Bulb Syringe



Excellent for aspiration of surgical sites. Also can be used to flush surgical sites. The rubber bulb is attached to a 60ml syringe, thus, 60ml capacity. Sterile.

JOR487B \$2.10/ea



Feeding Syringe

Feeding and Irrigation Syringe: This kit includes a flat-top 60 cc piston syringe with luer tip adapter, I.V. pole bag with re-sealable flap and write-on patient I.D. Label. Irrigation/feeding syringe, IV pole bag, luer tip adapter, flat ring plunger, rounded with flat top, 60cc. 30 a case

DYND70642 Feeding Syringe Flat Tip w/Ring \$13.79/cs



Piston Syringe

Contro-Piston Irrigation Syringe: Contro-Piston Syringe Offers Uninterrupted Action in a Single-Hand Technique The sterile, disposable syringe with thumb ring is designed to minimize hand slippage and prevent contamination. The barrel features raised, large and easy-to-read graduations, which are calibrated in oz and cc. The tip, elongated to facilitate tube feeding, has an extra-large orifice for better removal of clots and mucous shreds. Includes: Soft Tray and Paper Lidding. 50 a case

DYND20325 60mL syringe \$39.95/cs



Jorvet Syringe Cap



Protective cap will seal off syringe to prevent leakage or contamination. Unique cap has one end for female luer attachment to syringe. The other end can be used to seal off a needle or catheter hub. Sterile.

JOR464 Dual Blue 100/Pack \$16.50/pk

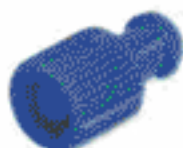

Needle Counter

Red plastic box allows you to count the needles and blades plus gives you ability to secure them, insuring the safety of the surgical personnel during procedures. Foam Block/Adhesive, 20 ct.

DYNNJC20A 20 ct, 64/cs \$103.00/cs



13822 WEST BOULTON BLVD. METTAWA, IL 60045

Phone 800-544-7521

62

WWW.SHOPMEDVET.COM

Fax 800-204-2177

Syringes & Needles

Henke Roux Revolver & Ferromatic Automatic Syringes

Henke Roux Revolver

A high quality precision-made revolver syringe. Of German origin it's known for its accuracy. Dosage is set by turning the dosage setting wheel at the rear of the barrel. For long lasting dependability, durability and accuracy, buy the "HENKE" Roux.

JOR53HB Henke Roux. 10cc, adjusts to 1/4, 1/2 & 1cc. \$54.00

Henke Roux Revolver Parts

| | | |
|-----------|---|---------|
| JOR53D12 | Cap for #11 spring | \$0.60 |
| JOR53D18 | Compressing spring | \$0.45 |
| JOR53D44 | Compression spring | \$2.10 |
| JOR53D31B | Disc for piston, 10cc | \$3.00 |
| JOR53D31 | Disc for piston, 30cc & 50cc | \$1.50 |
| JOR53D20B | Dosage wheel, 10cc | \$6.00 |
| JOR53D20 | Dosage wheel, 30cc & 50cc | \$6.90 |
| JOR53D36 | Dosage wheel, 30cc minidose | \$9.00 |
| JOR53D24B | Front end with luerlock, 10cc | \$5.70 |
| JOR53D24 | Front end with luerlock, 30cc & 50cc | \$10.50 |
| JOR53D26B | Glass barrel, 10cc | \$3.90 |
| JOR53D26A | Glass barrel, 30cc | \$3.30 |
| JOR53D13 | Gudgeon bolt | \$1.35 |
| JOR53D7 | Handle connecting screw | \$6.00 |
| JOR53D55 | Henke dosage repair kit (incl. 2, 11, 42, 43) | \$7.50 |
| JOR53D49 | Henke dosage wheel | \$19.50 |
| JOR53D2 | Henke dosage wheel screw | \$1.50 |
| JOR53D53 | Henke forward handle, complete | \$24.00 |
| JOR53D56 | Henke plunger rod kit (incl. 28, 30, 31, 32, 33) Henke plunger rod kit (incl. 28, 30, 31, 32, 33) | \$27.00 |
| JOR53D51 | Henke ratchet clip | \$1.50 |
| JOR53D52 | Henke ratchet screw | \$1.80 |
| JOR53D45 | Henke rear handle, complete | \$45.00 |

| | | |
|-----------|------------------------------------|---------|
| JOR53D54 | Henke Roux repair kit | \$21.00 |
| JOR53D26 | Glass barrel, 50cc | \$3.90 |
| JOR53D42 | Henke set screw | \$3.35 |
| JOR53D43 | Henke steel ball, 4 mm | \$1.80 |
| JOR53D28B | Inner rod, 10cc | \$6.00 |
| JOR53D28A | Inner rod, 30cc | \$6.90 |
| JOR53D28 | Inner rod, 50cc | \$6.90 |
| JOR53D33 | Knurled knob | \$6.00 |
| JOR53D27B | Metal frame, 10cc | \$14.40 |
| JOR53D27A | Metal frame, 30cc | \$14.40 |
| JOR53D27 | Plastic barrel with luerlock, 50cc | \$14.40 |
| JOR53D32B | Outer rod, 10cc | \$9.60 |
| JOR53D32A | Outer rod, 30cc | \$9.60 |
| JOR53D37 | Outer rod, 30cc minidose | \$4.50 |
| JOR53D32 | Outer rod, 50cc | \$9.60 |
| JOR53D26D | Plastic barrel, 30cc | \$2.40 |
| JOR53D26P | Plastic barrel, 50cc | \$3.90 |
| JOR53D26R | Plastic barrel with luerlock, 50cc | \$10.50 |
| JOR53D14 | Ratchet tip | \$5.40 |
| JOR53D18 | Rear grip, 10cc | \$33.00 |
| JOR53D1 | Rear grip, 30cc & 50cc | \$36.00 |
| JOR53D30B | Rubber piston, 10cc | \$1.80 |
| JOR53D30 | Rubber piston, 30cc & 50cc | \$1.80 |
| JOR53D35 | Spring for handles | \$3.90 |
| JOR53D25B | Washer set, 10cc | \$3.30 |
| JOR53D25 | Washer set, 30cc & 50cc | \$3.30 |

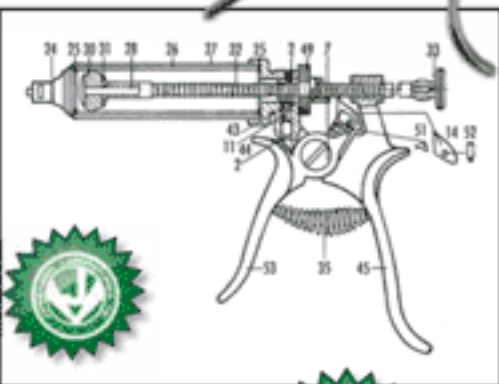

Ferromatic Automatic Syringe

Unique design has dosage adjustments from .5ml to 5.0ml. Fits bottle tops from 30ml-120ml.

Features:

- One-piece front end with luer lock
- A valve accessory allowing user to adapt the syringe for use with a collapsible bottle (part #14c optional)
- Tubing and attachment to allow draw offs from bottles (optional)
- New plastic valve system to prevent valve "swelling"

JOR53F91 5cc, M91 \$113.00

Ferromatic Automatic Syringe Parts

| | | |
|-------------|----------------------------|---------|
| JOR53FD191 | Barrel Frame, M91 | \$27.00 |
| JOR53FD21 | Closing cap | \$2.70 |
| JOR53FD11 | Compression spring | \$3.90 |
| JOR53FD1191 | Compression spring, M91 | \$3.00 |
| JOR53FD6 | Crutch handle | \$3.00 |
| JOR53FD8 | Dosing device | \$4.50 |
| JOR53FD891 | Dosing device M91 | \$6.00 |
| JOR53FD8M | Dosing device, M86 | \$4.50 |
| JOR53FD10M | End washer, M86 & M91 | \$1.80 |
| JOR53FD9 | Fixing nut | \$2.25 |
| JOR53FD991 | Fixing nut, M91 | \$2.25 |
| JOR53FD1M | Frame, M86 | \$24.00 |
| JOR53FD2291 | Front piece, M91 | \$33.00 |
| JOR53FD691 | Front screw | \$10.50 |
| JOR53FD2M | 5cc, M86, M91 | \$6.00 |
| JOR53FD7 | Guiding cap | \$1.80 |
| JOR53FD791 | Guiding cap M91 | \$6.00 |
| JOR53FD7M | Guiding cap, M86 | \$1.80 |
| JOR53FD23 | Luerlock adaptor | \$4.50 |
| JOR53FD4 | O-Ring Washer piston | \$1.80 |
| JOR53FD3 | Piston | \$3.30 |
| JOR53FD5M | Piston rod and handle, M86 | \$9.00 |
| JOR53FD16 | Outlet valve spring* | \$0.00 |

| | | |
|--------------|--|---------|
| JOR53FD591 | Piston rod and handle, M91 | \$10.50 |
| JOR53FD27 | Piston rod assembly, 3, 4, 5, 6 | \$12.00 |
| JOR53FD391 | Piston, M91 | \$4.50 |
| JOR53FD2891 | Repair kit 14, 10M, 2 of 1291, 1391, 1691 | \$30.00 |
| JOR53FD28 | Repair kit (4, 10, 3 of 12, 13, 16, 17, 18, 20, 25) | \$21.60 |
| JOR53FD26M | Repair kit (4, 10M, 3 of 12, 13, 16, 17, 18, 20, 25) | \$21.60 |
| JOR53FD12 | Rubber valve* | \$3.00 |
| JOR53FD19M | Screw cap - 07 | \$9.00 |
| JOR53FD19 | Screw cap | \$4.50 |
| JOR53FD3191 | Tubing | \$6.00 |
| JOR53FD3291 | Attachment | \$6.00 |
| JOR53FD14C | Valve head, M91, collapsible bottle | \$36.00 |
| JOR53FD14G | Valve head, M91, non-collapsible bottle | \$30.00 |
| JOR53FD15 | Valve head screw* | \$3.00 |
| JOR53FD14V91 | Valve screw | \$6.00 |
| JOR53FD1391 | Valve spring | \$2.10 |
| JOR53FD2591 | Washer | \$0.00 |
| JOR53FD16 | Washer for 14c | \$0.00 |
| JOR53FD20 | Washer for 14g* | \$0.00 |
| JOR53FD4M | Washer piston | \$1.80 |

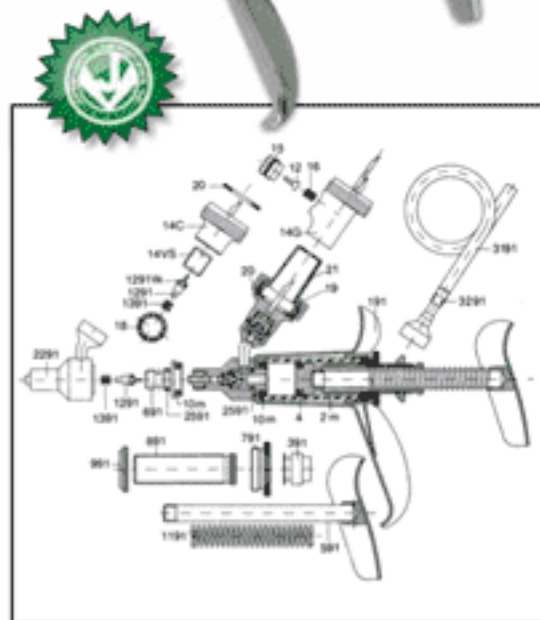

13822 WEST BOULTON BLVD. METTAWA, IL 60045

Phone 800-544-7521

63

WWW.SHOPMEDVET.COM

Fax 800-204-2177

Syringes & Needles

Hauptner & Vetamatic Syringes

Hauptner Syringe

Famously accurate and correct dosing.

| | | | |
|--------|--|------------|----------|
| JOR31A | 10cc, adjusts to 1/4, 1/2, 3/4, and 1cc doses. | NEW | \$108.00 |
| JOR31B | 30cc, adjusts to 1, 2, 3, 4, and 5cc doses. | | \$83.00 |
| JOR31C | 50cc, adjusts to 1, 2, 3, 4, and 5cc doses. | | \$88.35 |
| JOR31E | 25cc, adjusts to 1/2, 1, 1 1/2, 2 and 2 1/2. Excellent for injecting Ivomec® | | \$112.50 |



Hauptner Syringe Parts

| | | |
|------------|---|---------|
| JOR31BMD | 2cc Glass barrel | \$30.00 |
| JOR31D1 | Complete grip, 30cc & 50cc Complete grip, 30cc & 50cc | \$65.00 |
| JOR31D22 | Luerlock with endplate, 30cc & 50cc | \$6.60 |
| JOR31D15A | Glass barrel, 10cc | \$3.90 |
| JOR31D15E | Glass barrel, 25cc | \$3.90 |
| JOR31D15B | Glass barrel, 30cc | \$3.90 |
| JOR31D15C | Glass barrel, 50cc | \$3.90 |
| JOR31D23 | HAUPTNER repair kit (incl. 6, 7, 15c, 16m) | \$13.80 |
| JOR31D10A | Inner rod, 10cc | \$8.40 |
| JOR31D10E | Inner rod, 25cc | \$7.50 |
| JOR31D10B | Inner rod, 30cc | \$8.70 |
| JOR31D10C | Inner rod, 50cc | \$7.50 |
| JOR31D22A | Luerlock with endplate, 10cc | \$9.00 |
| JOR31D22DE | Luerlock with endplate, 25cc | \$13.50 |
| JOR31D14A | Metal cover, 10cc | \$15.00 |
| JOR31D14E | Metal cover, 25cc | \$21.00 |
| JOR31D14B | Metal cover, 30cc | \$15.00 |

| | | |
|-------------|---------------------------------|----------|
| JOR31D14C | Metal cover, 50cc | \$15.60 |
| JOR31D11A | Outer rod, 10cc | \$9.00 |
| JOR31D11E | Outer rod, 25cc | \$9.00 |
| JOR31D11B | Outer rod, 30cc | \$9.30 |
| JOR31D11C | Outer rod, 50cc | \$8.40 |
| JOR31TBM | Perpendo TB syringe, 2cc | \$120.00 |
| JOR31D16PRE | Piston rubber (only 25cc) | \$1.50 |
| JOR31D15PB | Plastic barrel, 30cc | \$2.40 |
| JOR31D15PC | Plastic barrel, 50cc | \$3.90 |
| JOR31D12A | Plate for plunger, 10cc | \$4.50 |
| JOR31D12E | Plate for plunger, 25cc | \$4.50 |
| JOR31D12 | Plate for plunger, 30cc & 50cc | \$2.70 |
| JOR31H | Revolver Holder | \$0.00 |
| JOR31D1A | Complete grip, 10cc | \$60.00 |
| JOR31D1E | Complete grip, 25cc | \$60.00 |
| JOR31D29A | Thumb grip with regulator, 10cc | \$39.00 |
| JOR31D29E | Thumb grip with regulator, 25cc | \$42.00 |
| JOR31D3 | Grip with ratchet | \$27.00 |

| | | |
|-----------|--|---------|
| JOR31D4 | Lock screw | \$1.95 |
| JOR31D8A | Dosage regulator, 10cc | \$24.00 |
| JOR31D9A | Complete plunger, 10cc | \$22.80 |
| JOR31D9B | Complete plunger, 30cc | \$24.00 |
| JOR31D9C | Complete plunger, 50cc | \$22.50 |
| JOR31D9E | Complete plunger, 25cc | \$24.00 |
| JOR31D5 | Spring for grips | \$1.20 |
| JOR31T8C | TB caliper | \$90.00 |
| JOR31T8N | TB needle | \$12.60 |
| JOR31D13A | Tension screw, 10cc | \$3.90 |
| JOR31D13 | Tension screw, 25cc, 30cc, 50cc | \$3.90 |
| JOR31D2A | Thumb grip less regulator, 10cc | \$28.00 |
| JOR31D2 | Thumb grip less regulator, 30cc & 50cc | \$19.50 |
| JOR31D16A | Washer pack set, 10cc | \$4.50 |
| JOR31D16E | Washer pack set, 25cc | \$4.50 |
| JOR31D16 | Washer pack set, 30cc & 50cc | \$4.20 |
| JOR31D16M | Washer pack set, modified, 30cc & 50cc | \$4.50 |

Vetamatic Syringe, 5cc

A handy, sturdy automatic multidose syringe. Plastic valve and washer reduces swelling problems.

NOTE: Spare Parts Ordering: Parts 13, 1494 and 1694 as shown on parts diagram are not available individually. They can be purchased only as a repair kit: J-53vd 2894

JOR53V94 .5ml to 5.0ml. \$84.00/ea



Vetamatic Syringe Parts

| | | |
|-------------|----------------------------|---------|
| JOR53VD794 | Compression spring | \$2.40 |
| JOR53VD9M | Dose fixing nut, M86 | \$4.50 |
| JOR53VD8M | Dosing screw and tube, M86 | \$7.50 |
| JOR53VD894 | Dosing sheath | \$6.00 |
| JOR53VD24A | Filter needle, 4 3/4" | \$9.00 |
| JOR53VD24B | Filter needle, 7 1/2" | \$18.00 |
| JOR53VD24C | Filter needle, 8 1/2" | \$13.50 |
| JOR53VD994 | Fixing nut | \$2.40 |
| JOR53VD1794 | Front end | \$18.00 |
| JOR53VD17M | Front end, M86 | \$18.00 |
| JOR53VD294 | Front screw | \$5.10 |
| JOR53VD4M | Glass barrel, M86 & M91 | \$6.00 |
| JOR53VD1M | Metal frame | \$27.00 |
| JOR53VD1294 | Piston | \$4.50 |
| JOR53VD594 | Piston rod | \$28.00 |

| | | |
|-------------|--|---------|
| JOR53VD2894 | Repair kit (2 each of 13, 1494, 1694) | \$21.00 |
| JOR53VD28 | Repair kit (3, 11, 13, 2 of 14, 15, 16, 18) | \$18.00 |
| JOR53VD28M | Repair kit M86 (3m, 13, 2 of 14, 15, 16, 18) | \$19.50 |
| JOR53VD1094 | Screw cap | \$6.00 |
| JOR53VD10M | Screw cap, M86 | \$3.90 |
| JOR53VD26 | Screw cap, M91 | \$9.00 |
| JOR53VD22 | Sinker | \$2.25 |
| JOR53VD6 | Spring sleeve | \$2.10 |
| JOR53VD7M | Spring, M86 | \$3.90 |
| JOR53VD23 | Tubing | \$6.00 |
| JOR53VD1494 | Valve and washer | \$6.00 |

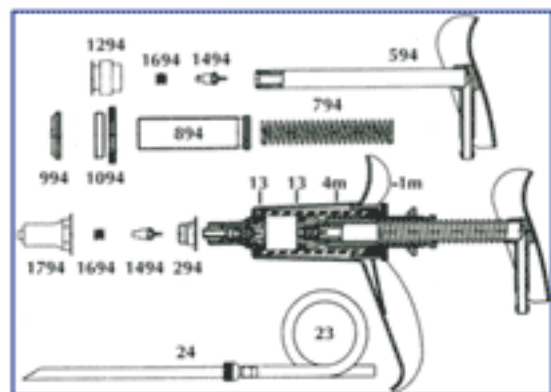

Syringes & Needles

Vetamatic & Henke Drench-Matic Syringes



Henke Drench-Matic 23cc **Jorvet**

An automatic syringe for administration of solutions and suspensions. Its transparent plastic graduated barrel allows instant check of dosage setting. An "anti-block" valve system prevents blocking, so that smooth continuous operation is guaranteed. Easily adjusts from 0-23ml in 2.5ml increments. Special hardened enamel painting provides both aesthetics and durability.

JOR128M Drench-Matic Syringe complete with container. \$160.00

Henke Drench-Matic Parts

| | | | | | |
|------------|----------------------|------------|-------------|---------------------------------------|------------|
| JOR128MD1 | Barrel frame | \$36.00/ea | JOR128MD8W | Nozzle washer only | \$1.80/ea |
| JOR128MD32 | Cap & nozzle | \$3.90/ea | JOR128MD14 | Nylon piston | \$15.00/ea |
| JOR128MD31 | Container complete | \$36.00/ea | JOR128MD11 | Piston rod | \$15.00/ea |
| JOR128MD24 | Disc | \$1.80/ea | JOR128MD10 | Piston rod complete (6,7,11,12,13,14) | \$33.00/ea |
| JOR128MD20 | Dosing screw | \$4.50/ea | JOR128MD13 | Piston washer | \$4.50/ea |
| JOR128MD21 | Dosing screw nut | \$7.50/ea | JOR128MD2P | Plastic barrel, 23cc | \$9.75/ea |
| JOR128MD28 | Feeding tube | \$10.50/ea | JOR128MD18 | Plastic insert (2) | \$1.80/pr |
| JOR128MD26 | Frame screw | \$0.90/ea | JOR128MD17 | Rear handle | \$21.00/ea |
| JOR128MD3 | Front end piece | \$9.00/ea | JOR128MD36 | Repair kit (4,6,6w,8w,13,14,30w) | \$30.00/ea |
| JOR128MD15 | Front handle | \$33.00/ea | JOR128MD4 | Round washer | \$3.00/ea |
| JOR128MD19 | Handle screw | \$2.25/ea | JOR128MD16 | Spring pin | \$0.45/ea |
| JOR128MD22 | Handle spring | \$6.00/ea | JOR128MD33 | Straps | \$7.50/ea |
| JOR128MD30 | Injection attachment | \$15.00/ea | JOR128MD6 | Valve and washer | \$6.90/ea |
| JOR128MD25 | Knurled knob | \$7.50/ea | JOR128MD12 | Valve screw | \$4.50/ea |
| JOR128MD5 | Lock nut for #3 | \$3.00/ea | JOR128MD7 | Valve spring | \$4.50/ea |
| JOR128MD23 | Lower spring screw | \$4.50/ea | JOR128MD30W | Washer for #30 | \$2.10/ea |
| JOR128MD8 | Nozzle and washer | \$16.50/ea | | | |
| JOR128MD9 | Nozzle nut | \$7.50/ea | | | |

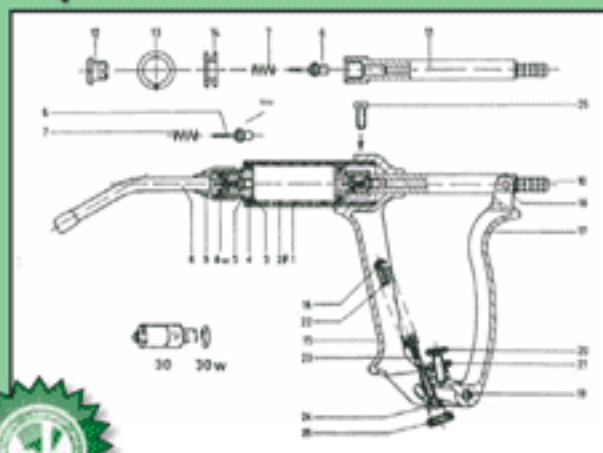

Vaxi-Drench 15 Injector/Drenche, 15cc

Designed for administration of all drenches or injectable solutions within its dose range. Comes complete with 2.9 liter vinyl reservoir, strapping, funnel and necessary tubing. Manufactured exclusively for Jorgensen Labs. Adjust from 2.5cc to 15cc in 1/2cc increments.

JOR126 Injector/Drencher \$274.00/ea **Jorvet**



Vetamatic Syringe Parts

| | | | | | |
|-----------|-----------------------------|---------|-----------|----------------------------------|---------|
| JOR126D19 | Adaptor | \$15.00 | JOR126D12 | Nozzle | \$15.00 |
| JOR126D31 | Cap & nozzle | \$16.50 | JOR126D16 | Nozzle nut | \$9.00 |
| JOR126D29 | Container complete | \$54.00 | JOR126D9 | Nozzle seal ring | \$2.70 |
| JOR126D18 | Cylinder | \$24.00 | JOR126D1 | Piston cap | \$7.80 |
| JOR126D15 | Cylinder cage | \$18.00 | JOR126D5 | Piston spacer | \$7.50 |
| JOR126D17 | Cylinder seal ring | \$3.90 | JOR126D4 | Piston washer, (2) | \$6.75 |
| JOR126D13 | Lock nut | \$7.50 | JOR126D6 | Push rod | \$38.00 |
| JOR126D23 | Dosage adjustor screw & nut | \$7.50 | JOR126D32 | Repair kit, parts 2,3,4,7,8,9,17 | \$22.50 |
| JOR126D30 | Feed tube & clamps | \$9.00 | JOR126D24 | Return spring | \$6.00 |
| JOR126D22 | Handle | \$30.00 | JOR126D25 | Return spring adjustor | \$12.00 |
| JOR126D28 | Handle clamp screw | \$2.70 | JOR126D26 | Return spring adjustor screw | \$9.00 |
| JOR126D10 | Injection attachment | \$24.00 | JOR126D3 | Valve & seal ring | \$8.40 |
| JOR126D20 | Lever | \$48.00 | JOR126D7 | Valve & seal ring | \$8.40 |
| JOR126D21 | Lever pad, set of 2 | \$7.00 | JOR126D2 | Valve spring | \$2.10 |
| JOR126D27 | Lever screw | \$12.00 | JOR126D8 | Valve spring | \$2.10 |
| JOR126D11 | Needle nut | \$9.00 | | | |

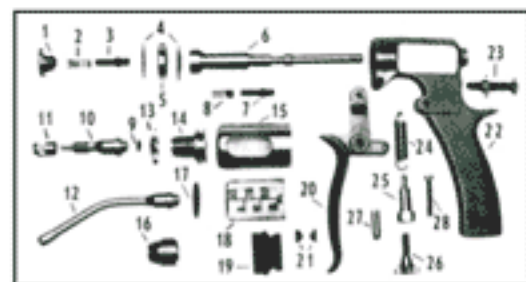

13822 WEST BOULTON BLVD. METTAWA, IL 60045

Phone 800-544-7521

65

WWW.SHOPMEDVET.COM

Fax 800-204-2177

Syringes & Needles

Needles- Feeding, Straight and Curved

Curved Feeding Needle

Luerlock hub with stainless steel tube and nickel-plated silver ball on the end.

| | | |
|-----------|----------|------------|
| JOR194CAH | 20g x 4" | \$45.00/ea |
| JOR194CBE | 18g x 2" | \$38.00/ea |
| JOR194CCE | 16g x 2" | \$46.00/ea |
| JOR194CCG | 16g x 3" | \$46.00/ea |
| JOR194CDE | 14g x 2" | \$55.00/ea |
| JOR194CDG | 14g x 3" | \$38.00/ea |



Straight Feeding Needle

Luerlock hub with stainless steel tube and nickel-plated silver ball on the end. Available in straight or curved. Specify type, gauge, and length when ordering.

| | | |
|-----------|----------|------------|
| JOR194SDH | 14g x 4" | \$46.00/ea |
|-----------|----------|------------|



Disposable Feeding Needle

Nylon luer hub accepts standard syringe. Sterile, 5/pkg

- Soft silicone rubber covered tips
- Malleable shaft to any angle
- Sterile
- Luer hub

| | | |
|----------|--------------------|------------|
| JOR194FA | 20g x 1 1/2", 5 pk | \$37.20/pk |
| JOR194FB | 18g x 2", 5 pk | \$22.50/pk |
| JOR194FC | 15g x 3", 5 pk | \$37.20/pk |

JorVet



Curved Needles, 2/pack

| | | |
|--------------|----------------------|------------|
| EJFNC10X4 | 10g x 4" 6.4mm Tip | \$29.67/pk |
| EJFNC12X25/8 | 12g x 2 5/8" Tip | \$25.68/pk |
| EJFNC12X4 | 12g x 4" 6.5mm Tip | \$22.08/pk |
| EJFNC12X4-ST | 12g x 4" Tip | \$25.68/pk |
| EJFNC14X2 | 14g x 2" 4mm Tip | \$19.47/pk |
| EJFNC14X3 | 14g x 3" 4mm Tip | \$19.47/pk |
| EJFNC14X4 | 14g x 4" 4mm Tip | \$16.68/pk |
| EJFNC16X2 | 16g x 2" 3mm Tip | \$16.68/pk |
| EJFNC16X3 | 16g x 3" 3mm Tip | \$16.68/pk |
| EJFNC16X4 | 16g x 4" 3mm Tip | \$16.68/pk |
| EJFNC18X2 | 18g x 2" 2.4mm Tip | \$15.06/pk |
| EJFNC18X3 | 18g x 3" 2.4mm Tip | \$15.06/pk |
| EJFNC18X4 | 18g x 4" 2.4mm Tip | \$15.06/pk |
| EJFNC20X1.5 | 20g x 1.5" 4mm Tip | \$15.06/pk |
| EJFNC22X1.5 | 22g x 1.5" 2.4mm Tip | \$15.06/pk |

Curved Needles, 3/pack

| | | |
|-----------|---------------------------|------------|
| EJFNC-A | 18g x 2", 14g x 3" - 3/Pk | \$30.68/pk |
| EJFNC10X6 | 10g x 6" 6.4mm Tip | \$29.67/pk |

Jorvert Aluminum Hub Needles **JorVet**

Thunderbolt Aluminum Hub Hypodermic Needles have aluminum hubs with stainless steel needle cannulas and are especially designed for the demands of injecting large animals. The needles are razor sharp and individually packaged in their own disposable two-piece cartridges. Sterile, 100/pkg

Features:

- Color coded by gauge
- Marked with needle gauge and length
- Competitively priced



| | | | | | |
|-----------|--------------------|------------|-----------|--------------------|------------|
| AN14GX1.5 | 14g x 1.5", 100/bx | \$14.00/bx | AN16GX3/4 | 16g x 3/4", 100/bx | \$14.20/bx |
| AN14GX2 | 14g x 2", 100/bx | \$14.00/bx | AN16GX5/8 | 16g x 5/8", 100/bx | \$14.20/bx |
| AN14GX3/4 | 14g x 3/4", 100/bx | \$14.00/bx | AN18GX.75 | 18g x 3/4", 100/bx | \$14.20/bx |
| AN16GX1 | 16g x 1", 100/bx | \$14.20/bx | AN18GX1 | 18g x 1", 100/bx | \$14.20/bx |
| AN16GX1.5 | 16g x 1.5", 100/bx | \$14.20/bx | AN18GX1.5 | 18g x 1.5", 100/bx | \$14.20/bx |
| AN16GX2 | 16g x 2", 100/bx | \$14.20/bx | AN18GX2 | 18g x 2", 100/bx | \$14.20/bx |
| | | | AN20GX.5 | 20g x 1/2", 100/bx | \$14.20/bx |

Straight Needles, 2/pack

| | | |
|--------------|--------------------|------------|
| EJFNS10X4 | 10g x 4" 6.4mm Tip | \$29.67/pk |
| EJFNS10X6 | 10g x 6" 6.4mm Tip | \$29.67/pk |
| EJFNS12X25/8 | 12g x 2 5/8" Tip | \$22.02/pk |
| EJFNS12X4 | 12g x 4" 6.5mm Tip | \$22.02/pk |
| EJFNS12X4-ST | 12g x 4" 4mm Tip | \$22.02/pk |
| EJFNS14X2 | 14g x 2" 4mm Tip | \$16.68/pk |
| EJFNS14X3 | 14g x 3" 4mm Tip | \$16.68/pk |
| EJFNS14X4 | 14g x 4" 4mm Tip | \$16.68/pk |
| EJFNS16X2 | 16g x 2" 3mm Tip | \$16.68/pk |
| EJFNS16X3 | 16g x 3" 3mm Tip | \$16.68/pk |

Straight Needles, 2/pack

| | | |
|-------------|--------------------|------------|
| EJFNS16X4 | 16g x 4" 3mm Tip | \$16.68/pk |
| EJFNS18X2 | 18g x 2" 2.4mm Tip | \$15.06/pk |
| EJFNS18X3 | 18g x 3" 2.4mm Tip | \$15.06/pk |
| EJFNS18X4 | 18g x 4" 2.4mm Tip | \$15.06/pk |
| EJFNS20X1.5 | 20g x 1.5" 2.4mm | \$15.06/pk |
| EJFNS22X1.5 | 22g x 1.5" 2.4mm | \$15.06/pk |

Straight Needles, 3/pack

| | | |
|---------|---|------------|
| EJFNS-A | 18g x 2", 14g x 3", and 10" x 6" - 3/pk | \$30.68/pk |
|---------|---|------------|

Syringes & Needles

JorVet Hypodermic Needles

Economy Hypodermic needles

Less expensive range of needles. Square hub with standard luer fit. Each needle imprinted with gauge size. 12/pkg.

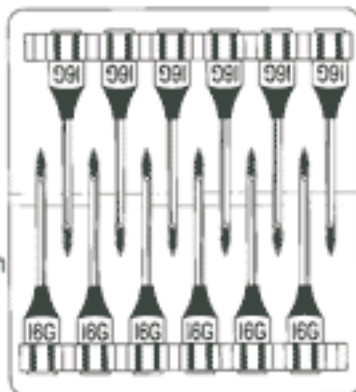

| | | |
|----------|------------------|-----------|
| JOR180BA | 18g x 1/2", dz | \$4.50/dz |
| JOR180BB | 18g x 3/4", dz | \$4.50/dz |
| JOR180BC | 18g x 1", dz | \$4.50/dz |
| JOR180BD | 18g x 1 1/2", dz | \$4.50/dz |
| JOR180BE | 18g x 2", dz | \$4.50/dz |
| JOR180CA | 16g x 1/2", dz | \$4.50/dz |
| JOR180CB | 16g x 3/4" dz | \$4.50/dz |
| JOR180CC | 16g x 1", dz | \$4.50/dz |
| JOR180CD | 16g x 1 1/2", dz | \$4.50/dz |
| JOR180CE | 16g x 2", dz | \$4.50/dz |
| JOR180CG | 16g x 3", dz | \$4.50/dz |
| JOR180CH | 16g x 4", dz | \$4.50/dz |
| JOR180DA | 14g x 1/2", dz | \$4.50/dz |
| JOR180DB | 14g x 3/4", dz | \$4.50/dz |
| JOR180DC | 14g x 1", dz | \$4.50/dz |
| JOR180DD | 14g x 1 1/2", dz | \$4.50/dz |
| JOR180DE | 14g x 2", dz | \$4.50/dz |
| JOR180DG | 14g x 3", dz | \$4.50/dz |
| JOR180DH | 14g x 4", dz | \$4.50/dz |



Stainless Steel Hypodermic Needle JorVet

Stainless steel. Round hub. Packaged in cardboard box or plastic clear case. 12/pkg.



| | | |
|----------|-------------------|-----------|
| JOR174EC | 12g x 1" | \$6.60/dz |
| JOR174ED | 12g x 1 1/2" | \$6.60/dz |
| JOR174EE | 12g x 2" | \$6.60/dz |
| JOR174EG | 12g x 3" | \$6.60/dz |
| JOR174EH | 12g x 4" dzn | \$7.70/dz |
| JOR174DB | 14g x 3/4" | \$6.40/dz |
| JOR174DC | 14g x 1" | \$6.40/dz |
| JOR174DD | 14g x 1 1/2" | \$6.40/dz |
| JOR174DE | 14g x 2" | \$6.40/dz |
| JOR174DG | 14g x 3" | \$6.00/dz |
| JOR174DH | 14g x 4" | \$6.75/dz |
| JOR174CA | 16g x 1/2" | \$6.30/dz |
| JOR174CB | 16g x 3/4" | \$6.30/dz |
| JOR174CC | 16g x 1", 12/bx | \$6.30/dz |
| JOR174CD | 16g x 1.5", 12/bx | \$6.30/dz |
| JOR174CE | 16g x 2" | \$6.30/dz |
| JOR174CG | 16g x 3" | \$6.30/dz |
| JOR174CH | 16g x 4" | \$6.60/dz |
| JOR174BA | 18g x 1/2" | \$6.00/dz |
| JOR174BB | 18g x 3/4" | \$6.00/dz |
| JOR174BC | 18g x 1", 12/bx | \$6.00/dz |
| JOR174BD | 18g x 1.5", 12/bx | \$6.00/dz |
| JOR174BE | 18g x 2" | \$6.00/dz |
| JOR174BG | 18g x 3" | \$6.00/dz |
| JOR174BH | 18g x 4" | \$6.30/dz |
| JOR174AA | 20g x 1/2" | \$6.00/dz |
| JOR174AB | 20g x 3/4" | \$6.00/dz |
| JOR174AC | 20g x 1" | \$6.00/dz |
| JOR174AD | 20g x 1 1/2" | \$6.00/dz |
| JOR174AE | 20g x 2" | \$6.00/dz |



Hypodermic Needles

Premium Needles. German quality. Extra sharp reusable stainless steel. Round hub. Packaged in attractive clear plastic case. 10/pkg.



| 14 Gauge | | |
|----------|------------------|------------|
| JOR870DA | 14g x 1/2", 10pk | \$9.00/pk |
| JOR870DB | 14g x 3/4", 10pk | \$9.00/pk |
| JOR870DC | 14g x 1", 10pk | \$9.00/pk |
| JOR870DE | 14g x 2", 10pk | \$10.50/pk |
| JOR870DH | 14g x 4", 10pk | \$16.50/pk |

| 16 Gauge | | |
|----------|------------------|------------|
| JOR870CB | 16g x 3/4", 10pk | \$9.00/pk |
| JOR870CC | 16g x 1", 10pk | \$10.20/pk |
| JOR870CG | 16g x 3", 10pk | \$16.50/pk |
| JOR870CH | 16g x 4", 10pk | \$21.00/pk |
| 18 Gauge | | |
| JOR870BB | 18g x 3/4", 10pk | \$9.00/pk |
| JOR870BC | 18g x 1", 10pk | \$9.00/pk |



JorVet

13822 WEST BOULTON BLVD. METTAWA, IL 60045

Phone 800-544-7521

67

WWW.SHOPMEDVET.COM

Fax 800-204-2177

Syringes & Needles

JorVet Biopsy Needles



Franseen Style Biopsy Needle

Used to obtain core biopsy specimens for histology and impression smears. Attaches to standard syringe for aspiration. Cannula point design suitable for cutting difficult lesions. Also available in echogenic (ultrasound) tips. Sterile. Not autoclavable.

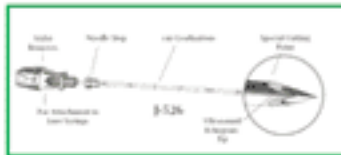

| | | |
|---------|------------------------------|------------|
| JOR526 | Unmarked Needle. 18g x 9cm.t | \$19.80/ea |
| JOR526B | Unmarked Needle. 20g x 9cm. | \$15.30/ea |
| JOR526C | Unmarked Needle. 22g x 15cm. | \$15.30/ea |

Franseen Style Biopsy Needle (Ultra Sound)

Used to obtain core biopsy specimens for histology and impression smears. Attaches to standard syringe for aspiration. Cannula point design suitable for cutting difficult lesions. Also available in echogenic (ultrasound) tips. Sterile. Not autoclavable. 

| | | |
|----------|----------------------------|------------|
| JOR526EA | Marked Needle. 18g x 15cm. | \$16.50/ea |
| JOR526EC | Marked Needle. 20g x 15cm. | \$22.50/ea |

Soft-Tissue Biopsy Needle

Long enough to reach any biopsy site. 1mm x 20mm specimen chamber.

| | | |
|--------|----------------------|------------|
| JOR118 | 14g x 41/2" L shaft. | \$21.00/ea |
|--------|----------------------|------------|



Rosenthal Bone Biopsy Needle

For use in bone marrow biopsy. Containing large spool luer lock hub, sharp pointed cannula and fitted stylet with matched bevel point. Autoclavable. 

| | | |
|----------|-------------------------------|------------|
| JOR116RA | Sterile, 12/pkg 18g x 1" | \$63.00/ea |
| JOR116RB | Sterile, 12/pkg 16g x 1 5/16" | \$63.00/ea |



Vin-Silverman Biopsy Needle

For use in bone marrow biopsy. Containing large spool luer lock hub, sharp pointed cannula and fitted stylet with matched bevel point. Autoclavable. 

| | | |
|----------|-------------------------------|-------------|
| JOR116VS | 14g x 2 3/8", Sterile, 12/pkg | \$194.00/ea |
|----------|-------------------------------|-------------|





FUS Needle

21g olive tipped needles are perfect for flushing of the small male feline urethra in cases of obstructive FLUTD. The blunt tip prevents trauma to the sensitive urethral lining. Rather than forcing struvite plugs back into the bladder with saline, it is suggested that JOR153w Walpole's solution is infused to dissolve away any crystal formation. Then a JOR153 series Jackson catheter is inserted to ensure urethral patency. Luer mount fits any syringe. Stainless steel. Autoclavable. Individually packaged.



| | | |
|---------|--------------|------------|
| JOR153C | 21g x 1/2" | \$18.00/ea |
| JOR153D | 21g x 1" | \$18.00/ea |
| JOR153E | 21g x 1 1/2" | \$18.00/ea |

True Cut Style Biopsy Needle

Long enough to reach any biopsy site. 1mm x 20mm specimen chamber. 

| | | |
|---------|------------------|------------|
| JOR118A | 18g x 10cm (4"). | \$21.60/ea |
| JOR118B | 18g x 10cm (4"). | \$21.60/ea |
| JOR118C | 18g x 10cm (4"). | \$21.60/ea |
| JOR118D | 18g x 10cm (4"). | \$25.50/ea |



Super Core Biopsy Needle

Sterile. Not autoclavable.

Features:

- Spring activated single handle operation
- Ideal lightweight design
- Echogenic tip for ultrasound visualization
- 20mm specimen notch
- Marked with cm graduations

| | | |
|---------|------------|------------|
| JOR528 | 14g x 9cm | \$36.00/ea |
| JOR528A | 16g x 9cm | \$36.00/ea |
| JOR528B | 16g x 15cm | \$36.00/ea |
| JOR528C | 18g x 9cm | \$36.00/ea |



Osty Core Bone Biopsy Needle

For taking core samples of bone (i.e. suspected osteosarcoma). Sterile. Not autoclavable. NOTE: Not for bone marrow aspirates.

| | | |
|---------|-------------------|------------|
| JOR116C | 16g x 7.5cm (3"). | \$55.50/ea |
|---------|-------------------|------------|



Syringes & Needles

Jorvet Needles

Chiba Style Biopsy Needle (Unmarked Needle)

General purpose aspiration biopsy needle. Short bevel removes sample from controlled area. Attaches to standard syringe. Small sizes for fine needle aspirates. Echogenic enhanced tip (ultrasound) available. Sterile. Not autoclavable. **Jorvet**

| | | |
|----------|------------------|------------|
| JOR527 | 18g x 9cm | \$12.60/ea |
| JOR527A | 18g x 15cm | \$12.75/ea |
| JOR527AB | 18g x 20cm, (8") | \$13.20/ea |
| JOR527B | 20g x 9cm | \$14.40/ea |
| JOR527D | 22g x 9cm | \$11.25/ea |
| JOR527E | 22g x 15cm | \$14.40/ea |



Chiba Ultrasound Biopsy Needle, Echogenic Enhanced Tip (Ultrasound)

General purpose aspiration biopsy needle. Short bevel removes sample from controlled area. Attaches to standard syringe. Small sizes for fine needle aspirates. Echogenic enhanced tip (ultrasound) available. Sterile. Not autoclavable.

| | | |
|----------|------------|------------|
| JOR527EA | 18g x 15cm | \$14.40/ea |
| JOR527EB | 20g x 9cm | \$13.50/ea |
| JOR527EC | 20g x 15cm | \$15.75/ea |
| JOR527ED | 22g x 9cm | \$13.50/ea |



Jorvet Lateral Flow Vented Needle

| | | |
|--------|--------|------------|
| JOR593 | 10/pkg | \$10.50/ea |
|--------|--------|------------|

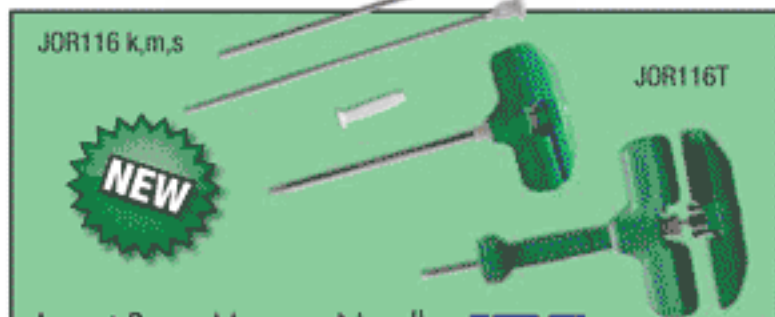

Jorvet Bone Marrow Needle **Jorvet**

Large hand grip for increased torque. Adjustable depth stop from 3/8" to 1 7/8" shaft. Luer lock syringe attachment. Similar to Jamshidi style. Can also be used for intraosseous fluid administration. Sterile. Green. Not autoclavable.

| | | |
|---------|-----------------------|------------|
| JOR116T | 16 gauge, regular tip | \$21.00/ea |
|---------|-----------------------|------------|

Bone Marrow Biopsy/Aspiration

These bone marrow needles allow for an actual biopsy versus the aspiration other needles provide. A special reamer is included to allow retrieval of actual tissue sample. Notice the difference in tip design, a double-side diamond. Not autoclavable. Sterile. **Jorvet**

| | | |
|---------|--------------------------------|------------|
| JOR116K | 8g x 4" | \$40.50/ea |
| JOR116M | 11g x 4" | \$40.50/ea |
| JOR116S | 13g x 4" (reamer not included) | \$30.00/ea |

Jorvet Spinal Needles

Spinal Needle. General purpose aspiration biopsies and drainage procedures. Matched ground bevel eliminates possibility of tissue coring. Attaches to standard luer fitting. Available with echogenic enhanced tip (ultra-sound). Not autoclavable. Sterile.



| | | |
|---------|-------------------------------------|------------|
| JOR529A | Unmarked Needle, 18g x 15cm (6") | \$10.50/ea |
| JOR529B | Unmarked Needle, 20g x 9cm (3 3/4") | \$10.50/ea |
| JOR529C | Unmarked Needle, 20g x 15cm (6") | \$10.50/ea |

| | | |
|----------|---|------------|
| JOR529EB | Echogenic Tip.w/ultrasound tip, 20g x 9cm (33/4") | \$12.30/ea |
| JOR529ED | Echogenic Tip.w/ultrasound tip, 22g x 9cm | \$15.00/ea |

Irrivet Wound Irrigation Syringe Kit

IRRIVET is a unique, spring-loaded, self-refilling system that quickly and easily irrigates contaminated wounds. Simple, one-hand, thumb-controlled pressure provides a forceful 7.6 psi stream directly to the desired area (or a gentler stream if needed). The soft flexible tip has an inside diameter equivalent to an 18-19 gauge needle. The soft, flexible 23/4" tip eliminates needlesticks for the user and minimizes trauma to the patient. Tip length can be trimmed. Concave Splitter-Gard™ prevents contamination from body secretions. The 6" tubing attaches to a standard IV bag.

| | | |
|--------|------------|------------|
| JOR754 | 2 3/4" tip | \$22.80/ea |
|--------|------------|------------|



Intraosseous Infusion Needle

Intraosseous infusion is an excellent option when vascular access is difficult. Fluids and most IV drugs can be administered in this fashion. This method is mainly used in small animals and birds where blood vessels are small to begin with. The most common site of placement is the proximal femur. The point of entry for the canula is the trochanteric fossa. This method is for short time use and an IV catheter should be placed as soon as possible.

| | | |
|---------|-----------------------------|------------|
| JOR116Q | Sterile, 12/pkg 18g x 3.5cm | \$19.80/ea |
|---------|-----------------------------|------------|



Blunt End Needle, Jorgensen

Without olive tip. Stainless steel shaft and luer lock fitting.

| | | |
|----------|------------------|------------|
| JOR156D | 23g x 1" (2.5cm) | \$9.00/ea |
| JOR156DS | 30g x 1" (2.5cm) | \$13.20/ea |

Special tip for easy insertion into lacrimal duct. Luer mount fits any syringe. Olive tip. Stainless steel.

| | | |
|----------|------------------------|------------|
| JOR156DC | blunt tip, 23g, curved | \$12.00/ea |
|----------|------------------------|------------|



Syringes & Needles

Jorvet Needles

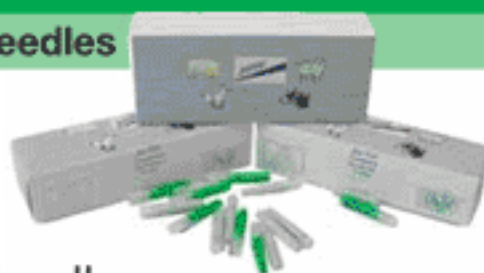

Thunderbolt Aluminum Hub Hypodermic Needles

Aluminum hub hypodermic needles with stainless steel needle cannulas are especially designed for the demands of injecting large animals. The needles are razor sharp and individually packaged in their own disposable two-piece cartridges. Sterile. 100/pkg.

Features:

- Color coded by gauge
- Marked with needle gauge and length
- Competitively priced

| | | |
|---------|------------|------------|
| JOR971 | 20g x 1/2" | \$14.20/bx |
| JOR972 | 20g x 1" | \$14.20/bx |
| JOR956 | 14g x 3/4" | \$14.20/bx |
| JOR965B | 18g x 1/2" | \$14.00/bx |



Loopuyt's Needle

For taking core samples of bone (i.e. suspected osteosarcoma). Sterile. Not autoclavable.

| | | |
|---------|----------------------------|------------|
| JOR177A | Loopuyt's Needle #1, dozen | \$25.50/dz |
| JOR177B | Loopuyt's Needle #3, dozen | \$25.50/dz |
| JOR177C | Loopuyt's Needle #5, dozen | \$25.50/dz |



8 Blunt 19g Needles

The anal sac excision kit employs a hot liquefied gel injected in to the sac. The gel is in a 2ml cartridge that is first boiled to a liquid and loaded in a specially designed syringe. Then, via a 19g blunt needle, is injected into each anal sac. The gel then hardens and gives the sac a readily defined and easily dissected shape for quick removal.

| | |
|----------|------------|
| JOR101D3 | \$11.70/pk |
|----------|------------|

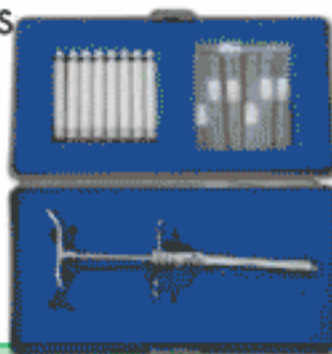

Double End Transfer Needle

Double ended transfer needle. One end is a 1/2" 17g needle and the other end is a 1" x 19g needle. Sterile. The best choice for rehydrating solutions.

JOR173S Sterile, 12/pkg.

\$21.25/dz



Transfer Needle Double Pointed

Double Pointed

JOR173 Stainless steel, 16g x 1 1/4", 12/pkg.

\$39.00/dz

Transfer Needle

has a concave metal plate where the finger can steady the transfer needle during mixing. Stainless steel, 14g x 3". Packaged in plastic vial.

JOR173T Sterile, 12/pkg

\$0.80/pk



Lacrimal Needle

Special tip for easy insertion into lacrimal duct. Luer mount fits any syringe. Olive tip. Stainless steel.

| | | |
|----------|--|------------|
| JOR156CA | Curved, 0.60mm x 30mm (~23g). | \$18.00/ea |
| JOR156A | Straight, 0.60mm x 30mm (~23g). | \$15.00/ea |
| JOR156F | Straight, 23g x 3/4" (~2cm) reinforced shaft 1/2" (1.3cm) extension. | \$15.00/ea |



Blunt End Needle

Blunt tip needles. These blunt end needles have a wide range of applications around the clinic including:

- Anal sac irrigation.
- Wound flushing.
- Lacrimal duct flush.
- Male cat urethral flush.
- Feeding needle.

These blunt ends have a polished straight stainless cannula with a polypropylene color-coded hub. Non-sterile 5 pack



| | | |
|----------|--------------------------|-----------|
| JOR1032 | 14g x 1 1/2", Green, 5pk | \$5.50/pk |
| JOR1032A | 14g x 1", Green, 5pk | \$5.90/pk |
| JOR1032B | 16g x 1 1/2", Gray, 5pk | \$6.90/pk |
| JOR1032C | 16g x 1", Gray, 5pk | \$5.90/pk |

| | | |
|----------|--------------------------|-----------|
| JOR1032D | 18g x 1 1/2", Green, 5pk | \$5.30/pk |
| JOR1032E | 18g x 1", Green, 5pk | \$5.90/pk |
| JOR1032F | 22g x 1 1/2", Blue, 5pk | \$4.80/pk |
| JOR1032G | 22g x 1", Blue, 5pk | \$5.40/pk |
| JOR1032H | 22g x 1/2", Blue, 5pk | \$4.75/pk |

| | | |
|----------|--------------------------|-----------|
| JOR1033 | 15g x 1 1/2", Brown, 5pk | \$7.90/pk |
| JOR1033A | 15g x 1/2", Brown, 5pk | \$5.90/pk |
| JOR1033B | 18g x 1 1/2", Green, 5pk | \$5.90/pk |
| JOR1033C | 18g x 1/2", Green, 5pk | \$5.90/pk |
| JOR1033D | 20g x 1 1/2", Pink, 5pk | \$8.40/pk |
| JOR1033E | 20g x 1/2", Pink, 5pk | \$5.90/pk |
| JOR1033F | 25g x 1 1/2", Red, 5pk | \$5.90/pk |
| JOR1033G | 25g x 1/2", Red, 5pk | \$5.90/pk |

| | | |
|----------|------------------------|-------------|
| JOR1032J | 25g x 1 1/2", Red, 5pk | \$5.60/pk |
| JOR1032K | 25g x 1", Red, 5pk | \$5.50/pk |
| JOR1032M | 25g x 1/2", Red, 5pk | \$5.25/pk |
| JOR1032N | 30g x 1/2", Pink, 5pk | \$4.90/pk |
| JOR1032X | kit, 26 needles | \$26.00/set |



Blunt tip needles. **Straight but flexible.** Have a polypropylene burr free shaft with poly hub 5 pack non-sterile.

13822 WEST BOULTON BLVD. METTAWA, IL 60045

Phone 800-544-7521

70

WWW.SHOPMEDVET.COM

Fax 800-204-2177

HI-TECH GERMAN SURGICAL INSTRUMENTS

LIFETIME WARRANTY

We guarantee every HI-TECH surgical instrument to be free of functional defects in workmanship and materials. HI-TECH promises to repair or replace, free of charge, any surgical instrument that does not meet these requirements when used for their intended surgical purpose.

HI-TECH promises to repair instruments that have been abused or subjected to abnormal use for a small surcharge.

Warranty Applies to Hi-Tech German Instruments only not Jorgensen German Instruments

CARE AND HANDLING

With proper care and handling, HI-TECH instruments will last for years. Please use these guidelines for all HI-TECH stainless steel instruments.

- Brand new instruments should be cleaned prior to first sterilization.
- Contaminated instruments should be processed as soon as possible.
- Stubborn protein particles can be removed with a scrub brush. Never use steel wool, abrasives or an acid rinse.
- Open joints on instruments prior to preparation
- Do not use multipurpose detergents to wash or soak instruments. Instead, use a low-suds detergent specifically designed for instruments. (re-order #LSD) The pH of the product should never be higher than 8.
- When using ultrasonics, a detergent with a pH of either 6, 7 or 8 must be used.
- Lubrication is vital to a long instrument life. We recommend a water soluble instrument milk (re-order #ILG)
- Avoid silicone lubricants because they tend to build up and mix with debris to clog moving parts, which becomes almost impossible to remove.
- Debris buildup can have a "rust-like" appearance.
- Rinse your cleaned instruments in demineralized water. Be sure to remove all residual cleaning compounds before sterilization, as they can cause stains.
- Dry the instrument thoroughly after rinsing.

INSTRUMENT CHECK-UP

The best time to check your instruments is after they have been cleaned, lubricated, and have cooled off.

Please check the following:

1. FUNCTION:

Splitters, nippers and scissors must cut cleanly (resharpen if needed) and close properly.

Needle holders and clamps must engage properly and meet correctly at the tips.

Instruments which have been dropped or otherwise damaged should be inspected carefully for cracking, bent tips or breakage.

2. SURFACE:

Inspect the surface for any signs of staining or other irregularity. If you find any staining, investigate the source and avoid it in the future.

SOME COMMON SOURCES OF STAINING ARE:

Inadequate cleaning, mixing dissimilar metals, water impurities, unsuitable or improper preparation and usage of cleaning and disinfecting or maintenance agents, Non-Compliance with operating procedures of cleaning and sterilizing equipment.

Storage

Allow instruments to dry thoroughly before storing them in a clean, dry environment. Never store them in an area where chemicals may emit corrosive vapors or where temperature and moisture variations may cause condensation on the instruments.

Quick Checklist

1. Rinse soiled instruments immediately. Thoroughly clean before autoclaving.
2. Autoclave and sterilize instruments in an open position.
3. Do not pile up or entangle instruments.
4. Follow the recommendations of the equipment and solution manufacturers.
5. Keep instruments properly lubricated.
6. Inspect instruments regularly.

Instrument Care & Protection Guide

The high grade instruments you own represent a considerable investment. The following guide will help you protect this investment and should enable you to receive many years of use from your instruments. All Hi-Tech German, stainless steel, surgical instruments are made of corrosion resistant, high grade, specialty steels which can meet the varying requirements of cutting, clamping, retracting, chiselling, etc. One of the special characteristics of these steels is that they form passive layers on the surface which protects against corrosion. These layers can be thought of as an invisible patina. With repeated use and exposure to the air, this oxidation process continues, making the instrument even more corrosion resistant with proper maintenance. However, a word of caution is in order: While every effort is made in the manufacturing process to make the instruments corrosion resistant, you must do your part by treating them properly. If not, the steel can rust or stain, reducing the life of the instrument or even rendering it useless. In a sense, the word "stainless" is a misnomer and should not be taken literally. Later in this guide we will discuss the most common problems encountered with instrument maintenance.

Proper Usage

Instruments are designed for a particular purpose and they should be used for only that purpose. It is important to choose the proper instrument for the task to be accomplished. For instance, a nail splitter should not be used to cut wire.

Water

Because tap water contains many minerals which may cause discoloration and staining, we recommend the use of distilled water for cleaning, disinfecting, sterilizing and rinsing instruments. To avoid staining, use a cleaning solution with a pH near neutral (7). If you do use tap water for rinsing, please make sure you dry the instrument thoroughly to avoid stains.

Brand New Instruments

Newly purchased instruments must be cleaned, lubricated and autoclaved before use.

Manual Cleaning

When handling instruments be very careful not to damage their fine tip and mechanisms. If instruments have been exposed to blood, tissue, saline or other foreign matter, you must rinse them in warm (not hot) water before these substances are allowed to dry. After rinsing, immerse them in a cleaning solution. A number of compounds, such as certain chemicals, are highly corrosive to stainless steel. To be on the safe side, rinse and dry instruments immediately in case they have come in contact with any potentially harmful substances. If no ultrasonic cleaner is available, clean the instrument very carefully. Pay particular attention when cleaning the boxlocks, serrations, hinges and all other hard to reach areas. Use nylon (not steel) brushes (such as a toothbrush), and warm (not hot) cleaning solutions.

Follow the manufacturer's instruction for preparation of cleaning solutions. Change these solutions daily!

Ultrasonic Cleaning

This is by far the most effective and most efficient way to clean your instruments. Follow the manufacturer's recommendation for mixing the solution and the duration of the cleaning cycle.

Before putting soiled instruments into an ultrasonic cleaner, we recommend that they be cleaned in a cleaning solution, of all visible debris clinging to them.

Please observe the following:

1. Do not mix dissimilar metals (like chrome and stainless) in the same cycle.
2. Open all instruments so ratchets and boxlocks are accessible.
3. When loading, avoid piling instruments on top of each other. This could damage delicate instruments.
4. After the cycle is finished, remove the instruments, rinse and dry them off immediately.
5. Also allow them to air dry thoroughly.

Lubrication and Autoclaving

Remember, autoclaving is no substitute for cleaning. If the instruments are not thoroughly cleaned beforehand, irreparable damage may occur during the autoclaving process. Before autoclaving, lubricate all instruments with moving parts, such as boxlocks and hinges. Use instrument milk or surgical lubricants, not industrial oils. Always sterilize instruments in an open or unlocked position. DO NOT overload the chamber and be sure to stack the instruments carefully so no damage occurs to the delicate instruments.

It is recommended that the instruments be wrapped in cloth inside the container or that a cloth be placed on the bottom of the pan to absorb moisture. The cloth should be pH (7) neutral and have no residue of detergents. During and after the drying cycle, avoid cooling the instrument suddenly. This can happen when a rush of cold air enters the autoclave chamber or when the hot instruments are placed on a cool, metal surface. If this happens, condensation can occur which may result in the staining of the instruments.

Cold Sterilization and Disinfection

Prolonged immersion in disinfection or sterilization solution can be detrimental to surgical instruments. We recommend that you do not immerse the instruments longer than twenty minutes. To render the instruments sterile and ready for use, we recommend the use of an autoclave cycle. This saves time and is more gentle to the instruments. Rinse and dry instruments thoroughly after disinfection.

GERMAN SPAY PACKS

LIFETIME WARRANTY*



The Canine Spay Pack includes 18 stainless steel instruments. Available in three grades: Economy, Hi-Tech and Integra/Integra/Miltex.

- 1 Mayo Scissors 6 3/4" straight
- 1 #3 Scalpel/Blade Handle
- 1 Snook Hook 8"
- 2 Kelly Hemostat Forceps 5 1/2" curved
- 1 Metzenbaum Scissor, 5 1/2" curved
- 1 Tissue Forceps, 5 1/2", 1 x 2 teeth
- 4 Backhaus Towel Forceps 3 1/2"
- 1 Olsen-Hegar Needle Holder 6 1/2"
- 1 Adson-Brown Forceps 4 3/4" 7x7
- 1 Allis Forceps 6" 4x5
- 2 Halstead Mosquito Forceps, 5" curved
- 2 Rochester-Carmalt Forceps, 6.25" curved

HI-TECH
FINEST QUALITY
GERMAN SURGICAL
INSTRUMENTS

*German
Instruments Only

Canine Spay Pack

| | | | |
|------------|----------------|---------------|--|
| CSPAY-GER | 18 Instruments | \$291.99/ea | GERMAN WITH LIFETIME WARRANTY |
| CSPAY-ECON | 18 Instruments | \$39.95/ea | ECONOMY |
| CSPAY-MIL | 18 Instruments | \$1,163.80/ea | Integra/Miltex WITH LIFETIME WARRANTY |

The Feline Spay Pack includes 18 stainless steel instruments. Available in three grades: Economy, Hi-Tech and Integra/Miltex.

- 1 Mayo Scissors 6 3/4" straight
- 1 #3 Scalpel/Blade Handle
- 1 Snook Hook 8"
- 2 Kelly Hemostat Forceps 5 1/2" curved
- 1 Metzenbaum Scissor, 5 1/2" curved
- 1 Tissue Forceps, 5 1/2", 1 x 2 teeth
- 4 Backhaus Towel Forceps 3 1/2"
- 1 Olsen-Hegar Needle Holder 5 1/2"
- 1 Adson-Brown Forceps 4 3/4" 7x7
- 1 Allis Forceps 6" 4x5
- 2 Halstead Mosquito Forceps, 5" curved
- 2 Rochester-Carmalt Forceps, 6.25" curved

HI-TECH
FINEST QUALITY
GERMAN SURGICAL
INSTRUMENTS

*German
Instruments Only

Feline Spay Pack

| | | | |
|------------|----------------|---------------|--|
| FSPAY-GER | 18 Instruments | \$291.99/ea | GERMAN WITH LIFETIME WARRANTY |
| FSPAY-ECON | 18 Instruments | \$39.95/ea | ECONOMY |
| FSPAY-MIL | 18 Instruments | \$1,158.89/ea | Integra/Miltex WITH LIFETIME WARRANTY |

**SEE THE END OF THIS SECTION For A Full Assortment
Of Genral and Specialized Instrument Packs**

13822 WEST BOULTON BLVD. METTAWA, IL 60045

Phone 800-544-7521

7/3

WWW.SHOPMEDVET.COM

Fax 800-204-2177

Surgical Blades & Handles



Stainless Steel Surgical Blades

| Vendor | Item# | Details | Price |
|------------------|-------------|-------------|------------|
| VARIOUS | 10SS | #10, 100/bx | \$13.95/bx |
| | 11SS | #11, 100/bx | \$13.95/bx |
| | 12SS | #12, 100/bx | \$13.95/bx |
| | 15SS | #15, 100/bx | \$13.95/bx |
| | 20SS | #20, 100/bx | \$13.95/bx |
| | 21SS | #21, 100/bx | \$13.95/bx |
| | 22SS | #22, 100/bx | \$13.95/bx |
| | 23SS | #23, 100/bx | \$13.95/bx |
| 24SS | #24, 100/bx | \$13.95/bx | |
| JORGENSEN | JOR580S | #10, 100-pk | \$14.60/bx |
| | JOR581S | #11, 100-pk | \$14.60/bx |
| | JOR582S | #12, 100-pk | \$14.60/bx |
| | JOR583S | #15, 100-pk | \$14.60/bx |
| | JOR584S | #20, 100-pk | \$14.60/bx |
| | JOR585S | #21, 100-pk | \$14.60/bx |
| JOR586S | #22, 100-pk | \$14.60/bx | |

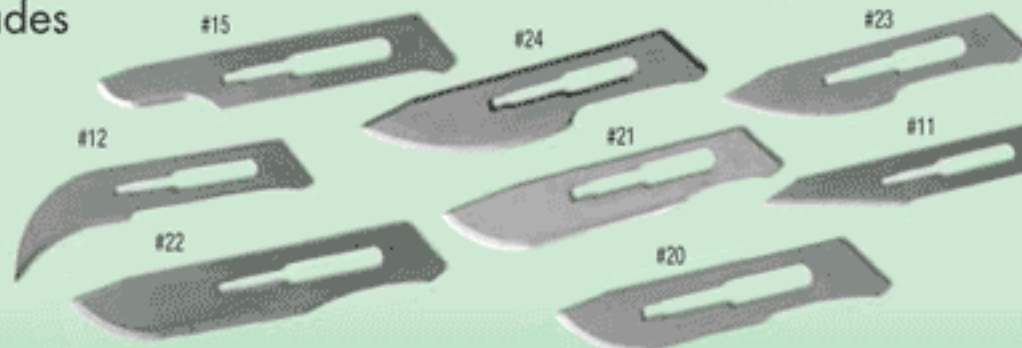

Carbon Steel Surgical Blades

| Item# | Details | Price | Item# | Details | Price |
|-------|-------------|-----------|-------|-------------|-----------|
| #10 | #10, 100/bx | \$9.95/bx | #20 | #20, 100/bx | \$9.95/bx |
| #11 | #11, 100/bx | \$9.95/bx | #21 | #21, 100/bx | \$9.95/bx |
| #12 | #12, 100/bx | \$9.95/bx | #22 | #22, 100/bx | \$9.95/bx |
| #15 | #15, 100/bx | \$9.95/bx | #23 | #23, 100/bx | \$9.95/bx |
| | | | #24 | #24, 100/bx | \$9.95/bx |

Chisel Blades

| | | |
|------|-------|-----------|
| #312 | 12/bx | \$9.95/bx |
| #313 | 12/bx | \$9.95/bx |
| #314 | 12/bx | \$9.95/bx |
| #316 | 12/bx | \$9.95/bx |



Mini Blades

| | | |
|-------|-------------|-----------|
| #6100 | #6100 12/bx | \$9.95/bx |
| #6200 | #6200 12/bx | \$9.95/bx |
| #6400 | #6400 12/bx | \$9.95/bx |
| #6700 | #6700 12/bx | \$9.95/bx |



Micro Scalpel Blades

| Vendor | Item# | Details | Price |
|------------------|-----------|-------------------------------------|------------|
| JORGENSEN | JOR891 | #64 Micro Scalpel Blade, 25 pk | \$52.00/ea |
| | JOR891AXS | #65 blades (extra small #11), 25/pk | \$62.00/ea |
| | JOR891A | #65 Micro Scalpel Blade, 25/pk | \$52.00/ea |
| | JOR890 | Handle Only, 25/bx | \$13.50/ea |



Scalpel Handles

RULER ON INTEGRA/MILTEX ONLY!

| Vendor | Item# | Details | Price |
|------------------|---------|--------------------------------|------------|
| ECONOMY | 6-450 | #3, fits blades #10-#15 | \$1.50/ea |
| | 6-455 | #4, fits blades #20-#24 | \$2.00/ea |
| | 6-460 | #7, fits blades #10-#15 | \$3.00/ea |
| MID GRADE | 6-460-S | #7, Satin Finish | \$6.00/ea |
| GERMAN | 06-100 | #3, 5", fits blades #10-#15 | \$6.49/ea |
| | 06-102 | #4, 5.25", fits blades #20-#24 | \$6.49/ea |
| | 06-104 | #7, 6.5", fits blades #10-#15 | \$10.99/ea |
| JORGENSEN | JOR55A | | \$2.60/ea |
| | JOR55B | | \$2.70/ea |
| | JOR55GA | German-made, Size #3 | \$6.90/ea |
| | JOR55GB | German-made, Size #4 | \$6.90/ea |
| MILTEX | MIL4-7 | #3, fits blades #10-#15 | \$18.30/ea |
| | MIL4-8 | #4, fits blades #20-#24 | \$18.30/ea |
| | MIL4-9 | #7, fits blades #10-#15 | \$29.95/ea |



Mini and Chisel Blade Handles

| | | |
|--------|--------------------------|------------|
| 36-100 | 6" Mini Blades | \$12.00/ea |
| 36-101 | 6.25" Mini Blades | \$12.00/ea |
| #13 | 4" Mini Blades | \$9.95/ea |
| #13L | 5.25" Mini Blades | \$9.95/ea |
| #14P | 4.25" Fits Chisel Blades | \$9.95/ea |



Plastic Scalpel Handle

| Vendor | Item# | Details | Price |
|------------------|---------|---------|-----------|
| JORGENSEN | JOR55FB | Size #4 | \$4.20/ea |
| | JOR55PA | Size #3 | \$4.20/ea |



Folding Scalpel Handle

| Vendor | Item# | Details | Price |
|------------------|----------|---------|-----------|
| JORGENSEN | JOR55FA | Size #3 | \$6.00/ea |
| | JOR55FFB | Size #4 | \$6.00 |



Disposable Scalpels & Suture Needles

Disposable Scalpels

| Vendor | Item# | Details | Price |
|----------------|-------|------------|-----------|
| Economy | DS10 | #10, 10/bx | \$7.00/bx |
| | DS11 | #11, 10/bx | \$7.00/bx |
| | DS12 | #12, 10/bx | \$7.00/bx |
| | DS15 | #15, 10/bx | \$7.00/bx |
| | DS20 | #20, 10/bx | \$7.00/bx |
| | DS21 | #21, 10/bx | \$7.00/bx |
| | DS22 | #22, 10/bx | \$7.00/bx |

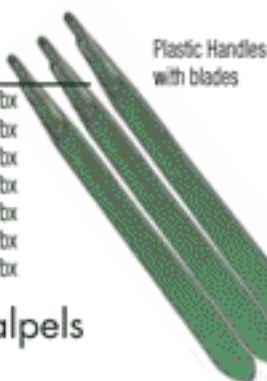

Disposable Stainless Steel Scalpels (Stainless Steel)

| Vendor | Item# | Details | Price |
|------------------|--------|------------|-----------|
| JORGENSEN | JORS80 | #10, 10-pk | \$7.10/bx |
| | JORS81 | #11, 10-pk | \$7.10/bx |
| | JORS82 | #12, 10-pk | \$7.10/bx |
| | JORS83 | #15, 10-pk | \$7.10/bx |
| | JORS84 | #20, 10-pk | \$7.10/bx |
| | JORS85 | #21, 10-pk | \$7.10/bx |
| | JORS86 | #22, 10-pk | \$6.80/bx |



Swann-Morton Disposable Scalpel

| Vendor | Item# | Details | Price |
|------------------|---------|------------------|-----------|
| JORGENSEN | JORS5DA | size #10, 10/box | \$9.90/bx |
| | JORS5DB | size #11, 10/box | \$9.90/bx |
| | JORS5DC | size #12, 10/box | \$9.90/bx |
| | JORS5DD | size #15, 10/box | \$9.90/bx |
| | JORS5DE | size #20, 10/box | \$9.90/bx |
| | JORS5DF | size #21, 10/box | \$9.90/bx |
| | JORS5DG | size #22, 10/box | \$9.90/bx |



Reverse Cutting Suture Needles

Choose from a full selection of needles for all veterinary needs. Sizes available include 2, 4, 6, 8, 10, 11, 12, 13, 14, 16, 18 and 20 in 3/8-circle. 12/pk. Price is for (1) **12/pk of ONE SIZE ONLY**

| | | |
|-----------|---|-----------|
| JOR7011 | 3/8 circle, dozen | \$9.30/dz |
| JOR7031 | 1/2 circle, dozen | \$9.30/dz |
| JOR7031XL | 3/8-circle, 3 1/4". Extra heavy needles for bovine and equine use. 12/pk. | \$27.00 |

Jorvet

12/pk of ONE SIZE ONLY
Please specify size when ordering.

Taper Suture Needles

Choose from a full selection of needles for all veterinary needs. Sizes available include 2, 4, 6, 8, 10, 11, 12, 13, 14, 16, 18 and 20 in 3/8-circle and 1/2-circle models. 12/pk. Price is for (1) **12/pk of ONE SIZE ONLY**

| | | |
|-----------|---|------------|
| JOR6017 | 3/8 circle, dozen | \$9.30/dz |
| JOR6037 | 1/2 circle, dozen | \$9.30/dz |
| JOR6037XL | 3/8-circle, 3 1/4". Extra heavy needles for bovine and equine use. 12/pk. | \$30.00/pk |

Jorvet

12/pk of ONE SIZE ONLY
Please specify size when ordering.

| 3/8" CIRCLE | | | | | | | | | | | |
|-------------|------|------|------|------|------|------|------|------|------|------|------|
| 2 | 4 | 6 | 8 | 10 | 11 | 12 | 13 | 14 | 16 | 18 | 20 |
| 55mm | 49mm | 43mm | 39mm | 33mm | 31mm | 28mm | 26mm | 25mm | 22mm | 20mm | 17mm |

| 1/2" CIRCLE | | | | | | | | | | | |
|-------------|------|------|------|------|------|------|------|------|------|------|------|
| 2 | 4 | 6 | 8 | 10 | 11 | 12 | 13 | 14 | 16 | 18 | 20 |
| 45mm | 40mm | 35mm | 29mm | 26mm | 25mm | 23mm | 22mm | 19mm | 17mm | 15mm | 13mm |



Needle Rack **Jorvet**

Convenient spring action model for holding suture needles.

JOR105R \$15.00/ea



Needle Sterilization Rack

MIL3-50 \$28.88/ea **MILTEX**

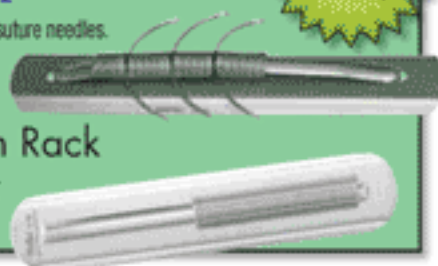

Blade-Safe Surgical Blade Remover

| Vendor | Item# | Details | Price |
|-----------------------|----------|--|------------|
| Integra/Miltex | MIL4-100 | safely removes blades from handles, protecting hands | \$18.31/ea |

Integra/Miltex Suture Needles

12/pk of ONE SIZE ONLY
Please specify size when ordering.

1/2 Circle Taper Point Needle

Regular Surgeon's Needles, 1/2 circle, taper point

| | | |
|-------------|----------------------|-------------|
| MIL-192A-10 | Size 10, 35mm, 12/pk | \$10.95 /Pk |
| MIL-192A-12 | Size 12, 29mm, 12/pk | \$10.95 /Pk |
| MIL-192A-14 | Size 14, 24mm, 12/pk | \$10.95 /Pk |
| MIL-192A-16 | Size 16, 22mm, 12/pk | \$10.95 /Pk |
| MIL-192A-18 | Size 18, 18mm, 12/pk | \$10.95 /Pk |
| MIL-192A-20 | Size 20, 13mm, 12/pk | \$10.95 /Pk |



1/2 Circle Cutting Edge Needle

Regular Surgeon's Needles, 1/2 circle, cutting edge

| | | |
|------------|----------------------|-------------|
| MIL-192-10 | Size 10, 35mm, 12/pk | \$10.95 /Pk |
| MIL-192-12 | Size 12, 29mm, 12/pk | \$10.95 /Pk |
| MIL-192-14 | Size 14, 24mm, 12/pk | \$10.95 /Pk |
| MIL-192-16 | Size 16, 22mm, 12/pk | \$10.95 /Pk |
| MIL-192-18 | Size 18, 18mm, 12/pk | \$10.95 /Pk |
| MIL-192-20 | Size 20, 13mm, 12/pk | \$10.95 /Pk |



3/8 Circle Taper Point Needle

Regular Surgeon's Needles, 3/8 circle, round body, taper point

| | | |
|-------------|----------------------|-------------|
| MIL-140A-10 | Size 10, 35mm, 12/pk | \$10.95 /Pk |
| MIL-140A-12 | Size 12, 29mm, 12/pk | \$10.95 /Pk |
| MIL-140A-14 | Size 14, 24mm, 12/pk | \$10.95 /Pk |
| MIL-140A-16 | Size 16, 22mm, 12/pk | \$10.95 /Pk |
| MIL-140A-18 | Size 18, 18mm, 12/pk | \$10.95 /Pk |
| MIL-140A-20 | Size 20, 13mm, 12/pk | \$10.95 /Pk |



3/8 Circle Cutting Edge Needle

Regular Surgeon's Needles, 3/8 circle, cutting edge, reverse cutting

| | | |
|------------|----------------------|------------|
| MIL-140-10 | Size 10, 35mm, 12/pk | \$10.95/Pk |
| MIL-140-12 | Size 12, 29mm, 12/pk | \$10.95/Pk |
| MIL-140-14 | Size 14, 24mm, 12/pk | \$10.95/Pk |
| MIL-140-16 | Size 16, 22mm, 12/pk | \$10.95/Pk |
| MIL-140-18 | Size 18, 18mm, 12/pk | \$10.95/Pk |
| MIL-140-20 | Size 20, 13mm, 12/pk | \$10.95/Pk |



Integra/Miltex **Needle Sizes**

| | | | | | |
|------|------|------|------|------|------|
| 10 | 12 | 14 | 16 | 18 | 20 |
| 35mm | 29mm | 24mm | 22mm | 18mm | 13mm |

13822 WEST BOULTON BLVD. METTAWA, IL 60045

Phone 800-544-7521

75

WWW.SHOPMEDVET.COM

Fax 800-204-2177

Needles and Needle Holders



Aesculap Mayo Hegar Needle Holder



| Vendor | Item# | Details | Price |
|------------------|---------|---|-------------|
| JORGENSEN | JOR661 | Tungsten Carbide Inserts, Gold-plated Rings, Combination Scissors, 5 1/2" | \$105.00/ea |
| | JOR661A | Tungsten Carbide Inserts, Gold-plated Rings, 6 1/2" | \$114.00/ea |

Aesculap Olsen Hegar Needle Holder (w/Scissors)

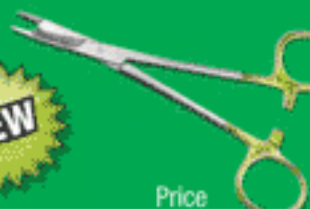

| Vendor | Item# | Details | Price |
|------------------|---------|---|-------------|
| JORGENSEN | JOR660 | Tungsten Carbide Inserts, Gold-plated Rings, Combination Scissors, 5 1/2" | \$132.00/ea |
| | JOR660A | Tungsten Carbide Inserts, Gold-plated Rings, Combination Scissors, 6 1/2" | \$135.00/ea |

Jorvet

Baumgartner Needle Holder



| Vendor | Item# | Details | Price |
|-----------------------|-----------|------------------|------------|
| ECONOMY | 11-1195 | 5" | \$3.95/ea |
| MID GRADE | 11-1195-S | 5", Satin Finish | \$6.95/ea |
| GERMAN | 12-105 | 5.25" | \$25.00/ea |
| INTEGRA/MILTEX | MIL8-40 | 5.25" | \$92.79/ea |

Crile Wood Needle Holder



| Vendor | Item# | Details | Price |
|------------------|--------|----------------------------------|------------|
| ECONOMY | 4-534 | 6" | \$2.95/ea |
| GERMAN | 12-113 | 6" | \$35.00/ea |
| | 12-114 | 8" | \$35.00/ea |
| JORGENSEN | JOR78X | Tungsten Carbide Jaws, 6" (15cm) | \$49.50/ea |

Castroviejo Needle Holder

Jorvet



| Vendor | Item# | Details | Price |
|------------------|---------|-----------------|------------|
| JORGENSEN | JOR231E | 5 1/2", Economy | \$45.00/ea |
| | JOR231 | 5 1/2", Economy | \$90.00/ea |

Keith Needle

Triangular cutting point

| Vendor | Item# | Price |
|------------------|----------|-----------|
| JORGENSEN | JOR7050A | \$5.40/pk |
| | JOR7050B | \$5.40/pk |
| | JOR7050C | \$5.40/pk |
| | JOR7050D | \$5.40/pk |
| | JOR7050E | \$5.40/pk |
| | JOR7050E | \$9.00/pk |



Derf Needle Holder

| Vendor | Item# | Details | Price |
|-----------------------|-----------|------------------------|-------------|
| ECONOMY | 11-1200 | 4.75" | \$3.95/ea |
| MID GRADE | 11-1200-S | 4.75", Satin Finish | \$6.95/ea |
| GERMAN | 12-100 | 4.75" | \$24.00/ea |
| INTEGRA/MILTEX | MIL8-4 | 4 3/4", w/Scissors | \$92.09/ea |
| | MIL8-4TC | 4.75" Tungsten Carbide | \$142.51/ea |

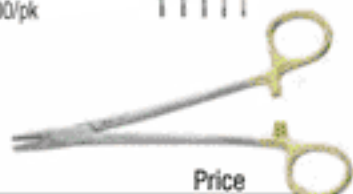

Halsey Needle Holder

| Vendor | Item# | Details | Price |
|-----------------------|----------|----------------------|-------------|
| GERMAN | 12-152 | 5" Smooth Jaw | \$59.00/ea |
| | 12-153 | 5", Tungsten Carbide | \$59.00/ea |
| INTEGRA/MILTEX | MIL8-8TC | 5", Tungsten Carbide | \$142.51/ea |



Masson Needle Holder

| Vendor | Item# | Details | Price |
|------------------|--------|---------|------------|
| JORGENSEN | JOR78M | 12" | \$48.00/ea |



Mathieu Needle Holder

| Vendor | Item# | Details | Price |
|------------------|----------|--|-------------|
| JORGENSEN | JOR80 | Economy, 7"6" (15cm) | \$14.00/ea |
| | JOR80WT | German, Tungsten Carbide Jaws, 6 1/2"6" (15cm) | \$90.00/ea |
| | JOR80WTH | Tungsten carbide jaws 6 1/2" | \$152.00/ea |
| GERMAN | 12-119 | 5.5" | \$40.00/ea |
| | 12-120 | 6.5" | \$40.00/ea |



Instruments

Needle Holders



Mayo Hegar Needle Holder



| Vendor | Item# | Details | Price |
|-----------------------|-----------|-----------------------------------|-------------|
| ECONOMY | 11-1205 | 5" | \$3.95/ea |
| | 11-1215 | 6" | \$3.95/ea |
| | 11-1220 | 7" | \$4.95/ea |
| | 11-1225 | 8" | \$4.95/ea |
| MID GRADE | 11-1205-S | 5", Satin Finish | \$6.95/ea |
| | 11-1215-S | 6" Satin Finish ¹² | \$6.95/ea |
| | 11-1225-S | 8", Satin Finish ¹² | \$7.95/ea |
| GERMAN | 12-106 | 5.5" | \$24.00/ea |
| | 12-107 | 6" | \$24.00/ea |
| | 12-108 | 7" | \$24.00/ea |
| | 12-110 | 8" | \$24.00/ea |
| | 12-161 | 5.5" Tungsten Carbide | \$55.00/ea |
| | 12-162 | 6" Tungsten Carbide | \$55.00/ea |
| | 12-163 | 7" Tungsten Carbide | \$55.00/ea |
| INTEGRA/MILTEX | MIL8-42 | 5" | \$84.04/ea |
| | MIL8-44 | 6" | \$83.35/ea |
| | MIL8-46 | 7" | \$91.80/ea |
| | MIL8-44TC | 6" Tungsten Carbide | \$144.58/ea |
| | MIL8-46TC | 7" Tungsten Carbide | \$157.76/ea |
| JORGENSEN | JOR78A | Economy, Stainless steel, 6" | \$8.00/ea |
| | JOR78B | Economy, Stainless steel, 7" | \$10.00/ea |
| | JOR78WTA | German, Tungsten Carbide Jaws, 6" | \$96.00/ea |
| | JOR78WTB | German, Tungsten Carbide Jaws, 7" | \$84.00/ea |

Olsen Hegar Needle Holder (with Scissors)



| Vendor | Item# | Details | Price | |
|------------------|---|---|-----------------------------------|-------------|
| ECONOMY | 11-1230 | 5.5", w/Scissors | \$5.95/ea | |
| | 11-1231 | 7.5, w/Scissors | \$5.95/ea | |
| | 11-1235 | 6.5", w/Scissors | \$5.95/ea | |
| | OHTC4.5 | 4.5" Tungsten Carbide, w/Scissors | \$26.95/ea | |
| | OHTC5.5 | 5.5" Tungsten Carbide, w/Scissors | \$26.95/ea | |
| | OHTC6.5 | 6.5" Tungsten Carbide, w/Scissors | \$27.95/ea | |
| | OHTC7.5 | 7.5" Tungsten Carbide, w/Scissors | \$29.95/ea | |
| MIDGRADE | 11-1230-S | 5.5", Satin Finish, w/Scissors | \$7.95/ea | |
| | 11-1231-S | 7.5", Satin Finish, w/Scissors | \$7.95/ea | |
| | 11-1235-S | 6.5", Satin Finish, w/Scissors | \$7.95/ea | |
| JORGENSEN | JOR79A | Economy, 6", w/Scissors | \$10.00/ea | |
| | JOR79B | Economy, 7", w/Scissors | \$10.80/ea | |
| | JOR79WTA | Tungsten Carbide Jaws, 5 1/2", w/Scissors | \$96.00/ea | |
| | JOR79WTB | Tungsten Carbide Jaws, 6 1/2", w/Scissors | \$99.00/ea | |
| JOR79WTD | Tungsten Carbide Jaws, 7 1/2", w/Scissors | \$102.00/ea | | |
| GERMAN | 12-116 | 5.5", w/Scissors | \$35.00/ea | |
| | 12-117 | 6.5", w/Scissors | \$35.00/ea | |
| | 12-118 | 7.25", w/Scissors | \$35.00/ea | |
| | 12-195 | 5", Tungsten Carbide, w/Scissors | \$60.00/ea | |
| | 12-196 | 5.5", Tungsten Carbide, w/Scissors | \$60.00/ea | |
| | 12-197 | 6.75", Tungsten Carbide, w/Scissors | \$60.00/ea | |
| | 12-198 | 7.5" Tungsten Carbide, w/Scissors | \$60.00/ea | |
| | INTEGRA/MILTEX | MIL8-14 | 4 3/4", w/Scissors | \$134.18/ea |
| | | MIL8-15 | 5.5", w/Scissors | \$110.25/ea |
| | | MIL8-15TC | 5.5" Tungsten Carbide, w/Scissors | \$181.11/ea |
| MIL8-16 | | 6.5", w/Scissors | \$116.15/ea | |
| MIL8-16TC | | 6.5" Tungsten Carbide, w/Scissors | \$186.87/ea | |
| MIL8-17 | | 7.5", w/Scissors | \$135.56/ea | |
| MIL8-17TC | | 7.5" Tungsten Carbide, w/Scissors | \$187.24/ea | |

SEE OUR DENTAL & LARGE ANIMAL SECTION FOR MORE INSTRUMENTS!

Webster Needle Holder

| Vendor | Item# | Details | Price |
|------------------|-----------|-------------------|-----------|
| ECONOMY | 11-1250 | 5" | \$2.95/ea |
| | 11-1251 | 6" | \$2.95/ea |
| MID GRADE | 11-1250-S | 5", Satin Finish | \$5.95/ea |
| | 11-1251-S | Economy, 6" Satin | \$5.95/ea |



| Vendor | Item# | Details | Price |
|-----------------------|--------|---------------------------------|------------|
| GERMAN | 12-102 | 4.75" | \$24.00/ea |
| | 12-151 | 5" Smooth Jaw, Tungsten Carbide | \$59.00/ea |
| INTEGRA/MILTEX | MIL8-6 | 5" Smooth | \$92.09/ea |



13822 WEST BOULTON BLVD. METTAWA, IL 60045

Phone 800-544-7521

WWW.SHOPMEDVET.COM

Fax 800-204-2177

Forceps



Adson Dressing Forceps

| Vendor | Item# | Details | Price |
|-----------------------|----------|--|------------|
| ECONOMY | 7-905 | 4.75" | \$1.95/ea |
| MID GRADE | 7-905-S | 4.75", Satin Finish | \$4.95/ea |
| JORGENSEN | JOR92BX | 4 3/4" (12cm). | \$3.60/ea |
| | JOR92BXW | German, 4 3/4" (12cm). | \$12.60/ea |
| GERMAN | 15-120 | 4.75" | \$16.00/ea |
| INTEGRA/MILTEX | MIL6-118 | 4.75" | \$50.19/ea |
| | MIL6-123 | For Suture, 1 X 2 teeth, 4-3/4" (12.1 cm), with lying platform | \$65.46/ea |

Micro Adson Dressing Forceps

| Vendor | Item# | Details | Price |
|-----------------------|------------|--|------------|
| INTEGRA/MILTEX | MIL17-2510 | 4-3/4" (12.1 cm), serrated jaws, 0.5 mm wide | \$70.73/ea |

Adson Tissue Forceps

| Vendor | Item# | Details | Price |
|-----------------------|----------|--|------------|
| ECONOMY | 8-950 | 4.5", 1x2 teeth | \$1.95/ea |
| MID GRADE | 8-950-S | 1X2 Teeth, 4.5", Satin Finish | \$4.95/ea |
| JORGENSEN | JOR92Q | Economy, 1 x 2 teeth, 4 3/4", Small delicate | \$3.60/ea |
| | JOR92QW | German, 1 x 2 teeth, 4 3/4", Small delicate (12cm) | \$13.50/ea |
| GERMAN | 15-124 | 4.75", 1x2 teeth | \$13.00/ea |
| | 15-129 | 4.75", 2x3 teeth | \$7.50/ea |
| INTEGRA/MILTEX | MIL6-120 | 4.75", 1x2 teeth | \$53.35/ea |
| | MIL6-121 | 4.75", 1x2 teeth W/Serrated Tips | \$56.59/ea |

Brown Forceps

| Vendor | Item# | Details | Price |
|-----------------------|----------|--------------------------------|------------|
| ECONOMY | 8-955 | 4.75", 9x9 teeth | \$3.95/ea |
| MID GRADE | 8-955-S | 9X9 Teeth, 4.75", Satin Finish | \$6.95/ea |
| GERMAN | 15-125 | 4.75", 9x9 teeth | \$24.00/ea |
| INTEGRA/MILTEX | MIL6-124 | 4.75", 7x7 teeth | \$72.55/ea |

Allis Tissue Forceps

| Vendor | Item# | Details | Price |
|-----------------------|-----------|-----------------------------|------------|
| ECONOMY | 10-1000 | 6", 4x5 Teeth | \$3.10/ea |
| MID GRADE | 10-1000-S | 4X5 Teeth, 6", Satin Finish | \$5.99/ea |
| GERMAN | 17-104 | 6", 3x4 Teeth | \$20.00/ea |
| | 17-106 | 6", 4x5 Teeth | \$20.00/ea |
| | 17-108 | 6", 5x6 Teeth | \$20.00/ea |
| | 17-110 | 7", 5x6 Teeth | \$20.00/ea |
| INTEGRA/MILTEX | MIL16-6 | 6", 4x5 teeth | \$84.06/ea |
| | MIL16-8 | 6", 5x6 Teeth | \$84.06/ea |
| JORGENSEN | JOR80AW | German, 6" | \$27.00/ea |
| | JOR80A | Economy, 6"6" | \$8.00/ea |
| | JOR80B | 7" | \$8.00/ea |

Alligator Forceps

| Vendor | Item# | Details | Price |
|------------------|---------|--------------|------------|
| JORGENSEN | JOR93A | 3 1/2" Shaft | \$27.00/ea |
| | JOR93B | 5 1/2" Shaft | \$36.00/ea |
| | JOR93C | 8" Shaft | \$51.00/ea |
| | JOR93D | 12" Shaft | \$57.00/ea |
| | JOR93BW | 5 1/2" Shaft | \$69.00/ea |

Extraction Alligator Forceps

| Vendor | Item# | Details | Price |
|------------------|--------|-----------|----------|
| JORGENSEN | JOR93E | 21" Shaft | \$140.00 |

Hartman Alligator Forceps

| Vendor | Item# | Details | Price |
|----------------|---------|---------|------------|
| ECONOMY | 10-1105 | 3.5" | \$24.00/ea |
| | 10-1110 | 5.5" | \$24.00/ea |
| GERMAN | 21-147 | 5.5" | \$60.00/ea |

Babcock Forceps

| Vendor | Item# | Details | Price |
|----------------|-------|---------|------------|
| ECONOMY | 7-160 | 7.5" | \$11.00/ea |

Baby Mixer Forceps



| Vendor | Item# | Details | Price |
|-----------------------|----------|--|------------|
| INTEGRA/MILTEX | MIL7-210 | 5-1/4" (13.3 cm), fully curved, extra delicate | \$89.80/ea |

Bishop-Harmon Forceps



| Vendor | Item# | Details | Price |
|---------------|--------|---------|------------|
| GERMAN | 13-111 | 3.5 | \$30.00/ea |

Beasley Babcock forceps

| Vendor | Item# | Price |
|------------------|--------|---------|
| JORGENSEN | JOR92W | \$15.00 |

Instruments

Forceps

Bennett Cilia Forceps

| Vendor | Item# | Details | Price |
|-----------------------|------------|------------------------------|-------------|
| INTEGRA/MILTEX | MIL18-1112 | 3" CUT SHAPED JAWS, 3MM DIA. | \$145.77/ea |

Bozeman Hemostat Forceps

| Vendor | Item# | Details | Price |
|---------------|--------|--------------|------------|
| GERMAN | 12-233 | 10.5" Curved | \$29.00/ea |

Bovine Forceps

| Vendor | Item# | Details | Price |
|------------------|--------|----------------------|------------|
| JORGENSEN | JOR15C | Stainless Steel, 12" | \$45.00/ea |

Brown Adson Forcep

| Vendor | Item# | Details | Price |
|---------------|---------|---------------------|------------|
| GERMAN | JOR92BA | 4 1/2", 7 x 8 teeth | \$31.50/ea |

Castroviejo Fixation Forceps

| Vendor | Item# | Details | Price |
|------------------|---------|--|---------|
| JORGENSEN | JOR232E | Economy, 1 x 1 teeth, 3 1/2" | \$24.00 |
| | JOR232 | For suturing the cornea. 1 x 1 delicate teeth. German-made. 3 1/2" | \$89.00 |

Crile Forceps

| Vendor | Item# | Details | Price |
|------------------|-----------------------|-----------------------------|---------------|
| ECONOMY | 4-530 | 5.5" Straight | \$2.95/ea |
| | 4-531 | 5.5" Curved | \$2.95/ea |
| | 4-532 | 6.25" Straight | \$2.95/ea |
| | 4-533 | 6.25" Curved | \$2.95/ea |
| MID GRADE | 4-530-S | 5.5" Straight, Satin Finish | \$5.95/ea |
| | 4-531-S | 5.5" Curved, Satin Finish | \$5.95/ea |
| | 4-532-S | 6.25" Straight Satin Finish | \$5.95/ea |
| | 4-533-S | 6.25" Curved, Satin Finish | \$5.95/ea |
| JORGENSEN | JOR72C | Economy, Curved, 6" | \$6.20 |
| | JOR72S | Economy, Straight, 6" | \$6.00 |
| | JOR72CW | German, Curved, 6" | \$25.00 |
| | JOR72SW | German, Straight, 6" | \$24.00 |
| GERMAN | 07-113 | 5.5" Straight | \$16.00/ea |
| | 07-114 | 5.5" Curved | \$16.00/ea |
| | 07-115 | 6.25" Straight | \$16.00/ea |
| | 07-116 | 6.25" Curved | \$16.00/ea |
| | INTEGRA/MILTEX | MIL7-42 | 5.5" Straight |
| MIL7-44 | | 5.5" Curved | \$52.83/ea |

Crile-Rankin Forceps

| Vendor | Item# | Details | Price |
|---------------|--------|----------------|------------|
| GERMAN | 13-183 | 6.25" Straight | \$18.00/ea |
| | 13-184 | 6.25" Curved | \$18.00/ea |

Carmalt Forceps

| Vendor | Item# | Details | Price |
|------------------|---------|---------------------------|---------|
| JORGENSEN | JOR83C | Economy, Curved 6 1/4" | \$10.00 |
| | JOR83S | Economy, Straight, 6 1/4" | \$10.00 |
| | JOR83CW | German, Curved, 6 1/4" | \$31.00 |
| | JOR83SW | German, Straight, 6 1/4" | \$31.00 |

Debakey Y Vascular Tissue Forceps

| Vendor | Item# | Details | Price |
|-----------------------|-----------|--------------------------------|-------------|
| JORGENSEN | JOR92DV | 1.5mm tips, 6" (15cm). | \$43.00/ea |
| INTEGRA/MILTEX | MIL24-572 | 8" (20.3 cm), 1.5 mm wide jaws | \$137.17/ea |

DEBAKEY Thoracic Tissue Forceps

| Vendor | Item# | Details | Price |
|-----------------------|-----------|-------------------------------------|-------------|
| INTEGRA/MILTEX | MIL24-552 | 7 1/2", (19.7 cm), 2.5 mm wide jaws | \$130.10/ea |

Desmarres-Chalazion Forceps

| Vendor | Item# | Details | Price |
|---------------|--------|---------|------------|
| GERMAN | 20-145 | 16mm | \$80.00/ea |
| | 20-147 | 20mm | \$80.00/ea |
| | 20-149 | 26mm | \$80.00/ea |

Doyen Forceps

| Vendor | Item# | Details | Price |
|------------------|-----------|---|-------------|
| ECONOMY | 7-131 | 9" Straight | \$9.29/ea |
| | 7-132 | 9" Curved | \$9.29/ea |
| GERMAN | 17-130 | 9" Straight | \$32.00/ea |
| | 17-132 | 9" Curved | \$32.00/ea |
| JORGENSEN | JOR135C | Excellent for ear cropping, Curved, 4" jaws. Stainless steel, 9". | \$19.50/ea |
| | JOR135S | Straight | \$19.50/ea |
| MILTEX | MIL16-160 | 9" Straight | \$227.60/ea |

Instruments

Forceps

Esophageal Foreign Body Forceps

Jorvet

| Vendor | Item# | Details | Price |
|------------------|-----------|---|-------------|
| JORGENSEN | JOR212EFB | 25cm shaft x 3.0mm diameter | \$160.00/ea |
| | JOR212EFA | 50cm shaft x 4.2mm diameter | \$180.00/ea |
| | JOR212EF | 50cm shaft x 7.5mm/6mm diameter. Extra long forceps (83cm or 29" long shafts). Diameter jaws 13mm x 9mm. Maximum jaw gap is 30mm. | \$165.00/ea |



Extracting Forceps



| Vendor | Item# | Details | Price |
|---------------|--------|--------------------------------|------------|
| GERMAN | V-307A | 7", Universal Forceps | \$48.00/ea |
| | V-307B | 7", Splitter/Separator Forceps | \$48.00/ea |
| | V-307C | 7", Incisor/Bicuspid Forceps | \$48.00/ea |
| | V-307D | 7", Molar/Extractor Forceps | \$48.00/ea |

Eye Dressing Forceps



| Vendor | Item# | Details | Price |
|-----------------------|-----------|------------------------------------|------------|
| ECONOMY | 10-1025 | 4" Straight | \$2.95/ea |
| | 10-1030 | 4" 1/2 Curved | \$2.95/ea |
| | 10-1035 | 4" Full curved | \$2.95/ea |
| MID GRADE | 10-1025-S | 4", Straight Satin Finish | \$5.95/ea |
| | 10-1030-S | 4", 1/2 Curved Satin Finish | \$5.95/ea |
| | 10-1035-S | 4", Curved, Satin Finish | \$5.95/ea |
| GERMAN | 15-145 | 4" Straight, Serrated | \$14.00/ea |
| | 15-146 | 4.5" Curved, Half Curved, Serrated | \$14.00/ea |
| | 15-147 | 4" Curved, Full Curved, Serrated | \$14.00/ea |
| INTEGRA/MILTEX | MIL18-780 | 4" Straight | \$47.98/ea |
| | MIL18-782 | 4" 1/2 Curved | \$49.51/ea |
| | MIL18-784 | 4" Full Curved | \$49.36/ea |

Ferguson Angiotribe Forceps

| Vendor | Item# | Details | Price |
|------------------|---------|-----------------------------------|-------------|
| GERMAN | 07-156 | 6.25" Straight | \$48.00/ea |
| | 07-157 | 6.25" Curved | \$48.00/ea |
| | 07-158 | 7.5" Straight | \$48.00/ea |
| | 07-159 | 7.5" Curved | \$48.00/ea |
| JORGENSEN | JOR73C | Curved, Economy, 7" | \$10.00/ea |
| | JOR73CW | Curved, German, 6 1/2" (16.5cm) | \$117.50/ea |
| | JOR73S | Economy, Straight, 7" | \$10.00/ea |
| | JOR73SW | German, Straight, 6 1/2" (16.5cm) | \$84.00/ea |



Feilchenfeld Splinter Forceps



| Vendor | Item# | Details | Price |
|------------------|----------|------------------|------------|
| MID GRADE | 16-105-S | 3", Satin Finish | \$12.00/ea |
| GERMAN | 16-105 | 3" | \$9.00/ea |

Feline Declaw Forceps



| Vendor | Item# | Details | Price |
|------------------|----------|---------------------------------|------------|
| JORGENSEN | JOR1026 | Stainless Steel, German, 4" | \$36.00/ea |
| | JOR1026A | Stainless Steel, German, 5 1/4" | \$36.00/ea |

Forester Sponge Forceps



| Vendor | Item# | Details | Price |
|-----------------------|----------|---|------------|
| ECONOMY | 6-840 | 9.5" | \$6.95/ea |
| MID GRADE | 6-840-S | 9.5", Satin Finish | \$9.95/ea |
| GERMAN | 09-106 | 9.5" | \$32.00/ea |
| INTEGRA/MILTEX | MIL7-600 | 9-1/2" (24.1 cm), straight, serrated jaws | \$87.66/ea |

Graefe Iris Forceps



| Vendor | Item# | Details | Price |
|------------------|----------|----------------------|-----------|
| JORGENSEN | JOR231GC | Serrated, Curved, 4" | \$9.00/ea |
| | JOR231GS | Straight 4" | \$9.00/ea |



Halsted Mosquito Forceps



| Vendor | Item# | Details | Price |
|-----------------------|---------|------------------------|------------|
| INTEGRA/MILTEX | MIL7-10 | Curved, Extra Delicate | \$76.15/ea |

Iris Forceps



| Vendor | Item# | Details | Price |
|------------------|-----------|---|-----------|
| MID GRADE | 10-1040-S | 1X2 Teeth, 4", Straight Satin Finish | \$5.95/ea |
| | 10-1045-S | 1X2 Teeth, 4 1/2", Curved, Satin Finish | \$5.95/ea |

Jones Artery Forcep



| Vendor | Item# | Details | Price |
|------------------|-------|---------|-----------|
| JORGENSEN | JOR95 | 5" | \$4.95/ea |

Jorvet

Instruments

Forceps



Jewelers Forceps

| Vendor | Item# | Details | Price |
|-----------------------|-----------|---------|------------|
| GERMAN | 10-557 | #5 | \$15.00/ea |
| | 10-558 | #6 | \$15.00/ea |
| | 10-559 | #7 | \$15.00/ea |
| INTEGRA/MILTEX | MIL17-306 | #6 | \$46.42/ea |



Kantrowitz Thoracic Forceps

| Vendor | Item# | Details | Price |
|-----------------------|-------------|---|------------|
| INTEGRA/MILTEX | MILMH25-836 | 7 1/2" (19.1 cm), delicate right angle jaws | \$99.67/dz |

Kelly Forceps



| Vendor | Item# | Details | Price |
|-----------------------|---------|------------------------------|------------|
| ECONOMY | 4-520 | 5.5" Straight | \$2.95/ea |
| | 4-521 | 5.5" Curved | \$2.95/ea |
| | 4-522 | 6.25" Straight | \$2.95/ea |
| | 4-523 | 6.25" Curved | \$2.95/ea |
| | 4-560 | 8.5" Straight | \$2.95/ea |
| MID GRADE | 4-520-S | 5.5", Straight, Satin Finish | \$5.95/ea |
| | 4-521-S | 5.5", Curved, Satin Finish | \$5.95/ea |
| JORGENSEN | JOR71C | Curved, 5 1/2" | \$5.30/ea |
| | JOR71CW | German, Curved, 5 1/2" | \$24.00/ea |
| | JOR71SW | German, Straight, 5 1/2" | \$24.00/ea |
| | JOR71S | Straight, 5 1/2" | \$5.30/ea |
| GERMAN | 07-109 | 5.5" Straight | \$16.00/ea |
| | 07-110 | 5.5" Curved | \$16.00/ea |
| | 07-111 | 6.25" Straight | \$16.00/ea |
| | 07-112 | 6.25" Curved | \$16.00/ea |
| INTEGRA/MILTEX | MIL7-36 | 5.5" Straight | \$56.30/ea |
| | MIL7-38 | 5.5" Curved | \$58.93/ea |

Kelly-Rankin Forceps



| Vendor | Item# | Details | Price |
|---------------|--------|--------------|------------|
| GERMAN | 07-108 | 6.25" Curved | \$18.00/ea |

Littauer Forceps

| Vendor | Item# | Details | Price |
|-----------------------|------------|---------|------------|
| GERMAN | 21-223 | 3.5" | \$12.00/ea |
| INTEGRA/MILTEX | MIL18-1100 | 3.5" | \$31.90/ea |



Lucae Forceps

| Vendor | Item# | Details | Price |
|------------------|--------|----------------|------------|
| JORGENSEN | JOR92X | 5 3/4" (14cm). | \$12.75/ea |



McLean OB Forceps **JorVet**

| Vendor | Item# | Details | Price |
|------------------|--------|---------|------------|
| JORGENSEN | JOR22H | 8" L. | \$33.00/ea |

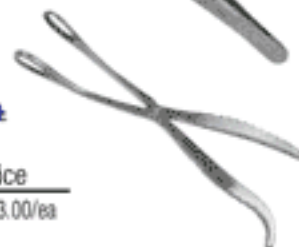

Michel Forceps

Can be used both for applying and removing Michel clips. Stainless steel. 12cm. 100 clips/rack.

| Vendor | Item# | Details | Price |
|------------------|---------|------------------|-----------|
| MID GRADE | 5-960-S | 5", Satin Finish | \$9.95/ea |



Magill Forceps

| Vendor | Item# | Details | Price |
|------------------|---------|---------|------------|
| JORGENSEN | JOR631C | Large | \$15.00/ea |
| | JOR631B | Medium | \$15.00/ea |
| | JOR631A | Small | \$15.00/ea |



Lesser Suture Retrieval Forceps

| Vendor | Item# | Price |
|------------------|---------|-------------|
| JORGENSEN | JOR1066 | \$123.00/ea |

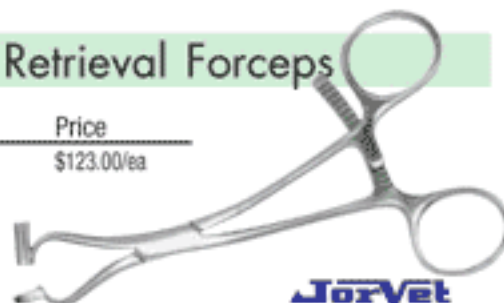

Forceps

Mosquito Forceps

| Vendor | Item# | Details | Price |
|-----------------------|---------|-------------------------------|------------|
| ECONOMY | 4-500 | 3.5" Straight | \$2.95/ea |
| | 4-501 | 3.5" Curved | \$2.95/ea |
| | 4-510 | 5-5.5" Straight | \$2.95/ea |
| | 4-511 | 5-5.5" Curved | \$2.95/ea |
| GERMAN | 07-100 | 3.5" Straight | \$15.00/ea |
| | 07-101 | 3.5" Curved | \$15.00/ea |
| | 07-102 | 5" Straight | \$16.00/ea |
| | 07-104 | 5" Curved | \$15.00/ea |
| MID GRADE | 4-500-S | 3.5" Straight, Satin Finish | \$5.95/ea |
| | 4-501-S | 3.5" Curved Satin Finish | \$5.95/ea |
| | 4-510-S | 5-5.5" Straight, Satin Finish | \$5.95/ea |
| | 4-511-S | 5-5.5" Curved Satin Finish | \$5.95/ea |
| JORGENSEN | JOR70C | Economy, Curved, 5" | \$5.30/ea |
| | JOR70S | Economy, Straight, 5" | \$5.30/ea |
| | JOR70CW | German, Curved, 5" | \$27.00/ea |
| | JOR70SW | German, Straight, 5" | \$27.00/ea |
| INTEGRA/MILTEX | MIL7-2 | 5" Straight | \$55.74/ea |
| | MIL7-24 | 3.5" Straight | \$65.03/ea |
| | MIL7-26 | 3.5" Curved | \$67.13/ea |
| | MIL7-4 | 5" Curved | \$57.30/ea |
| | MIL7-8 | 5" Straight Delicate | \$74.47/ea |

Jorvet Nylon Forceps

NOTE: Not intended for everyday surgical use. These instruments are useful for a variety of clinical uses at a very affordable price. These instruments will come in handy for a lot of non surgical procedures.

- Autoclavable
- Will not rust
- Very inexpensive
- Non-repairable

Jorvet

Nylon Hemostat Forceps

| Vendor | Item# | Details | Price |
|------------------|---------|---------|-----------|
| JORGENSEN | JOR579H | 5" | \$2.25/ea |

Nylon Sponge Forceps

| Vendor | Item# | Details | Price |
|------------------|---------|---------|-----------|
| JORGENSEN | JOR579S | 8" | \$3.00/ea |

Nylon Thumb Forceps

| Vendor | Item# | Details | Price |
|------------------|---------|---------|-----------|
| JORGENSEN | JOR579T | 4 1/2" | \$3.30/ea |

Nylon Towel Clamp

| Vendor | Item# | Details | Price |
|------------------|---------|---------|-----------|
| JORGENSEN | JOR579C | | \$3.30/ea |



Jorvet Pig OB Forcep

Danish model. These forceps open sideways, making it practically impossible to catch the uterine lining. The piglet is gently grasped either around the head or the hips. No need of inserting your hand to place the instrument.

| Vendor | Item# | Details | Price |
|------------------|-------|---------|------------|
| JORGENSEN | JOR22 | 23" L | \$24.00/ea |

Jorvet Puppy OB Forceps

Stainless steel. Same design as JOR22.

| Vendor | Item# | Details | Price |
|------------------|--------|-----------------------|------------|
| JORGENSEN | JOR22A | Stainless Steel, 8" L | \$13.50/ea |

Pierse Colibri Type Corneal Forceps

| Vendor | Item# | Details | Price |
|-----------------------|-----------|---------------------|-------------|
| INTEGRA/MILTEX | MIL18-880 | 3-1/4", TIPS 0.12mm | \$292.91/ea |

Rochester Forceps

| Vendor | Item# | Details | Price |
|---------------|--------|--------------|------------|
| GERMAN | 07-122 | 7.25" Curved | \$29.00/ea |

Rochester-Carmalt Forceps

| Vendor | Item# | Details | Price |
|-----------------------|----------|---|-------------|
| ECONOMY | 4-540 | 6.25" Straight | \$4.95/ea |
| | 4-541 | 6.25" Curved | \$4.95/ea |
| | 4-542 | 8" Straight | \$5.95/ea |
| | 4-543 | 8" Curved | \$5.95/ea |
| MID GRADE | 4-540-S | 6.25" Straight, Satin Finish ⁶ | \$7.95/ea |
| | 4-541-S | 6.25" Curved, Satin Finish ⁶ | \$7.95/ea |
| | 4-542-S | 8" Straight, Satin Finish ⁶ | \$8.95/ea |
| | 4-543-S | 8" Curved, Satin Finish ⁶ | \$8.95/ea |
| GERMAN | 07-137 | 6.25" Straight | \$29.00/ea |
| | 07-138 | 6.25" Curved | \$29.00/ea |
| | 07-139 | 8" Straight | \$29.00/ea |
| | 07-140 | 8" Curved | \$29.00/ea |
| INTEGRA/MILTEX | MIL7-170 | 6.25" Straight | \$88.94/ea |
| | MIL7-172 | 6.25" Curved | \$92.85/ea |
| | MIL7-180 | 8" Straight | \$104.41/ea |
| | MIL7-182 | 8" Curved | \$109.76/ea |

Instruments

Forceps

Rochester-Ochsner Forceps



| Vendor | Item# | Details | Price |
|------------------|-----------------------|---|-------------|
| ECONOMY | 4-482 | 7.25" Straight | \$3.95/ea |
| | 4-580 | 6.25" Straight | \$3.95/ea |
| | 4-584 | 8" Straight | \$3.95/ea |
| | 4-586 | 6.25" Curved | \$3.95/ea |
| | 4-588 | 7.25" Curved | \$3.95/ea |
| | 4-590 | 8" Curved | \$3.95/ea |
| JORGENSEN | JOR72R0 | Curved, Economy, 1 x 2 teeth at tip. 6 1/4" (16cm). | \$7.50/ea |
| | JOR72R0W | Curved, German, 1 x 2 teeth at tip. 6 1/4" (16cm). | \$25.50/ea |
| | JOR72RS | Straight, Economy, 1 x 2 teeth at tip. 6 1/4" (16cm). | \$7.50/ea |
| | JOR72RSW | Straight, German, 1 x 2 teeth at tip. 6 1/4" (16cm). | \$24.00/ea |
| MID GRADE | 4-580-S | 6.25", Straight Satin Finish | \$6.95/ea |
| | 4-586-S | 6.25", Curved Satin Finish | \$6.95/ea |
| GERMAN | 07-141 | 5.5" Curved | \$18.00/ea |
| | 07-142 | 6.25" Curved | \$18.00/ea |
| | 07-143 | 7.25" Curved | \$18.00/ea |
| | 07-144 | 6.25" Straight | \$18.00/ea |
| | 07-145 | 7.25" Straight | \$18.00/ea |
| | 07-146 | 8" Curved | \$25.00/ea |
| | 07-147 | 5.5", Straight | \$18.00/ea |
| | 07-149 | 8" Straight | \$18.00/ea |
| | 07-150 | 10", Curved | \$39.00/ea |
| | INTEGRA/MILTEX | MIL7-154 | 8" Straight |

Rochester-Pean Forceps



| Vendor | Item# | Details | Price |
|----------------|----------|----------------|------------|
| ECONOMY | 4-552 | 7.5" Curved | \$3.95/ea |
| | 4-554 | 7-8" Straight | \$4.95/ea |
| GERMAN | 07-119 | 6.25" Straight | \$29.00/ea |
| | 07-120 | 6.25" Curved | \$29.00/ea |
| | 07-123 | 8" Straight | \$29.00/ea |
| | 07-124 | 8" Curved | \$29.00/ea |
| | 07-125 | 9" Curved | \$14.50/ea |
| MILTEX | MIL7-138 | 6.25" Curved | \$72.38/ea |

Sponge Forceps

| Vendor | Item# | Details | Price |
|------------------|-------|---------|-----------|
| JORGENSEN | JOR85 | 9 1/2" | \$6.90/ea |



Skin Staple Removing Forceps

| Vendor | Item# | Details | Price |
|-----------------------|---------|----------------|-------------|
| INTEGRA/MILTEX | MIL9-62 | 5 1/2" (14 cm) | \$164.75/dz |

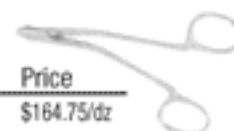

Splinter Forceps



| Vendor | Item# | Details | Price |
|-----------------------|----------|--------------------|------------|
| ECONOMY | 8-900 | 4.5" | \$2.95/ea |
| MID GRADE | 8-900-S | 4.5", Satin Finish | \$5.95/ea |
| GERMAN | 16-112 | 4.5" | \$9.00/ea |
| | 16-115 | 5.5" | \$18.00/ea |
| INTEGRA/MILTEX | MIL6-304 | 4.5" | \$24.63/ea |

Sterilizer Forceps



| Vendor | Item# | Details | Price |
|----------------|---------|---------|------------|
| ECONOMY | 11-1185 | 8" | \$7.95/ea |
| GERMAN | 10-104 | 8" | \$24.00/ea |

Swiss Tweezer Forceps

| Vendor | Item# | Details | Price |
|---------------|--------|---------|-----------|
| GERMAN | 36-109 | #1 | \$9.00/ea |
| | 36-110 | #2 | \$9.00/ea |
| | 36-111 | #4 | \$9.00/ea |
| | 36-112 | #5 | \$9.00/ea |
| | 36-113 | #6 | \$9.00/ea |
| | 36-114 | #7 | \$9.00/ea |



Tissue Forceps

| Vendor | Item# | Details | Price |
|-----------------------|---------|---|------------|
| INTEGRA/MILTEX | MIL6-46 | standard pattern serrated handles, 6" (15.2 cm) | \$30.24/ea |

Iris Tissue Forceps

| Vendor | Item# | Details | Price |
|------------------|-----------|--------------------------------------|------------|
| ECONOMY | 10-1040 | 4", 1x2 teeth Straight | \$2.95/ea |
| | 10-1045 | 4", 1x2 teeth 1/2 Curved | \$2.95/ea |
| | 10-1050 | 4", 1x2 teeth Curved | \$2.95/ea |
| MID GRADE | 10-1040-S | 1X2 Teeth, 4", Straight Satin Finish | \$5.95/ea |
| | 10-1050-S | 1X2 Teeth, 4" Curved Satin Finish | \$5.95/ea |
| GERMAN | 15-150 | 4", Straight, 1x2 Teeth, Serrated | \$14.00/ea |
| | 15-151 | 4", 1x2 teeth Curved | \$14.00/ea |

Russian Tissue Forcep

| Vendor | Item# | Details | Price |
|-----------------------|---------------|---------------------------|------------|
| ECONOMY | 8-960 | 6" | \$3.95/ea |
| | 8-965 | 8" | \$3.95/ea |
| JORGENSEN | JOR92R | | \$7.50/ea |
| MID GRADE | 8-960-S | 6", Economy, Satin Finish | \$6.95/ea |
| | GERMAN | 15-110 | 6" |
| INTEGRA/MILTEX | MIL6-142 | 6" | \$51.16/ea |



Instruments

Forceps & Clamps



Tissue Forceps

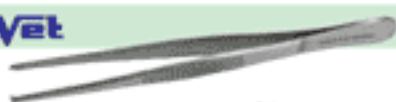

| Vendor | Item# | Details | Price |
|------------------|----------|------------------------------|------------|
| JORGENSEN | JOR92 | 5 1/2" | \$2.10/ea |
| | JOR92TB | 2 x 3 teeth Economy, 5 1/2" | \$3.60/ea |
| | JOR92TBW | 2 x 3 Teeth, German, 5 1/2" | \$9.90/ea |
| | JOR92TCW | 3 x 4 Teeth German, 5 1/2" | \$13.50/ea |
| | JOR92TC | 3 x 4 Teeth, Economy, 5 1/2" | \$4.20/ea |
| | JOR92TD | 4 x 5 Teeth Economy, 5 1/2" | \$4.50/ea |
| | JOR92TA | Economy, 1 x 2 teeth | \$2.70/ea |
| | JOR92TAW | German, 1 x 2 teeth | \$7.50/ea |



Thumb Tissue Forceps



| Vendor | Item# | Details | Price |
|-----------------------|---------|-----------------------------------|------------|
| ECONOMY | 8-920 | 5-5.5", 1x2 teeth | \$1.95/ea |
| | 8-925 | 6-6.5", 1x2 teeth | \$1.95/ea |
| MID GRADE | 8-920-S | 1 X 2 Teeth, 5-5.5", Satin Finish | \$4.95/ea |
| | 8-925-S | 1 X 2 Teeth, 6-6.5", Satin Finish | \$4.95/ea |
| GERMAN | 14-104 | 5.5", 1x2 teeth | \$12.00/ea |
| | 14-122 | 5.5", 2x3 teeth | \$12.00/ea |
| | 14-132 | 5.5", 3x4 teeth | \$12.00/ea |
| INTEGRA/MILTEX | MIL6-42 | 5", 1x2 teeth | \$24.84/ea |

Thumb Dressing Forceps



| Vendor | Item# | Details | Price |
|-----------------------|---------|--------------------|------------|
| ECONOMY | 7-855 | 4.5" | \$1.95/ea |
| | 7-865 | 5.5" | \$1.95/ea |
| | 7-880 | 8" | \$3.95/ea |
| MID GRADE | 7-855-S | 4.5", Satin Finish | \$4.95/ea |
| | 7-865-S | 5.5", Satin Finish | \$4.95/ea |
| | 7-880-S | 8", Satin Finish | \$4.95/ea |
| GERMAN | 13-106 | 5.5" Serrated | \$9.00/ea |
| INTEGRA/MILTEX | MIL6-6 | 5" | \$23.14/ea |
| | MIL6-8 | 5.5" | \$23.73/ea |

Young Tongue Seizing Forceps



| Vendor | Item# | Details | Price |
|------------------|--------|-----------------------------------|------------|
| GERMAN | 33-287 | 6.25" | \$39.00/ea |
| JORGENSEN | JOR895 | Stainless Steel, 6 3/4" (17cm) L. | \$16.50/ea |

Verbrugge Forceps



| Vendor | Item# | Details | Price |
|------------------|----------|---------|-------------|
| JORGENSEN | JOR213VA | 6.5" | \$192.00/ea |
| | JOR213VB | 9.5" | \$220.00/ea |

Backhaus Towel Clamps



| Vendor | Item# | Details | Price |
|-----------------------|----------|--------------------|------------|
| ECONOMY | 5-805 | 3.5" | \$3.95/ea |
| | 5-806 | 5.5" | \$3.95/ea |
| MID GRADE | 5-805-S | 3.5", Satin Finish | \$6.95/ea |
| | 5-806-S | 5.5", Satin Finish | \$6.95/ea |
| GERMAN | 11-100 | 3.5" | \$14.00/ea |
| | 11-101 | 5.5" | \$14.00/ea |
| INTEGRA/MILTEX | MIL7-504 | 3.5" | \$51.89/ea |
| | MIL7-506 | 5.25" | \$53.67/ea |

Baby Doyen Intestinal Clamp

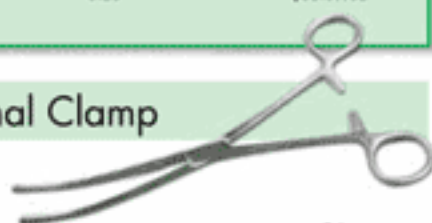

| Vendor | Item# | Details | Price |
|------------------|----------|---|-------------|
| JORGENSEN | JOR135CW | 18cm cvd, 6 1/2" flexible blade with diagonal serrations. | \$109.00/ea |
| | JOR135SW | 18cm cvd, 6 1/2" flexible blade with diagonal serrations. | \$106.00/ea |

Backhaus Towel Clamp



| Vendor | Item# | Details | Price |
|------------------|---------|--|------------|
| JORGENSEN | JOR81S | Economy with stops (Roeder), 5 1/2". | \$5.60/ea |
| | JOR81A | Economy, 3 1/2" | \$5.00/ea |
| | JOR81B | Economy, 5 1/2" | \$5.40/ea |
| | JOR81AW | German, 3 1/2" | \$20.80/ea |
| | JOR81BW | German, 5 1/2" | \$22.80/ea |
| | JOR81WS | German-Made with stops (Roeder), 5 1/2". | \$26.00/ea |

Condyle Clamp

An improvement over the old style rectangular plexi-glass condyle clamp. This triangular, stainless steel, two-sided clamp fits over the humeral condyles and allows greater alignment. A lag screw can be inserted through the hole in the middle of the triangular plate. Reduction may be checked by radiography prior to lag screw fixation. Pressure should be applied proximo-laterally not just purely laterally.



| Vendor | Item# | Price |
|------------------|---------|-------------|
| JORGENSEN | JOR213C | \$106.00/ea |

DeBakey Vascular Clamp

| Vendor | Item# | Details | Price |
|------------------|---------|--|-------------|
| JORGENSEN | JOR720V | Slightly Curved 7.5cm L jaw, Stainless steel, 23cm Stainless steel, 23cm | \$261.00/ea |

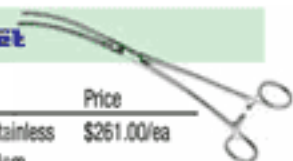

Clamps



Breed Specific Ear Trim Clamp

JorVet

| Vendor | Item# | Details | Price |
|------------------|----------|------------------------------------|------------|
| JORGENSEN | JOR49MCv | Doberman Pattern, 15 cm. 6" | \$39.00/ea |
| | JOR49MB | Boxer Pattern, 13.5cm. 5.4" | \$39.00/ea |
| | JOR49MD | Great Dane Pattern, 18.5cm. 7.4" | \$39.00/ea |
| | JOR49ME | Boston Terrier Pattern, 12cm. 4.8" | \$39.00/ea |

Ear Clamp

| Vendor | Item# | Details | Price |
|------------------|---------|------------------|------------|
| JORGENSEN | JOR49HC | Curved, 14 cm. | \$80.00/ea |
| | JOR49HB | Straight, 10 cm. | \$82.00/ea |
| | JOR49HD | Straight, 14 cm. | \$46.00/ea |

Hernia Clamp

| Vendor | Item# | Details | Price |
|------------------|--------|-----------------|------------|
| JORGENSEN | JOR56G | Aluminum. 14cm. | \$46.50/ea |

Huston Umbilical Clamp

| Vendor | Item# | Details | Price |
|------------------|---------|--------------------------|-----------|
| JORGENSEN | JOR56HA | Huston Hernia Clamp. 5". | \$8.25/ea |
| | JOR56HB | Huston Hernia Clamp. 7" | \$9.60/ea |

Jones Towel Clamp

| Vendor | Item# | Details | Price |
|------------------|---------|--------------------|------------|
| ECONOMY | 5-815 | 3.5" | \$2.95/ea |
| MID GRADE | 5-815-S | 3.5", Satin Finish | \$5.95/ea |
| GERMAN | 11-110 | 4.5" | \$14.00/ea |

Instrument Clamp Covers

JorVet

| Vendor | Item# | Details | Price |
|------------------|--------|--|------------|
| JORGENSEN | JOR928 | Packaged 12 per bag, four each of three sizes and colors: 2.5mm x 50mm (1/10" x 2"), 5mm x 50mm (2/10" x 2"), 7.5mm x 50mm (3/10" x 2"). | \$22.50/dz |

Ligament Meniscus Clamp

| Vendor | Item# | Price |
|------------------|---------|-------------|
| JORGENSEN | JOR236C | \$170.00/ea |

Lorna Towel Clamp

| Vendor | Item# | Details | Price |
|-----------------------|----------|--------------------|------------|
| ECONOMY | 5-820 | 3.5" | \$4.95/ea |
| | 5-821 | 5.5" | \$4.95/ea |
| MID GRADE | 5-820-S | 3.5", Satin Finish | \$7.95/ea |
| | 5-821-S | 5.5", Satin Finish | \$7.95/ea |
| GERMAN | 11-104 | 4" | \$24.00/ea |
| | 11-105 | 5.25" | \$24.00/ea |
| INTEGRA/MILTEX | MIL7-515 | 5.25" | \$91.88/ea |

Martin Cartilage Clamp

| Vendor | Item# | Details | Price |
|---------------|--------|---------|------------|
| GERMAN | 33-111 | 7" | \$60.00/ea |

Micro Tooth Meniscus Clamp

JorVet

Management of meniscal injuries is very important. In medium and small dogs space limits access. The toothed minimeniscus forceps are designed to grasp damaged meniscus tissue to facilitate removal using micro blades.

| Vendor | Item# | Details | Price |
|------------------|---------|--|------------|
| JORGENSEN | JOR236H | The toothed minimeniscus forceps are designed to grasp damaged meniscus tissue to facilitate removal using micro blades. | \$36.00/ea |

Vasectomy Ring Clamp (No Scalpel)

| Vendor | Item# | Details | Price |
|-----------------------|-----------|----------------------------------|-------------|
| INTEGRA/MILTEX | MIL29-805 | 5 1/2" (14cm), gold finger rings | \$152.69/ea |

DeBakey Vascular Clamp

JorVet

| Vendor | Item# | Details | Price |
|------------------|---------|--|-------------|
| JORGENSEN | JOR720V | Slightly Curved 7.5cm L jaw, Stainless steel, 23cm | \$261.00/ea |

X-Small Serrated Bone Clamp

JorVet

| Vendor | Item# | Details | Price |
|------------------|--------|---------|------------|
| JORGENSEN | JOR854 | 5" L | \$73.00/ea |

Instruments

Scissors

Aesculap Mayo Scissors



| Vendor | Item# | Details | Price |
|------------------|---------|---|-------------|
| JORGENSEN | JOR663C | Tungsten Carbide Inserts, Gold-plated Rings, Curved 6 3/4" | \$190.00/ea |
| | JOR663 | Tungsten Carbide Inserts, Gold-plated Rings, Straight, 6 3/4" | \$184.00/ea |

Aesculap Metzenbaum Scissors

Jorvet



| Vendor | Item# | Details | Price |
|------------------|----------|--|-------------|
| JORGENSEN | JOR662C | Tungsten Carbide Inserts, Gold-plated Rings, Curved 5 1/2" | \$185.00/ea |
| | JOR662DC | Tungsten Carbide Inserts, Gold-plated Rings, Curved 7" | \$205.00/ea |
| | JOR662D | Tungsten Carbide Inserts, Gold-plated Rings, Straight 7" | \$190.00/ea |
| | JOR662 | Tungsten Carbide Inserts, Gold-plated Rings, Straight 5 1/2" | \$190.00/ea |

Angle Serrated Wire Cutting Scissors



| Vendor | Item# | Details | Price |
|------------------|---------|------------------|-----------|
| ECONOMY | 4-380 | 5" | \$2.95/ea |
| MID GRADE | 4-380-S | 5", Satin Finish | \$5.95/ea |

Bandage Scissors



| Vendor | Item# | Details | Price |
|-----------------------|----------|----------------------|------------|
| INTEGRA/MILTEX | MIL5-700 | 5-1/2" (14 cm), Pink | \$36.07/ea |

Castroviejo Scissors



| Vendor | Item# | Details | Price |
|---------------|--------|---------|------------|
| GERMAN | 01-158 | 4.25" | \$90.00/ea |

Ear Cropping Scissors



| Vendor | Item# | Details | Price |
|---------------|--------|------------------|------------|
| GERMAN | 01-164 | 6.25" | \$38.00/ea |
| | 01-165 | 6.5" Sharp/Blunt | \$38.00/ea |
| | 01-166 | 6.5" Blunt/Blunt | \$38.00/ea |



Earcrop Cartilage Scissors

| Vendor | Item# | Details | Price |
|------------------|--------|--|------------|
| JORGENSEN | JOR49S | one serrated edge, Stainless steel, 6 1/2" | \$30.00/ea |

Martin Cartilage Scissors

| Vendor | Item# | Details | Price |
|-----------------------|------------|------------------|-------------|
| JORGENSEN | JOR49X | 8" 1/4" (10.8cm) | \$66.00/ea |
| GERMAN | 33-110 | 8" Straight | \$45.00/ea |
| | 33-112 | 8" Curved | \$45.00/ea |
| INTEGRA/MILTEX | MIL27-1000 | 8" Straight | \$137.70/ea |

German Surgical Scissors

| Vendor | Item# | Details | Price |
|------------------|---------|-------------------------------|------------|
| JORGENSEN | JOR75BW | Curved, Blunt/Blunt 5 1/2" | \$22.00/ea |
| | JOR75AW | Curved, Sharp/Blunt, 5 1/2" | \$22.00/ea |
| | JOR75FW | Curved, Sharp/Sharp, 5 1/2" | \$22.00/ea |
| | JOR75DW | Straight, Blunt/Blunt, 5 1/2" | \$22.00/ea |
| | JOR75EW | Straight, Sharp/Sharp, 5 1/2" | \$22.00/ea |

German Bandage Scissors

| Vendor | Item# | Details | Price |
|------------------|---------|---------|------------|
| JORGENSEN | JOR74WA | 5 1/2" | \$28.50/ea |
| | JOR74WB | 7 1/2" | \$32.30/ea |

Iris Ribbon Scissors

| Vendor | Item# | Details | Price |
|-----------------------|------------|--------------|------------|
| INTEGRA/MILTEX | MIL18-1418 | 3.75" Curved | \$92.49/ea |

Iris Scissors

| Vendor | Item# | Details | Price |
|-----------------------|-------------|--|-------------|
| ECONOMY | 4-330 | 4.5" Straight | \$2.95/ea |
| | 4-331 | 4.5" Curved | \$2.95/ea |
| MID GRADE | 4-330-S | 4.5" Straight, Satin Finish | \$5.95/ea |
| | 4-331-S | 4.5" Curved, Satin Finish | \$5.95/ea |
| JORGENSEN | JOR75WC | Curved, 4 1/2" | \$22.80/ea |
| | JOR75WS | Straight, 4 1/2" | \$22.80/ea |
| GERMAN | 01-144 | 3.5" Straight | \$15.00/ea |
| | 01-145 | 3.5" Curved | \$15.00/ea |
| | 01-148 | 4.5" Straight | \$15.00/ea |
| | 01-149 | 4.5" Curved | \$15.00/ea |
| | 01-150 | 4.5" Curved Tungsten Carbide | \$68.00/ea |
| | 01-151 | 4.5" Straight Tungsten Carbide | \$68.00/ea |
| INTEGRA/MILTEX | MIL5-302 | 3.5" Curved | \$67.71/ea |
| | MIL5-304 | 4.5" Straight | \$63.38/ea |
| | MIL5-304-TC | 4 1/2" (11.4 cm), Straight, Tungsten Carbide | \$165.39/ea |
| | MIL5-306 | 4.5" Curved | \$66.30/ea |

Instruments

Scissors

Knowles Bandage Scissors

| Vendor | Item# | Details | Price |
|-----------------------|----------|--------------------|------------|
| ECONOMY | 2-150 | 5.5" | \$3.95/ea |
| JORGENSEN | JOR74X | (5 1/2") | \$22.50/ea |
| MID GRADE | 2-150-S | 5.5", Satin Finish | \$6.95/ea |
| GERMAN | 02-106 | 5.5" | \$22.00/ea |
| INTEGRA/MILTEX | MIL5-560 | 5.5" | \$74.62/ea |

Lister Bandage Scissors

| Vendor | Item# | Details | Price |
|-----------------------|----------|--------------------|-------------|
| ECONOMY | 2-120 | 3.5" | \$2.95/ea |
| | 2-125 | 4.5" | \$2.95/ea |
| | 2-130 | 5.5" | \$2.95/ea |
| | 2-145 | 7.5" | \$3.95/ea |
| JORGENSEN | JOR74A | 5 1/2" | \$3.80/ea |
| | JOR74B | 7 1/2" | \$7.20/ea |
| MID GRADE | 2-120-S | 3.5", Satin Finish | \$5.95/ea |
| | 2-125-S | 4.5", Satin Finish | \$5.95/ea |
| | 2-130-S | 5.5", Satin Finish | \$5.95/ea |
| | 2-145-S | 7.5", Satin Finish | \$6.95/ea |
| GERMAN | 02-100 | 3.5" | \$18.00/ea |
| | 02-101 | 4.5" | \$18.00/ea |
| | 02-102 | 5.5" | \$18.00/ea |
| | 02-103 | 7.5" | \$18.00/ea |
| INTEGRA/MILTEX | MIL5-510 | 3.5" | \$50.63/ea |
| | MIL5-512 | 4.5" | \$52.58/ea |
| | MIL5-516 | 7.25" | \$81.70/ea |
| | MIL5-550 | 8" | \$110.60/ea |

Littauer Stitch Scissors

| Vendor | Item# | Details | Price |
|-----------------------|----------|-----------------------------|------------|
| ECONOMY | 4-370 | 4.5" | \$2.95/ea |
| | 4-371 | 5.5" | \$2.95/ea |
| MID GRADE | 4-370-S | 4.5", Straight Satin Finish | \$5.95/ea |
| JORGENSEN | JOR76 | Economy, 5 1/2" | \$4.80/ea |
| GERMAN | 02-113 | 4.5" | \$18.00/ea |
| | 02-114 | 5.5" | \$18.00/ea |
| INTEGRA/MILTEX | MIL9-102 | 4.5" | \$80.43/ea |

Mayo Dissecting Scissors

| Vendor | Item# | Details | Price |
|-----------------------|----------|---------------------------------|------------|
| GERMAN | 01-308 | 6.75" Tungsten Carbide Straight | \$86.00/ea |
| | 01-309 | 6.75" Tungsten Carbide Curved | \$86.00/ea |
| INTEGRA/MILTEX | MIL5-120 | 5.5" Straight | \$62.67/ea |
| | MIL5-124 | 6.75" Straight | \$73.38/ea |
| | MIL5-126 | 6.75" Curved | \$78.63/ea |

Mayo Scissors

| Vendor | Item# | Details | Price |
|------------------|------------------|-------------------------------|----------------|
| ECONOMY | 4-300 | 5.5" Straight | \$2.95/ea |
| | 4-301 | 5.5" Curved | \$2.95/ea |
| | 4-302 | 6.75" Straight | \$3.95/ea |
| | 4-303 | 6.75" Curved | \$3.95/ea |
| MID GRADE | 4-301-S | 5.5", Curved, Satin Finish | \$5.95/ea |
| | 4-300-S | 5.5", Straight, Satin Finish | \$5.95/ea |
| | 4-303-S | 6.75", Curved, Satin Finish | \$6.95/ea |
| | 4-302-S | 6.75", Straight, Satin Finish | \$6.95/ea |
| GERMAN | 01-122 | 5.5" Straight | \$19.00/ea |
| | 01-123 | 5.5" Curved | \$19.00/ea |
| | 01-124 | 6.75" Straight | \$19.00/ea |
| | 01-125 | 6.75" Curved | \$19.00/ea |
| | JORGENSEN | JOR77CWA | Curved, 5 1/2" |
| | JOR77CWB | Curved, 6 3/4" | \$25.80/ea |
| | JOR77SWA | Straight, 5" | \$22.80/ea |
| | JOR77SWB | Straight, 7" | \$24.70/ea |
| | JOR77AC | Economy, Curved, 7" | \$7.60/ea |
| | JOR77BC | Economy, Serrated, Curved | \$8.00/ea |
| | JOR77BS | Economy, Serrated, Straight | \$7.20/ea |
| | JOR77AS | Economy, Straight, 7" | \$6.40/ea |

Metzenbaum Scissors

| Vendor | Item# | Details | Price | |
|------------------|-----------------------|--|---------------|------------|
| ECONOMY | 4-320 | 5.75" Straight | \$3.95/ea | |
| | 4-321 | 5.75" Curved | \$3.95/ea | |
| | 4-322 | 7" Straight | \$3.95/ea | |
| | 4-323 | 7" Curved | \$3.95/ea | |
| MID GRADE | 4-320-S | 5.75", Straight, Satin Finish | \$6.95/ea | |
| | 4-321-S | 5.75", Curved, Satin Finish | \$6.95/ea | |
| | 4-322-S | 7", Straight, Satin Finish | \$6.95/ea | |
| | 4-323-S | 7", Curved, Satin Finish | \$6.95/ea | |
| GERMAN | 01-128 | 5.5" Straight | \$21.00/ea | |
| | 01-129 | 5.5" Curved | \$21.00/ea | |
| | 01-130 | 7" Straight | \$21.00/ea | |
| | 01-131 | 7" Curved | \$21.00/ea | |
| | 01-155 | 5.75" Curved Tungsten Carbide | \$78.00/ea | |
| | 01-320 | 9" Curved Tungsten Carbide | \$99.00/ea | |
| | INTEGRA/MILTEX | MIL5-179 | 5.5" Straight | \$77.54/ea |
| | | MIL5-180 | 5.5" Curved | \$82.94/ea |
| MIL5-181 | | 7" Straight | \$89.87/ea | |
| MIL5-182 | | 7" Curved | \$91.88/ea | |
| MIL5-186 | | 9" Straight | \$120.31/ea | |
| MIL5-190 | | 11" (27.9 cm), (NELSON), straight Standard Pattern | \$156.01/ea | |
| MIL5-284 | | 5" Curved Delicate | \$95.83/ea | |

Scissors



Mayo-Stille Scissors



| Vendor | Item# | Details | Price |
|---------------|--------|----------------|------------|
| GERMAN | 12-167 | 5.5" Curved | \$32.00/ea |
| | 12-168 | 5.5" Straight | \$32.00/ea |
| | 12-169 | 6.75" Curved | \$32.00/ea |
| | 12-170 | 6.75" Straight | \$32.00/ea |

Northbent Stitch Scissors

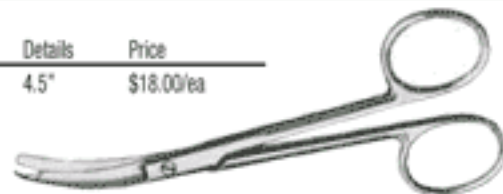

| Vendor | Item# | Details | Price |
|---------------|--------|---------|------------|
| GERMAN | 02-116 | 4.5" | \$18.00/ea |

Operating Scissors



| Vendor | Item# | Details | Price |
|------------------|---------|---|-----------|
| ECONOMY | 4-180 | 4.5" Sharp/Blunt Straight | \$2.95/ea |
| | 4-200 | 4.5" Sharp/Sharp Curved | \$2.95/ea |
| | 4-201 | 4.5" Blunt/Blunt Straight | \$2.95/ea |
| | 4-202 | 4.5" Sharp/Blunt Curved | \$2.95/ea |
| | 4-204 | 4.5" Blunt/Blunt Curved | \$2.95/ea |
| | 4-221 | 4.5" Sharp/Sharp Straight | \$2.95/ea |
| | 4-220 | 5.5" Sharp/Blunt Straight | \$2.95/ea |
| | 4-222 | 5.5" Sharp/Sharp Straight | \$2.95/ea |
| | 4-223 | 5.5" Sharp/Blunt Curved | \$2.95/ea |
| | 4-224 | 5.5" Sharp/Sharp Curved | \$2.95/ea |
| | 4-226 | 5.5" Blunt/Blunt Straight | \$2.95/ea |
| | 4-228 | 6.5" Blunt/Blunt Straight | \$2.95/ea |
| | 4-230 | 5.5" Blunt/Blunt Curved | \$2.95/ea |
| | 4-232 | 6.5" Blunt/Blunt Curved | \$2.95/ea |
| | 4-240 | 6.5" Sharp/Blunt Straight | \$3.95/ea |
| | 4-241 | 6.5" Sharp/Sharp Straight | \$3.95/ea |
| | 4-244 | 6.5" Sharp/Blunt Curved | \$3.95/ea |
| MID GRADE | 4-180-S | 4 1/2", Sharp/Blunt Straight Satin Finish | \$5.95/ea |
| | 4-200-S | 4.5", Sharp/Sharp, Curved, Satin Finish | \$5.95/ea |
| | 4-201-S | 4.5", Blunt/Blunt, Straight, Satin Finish | \$5.95/ea |
| | 4-202-S | 4 1/2", Sharp/Blunt, Curved, Satin Finish | \$5.95/ea |
| | 4-204-S | 4 1/2", Blunt/Blunt, Curved, Satin Finish | \$5.95/ea |
| | 4-221-S | 4 1/2", Sharp/Sharp, Straight, Satin Finish | \$5.95/ea |
| | 4-220-S | 5.5", Sharp/Blunt, Straight Satin Finish | \$5.95/ea |
| | 4-222-S | 5.5", Sharp/Sharp, Straight, Satin Finish | \$5.95/ea |
| | 4-223-S | 5.5", Sharp/Blunt, Curved, Satin Finish | \$5.95/ea |
| | 4-224-S | 5.5", Sharp/Sharp, Curved, Satin Finish | \$5.95/ea |
| | 4-226-S | 5 1/2", Blunt/Blunt, Straight, Satin Finish | \$5.95/ea |
| | 4-228-S | 6 1/2", Blunt/Blunt, Straight, Satin Finish | \$5.95/ea |
| | 4-230-S | 5 1/2", Blunt/Blunt, Curved, Satin Finish | \$5.95/ea |
| | 4-232-S | 6 1/2", Blunt/Blunt, Curved, Satin Finish | \$5.95/ea |
| | 4-240-S | 6.5", Sharp/Blunt, Straight, Satin Finish | \$6.95/ea |
| | 4-241-S | 6.5", Sharp/Sharp, Straight, Satin Finish | \$6.95/ea |
| | 4-244-S | 6.5", Sharp/Blunt, Curved, Satin Finish | \$6.95/ea |

| Vendor | Item# | Details | Price |
|---------------|--------|----------------------------|------------|
| GERMAN | 01-100 | 4.5" Sharp/Blunt Straight | \$19.00/ea |
| | 01-101 | 4.5" Blunt/Blunt Straight | \$19.00/ea |
| | 01-102 | 4.5" Sharp/Sharp Straight | \$19.00/ea |
| | 01-103 | 4.5" Sharp/Blunt Curved | \$19.00/ea |
| | 01-104 | 4.5" Blunt/Blunt Curved | \$19.00/ea |
| | 01-105 | 4.5" Sharp/Sharp Curved | \$19.00/ea |
| | 01-108 | 5.5" Sharp/Blunt Straight | \$19.00/ea |
| | 01-109 | 5.5" Blunt/Blunt Straight | \$19.00/ea |
| | 01-110 | 5.5" Sharp/Sharp Straight | \$19.00/ea |
| | 01-111 | 5.5" Sharp/Blunt Curved | \$19.00/ea |
| | 01-112 | 5.5" Blunt/Blunt Curved | \$19.00/ea |
| | 01-113 | 5.5" Sharp/Sharp Curved | \$19.00/ea |
| | 01-114 | 6.5" Sharp/Blunt Straight | \$19.00/ea |
| | 01-115 | 6.5" Blunt/Blunt, Straight | \$19.00/ea |
| | 01-116 | 6.5" Sharp/Sharp Straight | \$19.00/ea |
| | 01-117 | 6.5" Sharp/Blunt Curved | \$19.00/ea |
| | 01-118 | 6.5" Blunt/Blunt Curved | \$19.00/ea |
| | 01-119 | 6.5" Sharp/Sharp Curved | \$19.00/ea |

| Vendor | Item# | Details | Price |
|-----------------------|---------|---------------------------|------------|
| INTEGRA/MILTEX | MIL5-12 | 4.5" Sharp/Blunt Straight | \$51.89/ea |
| | MIL5-14 | 5" Sharp/Blunt Straight | \$52.45/ea |
| | MIL5-16 | 5.5" Sharp/Blunt Straight | \$53.40/ea |
| | MIL5-18 | 6.5" Sharp/Blunt Straight | \$61.43/ea |
| | MIL5-2 | 4.5" Sharp/Sharp Straight | \$51.89/ea |
| | MIL5-22 | 4.5" Blunt/Blunt Straight | \$51.89/ea |
| | MIL5-24 | 5" Blunt/Blunt Straight | \$52.45/ea |
| | MIL5-26 | 5.5" Blunt/Blunt Straight | \$53.40/ea |
| | MIL5-36 | 5.5" Sharp/Sharp Curved | \$60.34/ea |
| | MIL5-38 | 6.5" Sharp/Sharp Curved | \$69.90/ea |
| | MIL5-4 | 5" Sharp/Sharp Straight | \$52.45/ea |
| | MIL5-42 | 4.5" Sharp/Blunt Curved | \$56.59/ea |
| | MIL5-46 | 5.5" Sharp/Blunt Curved | \$60.34/ea |
| | MIL5-48 | 6.5" Sharp/Blunt Curved | \$68.24/ea |
| | MIL5-52 | 4.5" Blunt/Blunt Curved | \$56.59/ea |
| | MIL5-56 | 5.5" Blunt/Blunt Curved | \$60.34/ea |
| | MIL5-58 | 6.5" Blunt/Blunt Curved | \$70.31/ea |
| | MIL5-6 | 5.5" Sharp/Sharp Straight | \$53.40/ea |
| | MIL5-8 | 6.5" Sharp/Sharp Straight | \$62.67/ea |

Instruments

Scissors



Jorvet Post Mortem Scissors

Heavy-duty scissors with one serrated edge and black finished rings. **Jorvet**

| Vendor | Item# | Details | Price |
|------------------|--------|---------------------------|------------|
| JORGENSEN | JOR75N | 2" cutting blade, 7 3/4"L | \$25.50/ea |



Strabismus Scissors

| Vendor | Item# | Details | Price |
|---------------|--------|---------------|------------|
| GERMAN | 01-142 | 4.5" Straight | \$48.00/ea |
| | 01-143 | 4.5" Curved | \$48.00/ea |



Serrated Spay Scissors

Serrated, Curved Spay Scissors. 12".

| Vendor | Item# | Details | Price |
|------------------|--------|---------|------------|
| JORGENSEN | JOR87 | 12" | \$33.00/ea |
| | JOR87L | 16" | \$36.00/ea |



Ribbon Iris Scissors

| Vendor | Item# | Details | Price |
|---------------|--------|----------------|------------|
| GERMAN | 14-110 | 4.25" Curved | \$59.00/ea |
| | 14-111 | 4.25" Straight | \$59.00/ea |



Spencer Stitch Scissors

| Vendor | Item# | Details | Price |
|-----------------------|----------|-------------------------|------------|
| ECONOMY | 4-360 | 3.5" | \$2.95/ea |
| MID GRADE | 4-360-S | 3.5", Satin Finish | \$5.95/ea |
| JORGENSEN | JOR76SW | German, 3 1/2" x 3 1/2" | \$28.00/ea |
| | JOR76W | German, 5 1/2" | \$28.00/ea |
| GERMAN | 02-112 | 3.5" | \$17.00/ea |
| INTEGRA/MILTEX | MIL9-100 | 3" | \$69.61/ea |



Stevens Tenotomy Scissors

| Vendor | Item# | Details | Price |
|-----------------------|------------|--|-------------|
| JORGENSEN | JOR75TB | Straight, Blunt, 4 1/4" (10.8cm) x 4 1/4" (10.8cm) | \$25.50/ea |
| | JOR75TS | Straight, Pointed, 4 1/4" (10.8cm) x 4 1/4" (10.8cm) | \$25.50/ea |
| GERMAN | 01-250 | 4.25" Straight | \$28.00/ea |
| | 01-251 | 4.25" Curved | \$28.00/ea |
| INTEGRA/MILTEX | MIL18-1470 | 4.25" Straight | \$102.62/ea |
| | MIL18-1474 | 4.25" Curved | \$109.97/ea |
| | MIL18-1476 | 4-1/2" (11.4 cm), curved, long blades, blunt point | \$109.97/ea |
| | MIL18-1466 | 4-1/8" (10.5 cm), curved, short blades, blunt points | \$109.97/ea |



Stitch Scissors

| Vendor | Item# | Details | Price |
|------------------|---------|----------------|------------|
| JORGENSEN | JOR76SW | German, 3 1/2" | \$28.00/ea |
| | JOR76W | German, 5 1/2" | \$28.00/ea |



Super Cut Mayo Scissors

| Vendor | Item# | Details | Price |
|------------------|----------|-------------------------|-------------|
| JORGENSEN | JOR910SC | Curved, 5 1/2" (14cm) | \$105.00/ea |
| | JOR910C | Curved, 6 3/4" (17cm) | \$101.00/ea |
| | JOR910SA | Straight, 5 1/2" (14cm) | \$101.00/ea |
| | JOR910S | Straight, 6 3/4" (17cm) | \$101.00/ea |



Super Cut Metzenbaum Scissors

| Vendor | Item# | Details | Price |
|------------------|----------|-----------------------|-------------|
| JORGENSEN | JOR911CA | Curved, 5 3/4" (14cm) | \$102.00/ea |
| | JOR911C | Curved, 7" (18cm) | \$102.00/ea |
| | JOR911S | Straight, 7" (18cm) | \$123.00/ea |



Supercut Gradle Scissors

| Vendor | Item# | Details | Price |
|-----------------------|---------------|---------------|-------------|
| INTEGRA/MILTEX | MIL18-SC-1652 | 3-3/4" CURVED | \$153.28/ea |



Supercut Mayo Scissors

| Vendor | Item# | Details | Price |
|-----------------------|-------------|------------------------|-------------|
| INTEGRA/MILTEX | MIL5-SC-122 | 5-1/2" (14 cm), curved | \$131.06/ea |



Jorvet Surgical Scissors

| Vendor | Item# | Details | Price |
|------------------|---------|---------------------------------------|------------|
| JORGENSEN | JOR75CW | German, Straight, Sharp/Blunt, 5 1/2" | \$22.00/ea |



Vise Grip Style Pin Removal Forceps

Jorvet

| Vendor | Item# | Details | Price |
|------------------|---------|----------------------------|------------|
| JORGENSEN | JOR442Q | Stainless steel 7" (175mm) | \$99.00/ea |



Instruments

Scissors & Nail Nippers



Utility Bandage Scissors



| Vendor | Item# | Details | Price |
|-----------------------|-----------|---------|------------|
| ECONOMY | 3-169 | 5.5" | \$3.95/ea |
| | 3-170 | 7.5" | \$3.95/ea |
| GERMAN | 02-109 | 7.5" | \$7.00/ea |
| INTEGRA/MILTEX | MIL5-1000 | 7.5" | \$21.51/ea |
| | MIL5-998 | 6.5" | \$21.51/ea |

Universal Lister Scissors

Universal Lister Bandage Scissors. Black. 5 1/2".
Smaller than JOR75u.



| Vendor | Item# | Details | Price |
|------------------|---------|------------------------------------|-----------|
| JORGENSEN | JOR75U | 7 1/2" | \$9.40/ea |
| | JOR75US | Black, 5 1/2" Smaller than JOR75u. | \$9.00/ea |

Anvil Nail Splitting Forceps



| Vendor | Item# | Details | Price |
|-----------------------|-----------|---------|-------------|
| GERMAN | 35-120 | 5" | \$36.00/ea |
| INTEGRA/MILTEX | MIL40-230 | 5" | \$144.86/ea |

Barrel Spring Nail Nipper

INTEGRA *MilTex*



| Vendor | Item# | Details | Price |
|-----------------------|-----------|----------------------------------|------------|
| GERMAN | 35-125 | 4.5", Concave | \$29.00/ea |
| | 35-125SS | 4.5" Single Spring | \$29.00/ea |
| | 35-127 | 5.5", Convex | \$39.00/ea |
| INTEGRA/MILTEX | MIL40-205 | 4.5" Concave Jaws, Barrel spring | \$47.71/ea |
| | MIL40-207 | 5.5" Concave Jaws, Barrel spring | \$59.15/ea |

Double Action Nail Nipper



| Vendor | Item# | Details | Price |
|---------------|--------|-----------------|------------|
| GERMAN | 35-129 | 5 1/2", Concave | \$72.00/ea |

Westcott Tenotomy Scissors



NEW

| Vendor | Item# | Details | Price |
|-----------------------|------------|---------------------------------------|-------------|
| INTEGRA/MILTEX | MIL18-1487 | 5-1/4" (13.3 cm), right, wide handles | \$252.96/ea |

White's Toenail Scissors



| Vendor | Item# | Details | Price |
|------------------|--------|-----------------|------------|
| JORGENSEN | JOR84 | 4" | \$6.60/ea |
| | JOR84G | German-made, 4" | \$33.00/ea |
| GERMAN | 01-228 | 4.75 | \$35.00/ea |

Wire Cutting Scissors



| Vendor | Item# | Details | Price |
|------------------|---------|-------------------------------|------------|
| MID GRADE | 4-380-S | 5", Satin Finish | \$5.95/ea |
| GERMAN | 14-120 | 4 3/4", Angle Serrated German | \$19.00/ea |
| | 14-121 | 4.25" Curved | \$20.00/ea |
| | 14-123 | 4.25" Straight | \$18.00/ea |

Double Spring Nail Nipper

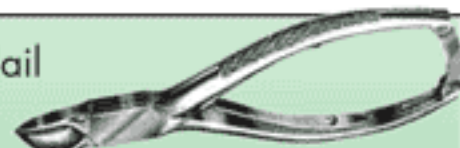

| Vendor | Item# | Details | Price |
|-----------------------|-------------|---------------------|-------------|
| GERMAN | 35-130 | 7" | \$36.00/ea |
| | 35-132 | 6" Straight | \$36.00/ea |
| | 35-134 | 5.5" Concave | \$36.00/ea |
| | 35-138 | 5.5" Angled Concave | \$36.00/ea |
| | 35-136 | 6.5" Concave | \$36.00/ea |
| INTEGRA/MILTEX | MIL40-210SS | 5.5" Concave | \$161.37/ea |

Hoof Crease Nail Puller



| Vendor | Item# | Details | Price |
|------------------|---------|----------------------|------------|
| JORGENSEN | JOR1024 | 12" (30cm) Stainless | \$39.00/ea |

Hoof nipper or trimmer

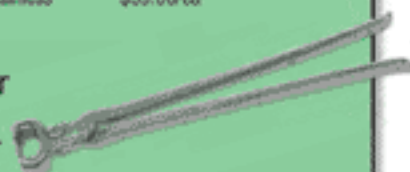

| Vendor | Item# | Price |
|------------------|----------|------------|
| JORGENSEN | JOR1024B | \$42.00/ea |

Nail Nippers

Nail Splitter

INTEGRA *Militec*



| Vendor | Item# | Details | Price |
|---------------|--------------|--|-------------|
| MILTEX | MIL40-226A | Straight Jaws, Extra Narrow, Double Spring | \$157.67/ea |
| MILTEX | MIL40-226-SS | 5" Straight, Double Spring | \$156.31/ea |

Equine Shoe Puller/Spreader

Jorvet

To remove the shoes or also to adjust a shoe by spreading it for a better fit.



| Vendor | Item# | Details | Price |
|------------------|----------|----------------------|------------|
| JORGENSEN | JOR1024A | 12" (30cm) Stainless | \$42.00/ea |

Tissue/Cuticle Nipper

INTEGRA *Militec*



| Vendor | Item# | Details | Price |
|---------------|-------------|---------|------------|
| GERMAN | 35-117 | 4.5" | \$36.00/ea |
| MILTEX | MIL40-250SS | 4.5" | \$97.47/ea |

Bone Plate Holding Forceps

| Vendor | Item# | Details | Price |
|------------------|---------|-------------|-------------|
| JORGENSEN | JOR212P | 6" (15 cm). | \$133.00/ea |

Bone Holding Forceps

| Vendor | Item# | Details | Price |
|------------------|---------|-----------------------------|-------------|
| GERMAN | 33-150 | 7" | \$58.00/ea |
| JORGENSEN | JOR159M | 10cm, 4"Medium, 135mm. | \$105.00/ea |
| | JOR213 | Stainless steel, 15 cm. 6". | \$133.00/ea |

Bone Fragment Forceps

| Vendor | Item# | Details | Price |
|------------------|---------|--------------------|-------------|
| GERMAN | 13-114 | 6" | \$34.00/ea |
| JORGENSEN | JOR212 | 6" Stainless Steel | \$133.00/ea |
| | JOR212M | Medium, 135mm. | \$119.00/ea |

Kern Holding Forceps

| Vendor | Item# | Details | Price |
|-----------------------|---------|---------|-------------|
| GERMAN | 33-142 | 6" | \$98.00/ea |
| | 33-146 | 9" | \$120.00/ea |
| INTEGRA/MILTEX | MIL27-2 | 8.5" | \$320.37/ea |

Baby Kerns Bone Forceps

| | | | |
|------------------|---------|---------------------|-------------|
| JORGENSEN | JOR159 | 15cm, 6" | \$147.00/ea |
| | JOR159L | Standard, 8" (21cm) | \$169.00/ea |

Mini Baby Kerns Bone Holding Forceps

| | | | |
|------------------|---------|----------|-------------|
| JORGENSEN | JOR159M | 10cm, 4" | \$105.00/ea |
|------------------|---------|----------|-------------|

Liston Bone Cutting Forceps

| Vendor | Item# | Details | Price |
|------------------|---------|----------------------------------|-------------|
| GERMAN | 33-157 | 7.5" Straight | \$76.00/ea |
| | 33-157A | 7.5" Angled | \$76.00/ea |
| | 33-162 | 10.5" Straight | \$150.00/ea |
| JORGENSEN | JOR223 | German, Stainless Steel, 5 1/2". | \$170.00/ea |

Ruskin-Liston Bone Cutting Forceps

| Vendor | Item# | Details | Price |
|------------------|---------|-----------------------------|-------------|
| GERMAN | V-375 | 7.5" Double Action Straight | \$99.00/ea |
| | V-375B | 7.5" Double Action Curved | \$170.00/ea |
| JORGENSEN | JOR223A | 5.5" Double Action Straight | \$210.00/ea |
| | JOR223B | 7.5" Double Action Straight | \$220.00/ea |

Twin Point Fragment Forceps

| Vendor | Item# | Details | Price |
|------------------|----------|----------------------|-------------|
| JORGENSEN | JOR212TS | Straight Tip, 6 1/2" | \$123.00/ea |
| Jorvet | JOR212TC | Curved Tip, 6 1/2" | \$133.00/ea |

NEW

Jorvet Small Fragment Forceps

Single pointed reduction forceps typically applies pressure at the exact point where it is desirable to place an implant.

| Vendor | Item# | Details | Price |
|------------------|----------|---|-------------|
| JORGENSEN | JOR212S | 5 1/4" | \$122.00/ea |
| | JOR212L | Extra Large, 8". May be used to provide temporary stabilization of osteotomy while the plate is contoured and placed. | \$128.00/ea |
| | JOR212LS | Large, Spin Lock Closure, 7 1/2" | \$163.00/ea |
| | JOR212M | Medium, 135mm. | \$119.00/ea |

Jorvet Small Angles Bone Cutter

Especially useful for small dogs and cats. The jaws have the ideal size and angle for:

- Femoral head and neck excision
- Tibial crest translocation
- Many other small bone cutting procedures

Jorvet

| Vendor | Item# | Details | Price |
|------------------|---------|------------------------------------|-------------|
| JORGENSEN | JOR223S | 15mm blade, 6 1/2" (170mm) length. | \$125.00/ea |

Instruments

Rongeurs



Beyer Rongeur



| Vendor | Item# | Details | Price |
|---------------|--------|---------------------------|-------------|
| GERMAN | 33-163 | 7", Double Action 3mm Jaw | \$150.00/ea |

Bone Rongeur



| Vendor | Item# | Details | Price |
|---------------|---------|----------------------|-------------|
| GERMAN | 33-162A | 10.5", Double Action | \$150.00/ea |

Duck-Billed Mini Rongeur



| Vendor | Item# | Details | Price |
|------------------|--------|-------------------------|-------------|
| JORGENSEN | JOR224 | 2mm bite. 5 1/4" 5 1/4" | \$164.00/ea |
| GERMAN | V-415 | 5.25" | \$82.00/ea |

Leksell Rongeur



| Vendor | Item# | Details | Price |
|---------------|--------|---------------------------|-------------|
| GERMAN | 33-164 | 8", Double Action 3mm jaw | \$150.00/ea |

Lempert Rongeur



| Vendor | Item# | Details | Price |
|---------------|--------|-------------------------------------|------------|
| GERMAN | 33-160 | 7", Single Action, Slight curve 3mm | \$98.00/ea |
| | 33-256 | 6.5", 2.5 x 10mm Straight | \$99.00/ea |

Micro Friedman Rongeur



| Vendor | Item# | Details | Price |
|------------------|---------|---|-------------|
| GERMAN | 36-102 | 1.3mm , Curved | \$99.00/ea |
| | 36-103 | 1.3mm , Straight | \$99.00/ea |
| JORGENSEN | JOR224F | Very delicate. 5 1/2" (14cm) Curved Jaw, 1.3mm W. | \$102.00/ea |



Ecklin-Duckbill Rongeur



| Vendor | Item# | Details | Price |
|------------------|---------|---------|----------------|
| JORGENSEN | JOR225E | 8 1/2" | \$190.00/ea/ea |

Equine Dental Compound Rongeur

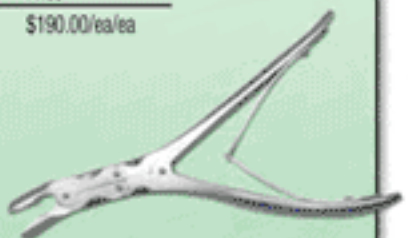

| Vendor | Item# | Details | Price |
|------------------|---------|-----------|-------------|
| JORGENSEN | JOR225X | 9" length | \$110.00/ea |

Laminectomy Rongeurs



| Vendor | Item# | Details | Price |
|------------------|-----------|-----------------------|-------------|
| JORGENSEN | JOR225LRA | 2mm x 16cm 2mm x 16cm | \$135.00/ea |
| | JOR225LRB | 3mm x 16cm 3mm x 16cm | \$135.00/ea |
| | JOR225LRC | 4mm x 16cm 4mm x 16cm | \$135.00/ea |



Oral Surgery Rongeur



| Vendor | Item# | Details | Price |
|-----------------------|-----------|--|-------------|
| INTEGRA/MILTEX | MIL22-486 | 5 1/2" (14 cm), no. 4 pattern, slightly curved beaks | \$256.30/ea |

Ruskin Rongeur

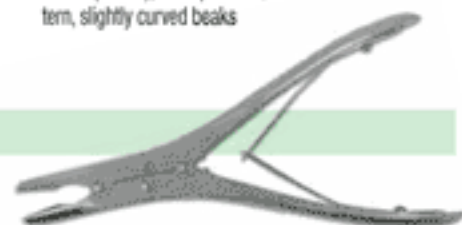

| Vendor | Item# | Details | Price |
|------------------|---------|-------------------------------|-------------|
| JORGENSEN | JOR225C | Curved. 4mm bite. 18cm (7") | \$190.00/ea |
| | JOR225S | Straight. 4mm bite. 18cm (7") | \$190.00/ea |

Jorvet Stille-Luer Rongeur

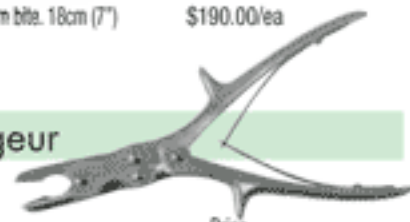

| Vendor | Item# | Details | Price |
|------------------|---------|---------------------------------|-------------|
| JORGENSEN | JOR225L | Curved. 8mm bite. 22cm (8 1/2") | \$190.00/ea |

Elevators & Chisels



Chandler Elevator



| Vendor | Item# | Details | Price |
|---------------|--------|------------|------------|
| GERMAN | 46-250 | 1/2" Taper | \$25.20/ea |
| | 46-252 | 3/4" Taper | \$28.32/ea |

Lane Elevator



| Vendor | Item# | Details | Price |
|---------------|--------|---------|------------|
| GERMAN | 33-261 | Broad | \$39.00/ea |

Freer Elevator



| Vendor | Item# | Details | Price |
|------------------|---------|-------------------------------------|------------|
| JORGENSEN | JOR226Q | Stainless Steel, German, 7" (18cm). | \$48.50/ea |

Key Perostial Elevator

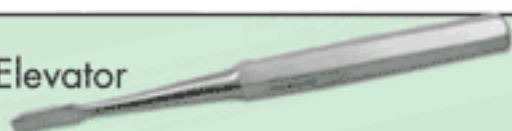

| Vendor | Item# | Details | Price |
|------------------|---------|---|------------|
| GERMAN | V-420A | 6mm | \$36.00/ea |
| | V-420B | 12mm | \$36.00/ea |
| | V-420C | 19mm | \$36.00/ea |
| JORGENSEN | JOR226A | German, Stainless Steel, 190mm. (7 1/2"), Blade, 12mm | \$64.00/ea |
| | JOR226B | German, Stainless Steel, 190mm. (7 1/2"), Blade, 19mm | \$64.00/ea |
| | JOR226C | Blade, 19mm | \$64.00/ea |

Periosteal Elevator



| Vendor | Item# | Details | Price |
|------------------|---------|---|------------|
| GERMAN | 33-272 | 14mm | \$50.00/ea |
| JORGENSEN | JOR226S | 180mm. (7 1/2"), Curved 6mm tipCurved 6mm tip | \$68.00/ea |
| | JOR226R | 180mm. (7 1/2"), Square 6mm tipSquare 6mm tip | \$63.50/ea |

Chisel



| Vendor | Item# | Details | Price |
|---------------|--------|---------|------------|
| GERMAN | 13-173 | 8mm | \$39.00/ea |
| | 13-174 | 10mm | \$39.00/ea |
| | 13-175 | 12mm | \$39.00/ea |
| | 13-176 | 14mm | \$39.00/ea |
| | 13-177 | 16mm | \$39.00/ea |

Jorvet Bone Chisel

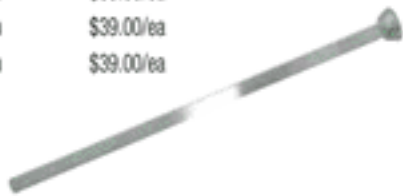

| Vendor | Item# | Details | Price |
|------------------|---------|--|------------|
| JORGENSEN | JOR227A | Stainless Steel, 6mm, 17cm L (6 1/2") | \$54.00/ea |
| | JOR227B | Stainless Steel, 12mm, 17cm L (6 1/2") | \$54.00/ea |

Jorgensen Osteotome



| Vendor | Item# | Details | Price |
|------------------|---------|--|------------|
| GERMAN | V-430 | 5" | \$28.00/ea |
| JORGENSEN | JOR228A | Stainless Steel, 13.5cm (5"), Blade 10mm W | \$42.00/ea |
| | JOR228B | Stainless Steel, 13.5cm (5"), Blade 16mm W | \$42.00/ea |

U.S Army Pattern Chisel

| Vendor | Item# | Details | Price |
|---------------|--------|---------|------------|
| GERMAN | V-425A | 6mm | \$36.00/ea |
| | V-425B | 12mm | \$36.00/ea |

Key Periosteal Elevator



| Vendor | Item# | Details | Price |
|------------------|---------|---|------------|
| JORGENSEN | JOR226C | German, Stainless Steel, 190mm. (7 1/2"), Blade, 19mm | \$64.00/ea |
| | JOR226A | German, Stainless Steel, 190mm. (7 1/2"), Blade, 6mm | \$64.00/ea |
| | JOR226B | German, Stainless Steel, 190mm. (7 1/2"), Blade, 12mm | \$64.00/ea |

Periosteal Elevator



A popular configuration available in 6mm curved tip. Lightweight fiber handle.

| Vendor | Item# | Details | Price |
|------------------|---------|---------------------------------|------------|
| JORGENSEN | JOR226S | 180mm. (7 1/2"), Curved 6mm tip | \$68.00/ea |
| | JOR226R | 180mm. (7 1/2"), Square 6mm tip | \$63.50/ea |

Lambotte Osteotome



| Vendor | Item# | Details | Price |
|-----------------------|-----------|------------|-------------|
| GERMAN | 33-224 | 4mm, 5" | \$32.00/ea |
| | 33-227 | 10mm, 5" | \$32.00/ea |
| | 33-229 | 15mm, 5" | \$32.00/ea |
| | 33-231 | 22mm, 8" | \$32.00/ea |
| | 33-232 | 4mm, 7.25" | \$32.00/ea |
| | 33-234 | 6mm, 7.25" | \$32.00/ea |
| | 33-235 | 10mm, 7.5" | \$32.00/ea |
| | 33-236 | 12mm, 7.5" | \$32.00/ea |
| | 33-238 | 19mm, 7.5" | \$32.00/ea |
| | 33-248 | 25mm, 9" | \$48.00/ea |
| INTEGRA/MILTEX | MIL27-488 | 6mm, 9" | \$109.42/ea |
| | MIL27-490 | 13mm, 9" | \$111.08/ea |

Rasps & Currettes



Excision Rasp

| Vendor | Item# | Details | Price |
|-----------|--------|--|------------|
| JORGENSEN | JOR209 | Excision Arthroplasty, Stainless steel, 17cm or 6.5" in length | \$66.00/ea |

Putti Bone Rasp

| Vendor | Item# | Details | Price |
|--------|--------|---------------------------|----------|
| GERMAN | 33-362 | 10.5", double-ended, flat | \$130.00 |

Diamond Molar Rasps

| Vendor | Item# | Details | Price |
|-----------|--------|-------------------------|------------|
| JORGENSEN | JOR41R | Rasp, Molar For Rabbits | \$36.00/ea |

Fomon Rasp

| Vendor | Item# | Details | Price |
|----------------|-----------|----------------|-------------|
| JORGENSEN | JOR209F | 8 1/4" (21cm). | \$102.00/ea |
| GERMAN | 21-276 | 8.25" | \$80.00/ea |
| INTEGRA/MILTEX | MIL21-369 | 8.25" | \$124.81/ea |

Trochlear Rasp

| Vendor | Item# | Details | Price |
|-----------|--------|---------|------------|
| JORGENSEN | JOR210 | 6.5" | \$99.00/ea |

Modular Osteotome

Jarvet

A comfortable fiber composite handle with metal end to take hammering. Blade 1.1mm in thickness. This makes a great choice for procedures like block sulcoplasty. The blades can be changed intra-operatively for proper fit during the procedure. Supplied as a complete kit with 7 different blades, or purchase handle and blades separately.

| Vendor | Item# | Details | Price |
|-----------|---------|--|------------|
| JORGENSEN | JOR1068 | handle only and screw driver for changing blades | \$90.00/ea |

Modular Osteotome Blades

Jarvet

| Vendor | Item# | Details | Price |
|-----------|-----------|---|-------------|
| JORGENSEN | JOR1068MD | 10mm | \$42.00/ea |
| | JOR1068ME | 12mm | \$42.00/ea |
| | JOR1068MF | 15mm | \$42.00/ea |
| | JOR1068MG | 20mm | \$42.00/ea |
| | JOR1068MA | 4mm | \$42.00/ea |
| | JOR1068MB | 6mm | \$42.00/ea |
| | JOR1068MC | 8mm | \$42.00/ea |
| | JOR1068MK | Handle and set of all 7 blades, includes screw driver | \$295.00/ea |

Super-Slim Block Resection Osteotome

Jarvet

| Vendor | Item# | Price |
|-----------|----------|------------|
| JORGENSEN | JOR1068A | \$38.00/ea |

Putti Bone Rasp

| Vendor | Item# | Details | Price |
|----------------|-----------|---|-------------|
| INTEGRA/MILTEX | MIL27-702 | 12" (30.5 cm), round and half-round tapered curved ends | \$211.91/ea |

Saalfeld Comedone Extractor

| Vendor | Item# | Details | Price |
|--------|-----------|------------------------------------|------------|
| MILTEX | MIL33-204 | 5-3/4" (14.6 cm), with acne lancet | \$31.34/ea |
| MILTEX | MIL33-206 | 4-1/4" (10.8 cm), with acne lancet | \$24.28/ea |

Modified Stifle Retractor

Jarvet

Designed for medium and large dogs (the group with the highest incidence of meniscal damage), this improved model has longer jaw tips which are self-protecting when the instrument is in the closed position. Once inserted atraumatically into the stifle, distraction exposes the longer tips for maximum grip. The best instrument to examine the caudal horn of the medial meniscus.

| Vendor | Item# | Details | Price |
|-----------|----------|--------------------|-------------|
| JORGENSEN | JOR240WM | (15-50 Kg), 7 1/2" | \$213.00/ea |



Instruments

Curettes

Billeau Ear Curette

| Vendor | Item# | Details | Price |
|------------------|--------|------------|------------|
| JORGENSEN | JOR49P | German, 6" | \$24.00/ea |

Bone Curette

| Vendor | Item# | Details | Price |
|---------------|----------|--|------------|
| GERMAN | 13-127 | 5 1/2" L x Oval Cup 6 x 10mm x Round Cup 7mm Dia | \$28.00/ea |
| | 13-140 | Round 12mm | \$48.00/ea |
| | 13-141 | Round 14mm | \$48.00/ea |
| | V-405B-R | Round 3mm | \$32.00/ea |
| | V-405C-O | Oval 5mm x 7mm | \$32.00/ea |
| | V-405C-R | Round 8mm | \$32.00/ea |

| | | | |
|------------------|----------|----------------|------------|
| JORGENSEN | JOR222 | Oval 6mm x 8mm | \$37.50/ea |
| | JOR13123 | Round 3mm | \$32.00/ea |

Buck Ear Curette

| Vendor | Item# | Details | Price |
|-----------------------|-----------|-------------------------------|---------------|
| INTEGRA/MILTEX | MIL19-294 | 6-1/2", Angled Blunt Size 1 | \$37.71/ea |
| | MIL19-296 | Ang Blunt Size 2 | \$37.71/ea |
| JORGENSEN | JOR49F | Straight, Stainless steel, 6" | \$12.00/ea |
| | JOR49FG | Straight, German-made, 6" | \$18.00/ea/ea |
| | JOR49G | Curved head, 6" | \$12.00/ea/ea |

Curette (without hole)

| Vendor | Item# | Details | Price |
|-----------------------|------------|------------------------|------------|
| INTEGRA/MILTEX | MIL40-57/3 | large, 2.5 mm diameter | \$46.88/ea |

Double Ended Disposable Ear Curettes

| Vendor | Item# | Details | Price |
|------------------|----------|-----------------|------------|
| JORGENSEN | JOR1059B | Curve Loop, 3pk | \$6.30/ea |
| | JOR1059C | Mini loop, 3pk | \$6.30/ea |
| | JOR1059A | Scoop End, 3pk | \$6.30/ea |
| | JOR1059 | Set of 3 | \$6.00/set |

Double Ended Curette

| Vendor | Item# | Details | Price |
|---------------|--------|-------------|------------|
| GERMAN | 35-165 | 1.5 & 2.0mm | \$25.00/ea |
| | 35-167 | 1.5 & 2.5mm | \$25.00/ea |



Ferguson Stone Scoop

| Vendor | Item# | Details | Price |
|------------------|--------|------------------|-------------|
| JORGENSEN | JOR896 | Stainless Steel. | \$104.00/ea |

Fox Dermal Curette

| Vendor | Item# | Details | Price |
|-----------------------|----------|--------------------------------------|------------|
| INTEGRA/MILTEX | MIL33-5B | 5 1/2" (14 cm), round, 1 mm diameter | \$68.51/ea |

Jorvet Hatt Spoon Curette

| Vendor | Item# | Details | Price |
|------------------|---------|-------------------|------------|
| JORGENSEN | JOR222P | 12mm x 18mm scoop | \$73.00/ea |
| | JOR222N | 17mm x 30mm scoop | \$73.00/ea |
| | JOR222Q | 7mm x 12mm scoop | \$73.00/ea |

Jorvet House Curette

| Vendor | Item# | Details | Price |
|------------------|---------|--------------------|------------|
| JORGENSEN | JOR222H | 2.5mm + 3.0mm ends | \$47.00/ea |

Volkman Bone Curette

| Vendor | Item# | Details | Price |
|------------------|---------|--|------------|
| JORGENSEN | JOR222A | Excellent for OCD lesions. Oval cutting surface. German-made. Stainless steel. 22cm., #000 | \$37.50/ea |
| | JOR222B | Excellent for OCD lesions. Oval cutting surface. German-made. Stainless steel. 22cm., #2 | \$37.50/ea |

Dermal Curette (Sterile Disposable)

| Vendor | Item# | Details | Price |
|-----------------------|----------|---------|-------------|
| INTEGRA/MILTEX | MIL33-54 | 4MM | \$106.73/ea |

Jorvet Avian Oral Speculum

| Vendor | Item# | Details | Price |
|------------------|--------|---|------------|
| JORGENSEN | JOR51X | Small. 4 3/4" x 1/4". (i.e., parakeets) | \$10.50/ea |
| | JOR51Y | Medium. 4 3/4" x 3/8". (i.e., African grey parrots) | \$12.30/ea |
| | JOR51Z | Large. 7 1/2" x 5/8". (i.e., full-size macaws) | \$15.30/ea |
| | JOR51S | Set of 3 | \$30.00/ea |

Instruments

Retractors

Alm Retractor Sharp

| Vendor | Item# | Details | Price |
|------------------|---------|--|------------|
| JORGENSEN | JOR244A | Small exotics or avian patients, Stainless steel. 23/4" (7cm). | \$38.00/ea |



Balfour Retractor

| Vendor | Item# | Details | Price |
|------------------|---------|--|-------------|
| GERMAN | 25-170 | 7" spread | \$180.00/ea |
| JORGENSEN | JOR242L | (A) 180mm (B) 45 x 80mm 80mm 180mm, 45 x 80mm | \$240.00/ea |



Baby Balfour Retractor

| Vendor | Item# | Details | Price |
|------------------|---------|--|-------------|
| GERMAN | 25-170A | 4" spread | \$180.00/ea |
| JORGENSEN | JOR242 | for most small animals under 60 lbs Works well for most small animals under 60 lbs. | |

Barraquer Retractor

| Vendor | Item# | Details | Price |
|---------------|--------|---------|------------|
| GERMAN | 33-100 | 10mm | \$13.00/ea |



Barraquer Eyelid Speculum

| Vendor | Item# | Details | Price |
|------------------|--------|------------------|------------|
| JORGENSEN | JOR688 | 13.4" 15mm blade | \$34.50/ea |

Castroviejo Eye Speculum

| Vendor | Item# | Details | Price |
|---------------|--------|---------|------------|
| GERMAN | 20-105 | 3.5" | \$98.00/ea |

Covault Retractor

| Vendor | Item# | Details | Price |
|---------------|--------|---------|------------|
| GERMAN | 27-501 | 8" | \$17.00/ea |



Eyelid Retractor

| Vendor | Item# | Price |
|------------------|-------|------------|
| JORGENSEN | JOR68 | \$18.00/ea |



Gelpi Retractor

| Vendor | Item# | Details | Price |
|------------------|--------|-----------|------------|
| ECONOMY | 22-120 | 6.75" | \$30.00/ea |
| GERMAN | 22-135 | 3.5" | \$75.00/ea |
| | 22-137 | 5.5" | \$75.00/ea |
| | 22-150 | 7.5" | \$75.00/ea |
| JORGENSEN | JOR240 | 18cm (7") | \$96.00/ea |

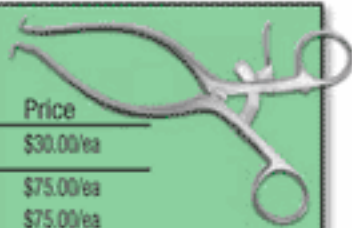

Mini Gelpi Retractor

| Vendor | Item# | Details | Price |
|------------------|----------|---------|-------------|
| JORGENSEN | JOR240ME | Economy | \$36.00/ea |
| | JOR240M | German | \$117.00/ea |
| | JOR240S | Small | \$87.00/ea |



Super Mini Gelpi Retractor

| Vendor | Item# | Price |
|------------------|----------|------------|
| JORGENSEN | JOR240MA | \$59.00/ea |



Gillies Retractor Fine

| Vendor | Item# | Details | Price |
|------------------|---------|------------|------------|
| JORGENSEN | JOR243G | 7" (18cm). | \$27.00/ea |



Harrington Retractor

| Vendor | Item# | Details | Price |
|-----------------------|-----------|---------|-------------|
| INTEGRA/MILTEX | MIL11-316 | 12" | \$211.78/ea |



Hauptman OHE Retractor

| Vendor | Item# | Details | Price |
|------------------|---------|---------------------|-------------|
| JORGENSEN | JOR925 | Cat/Small Dog | \$119.00/ea |
| | JOR925X | CD ROM Instructions | \$3.00/ea |
| | JOR925B | Large Dog | \$119.00/ea |
| | JOR925A | Medium Dog | \$119.00/ea |
| | JOR925C | Set of 3 | \$321.00/ea |

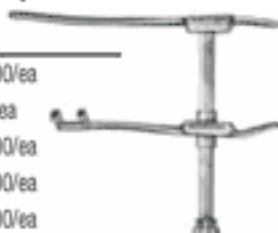

Heaney Retractor

| Vendor | Item# | Details | Price |
|-----------------------|-----------|--|------------|
| INTEGRA/MILTEX | MIL11-182 | 10-1/2" (26.7 cm), blade 1-1/8" (2.8 cm) x 2-7/8" (7.3 cm) | \$98.19/ea |



Hohman Retractor

| Vendor | Item# | Details | Price |
|------------------|---------|--|------------|
| GERMAN | V-450A | 12mm | \$32.00/ea |
| | V-450B | 18mm | \$32.00/ea |
| JORGENSEN | JOR235A | 12mm W x 24cm L (9"). Medium breeds | \$67.00/ea |
| | JOR235B | 18mm W x 24cm L (9 1/2"). Large breeds | \$81.00/ea |
| | JOR235C | 8mm | \$61.00/ea |



Mini Hohman Retractor

| Vendor | Item# | Details | Price |
|------------------|---------|------------|------------|
| GERMAN | 33-361 | 6.5" x 8mm | \$30.00/ea |
| JORGENSEN | JOR235M | 6mm x 16cm | \$45.00/ea |



Super Mini 4mm Hohman Retractor

greatly improve exposure and access in the small surgical field of joint surgery. Stainless steel.

| Vendor | Item# | Details | Price |
|------------------|----------|----------------|------------|
| JORGENSEN | JOR235MA | 6 1/2 L x 4 mm | \$62.00/ea |

Dandy Nerve Hook

| Vendor | Item# | Details | Price |
|---------------|------------|------------------------|------------|
| MILTEX | MIL26-1150 | 9" (22.9 cm), straight | \$75.30/ea |



Instruments

Retractors & Specula

Lip Retractor

| Vendor | Item# | Details | Price |
|------------------|---------|-------------------------------|------------|
| JORGENSEN | JOR1056 | 6 1/2" long and autoclavable. | \$21.00/ea |

DesMarres Lip Retractor

| Vendor | Item# | Details | Price |
|------------------|----------|---------------------|------------|
| JORGENSEN | JOR243XB | 10mm, 16cm (6 1/4") | \$28.50/ea |
| | JOR243XC | 12mm, 16cm (6 1/4") | \$30.00/ea |
| | JOR243XA | 8mm, 16cm (6 1/4") | \$28.50/ea |

The Lone Star Veterinary Retractor System

The Lone Star Veterinary Retractor System consists of two components, the autoclavable plastic ring and the accessory elastic stays. Because of its unique design, the retractor ring easily can be adapted to the patient's anatomy. The elastic stays allow the surgeon flexibility over the amount of tension applied and precise retraction of the incision without obstruction. Prep and drape patient in usual manner, then apply the retractor.

| Vendor | Item# | Details | Price |
|------------------|---------|----------------------------|-------------|
| JORGENSEN | JOR4407 | Retractor Ring Only, Small | \$119.00/ea |
| | JOR4405 | Retractor Ring Only, Large | \$132.00/ea |
| | JOR4411 | Elastic Stays Only, 8 Pack | \$61.00/ea |

Retractor Guards

| Vendor | Item# | Details | Price |
|------------------|--------|--------------------------|------------|
| JORGENSEN | JOR929 | Assorted pack of 3 sizes | \$26.60/ea |

Ribbon Retractor

| Vendor | Item# | Details | Price |
|-----------------------|-----------|------------|------------|
| INTEGRA/MILTEX | MIL11-130 | 3/4" x 13" | \$36.98/ea |

Baby Ribbon Retractor

| Vendor | Item# | Details | Price |
|-----------------------|-----------|-----------|------------|
| INTEGRA/MILTEX | MIL11-144 | 5/8" x 8" | \$34.96/ea |

Skin Retractor

| Vendor | Item# | Details | Price |
|------------------|-----------|------------------|------------|
| ECONOMY | 12-1465 | 5" | \$1.95/ea |
| MID GRADE | 12-1465-S | 5", Satin Finish | \$4.95/ea |
| GERMAN | 27-502 | 4.75" | \$17.00/ea |

Senn Retractor

| Vendor | Item# | Details | Price |
|-----------------------|----------|-------------|------------|
| ECONOMY | 12-1450 | 6.25" Sharp | \$4.30/ea |
| | 12-1455 | 6.25" Blunt | \$4.95/ea |
| GERMAN | 21-332 | 6.25" Sharp | \$18.00/ea |
| | 21-333 | 6.25" Blunt | \$18.00/ea |
| INTEGRA/MILTEX | MIL11-76 | 6.25 Sharp | \$60.75/ea |

Senn Retractor w/Blunt Prongs

| Vendor | Item# | Details | Price |
|------------------|---------|---------------|------------|
| JORGENSEN | JOR243B | 16cm (6 1/4") | \$10.00/ea |

Senn-Mueller Retractor

Double end retractor. Three sharp hooks on one end and a wide plate on the other end.

| Vendor | Item# | Details | Price |
|------------------|--------|---------------|------------|
| JORGENSEN | JOR243 | 16cm (6 1/4") | \$12.00/ea |

Snook Retractor

| Vendor | Item# | Details | Price |
|-----------------------|----------|---------------|------------|
| ECONOMY | 1-100 | 8" | \$6.95/ea |
| GERMAN | 27-500 | 8" | \$17.00/ea |
| | 27-500SM | 8" small hook | \$17.00/ea |
| INTEGRA/MILTEX | MIL6-008 | 8" | \$63.91/ea |

Spay Hook

Flat, Stainless Steel, 8".

| Vendor | Item# | Details | Price |
|------------------|---------|-----------------------------------|-----------|
| JORGENSEN | JOR112A | Snook, Flat, Stainless Steel, 8". | \$9.00/ea |

Stifle Lever

Examination and management of meniscal injuries is made extremely difficult by the limited access to the medial meniscus during routine approaches. Exposure of the medial meniscus is typically achieved by either use of a stifle distractor or by a Hohman retractor. Hohman retractors are not designed for levering against articular cartilage in that the blade does not "fit" the trochlea. The stifle lever is designed to substitute the Hohman. The caudal surface of the stifle lever is contoured to fit the trochlea of large dogs. The load is dissipated over a large area minimizing trauma. The ring style handle is convenient for retraction by the surgeon using the thumb. The tip atraumatically hooks behind the caudal aspect of the tibial plateau.

| Vendor | Item# | Details | Price |
|------------------|-------|--------------------|------------|
| JORGENSEN | | 9" (225mm) length. | \$61.00/ea |

Stifle Fat Pad Retractor

| Vendor | Item# | Details | Price |
|------------------|---------|---------------|------------|
| JORGENSEN | JOR243A | 16cm (6 1/4") | \$19.50/ea |



Jorvet Stifle Retractor

| Vendor | Item# | Price |
|------------------|---------|-------------|
| JORGENSEN | JOR240W | \$210.00/ea |



Jorvet Small Stifle Retractor

The examination of the meniscus and intraarticular structure during anterior cruciate repair is a real necessity. This visualization often is difficult even in the largest of dogs. The stifle retractor allows gentle retraction between the femur and tibia, exposing the entire stifle joint to a thorough exam without damaging the joint surface. Stainless steel.

| Vendor | Item# | Details | Price |
|------------------|----------|---|-------------|
| JORGENSEN | JOR240WA | 6mm profile. The small overlapping tips allow atraumatic entry into small arthrotomies and small stifles. | \$161.00/ea |
| | JOR240WB | Tips differ by the smaller 3mm versus 6mm profile of JOR240wa. (<50 Kg), X-Small | \$158.00/ea |
| | JOR235SA | 6 1/2" (170mm) | \$61.00/ea |

Stifle Distractor w/Spinlock

The working tips on our spinlock are the same as the ratchet version. The spinlock offers more secure distraction as it is less likely to slip. The spinlock also offers an infinite range of position versus the ratchet.

| Vendor | Item# | Details | Price |
|------------------|-----------|---------|-------------|
| JORGENSEN | JOR240WAS | | \$180.00/ea |
| | JOR240WBS | X-Small | \$180.00/ea |



U.S Army Retractor

| Vendor | Item# | Details | Price |
|-----------------------|-----------|---------|------------|
| ECONOMY | 22-112 | 8.5" | \$9.95/ea |
| GERMAN | 22-111 | 8.5" | \$28.00/ea |
| INTEGRA/MILTEX | MIL11-122 | 8.5" | \$94.71/ea |



Weitlaner Retractor

| Vendor | Item# | Details | Price |
|------------------|-----------|--|------------|
| ECONOMY | 12-1460 | 5.5" | \$30.00/ea |
| JORGENSEN | JOR241E | 18cm (7"), Economy | \$39.00/ea |
| | JOR241 | 18cm (7"), Stainless Steel, Blunt hooked retractor, German-made. | \$96.00/ea |
| MID GRADE | 12-1460-S | 5.5", Satin Finish | \$33.00/ea |
| GERMAN | 21-316 | 5.5" 3x4 Sharp | \$55.00/ea |
| | 21-316B | 5.5" 3x4 Blunt German | \$55.00/ea |
| | 21-317 | 6" 3x4 Blunt | \$58.00/ea |



Super Mini Weitlaner Retractor

Stainless steel. Blunt hooked retractor. German-made.

| Vendor | Item# | Details | Price |
|------------------|----------|-------------------|------------|
| JORGENSEN | JOR241MA | 18cm (7"), 3 5/8" | \$61.00/ea |

Jorvet Cerclage Wire Passer

This is a simple instrument for passage of cerclage wire around fracture sites. Stainless steel. 15cm.

- Minimizes trauma to surrounding tissue
- Saves surgical time
- Double-ended for a whole range of bone sizes



| Vendor | Item# | Price |
|------------------|--------|------------|
| JORGENSEN | JOR217 | \$42.00/ea |

Jorvet Curved Graft Passer

| Vendor | Item# | Details | Price |
|------------------|----------|---------------------------------|-------------|
| JORGENSEN | JOR236 | Large, 4.5cm dia. head, 17cm L. | \$101.00/ea |
| | JOR236S | Small, 3.0cm dia. head, 15cm L. | \$95.00/ea |
| | JOR236L | X-Large, 6.0cm dia. head | \$101.00/ea |
| | JOR236XS | X-Small, 2.0cm dia. head. | \$106.00/ea |
| | JOR236XL | XX-Large, 8.0cm dia. head | \$109.00/ea |



Jorvet Cerclage Wire

| Vendor | Item# | Details | Price |
|------------------|---------|-----------|------------|
| JORGENSEN | JOR260A | 18g x 10m | \$10.20/ea |
| | JOR260B | 20g x 10m | \$10.20/ea |
| | JOR260C | 22g x 10m | \$10.20/ea |
| | JOR260D | 24g x 10m | \$10.20/ea |
| | JOR260E | 26g, 10m | \$10.20/ea |
| | JOR260F | 28g, 10m | \$10.20/ea |



Cerclage Wire Tightener

| Vendor | Item# | Details | Price |
|------------------|---------|---------|-------------|
| JORGENSEN | JOR218L | 5"L | \$175.00/ea |



Cerclage Wire Eyelet

| Vendor | Item# | Details | Price |
|------------------|----------|-------------|------------|
| JORGENSEN | JOR260AL | 18g, 6 pack | \$15.00/pk |
| | JOR260BL | 20g, 6 pack | \$15.00/pk |



Cerclage Wire Button

| Vendor | Item# | Details | Price |
|------------------|---------|-----------------------|------------|
| JORGENSEN | JOR260X | Fits 3.5mm DCP holes. | \$29.00/ea |



Double Loop Cerclage Wire Tightener

| Vendor | Item# | Price |
|------------------|----------|-------------|
| JORGENSEN | JOR218LD | \$140.00/ea |



Meniscus Knife

| Vendor | Item# | Details | Price |
|------------------|---------|---------|-------------|
| JORGENSEN | JOR236M | 15cm | \$102.00/ea |



Instruments

Orthopedic & OB - Wire Products



Gigli Saw Handles

| Vendor | Item# | Details | Price |
|-----------------------|-----------|-----------|-------------|
| GERMAN | 13-213 | Handles | \$24.00/ea |
| INTEGRA/MILTEX | MIL26-119 | Handles | \$121.34/ea |
| JORGENSEN | JOR107H | Wire Only | \$10.50/ea |



Gigli Wire

| Vendor | Item# | Details | Price |
|------------------|-----------|------------------|------------|
| GERMAN | 33-180 | 12" | \$7.50/ea |
| | 33-182 | 20" | \$7.50/ea |
| | MIL26-130 | 12" | \$10.88/ea |
| | MIL26-132 | 20" | \$10.88/ea |
| JORGENSEN | JOR107 | 52 cm. Wire Only | \$9.00/ea |



Gigli Saw Set

| Vendor | Item# | Details | Price |
|---------------|-----------|---|------------|
| GERMAN | GIGLI-GER | Includes 2 gigli handles and a 12" & 20" saw wire | \$35.00/ea |



Modified Gigli Bone Saw

Locking clip holds wire in proper position.

| Vendor | Item# | Price |
|------------------|---------|-----------|
| JORGENSEN | JOR107M | \$9.00/ea |

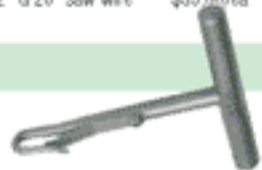

K-Wire Bender

| Vendor | Item# | Details | Price |
|------------------|--------|---------|------------|
| JORGENSEN | JOR211 | Bender | \$66.00/ea |

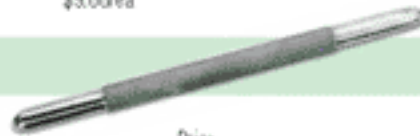

K-Wire Cutter

| Vendor | Item# | Details | Price |
|------------------|----------|--|-------------|
| GERMAN | V-400 | Tc Jaw, 9" | \$199.00/ea |
| JORGENSEN | JOR220BA | 8.5" | \$210.00/ea |
| | JOR220BB | Tungsten Carbide Inserts, Cuts wire up to 2.2mm. 9" | \$210.00/ea |
| | JOR49C | Wire Cutter with notched cutout. Stainless steel. Also useful for cutting suture wire. | \$195.00/ea |

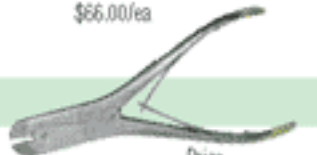

K-Wire Extraction Forceps

| Vendor | Item# | Details | Price |
|------------------|---------|---------|------------|
| JORGENSEN | JOR2110 | 5 1/2" | \$77.00/ea |



K-wire Storage Dispenser

| Vendor | Item# | Details | Price |
|------------------|---------|------------------------------|------------|
| JORGENSEN | JOR2500 | Stainless Steel, Autofodable | \$71.00/ea |



Jorvet K-wire/Small Pin Punch Smaller

| Vendor | Item# | Details | Price |
|------------------|---------|------------------------|------------|
| JORGENSEN | JOR215A | Small. 1.6mm fine tip. | \$54.00/ea |

Jorvet



Hauptner OB wire

Jorvet

| Vendor | Item# | Details | Price |
|------------------|--------|-----------|------------|
| JORGENSEN | JOR18H | 10 meters | \$27.00/ea |

Lyss OB Handle

Jorvet

| Vendor | Item# | Details | Price |
|------------------|--------|----------------------|------------|
| JORGENSEN | JOR21L | Stainless Steel, 3"L | \$13.80/ea |

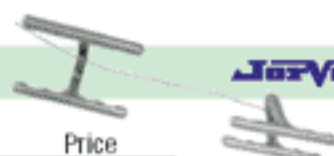

Jorvet Ob Saw Wire

| Vendor | Item# | Details | Price |
|------------------|-------|----------|------------|
| JORGENSEN | JOR18 | 11 yards | \$15.00/ea |

Jorvet



Jorvet Ob Saw Set

| Vendor | Item# | Details | Price |
|-----------------------|-----------|---|-------------|
| JORGENSEN | OB-1 | Includes one handle and 11 yds of wire saw. | \$21.00/ea |
| INTEGRA/MILTEX | GIGLI-MIL | Includes one handle and 11 yds of saw wire | \$100.00/ea |



Jorvet Ob Wire Handle

Jorvet

Sold Individually
this is not a pair

JOR21S



JOR21H



| Vendor | Item# | Details | Price |
|------------------|--------|--|------------|
| JORGENSEN | JOR21H | 3.5" long One Handle | \$12.00/ea |
| | JOR21S | Knurled no slip grip, 4" long One Handle | \$16.50/ea |

Jorvet OB Drop Wire Guide

Jorvet

This is an excellent guide, as it is heavy enough and shaped to permit easier passage around the fetal part. Stainless Steel. 3 1/2"L.

| Vendor | Item# | Details | Price |
|------------------|--------|--------------------------|-----------|
| JORGENSEN | JOR210 | Stainless Steel. 3 1/2"L | \$7.50/ea |



Jorvet OB Wire Guide

Jorvet

Wire is pushed into the end of the guide and fastened. The weighted ball end drops easily over the animal.

| Vendor | Item# | Details | Price |
|------------------|--------|---------------|------------|
| JORGENSEN | JOR20H | Hauptner, 7"L | \$51.00/ea |



13822 WEST BOULTON BLVD. METTAWA, IL 60045

Phone 800-544-7521

99

WWW.SHOPMEDVET.COM

Fax 800-204-2177

Orthopedic & OB - Wire Products

Jorvet OB Chain

Plated, 45"

| Vendor | Item# | Details | Price |
|------------------|---------|----------------------|------------|
| JORGENSEN | JOR24WH | Plated 45" | \$6.90/ea |
| | JOR24WS | Plated, 30" | \$6.30/ea |
| | JOR24WL | Plated, 60" | \$7.80/ea |
| | JOR24GS | Stainless Steel, 30" | \$49.50/ea |
| | JOR24GL | Stainless Steel, 60" | \$58.50/ea |



OB Chain Handles

Moore's OB Chain Handle. Stainless steel.

| Vendor | Item# | Details | Price |
|------------------|---------|---|-----------|
| JORGENSEN | JOR24W | Stainless Steel | \$9.00/ea |
| | JOR23S | Stainless Steel | \$7.50/ea |
| | JOR24WM | Stainless Steel w. plastic Laminate Handles | \$8.10/ea |



Jorvet T-bar OB handle

Allows for use of both hands for pulling. Handle 22cm L.

| Vendor | Item# | Price |
|------------------|--------|------------|
| JORGENSEN | JOR24T | \$23.25/ea |



Steel Stainless K-Wire

Highest quality stainless steel type 316LVM. U.S.A. made. Double Trocar Point.

| Vendor | Item# | Details | Price |
|------------------|----------|---------------------------------|-----------|
| JORGENSEN | JOR250PA | .062 x 7", double point, single | \$3.10/ea |
| | JOR250MA | .035 x 7" | \$3.10/ea |
| | JOR250NA | Single, .045 x 7" | \$3.00/ea |

Small Pin Vise



3 ft" L holds small K-wires and pins up to 2.5mm (3/32")

| Vendor | Item# | Details | Price |
|------------------|---------|--|------------|
| JORGENSEN | JOR214K | 3 ft" L holds small K-wires and pins up to 2.5mm (3/32") | \$78.00/ea |

Swedish OB Wire Handle and Wire Container



Serves both as a handle and also as a handy dispenser.

| Vendor | Item# | Details | Price |
|------------------|-------|--|------------|
| JORGENSEN | JOR21 | Serves both as a handle and also as a handy dispenser. | \$39.00/ea |



Wire Twister/Shear Cutter

| Vendor | Item# | Details | Price |
|------------------|--------|---------|------------|
| JORGENSEN | JOR218 | 15cm | \$93.00/ea |



Wire Twister

| Vendor | Item# | Details | Price |
|------------------|---------|---------|------------|
| JORGENSEN | JOR215L | 7" long | \$63.00/ea |



Wire Twister/Cutter

| Vendor | Item# | Details | Price |
|---------------|--------|----------------|------------|
| GERMAN | 33-195 | Twister/Cutter | \$70.00/ea |



Wire Passer

| Vendor | Item# | Details | Price |
|------------------|--------|---------------------------|-------------|
| GERMAN | V-100 | 15cm | \$13.00/ea |
| JORGENSEN | JOR221 | 3 sizes of hollow needles | \$148.00/ea |



Ophthalmic Surgery Pack

Kit contains the specialized instruments necessary to complete the more common eye surgical procedures. Just wrap with drape.

| Vendor | Item# | Details | Price |
|------------------|---------|--|-------------|
| JORGENSEN | JOR664 | Kit Includes: JOR232 Castroviejo, JOR68D Chalazion Forceps, JOR68GW Eye Lid Retractor, JOR231 Castroviejo Needle Holders, JORS1WC Iris Scissors, JOR55GA #3 Scalpel Handle. Tray Not Included. | \$230.00/ea |
| | JOR664K | Kit Includes: JOR232 Castroviejo, JOR68D Chalazion Forceps, JOR68GW Eye Lid Retractor, JOR231 Castroviejo Needle Holders, JORS1WC Iris Scissors, JOR55GA #3 Scalpel Handle, JOR664T Autoclave Tray (w. rubber mat) | \$299.00/ea |

Jorvet Farrowing Snare

| Vendor | Item# | Price |
|------------------|--------|------------|
| JORGENSEN | JOR22F | \$42.00/ea |

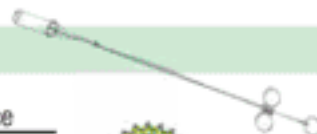

Behney Ear Instrument

Helps to avoid the problems associated with external bracing of cropped ears. Also very effective for getting problem ears to stand. Detailed literature and pictures available on request. Instrument consists of trocar, push rod, cannula, and wire implants. Two of each size.

| Vendor | Item# | Details | Price |
|------------------|--------|-----------------|------------|
| JORGENSEN | JOR49B | Stainless Steel | \$81.00/ea |



Instruments

OB & Orthopedic

Jorvet Balling Gun

| Vendor | Item# | Details | Price |
|------------------|---------|----------------------------|------------|
| JORGENSEN | JOR185S | 1-1/2" Head, 5/8" Diameter | \$15.00/ea |
| | JOR185 | 2 3/8" Head, 1" Diameter | \$20.10/ea |
| | JOR185P | 2-1/2" Head, 7/8" Diameter | \$30.00/ea |

Jorvet Bone Saw

| Vendor | Item# | Details | Price |
|------------------|----------|--|-------------|
| JORGENSEN | JOR219 | With 5 Blades | \$104.00/ea |
| | JOR219D1 | 5 pack Replacement Blades 15cm-19cm (5 1/2 x 7 1/2) | \$30.00/ea |

Hard-back Orthopedic Saw

| Vendor | Item# | Details | Price |
|------------------|---------|---|------------|
| JORGENSEN | JOR219X | 140mm long x 23mm deep with 0.4mm cut. | \$31.00/ea |

Bone Tunnel Borer

| Vendor | Item# | Details | Price |
|------------------|----------|----------------|-------------|
| JORGENSEN | JOR236T | 2.7mm | \$81.00/ea |
| | JOR236TC | w/Counter Sink | \$102.00/ea |

Cable Swine Snare

| Vendor | Item# | Details | Price |
|------------------|--------|-----------------------|------------|
| JORGENSEN | JOR22C | Swine Cable OB Snare. | \$49.50/ea |

Cast Spreader

| Vendor | Item# | Details | Price |
|-----------------------|------------|---------|-------------|
| GERMAN | V-265 | 12" | \$180.00/ea |
| INTEGRA/MILTEX | MIL27-3090 | 12" | \$264.12/ea |

Cast Cutter

| Vendor | Item# | Details | Price |
|---------------|------------|---------|-------------|
| GERMAN | V-260 | 5.75" | \$42.00/ea |
| MILTEX | MIL27-3020 | 5.75" | \$161.31/ea |

Heavy duty bandage/Cast Cutter

| Vendor | Item# | Details | Price |
|------------------|---------|---------|------------|
| JORGENSEN | JOR74HB | 8 1/2" | \$51.00/ea |

Jorvet Castroviejo Caliper

| Vendor | Item# | Details | Price |
|------------------|---------|-------------------------------|-------------|
| JORGENSEN | JOR232C | German-made. Stainless steel. | \$210.00/ea |

OB Calving Strap

High-quality tubular nylon strap with "D" ring. This strap is less traumatic to the unborn calf than steel chains. Royal blue. 1"W.

| Vendor | Item# | Details | Price |
|------------------|---------|--|-----------|
| JORGENSEN | JOR24XS | High quality tubular nylon strap with "D" ring, 1"W, 30" | \$5.10/ea |
| | JOR24XL | High quality tubular nylon strap with "D" ring, 1"W, 60" | \$6.75/ea |

Dome Catheter

| Vendor | Item# | Details | Price |
|-----------------------|----------|--------------------------|------------|
| INTEGRA/MILTEX | MIL3-944 | 15-13/16"x3-1/32"x29/32" | \$22.08/ea |

Embryotomy Knife

| Vendor | Item# | Details | Price |
|------------------|-------|-------------------|------------|
| JORGENSEN | JOR17 | Gunther, 2 1/2"L. | \$31.50/ea |

Emmett Uterine Tenaculum Hook

| Vendor | Item# | Details | Price |
|-----------------------|-----------|---|------------|
| INTEGRA/MILTEX | MIL30-951 | 9" (22.9 cm), style 1, half-curved, small | \$77.95/ea |

Femoral Disarticulator

| Vendor | Item# | Details | Price |
|------------------|---------|-------------|------------|
| JORGENSEN | JOR233 | Small 5.5" | \$66.00/ea |
| | JOR233B | Large 7.75" | \$96.00/ea |

Feline/Canine Gags

| Feline | | Item# | Details | Price |
|------------------|--|----------|-----------------------|------------|
| JORGENSEN | | JOR51F | Stainless Steel, 3" | \$9.90/ea |
| | | JOR51FD1 | Inserts, Pair, Feline | \$3.30/ea |
| Canine | | | | |
| JORGENSEN | | JOR51C | Large, 6 3/4" | \$12.90/ea |
| | | JOR51A | Small, 4 1/2" | \$12.90/ea |
| | | JOR51B | Medium, 5" | \$12.90/ea |
| | | JOR51D1 | Inserts, Pair, Canine | \$3.30/ea |

Smith-Baxter Mouth Gag

| Vendor | Item# | Details | Price |
|------------------|----------|----------|------------|
| JORGENSEN | JOR51SBC | Large | \$18.00/ea |
| | JOR51SBB | Medium | \$15.00/ea |
| | JOR51SBS | Set of 4 | \$66.00/ea |
| | JOR51SBA | Small | \$15.00/ea |
| | JOR51SBD | X-large | \$21.00/ea |

Instruments

OB & Orthopedic

Graefe's Eye Speculum



| Vendor | Item# | Details | Price |
|------------------|--------|-------------------|------------|
| JORGENSEN | JOR68G | for small animals | \$15.00/ea |

Graft Passer with Small Eye



| Vendor | Item# | Details | Price |
|------------------|----------|-----------------------|------------|
| JORGENSEN | JOR236SE | 6"L., Stainless Steel | \$95.00/ea |

Graves Vaginal Speculum



| Vendor | Item# | Details | Price |
|----------------|--------|---------|-----------|
| ECONOMY | 10-271 | Medium | \$6.95/ea |

Grooved Probe Director



| Vendor | Item# | Details | Price |
|------------------|--------|---------------------|-----------|
| JORGENSEN | JOR92P | Stainless steel, 5" | \$4.50/ea |

Jorvet

Gerzog Bone Mallet



| Vendor | Item# | Details | Price |
|-----------------------|-----------|--|-------------|
| GERMAN | 21-277 | 7.5", 8oz head | \$62.00/ea |
| INTEGRA/MILTEX | MIL19-790 | 7.5", 8oz head | \$124.89/ea |
| JORGENSEN | JOR228M | 18cm (7 1/4"), German-made, Stainless steel. | \$54.00/ea |

Mead Mallet



With hardened nylon face. Replaceable 26mm dia. mallet face. Weighs 320gm. 6 3/4" (17cm) L.

| Vendor | Item# | Details | Price |
|------------------|---------|---|------------|
| JORGENSEN | JOR228X | With hardened nylon face. Replaceable 26mm dia. mallet face. Weighs 320gm. 6 3/4" (17cm) L. | \$79.00/ea |

| Vendor | Item# | Details | Price |
|---------------|--------|-----------------------|------------|
| GERMAN | 33-360 | Stainless Steel, 7.5" | \$82.00/ea |

Mead Mallet (Spare Face)

| Vendor | Item# | Details | Price |
|------------------|-----------|------------|------------|
| JORGENSEN | JOR228XD1 | Spare Face | \$15.00/ea |

Percussion Mallet



| Vendor | Item# | Details | Price |
|------------------|---------|--------------------------|-----------|
| JORGENSEN | JOR894E | Economy, Stainless Steel | \$6.00/ea |

Nasal Speculum **Jorvet**



| Vendor | Item# | Details | Price |
|------------------|-----------|--------------------|------------|
| ECONOMY | 10-1080 | Child 5.5" | \$9.00/ea |
| | 10-1085 | Adult | \$9.00/ea |
| MID GRADE | 10-1085-S | 5.5", Satin Finish | \$12.00/ea |
| | 10-1080-S | 5.5", Satin Finish | \$12.00/ea |
| GERMAN | 21-240 | Infant | \$18.00/ea |
| | 21-242 | Small | \$18.00/ea |
| | 21-244 | Medium | \$18.00/ea |

Orthopedic Distractor

Jorvet



Can be used with ESF Pins 3.2-4.0mm. Distractors are useful instruments for the proper repositioning and compression of long bone fractures. The distractor will hold the bone in anatomical alignment and allow the placement of either bone plates, K-E external fixation devices, or bone screws. The instrument will greatly reduce the amount of manipulation that goes on when trying to maintain alignment during surgery, and allows the surgeons to concentrate their efforts on applying the proper fixation device.

| Vendor | Item# | Details | Price |
|------------------|--------|-----------------------------|-------------|
| JORGENSEN | JOR237 | use with ESF Pins 3.2-4.0mm | \$610.00/ea |

Reduction Forceps with Spinlock



Spin lock. Provides incremental secure control, round ends.

| Vendor | Item# | Details | Price |
|------------------|----------|----------------------|-------------|
| JORGENSEN | JOR212GS | Standard, 6" (15cm). | \$104.00/ea |

Rib Cutter/Shearer

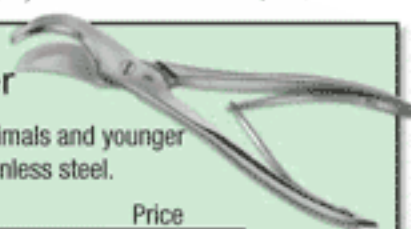

Cuts through rib cage on small animals and younger large animals. German-made. Stainless steel.

| Vendor | Item# | Details | Price |
|------------------|--------|-----------|-------------|
| JORGENSEN | JOR508 | 9" length | \$118.00/ea |

Finochietto Rib Spreader

| Vendor | Item# | Details | Price |
|------------------|---------|---|-------------|
| JORGENSEN | JOR2420 | 8" (20.3cm) spread, 65mm W x 48mm D blades. | \$506.00/ea |

Mini Finchietto Rib spreader

| Vendor | Item# | Details | Price |
|------------------|----------|---|-------------|
| JORGENSEN | JOR2420M | 3" (75mm) spread, 20mm W x 18mm D blades. | \$245.00/ea |

OB & Orthopedic



Strawberry Roaring Burr



| Vendor | Item# | Details | Price |
|------------------|---------|----------------------|------------|
| JORGENSEN | JOR62ST | 8.5" Stainless Steel | \$27.00/ea |

Sharpening Steel



| Vendor | Item# | Details | Price |
|------------------|---------|------------------|------------|
| JORGENSEN | JOR902 | Sharpening stone | \$21.90/ea |
| | JOR902S | Sharpening stone | \$15.00/ea |

T-Bar Swine Snare



| Vendor | Item# | Details | Price |
|------------------|--------|---------------|------------|
| JORGENSEN | JOR22T | 10" L. shaft. | \$46.50/ea |

Tail Docker



| Vendor | Item# | Details | Price |
|------------------|--------|-------------|-------------|
| JORGENSEN | JOR176 | Tail Docker | \$101.00/ea |

Slocum/TPLO Rotation Gauge



| Vendor | Item# | Details | Price |
|------------------|---------|----------------|-------------|
| JORGENSEN | JOR822F | rotation gauge | \$101.00/ea |

Taylor Hammer



| Vendor | Item# | Details | Price |
|------------------|---------|--------------|------------|
| ECONOMY | 11-1275 | Chrome, 7.5" | \$3.95/ea |
| JORGENSEN | JOR894 | | \$14.10/ea |

Umbilical Tape



| Vendor | Item# | Details | Price |
|------------------|---------|----------------------------|-----------|
| JORGENSEN | JOR25UC | Non-Sterile, 1/4" X 20 yds | \$6.10/ea |

Jorvet Umbilical Clamps



| Vendor | Item# | Details | Price |
|------------------|--------|--|------------|
| JORGENSEN | JOR56B | Non-Sterile | \$17.60/ea |
| | JOR56 | Sterile Umbilical Clamp helps prevent navel infection. Self-locking, disposable plastic. Single. | \$0.96/ea |

Umbilical Huston Hernia Clamp

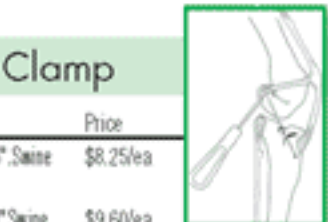

| Vendor | Item# | Details | Price |
|------------------|---------|--|-----------|
| JORGENSEN | JOR56HA | Huston Hernia Clamp, 5" Swine Hernia Clamp, 5" | \$8.25/ea |
| JORGENSEN | JOR56HB | Huston Hernia Clamp, 7" Swine Hernia Clamp, 7" | \$9.60/ea |

Jorvet Trocar-Trocar I. M. Pins

Highest quality type 316L stainless steel IM pins. Available in the points and diameters listed below. When ordering, please match diameter with point style number. Made in U.S.A.

| Vendor | Item# | Details | Price |
|------------------|---------|-------------|-----------|
| JORGENSEN | JOR250E | 1/8" x 9" | \$9.00/ea |
| | | 3/32" x 8" | \$6.90/ea |
| | | 5/32" x 10" | \$7.95/ea |
| | | 5/64" x 7" | \$4.65/ea |
| | | 7/64" x 8" | \$9.00/ea |
| | | 9/64" x 9" | \$5.25/ea |



Check our Orthopedic Section for a Full line of Pins and Plates

Pin Removal Forceps

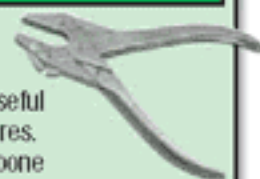

Pin removal is made easy with this forceps. Also useful for bending, holding, and cutting small pins and wires. Parallel action pliers may be used in tandem with bone plate bender for contouring smaller plates.

| Vendor | Item# | Details | Price |
|------------------|--------|--------------------------------|-------------|
| JORGENSEN | JOR442 | Stainless Steel, w/Wire Cutter | \$246.00/ea |

Enclosed Bone Pin Cutter



| Vendor | Item# | Details | Price |
|------------------|---------|-------------------|-------------|
| JORGENSEN | JOR220P | up to 4mm (5/32") | \$224.00/ea |

Pincutter with Breakdown Handle

Large pin cutter similar to JOR220 only handles detach to fit into smaller autoclaves. From 490mm (19 3/8") to 260mm (10 3/8"). Gold colored handles with tungsten carbide inserts.

| Vendor | Item# | Price |
|------------------|---------|-------------|
| JORGENSEN | JOR220Q | \$340.00/ea |

Pin Cutter

| Vendor | Item# | Details | Price |
|---------------|-------|---------|-------------|
| GERMAN | V-105 | 19" | \$249.00/ea |

Jorvet Bone Pin Counter Punch

| Vendor | Item# | Price |
|------------------|--------|------------|
| JORGENSEN | JOR215 | \$52.00/ea |

Small Lowman Bone Clamp

Developed from standard human Lowman clamp. This clamp grips bone up to 15mm diameter and will also hold small plates in position.

| Vendor | Item# | Details | Price |
|------------------|---------|-------------------|-------------|
| JORGENSEN | JOR213Q | 3" (70mm) length. | \$120.00/ea |

Instruments

OB & Orthopedic/Biopsy Instruments/Hoof Care



Jorvet Hoof Knife



| Vendor | Item# | Details | Price |
|------------------|-----------|------------------------------------|------------|
| JORGENSEN | JOR32HLE | Left, Economy, Ebony | \$9.75/ea |
| | JOR32HRE | Right, Economy, Ebony | \$9.75/ea |
| | JOR34CLE | 5/8" W x 2 1/2" L., Left, Economy | \$9.00/ea |
| | JOR34CRE | 5/8" W x 2 1/2" L., Right, Economy | \$9.00/ea |
| | JOR34CN | 3/8" blade (left or right) | \$19.50/ea |
| | JOR34CNLE | 3/8", Left, Economy | \$9.00/ea |
| | JOR34CNRE | 3/8", Right, Economy | \$9.00/ea |
| | JOR34K | Left or Right | \$15.00/ea |



Left Curved Hoof Knife



| Vendor | Item# | Details | Price |
|------------------|----------|---|------------|
| JORGENSEN | JOR32HWL | Wood Handle, Left, Curved, Blade 5/8" W x 2 3/4" L. | \$30.90/ea |

Jorvet Hoof Knife Set



| Vendor | Item# | Details | Price |
|------------------|----------|---------|------------|
| JORGENSEN | JOR32HSE | Economy | \$60.00/ea |

Jorvet Oval Hoof Knife



| Vendor | Item# | Price |
|------------------|--------|------------|
| JORGENSEN | JOR340 | \$38.00/ea |



Jorvet Hoof Knife Hone



| Vendor | Item# | Price |
|------------------|--------|------------|
| JORGENSEN | JOR33H | \$12.60/ea |

Swiss Knife



| Vendor | Item# | Details | Price |
|------------------|--------|---------|------------|
| JORGENSEN | JOR32E | 7.25" | \$27.50/ea |

Hughes hoof groover



| Vendor | Item# | Details | Price |
|------------------|---------|------------------|------------|
| JORGENSEN | JOR32HG | 6 1/4" (16cm) L. | \$18.00/ea |

Hoof Blade



| Vendor | Item# | Details | Price |
|------------------|--------|----------------|-----------|
| JORGENSEN | JOR34S | 2.5" Blade, 6" | \$9.00/ea |

Clinch Cutter



| Vendor | Item# | Details | Price |
|------------------|----------|---------|------------|
| JORGENSEN | JOR1024C | 6" | \$21.00/ea |

Hoof Pick



| Vendor | Item# | Details | Price |
|------------------|--------|---------|-----------|
| JORGENSEN | JOR32P | each | \$1.80/ea |

Hoof Crease Nail Puller



| Vendor | Item# | Price |
|------------------|---------|------------|
| JORGENSEN | JOR1024 | \$39.00/ea |

Small Loop Abscess Knife



| Vendor | Item# | Price |
|------------------|--------|------------|
| JORGENSEN | JOR34L | \$45.00/ea |

Jorvet Lichy Knife



| Vendor | Item# | Details | Price |
|------------------|--------|----------------------|------------|
| JORGENSEN | JOR9LS | 5.5" Stainless Steel | \$15.00/ea |

Danish Knife



| Vendor | Item# | Details | Price |
|------------------|-------|--------------------------------|------------|
| JORGENSEN | JOR5 | 4.5" Handle, 2.5", Probe Point | \$13.50/ea |

Jorvet Teat Blade



| Vendor | Item# | Details | Price |
|------------------|-------|-----------------|------------|
| JORGENSEN | JOR8 | 7.5" Thin Model | \$51.00/ea |

Hug's Blade



| Vendor | Item# | Details | Price |
|------------------|-------|----------------------|------------|
| JORGENSEN | JOR4 | .5" Blade, 6" Handle | \$33.00/ea |

Surgical Drill & Accessories & Rodent Instruments



Makita Orthopedic Drill

Variable-speed 0-600 RPM vs. Standard model which has 100 or 200 RPM settings. Do not autoclave.

| Vendor | Item# | Details | Price |
|------------------|----------|------------|-------------|
| JORGENSEN | JOR238PD | Drill Only | \$180.00/ea |

Jorvet



JOR238PD



JOR238SD

Drill Shroud (Autoclavable)

| Vendor | Item# | Details | Price |
|------------------|----------|-----------------------------------|------------|
| JORGENSEN | JOR238SD | Disposable, Sterile, 5/pk. | \$11.10/pk |
| | JOR238S | Will fit any standard size drill. | \$13.35/ea |

Orthopedic Drill Adaptor

| Vendor | Item# | Details | Price |
|------------------|---------|-----------|------------|
| JORGENSEN | JOR238T | Dr. Joe's | \$33.00/ea |

Jorvet



Small Pin/Tap Chuck

for 2mm taps 4" length

| Vendor | Item# | Details | Price |
|------------------|---------|------------------------|-------------|
| JORGENSEN | JOR214S | for 2mm taps 4" length | \$111.00/ea |

Jorvet



Jacobs Pin Chuck

| Vendor | Item# | Details | Price |
|------------------|-----------|-------------------|-------------|
| JORGENSEN | JOR214LD1 | Short chuck & key | \$112.00/ea |

Small Jacobs Chuck

Lightweight blue anodized aluminum. 120g. 14cm.

- Much finer, more delicate, and less than half the weight of standard chucks
- Ideal for small dogs and cats when using "k" wires and small pins up to 5/32"
- Handle not slotted as JOR214L

| Vendor | Item# | Details | Price |
|------------------|--------|------------|-------------|
| JORGENSEN | JOR214 | 120g. 14cm | \$188.00/dz |

Jorvet-Aesculap Saw Blades

| Vendor | Item# | Details | Price |
|------------------|------------|-------------|-------------|
| JORGENSEN | JOR238SB24 | Radius 24mm | \$445.00/ea |
| | JOR238SB30 | Radius 30mm | \$445.00/ea |

Jorvet



Jorvet Rodent Molar Cutter

Jorvet

| Vendor | Item# | Price |
|------------------|---------|-------------|
| JORGENSEN | JOR51RM | \$105.00/ea |



Rodent Mouth Gag

Jorvet

Examination of the rabbit mouth is virtually impossible without a gag of this type.

| Vendor | Item# | Price |
|------------------|---------|------------|
| JORGENSEN | JOR51RG | \$75.00/ea |



Lightweight Rodent Mouth Gag

| Vendor | Item# | Price |
|------------------|----------|------------|
| JORGENSEN | JOR51RGS | \$60.00/ea |

Jorvet

Nazzy Ferret Mouth Gag

A smaller version of the feline gag. This works very well on ferrets, kittens, and small puppies.

| Vendor | Item# | Details | Price |
|------------------|--------|---------|------------|
| JORGENSEN | JOR51G | 1 1/8" | \$35.00/ea |



Rodent Tooth Rasp

Molar Rasp (rabbits). Unsuitable for debulking but good for removal of small spurs.

| Vendor | Item# | Price |
|------------------|---------|------------|
| JORGENSEN | JOR51RR | \$60.00/ea |



Rodent Cheek Dilator

The cheek dilator allows visualization of molars and protects cheeks from instruments.

| Vendor | Item# | Details | Price |
|------------------|-----------|-----------------------|------------|
| JORGENSEN | JOR51RDL | Large | \$21.00/ea |
| | JOR51RDLX | Large with long reach | \$21.00/ea |



Jorvet Rodent Dental Spatula

Jorvet

Used to deflect tongue and cheeks to enable best possible view of problems.

| Vendor | Item# | Price |
|------------------|---------|------------|
| JORGENSEN | JOR51RS | \$24.00/ea |



Biopsy Products/Castration Products

Inexpensive Disposable Skin Biopsy Punch

| Vendor | Item# | Details | Price |
|------------------|----------|-----------|------------|
| JORGENSEN | JOR163D4 | 4mm, 5pk. | \$16.20/pk |
| | JOR163D6 | 6mm, 5pk. | \$16.20/pk |
| | JOR163D8 | 8mm, 5pk. | \$16.50/pk |

Keyes Biopsy Punch

Original round skin punches, knurled handle. Stainless steel. German-made. 4 1/2" (12cm).

| Vendor | Item# | Details | Price |
|------------------|---------|---|------------|
| JORGENSEN | JOR163B | 8mm head | \$30.00/ea |
| | JOR163 | Stainless Steel, German-made, 4 1/2" (12cm), 4mm head | \$27.75/ea |
| | JOR163A | Stainless Steel, German-made, 4 1/2" (12cm), 6mm head | \$27.00/ea |

Jackson-Chevalier Biopsy Forcep

| Vendor | Item# | Details | Price |
|------------------|----------|---------|------------|
| JORGENSEN | JOR116JC | | \$48.00/ea |

Uterine Biopsy Forcep

This is the instrument of choice for equine uterine biopsy. Cutting area is 4mm x 28mm. Stainless steel.

| Vendor | Item# | Details | Price |
|------------------|----------|-------------------------|-------------|
| JORGENSEN | JOR116JW | Shaft 60cm (23 1/2" L). | \$402.00/ea |

Soft Tissue Biopsy Alligator Forceps

| Vendor | Item# | Details | Price |
|------------------|--------|---|-------------|
| JORGENSEN | JOR117 | 2mm diameter, shaft is 10cm. Biopsy jaws 2 mm x 3.6 mm. | \$165.00/ea |

Equine Uterine Biopsy Instrument

This biopsy instrument will separate into two parts allowing it to fit into the autoclave. Total length - 63cm (25") 3 finger ring configuration

| Vendor | Item# | Price |
|------------------|---------|------------|
| JORGENSEN | JOR116U | \$82.00/ea |

Van Buren Urethral Sound

| Vendor | Item# | Details | Price |
|-----------------------|------------|------------------------------|------------|
| INTEGRA/MILTEX | MIL29-6-24 | 11" (27.9 cm), 24 Fr. (8 mm) | \$80.02/ea |

Killian Speculum

| Vendor | Item# | Price |
|------------------|--------|------------|
| JORGENSEN | JOR52K | \$18.00/ea |

Jorvet Polansky Speculum

| Vendor | Item# | Price |
|------------------|--------|------------|
| JORGENSEN | JOR52P | \$90.00/ea |

Franks Emasculator

| Vendor | Item# | Details | Price |
|------------------|---------|----------------------|------------|
| JORGENSEN | JOR36FS | 7.5" Stainless Steel | \$90.00/ea |

White's Modified Emasculator

| Item# | Details | Price |
|--------|-----------------------|------------|
| JOR36P | Stainless steel, 12". | \$116.00ea |

Standard Emasculator

Hausman Standard Emasculator.

| Item# | Details | Price |
|--------|-----------------------|------------|
| JOR36P | Stainless steel, 12". | \$116.00ea |

Small Emasculator

Small Emasculator. Stainless steel, 7 1/2".

| Item# | Details | Price |
|--------|---------|------------|
| JOR36S | 7 1/2" | \$81.00/ea |

Sands Castrator

| Vendor | Item# | Details | Price |
|------------------|--------|---------------------|-------------|
| JORGENSEN | JOR36G | 12" Stainless Steel | \$159.00/ea |

Reimer Emasculator Stainless Steel German

| Vendor | Item# | Details | Price |
|------------------|-------|------------------------------|-------------|
| JORGENSEN | JOR37 | Stainless Steel 12 1/2" Long | \$410.00/ea |

Spay Packs



CANINE SPAY PACK

The Canine Spay Pack includes 18 stainless steel instruments. Available in three grades: Economy, Hi-Tech and Miltex.

- 1 Mayo Scissors 6 3/4" straight
- 1 #3 Scalpel/Blade Handle
- 1 Snook Hook 8"
- 2 Kelly Hemostat Forceps 5 1/2" curved
- 1 Metzenbaum Scissor, 5 1/2" curved
- 1 Tissue Forceps, 5 1/2", 1 x 2 teeth
- 4 Backhaus Towel Forceps 3 1/2"
- 1 Olsen-Hegar Needle Holder 6 1/2"
- 1 Adson-Brown Forceps 4 3/4" 7x7
- 1 Allis Forceps 6" 4x5
- 2 Halstead Mosquito Forceps, 5" curved
- 2 Rochester-Carmalt Forceps, 6.25" curved



HI-TECH

HIGHEST QUALITY
GERMAN SURGICAL
INSTRUMENTS

German
Instruments Only

| Vendor | Item# | Details | Price |
|--------------------------------------|------------|----------------|-------------|
| GERMAN WITH LIFETIME WARRANTY | CSPAY-GER | 18 Instruments | \$291.99/ea |
| ECONOMY | CSPAY-ECON | 18 Instruments | \$39.95/ea |
| INTEGRA/MILTEX | CSPAY-MIL | 18 instruments | \$799.00/ea |

FELINE SPAY PACK

The Feline Spay Pack includes 18 stainless steel instruments. Available in three grades: Economy, Hi-Tech and Miltex.

- 1 Mayo Scissors 6 3/4" straight
- 1 #3 Scalpel/Blade Handle
- 1 Snook Hook 8"
- 2 Kelly Hemostat Forceps 5 1/2" curved
- 1 Metzenbaum Scissor, 5 1/2" curved
- 1 Tissue Forceps, 5 1/2", 1 x 2 teeth
- 4 Backhaus Towel Forceps 3 1/2"
- 1 Olsen-Hegar Needle Holder 5 1/2"
- 1 Adson-Brown Forceps 4 3/4" 7x7
- 1 Allis Forceps 6" 4x5
- 2 Halstead Mosquito Forceps, 5" curved
- 2 Rochester-Carmalt Forceps, 6.25" curved



HI-TECH

HIGHEST QUALITY
GERMAN SURGICAL
INSTRUMENTS

German
Instruments Only

| Vendor | Item# | Details | Price |
|--------------------------------------|------------|----------------|-------------|
| GERMAN WITH LIFETIME WARRANTY | FSPAY-GER | 18 Instruments | \$291.99/ea |
| ECONOMY | FSPAY-ECON | 18 Instruments | \$39.95/ea |
| INTEGRA/MILTEX | FSPAY-MIL | 18 Instruments | \$799.00/ea |

Jorvet Tenotome



| Vendor | Item# | Price |
|------------------|---------|--|
| JORGENSEN | JOR88A | Small, Blunt and Curved, 15 x 3mm blade. \$9.90/ea |
| | JOR88BC | Blunt and curved, 5cm x 1/2cm blade. \$24.00/ea |
| | JOR88BS | Blunt and Straight, 5cm x 1/2cm blade. \$24.00/ea |
| | JOR88SC | Sharp and Curved, 5cm x 1/2cm blade. \$24.00/ea |

Jorvet Nano Paste Syringe



| Vendor | Item# | Price |
|------------------|---------|-------------|
| JORGENSEN | JOR338A | \$160.00/ea |

Instrument ID Roll Tape

| Vendor | Item# | Details | Price |
|----------------|---------|--------------------|--------------|
| MEDLINE | JOR832F | Fluorescent orange | \$15.94/roll |
| | JOR832G | Kelly Green | \$15.94/roll |
| | JOR832R | Red | \$15.94/roll |
| | JOR832B | Royal Blue | \$19.50/roll |
| | JOR832P | Purple | \$15.94/roll |



Instrument Color Code ID Ring

Assorted Package of 100

| Vendor | Item# | Price |
|------------------|---------|------------|
| JORGENSEN | JOR832X | \$18.00/ea |



Instrument/Mayo Trays, Emetics Basins, Dressing Jars, Sponge Bowls, Thermometer/Forceps Jars & More

CHECKOUT OUR EQUIPMENT SECTION THIS CATALOG



13822 WEST BOULTON BLVD. METTAWA, IL 60045

WWW.SHOPMEDVET.COM

Phone 800-544-7521

107

Fax 800-204-2177

Spay/Instrument Packs



Jorvet Spay/Neuter Surgery Pack

Complete surgery pack for routine spay and general surgery. Features a mix of German-made and/or economy instruments.

- Olsen Hegar Needle Holder. Tungsten carbide tip. German-made. 6 1/2"L (~16cm).
- Mayo Scissors. Straight. German-made. 5 1/2"L (~14cm).
- Instrument Tray. 10" x 6 3/4" x 2" (~25.4cm x 17cm x 5cm).
- Heavy-Duty Cloth Pack Wrap. 27" x 27" (~68.5cm x 68.5cm).
- Huck Towel. 17" x 33" (~43cm x 84cm).
- Brown Adson Forceps. German-made. 4 3/4" (~12cm).
- Scalpel Handle. #3 economy.
- Sponge Forceps. Economy. 8" (~20cm).
- Four Backhaus Towel Clamps. Economy. 5 1/2" (~14cm).
- Two Mosquito Forceps. Straight. Economy. 5" (~12.7cm).
- Two Kelly Forceps. Curved. Economy. 5 1/2" (~14cm).
- Snook Spay Hook. Economy. 8" (~20cm).
- Allis Tissue Forceps. Economy. 6" (~15cm).
- Spring Suture Needle Holder. German-made.
- Two Carmalt Forceps. CVD. Economy.



| Vendor | Item# | Price |
|------------------|--------|-------------|
| JORGENSEN | JOR432 | \$210.00/ea |

Surgical Instrument Guards

Jorvet instrument guards are designed to protect valuable instrument tips from damage during sterilization and handling. Sharp and pointed tips can break through sterilization pouches and injure the surgeon. 50/pkg. Non-sterile, but can be autoclaved or gas sterilized Medical-grade plastic (vented) Guards can also work as covers over exposed bone pins.

| Vendor | Item# | Details | Price |
|------------------|---------|--|------------|
| JORGENSEN | JOR926S | Assorted Set | \$18.00/ea |
| | JOR926J | Black, 1/8" x 1" x 1" (3.2mm x 25mm x 25mm) | \$14.70/ea |
| | JOR926B | Blue, 5/64" x 3/4" (2.0mm x 19mm) | \$14.70/ea |
| | JOR926H | Brown, 5/64" x 5/8" x 1" (2.0mm x 16mm x 25mm) | \$14.70/ea |
| | JOR926C | Green, 7/64" x 3/4" (2.8mm x 19mm) | \$14.70/ea |
| | JOR926F | Maroon, 13/32" x 3/4" (10.3mm x 19mm) | \$14.70/ea |
| | JOR926G | Orange, 1/16" x 3/8" x 1" (1.6mm x 9.5mm x 25mm) | \$14.70/ea |
| | JOR926D | Red, 1/8" x 1" (3.2mm x 25mm) | \$14.70/ea |
| | JOR926A | White, 1/16" x 3/4" (1.6mm x 19mm) | \$14.70/ea |
| | JOR926E | Yellow, 3/16" x 1" (4.8mm x 25mm) | \$14.70/ea |



7 Instrument Pack

General Instrument Pack- Seven Non-Sterile Includes:

- | | |
|---------------------|----------------------------|
| 1 Iris Forceps | 1 Thumb Tissue Forcep |
| 1 Iris Scissor | 1 Utility Bandage Scissors |
| 1 Mosquito Forcep | 1 Webster Needle Holder |
| 1 O.R. Scissor, S/B | |

| Vendor | Item# | Details | Price |
|----------------|-------|---------------|-----------|
| ECONOMY | GP7 | 7 Instruments | \$8.99/ea |

10 Instrument Pack

General Instrument Pack- Ten Non-Sterile Includes:

- | | |
|-----------------------------|----------------------------|
| 1 Adson Dressing Forceps | 1 Mosquito Forceps |
| 1 Baumgartner Needle Holder | 2 Thumb Dressing Forceps |
| 1 Derf Needle Holder | 1 Utility Bandage Scissors |
| 1 Iris Forceps | 1 Webster Needle Holder |
| 1 Iris Scissors | |

| Vendor | Item# | Details | Price |
|----------------|-------|----------------|-----------|
| ECONOMY | GP10 | 10 Instruments | \$9.99/ea |

14 Instrument Pack

The Economy Instrument Pack includes:

- | | |
|-----------------------------|----------------------------|
| 1 Adson Dressing Forceps | 1 Mosquito Forceps |
| 1 Allis Tissue Forceps | 1 OR Scissors |
| 1 Backhaus Towel Clamp | 1 Rochester-Pean Forceps |
| 1 Baumgartner Needle Holder | 1 Thumb Dressing Forceps |
| 1 Crile Forceps | 1 Utility Bandage Scissors |
| 1 Derf Needle Holder | 1 Webster Needle Holder |
| 1 Iris Forceps | |
| 1 Iris Scissors | |

| Vendor | Item# | Details | Price |
|----------------|--------|----------------|------------|
| ECONOMY | PACK14 | 14 Instruments | \$13.99/ea |

General Surgery Pack

The General Surgery Pack includes 19 stainless steel instruments.

Available in three grades: Economy, Hi-Tech and Miltex.

- | | |
|--|---|
| • 1 Mayo Scissors 6 3/4" straight | • 4 Rochester-Carmalt Forceps 6 1/4" crv. |
| • 1 Metzenbaum Scissor 7" curved | • 4 Backhaus Towel Forceps 3 1/2" |
| • 1 #3 Scalpel/Blade Handle | • 1 Olsen-Hegar Needle Holder 6 1/2" |
| • 3 Halstead Mosquito Forceps 5" curved | • 1 Adson-Brown Forceps 4 3/4" 7x7 |
| • 2 Kelly Hemostat Forceps 5 1/2" curved | • 1 Snook Hook |

| Vendor | Item# | Details | Price |
|-----------------------|------------|----------------|---------------|
| ECONOMY | GPACK-ECON | 19 Instruments | \$59.00/ea |
| GERMAN | GPACK-GER | 19 Instruments | \$249.00/ea |
| INTEGRA/MILTEX | GPACK-MIL | 19 Instruments | \$1,229.47/ea |

German Instrument Packs & Miscellaneous

German Knee Pack

General Knee Pack includes:

- 1 Hohmann Retractor
- 2 Mini-Hohmann Retractors
- 1 Gelpi Retractor 3 1/2"
- 1 Gelpi Retractor 5 1/2"
- 1 Senn Retractor, Sharp
- 1 Senn Retractor, Blunt
- 1 Rochester-Oschner Forcep

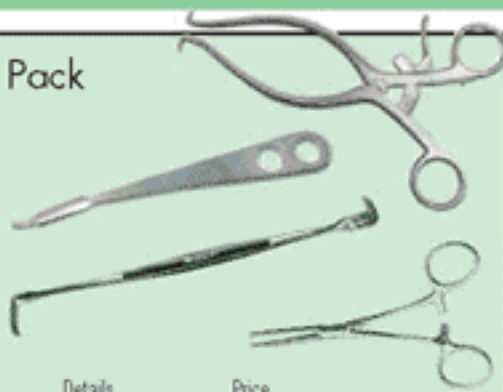

| Vendor | Item# | Details | Price |
|---------------|----------|---------------|-------------|
| GERMAN | KNEE-GER | 8 Instruments | \$279.99/ea |

German Osteotome Pack

General Osteotome Pack includes:

- 1 Mead Mallet 5" x 15mm
- 5 Lambotte Osteotomes:
 - 7" x 4mm
 - 5" x 4mm 7" x 10mm
 - 5" x 10mm



| Vendor | Item# | Details | Price |
|---------------|---------|-----------------------|-------------|
| GERMAN | Ost-GER | 6 Instruments, German | \$199.99/ea |

German Eye Pack

German Eye Pack includes:

- Defl Needle Holder
- Stevens Tenotomy Scissors
- Barraquer Eye Retractor
- Bishop-Harmon Forcep
- Sterilization Tray



| Vendor | Item# | Details | Price |
|---------------|---------|---------------|-------------|
| GERMAN | EYE-GER | 5 Instruments | \$119.99/ea |

German Orthopedic Pack

The German orthopedic pack comes complete with 14 German Hi-Tech stainless steel instruments.

- 1 Mead Mallet
- 1 Lambotte Osteotome, 5" x 10mm
- 1 Gigli Saw Handle (2 per set)
- 1 Gigli Wire Saw, 12"
- 1 Gigli Wire Saw, 20"
- 1 Oben-Hegar Needle Holder 5 1/2"
- 1 Senn Retractor, Sharp
- 1 Senn Retractor, Blunt
- 1 Retractor
- 1 Baby Kern Bone Folding Forcep
- 1 Kern Bone Holding Forcep
- 1 Roger Wire Cutting Scissors
- 1 Wire Twister/Shear Cutter
- 1 IM Pin Bag

| Vendor | Item# | Details | Price |
|---------------|----------|----------------|-------------|
| GERMAN | ORTH-GER | 14 Instruments | \$449.00/ea |



Spray Lube

| Vendor | Item# | Details | Price |
|-----------------------|----------|---|------------|
| INTEGRA/MILTEX | MIL3-700 | 8oz pre-mixed, non-silicone, anti-corrosive formula | \$9.82/btl |



Vulva Suture Pin



Vulva Suture Pin Insertion Needle.

| Vendor | Item# | Details | Price |
|------------------|---------|------------------|-----------|
| JORGENSEN | JOR24VI | Insertion Needle | \$9.00/ea |
| | JOR24V | Pin, 70mm | \$3.75/ea |
| | JOR24VS | Spacer, Pair | \$6.00/pr |

Finger Ring Cutter



| Vendor | Item# | Details | Price |
|------------------|----------|------------------------------|------------|
| JORGENSEN | JOR887 | 6 1/2" (16cm). | \$61.00/ea |
| | JOR887D1 | Replacement Blade for JOR887 | \$20.00/ea |

Ameriod Constrictors



For the surgical treatment of porto caval or hepatic shunts. This special designed product is used to encircle a blood vessel. A special material (hygroscopic compressed casein) inside the donut shaped constrictor imbibes fluid over time. It slowly occludes the blood vessel. A small key is used to lock it in place after it is slipped over the blood vessel. Sizing: about a 50% reduction in the blood vessel diameter should be achieved upon initial surgical placement for the best results. Sterile.



| Vendor | Item# | Details | Price |
|------------------|---------|---------|-------------|
| JORGENSEN | JOR659 | 5mm | \$104.00/ea |
| | JOR659A | 3.5mm | \$95.00/ea |



Catheter Tray

| Vendor | Item# | Details | Price |
|-----------------------|----------|---------------------------|------------|
| INTEGRA/MILTEX | MIL3-943 | 17 1/4 X 4 1/2 X 2 MILTEX | \$80.41/ea |

Curved Boning Knife

| Vendor | Item# | Details | Price |
|------------------|--------|---------|------------|
| JORGENSEN | JOR513 | 6" | \$30.00/ea |



Necropsy Knives

These high-quality molybdenum-hardened stainless steel bladed knives come with a yellow nylon no-slip grip handle. German-made.

| Vendor | Item# | Details | Price |
|------------------|---------|-------------------------------|------------|
| JORGENSEN | JOR515 | Curved, 6" | \$40.80/ea |
| | JOR507A | German-Made, Narrow Blade, 5" | \$29.40/ea |
| | JOR507B | German-Made, Narrow Blade, 7" | \$32.90/ea |
| | JOR502A | Wide Blade, 5" | \$28.20/ea |
| | JOR502B | Wide Blade, 7" | \$33.90/ea |

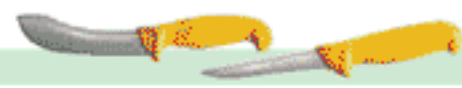

Diamond Sharpener

| Vendor | Item# | Details | Price |
|------------------|----------|---|---------|
| JORGENSEN | JOR902DM | Medium, Comes with leather case. | \$21.90 |
| | JOR902DS | Small, for easy carrying in a shirt pocket. | \$8.25 |



Surgical and Exam Supplies

Gowns; Surgical, Fluid Resistant &

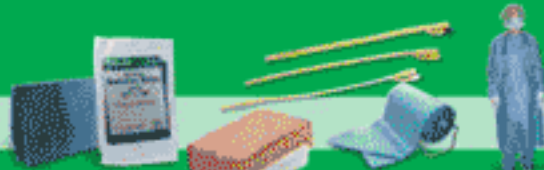

Sterile Surgeon Gown (A)

Made from SMS fabric, these sterile surgical gowns come individually packaged. Full back with wrap-around style and knit sleeves. Light blue. Comes with sterile towel.

| | | | |
|--------|----------|-----------|------------|
| OSGL | Large | \$3.29/ea | \$2.99/35+ |
| OSGM | Medium | \$3.29/ea | \$2.99/35+ |
| OSGXL | X-Large | \$3.29/ea | \$2.99/35+ |
| OSGXXL | XX-Large | \$3.29/ea | \$2.99/35+ |

Premium Sterile Surgeon Gown (B)

Sterile surgeon gown comes individually wrapped with towel. These gowns are made of a non-woven material that helps provide a barrier to blood, body fluids and pathogens. They offer a high level of protection without compromising comfort. They are cut wider through the chest and sleeves for a roomier fit and feature a velcro-style neck closure that allows the neckline to easily adjust to a wide variety of people. In addition, the velcro-style closure helps prevent gapping in the front of the gown to further protect against fluids. The gowns are very low linting, minimizing the risk of introducing particles into the O.R.

| | | | |
|----------|----------|-----------|------------|
| AHSSGL | Large | \$3.49/ea | \$3.29/30+ |
| AHSSGXL | X-Large | \$3.49/ea | \$3.29/30+ |
| AHSSGXXL | XX-Large | \$3.69/ea | \$3.59/30+ |

Disposable Non-Sterile Surgeon Gown (C)

These gowns are made of a non-woven material that helps provide a barrier to blood, body fluids and pathogens. They offer a high level of protection without compromising comfort. They are cut wider through the chest and sleeves for a roomier fit and feature a velcro-style neck closure that allows the neckline to easily adjust to a wide variety of people. In addition, the velcro-style closure helps prevent gapping in the front of the gown to further protect against fluids. The gowns are very low linting, minimizing the risk of introducing particles into the O.R.

| | | |
|----------|----------|-----------|
| MVGNSL | Large | \$1.99/ea |
| MVGNSXL | X-Large | \$1.99/ea |
| MVGNSXXL | XX-Large | \$2.29/ea |

Cloth Reusable Surgeon Gown (D)

100% cotton surgeon gown with tunnel belt, unisex. Finest quality surgeon gowns have sturdy double-stitched seams. Full 50" to 56" from shoulder to hem. Raglan sleeves with stockinette cuffs.

| | | |
|-----------|----------------------|------------|
| AHSGM-C | Medium, 100% Cotton | \$19.99/ea |
| AHSGL-C | Large, 100% Cotton | \$19.99/ea |
| AHSGXL-C | X-Large, 100% Cotton | \$19.99/ea |
| AHSGXXL-C | XX-L, 100% Cotton | \$20.99/ea |

Cloth Reusable Surgical Gown With Panel (E)

Critical-Coverage Gown. Surgical gown with chest and arm panel for extra protection.

| | | |
|----------|---------|------------|
| AHSGL-P | Large | \$27.99/ea |
| AHSGXL-P | X-Large | \$27.99/ea |

Jorvet Disposable Surgery Gown (F)

Full back with wrap-around style and knit sleeves. Light-blue fabric. Non-sterile. Can be safely autoclaved and even washed. **Jorvet**

NEW

| | | |
|---------|------------------------------|-----------|
| JOR739B | Sontara Fabric Gown, Medium | \$5.40/ea |
| JOR739A | Sontara Fabric Gown, Large | \$5.40/ea |
| JOR739C | Sontara Fabric Gown, X-Large | \$5.40/ea |
| JOR739P | SMS Fabric Gown, Medium | \$4.50/ea |
| JOR739M | SMS Fabric Gown, Large | \$4.50/ea |
| JOR739N | SMS Fabric Gown, X-Large | \$4.50/ea |

Jorvet Sterile Disposable Surgery Gown

Packed in a protective clear bag with a header, wrapped in standard CSR wrapper. Hand towel included. Regular procedure. Full back with wrap-around style. Knit fabric sleeves. Light blue. **Jorvet**

| | | |
|-----------|-----------------------------|------------|
| JOR738 | Sterile, Large | \$9.00/ea |
| JOR738L | Sterile, X-Large | \$9.90/ea |
| JOR738XP | Extended Procedure, Large | \$10.50/ea |
| JOR738XPL | Extended Procedure, X-Large | \$10.50/ea |



13822 WEST BOULTON BLVD. METTAWA, IL 60045

WWW.SHOPMEDVET.COM

Phone 800-544-7521

110

Fax 800-204-2177

Surgical and Exam Supplies

Surgical Gowns

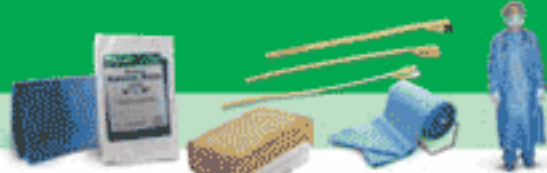

Proxima

NEW



MADE WITH SUPREL[®]
MEDICAL FABRIC



Aurora Surgical Gown



Proxima

NEW



Eclipse Surgical Gown



Aurora Surgical Gown

Aurora Gown, Non-Reinforced: Aurora gowns are made with Suprel medical fabric from DuPont. This innovative fabric is manufactured using a patented process (utilizing 18 patents) to create a fabric that's both highly protective and extremely comfortable. The fabric features an advanced composite technology that utilizes polyester (for strength) combined with polyethylene (for softness). Aurora gowns offer a high level of protection without compromising comfort. Featuring new fabric technology, Aurora raises the bar for single-use O.R. gowns. Aurora gowns have a smooth texture that glides easily without catching or grabbing, giving you incredible freedom of movement. Plus, the gown helps to quickly transfer heat away from your body, keeping you cool and comfortable. For a high level of protection, Aurora gowns are a great choice. The gown's high hydrostatic head offers superior barrier performance. They are cut wider through the chest and sleeves for a roomier fit and feature a velcro-style neck closure that allows the neckline to easily adjust to a wide variety of people. In addition, the velcro-style closure helps prevent gapping in the front of the gown to further protect against fluids. Aurora gowns are very low linting, minimizing the risk of introducing particles into the O.R. Aurora gowns meet the Standard for flammability of Clothing Textiles CPSC 16 CFR Part 1610.

| | | |
|-----------|--------------------------------------|-------------|
| DYNJP2701 | Large, Sterile with towel 30/case | \$143.92/cs |
| DYNJP2702 | X-Large, Sterile with towel 30/case | \$149.88/cs |
| DYNJP2703 | XX-Large, Sterile with towel 18/case | \$103.60/cs |

Eclipse Surgical Gown

Eclipse Gown, Non-Reinforced: The first feature you will notice about the Eclipse gown is the way it feels. The soft, cloth-like texture says "comfort" as soon as you put it on. Those who spend much of their day in a surgical gown will appreciate the comfort of Eclipse. Eclipse Gowns are cut wider through the chest and sleeves for a roomier fit. The Eclipse gowns feature a velcro-style neck closure that allows the neckline to easily adjust to a wide variety of people. In addition, the velcro-style closure helps prevent gapping in the front of the gown to further help protect against fluids. Eclipse Gowns are made with breathable Softesse medical fabric from DuPont. For more than 25 years, DuPont Softesse medical fabric has been considered an industry standard for medical gowns and drapes. The fabric features advanced material technology that provides a splash resistant barrier that's breathable. It keeps you cool and comfortable while you work, helping you feel confident and in control.

| | | |
|-----------|---------------------------------------|-------------|
| DYNJP2005 | Small, Sterile with towel 30/case | \$138.11/cs |
| DYNJP2001 | Large, Sterile with towel 30/case | \$138.11/cs |
| DYNJP2003 | XX-Large, Sterile with towel 18/case | \$136.29/cs |
| DYNJP2004 | XXX-Large, Sterile with towel 18/case | \$136.29/cs |

Fluid Resistant Isolation Gowns

Made from Lightweight Fluid-Resistant 4-Ply SMS material. Gowns feature strong seams to withstand fluids. Gowns are generously sized for full coverage and flexibility and are constructed with waist and neck ties to ensure a secure fit.



| | | |
|---------|---------------|------------|
| 27236 | 50/Cs Regular | \$29.00/cs |
| 27236XL | 50/Cs X-Large | \$39.00/cs |

Polyethylene Coated Gown

Polyethylene coated polypropylene gowns provide a high level of fluid protection. Waist and neck ties ensure that gowns remain securely in place to protect clothes.



| | | |
|---------|---------------|------------|
| 27114 | 50/Cs Regular | \$49.95/cs |
| 27114XL | 50/Cs X-Large | \$49.95/cs |

Isolation Gown JOR736

Fluid resistant. Yellow with full back. Knit fabric wrist cuffs. Universal size, full length with ties. Disposable. Universal Size.

| | | |
|--------|-----------------|------------|
| JOR736 | Yellow, 50/case | \$59.00/cs |
|--------|-----------------|------------|



Isolation Gown w/Poly Coat JOR737

Poly-coated with thin film of protective plastic for fluid repellency. Blue with elastic wrist cuffs. Universal size, full length with ties. Disposable. Universal Size

| | | |
|--------|---------------|------------|
| JOR737 | Blue, 50/case | \$69.00/cs |
|--------|---------------|------------|



13822 WEST BOULTON BLVD. METTAWA, IL 60045

Phone 800-544-7521

111

WWW.SHOPMEDVET.COM

Fax 800-204-2177

Surgical Apparel

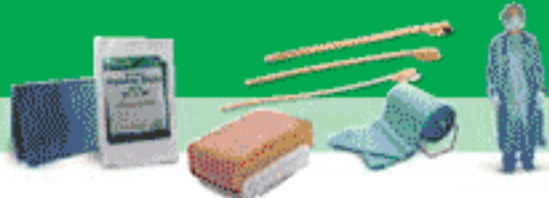

Surgical Masks

An excellent quality surgical mask can reduce exposure to blood and other bodily fluids with a 99% filtration fluid resistance. In today's medicine, a surgical mask is a necessary respiratory and contact precaution.



| | | | |
|-----------|-----------------------|------------|--------------|
| MASK-C | Cone, 50/bx | \$6.00/bx | 5+ \$5.00/bx |
| MASK-E | Earloop, 50/bx | \$5.00/bx | 5+ \$4.00/bx |
| MASK-T | Tie on, 50/bx | \$5.00/pk | 5+ \$4.00/bx |
| MASK-T-FF | Tie-on Fog Free 50/bx | \$11.50/bx | |

Surgeon Cap

- Durable
- Soft and comfortable
- Tie-on
- One size fits all
- Blue 100/bx

| | | |
|---------|--------|-----------|
| SURGCAP | 100/bx | \$9.99/bx |
|---------|--------|-----------|

SURGCAP



Bouffant Cap

Meets NFPA standards.

- Soft
- Breathable
- Elastic band opening
- Meets NFPA standards.
- No color choice

| | | |
|----------|--------|-----------|
| BOUFFANT | 100/bx | \$8.00/bx |
|----------|--------|-----------|

BOUFFANT



Shoecover

A soft, durable and lightweight shoe cover. Has a fuller cut and a more generous heel and instep. Designed to fit both large and small shoe sizes comfortably and snugly.

| | | |
|--------------|----------------|------------|
| SHOECOVER-XL | 200/bx X-Large | \$23.90/bx |
| SHOECOVER | 100/bx | \$8.00/bx |



Goggles Fog Free (with Vents)

Fluid Protective Goggles. Soft, vinyl-frame goggles fit easily over prescription eyewear. Four air vents provide additional comfort. Available with specially-treated, anti-fog lenses for clear, unobstructed viewing. Goggles meet ANSI standards and help your facility meet OSHA requirements for hazardous liquids. Fog Free



| Item# | Details | Price |
|----------|----------|-----------|
| NON24775 | Fog free | \$4.99/ea |



JorVet Eye Shields

Consists of reusable, lightweight frames, which thin, clear lenses snap onto.

- Removable protective film protects lenses before use.
- One size fits all.
- Frames come in an assortment of colors

| | | |
|---------|------------------------------------|-------------|
| JOR518 | 10 frames/25 shields | \$37.50/ea |
| JOR518S | Eye shields only refill kit, 25pk. | \$21.00/pk. |



JorVet Face Shield

Covers the entire face

- Consists of reusable, lightweight frames, which thin, clear lenses snap onto.
- One size fits all with an adjustable strap.
- Easily worn over glasses and masks.

| | | |
|---------|------------------------------|-------------|
| JOR519 | 10 frames/10 shields | \$61.50/ea |
| JOR519S | Face shields only kit, 10pk. | \$29.00/pk. |



Safety Goggles

Molded of soft clean flexible vinyl that conforms to the face and nose. Four vents eliminate fogging. Clear acetate lenses. Can be worn over regular glasses.

| | | |
|--------|-----------------------------|------------|
| JOR827 | 1/2"W adjustable head band. | \$26.70/ea |
|--------|-----------------------------|------------|

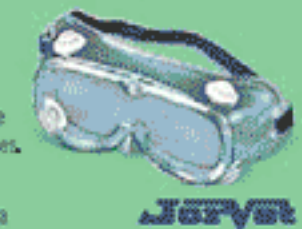

Surgery Cap with Ties

Surgeon's Cap with rear ties. Blue. 100/box. 5 bx/case.

| | | |
|--------|-----------------------|------------|
| JOR735 | 100/box, 5 boxes/case | \$48.00/cs |
|--------|-----------------------|------------|



Jorvet Surgery Mask

Molded Face Mask with elastic strap and malleable aluminum nose piece, molded cup.

| | | |
|--------|---------------------------|-------------|
| JOR732 | Blue. 50/box, 20 bx/case. | \$105.00/cs |
|--------|---------------------------|-------------|



Surgery Cap, Bouffant Style

O.R. Nurse/Super Bouffant Style Headwear. Blue. 24".

| | | |
|---------|--------------------------|------------|
| JOR734 | 21", 100/box, 5 bx/case. | \$42.00/cs |
| JOR734L | 24", 100/box, 5 bx/case. | \$49.00/cs |

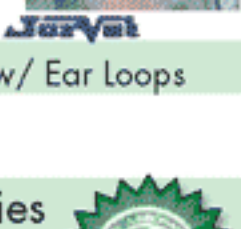

Surgical Procedure Mask w/ Ear Loops

Procedure Mask with earloops. 2-ply.

| | | |
|--------|---------------------|------------|
| JOR733 | 50/box, 12 bx/case. | \$58.00/cs |
|--------|---------------------|------------|

Surgery Mask, 3 ply w/ Ties

Surgery Mask with ties. Blue. 3-ply. 18cm x 20cm. Bulk packaged in dispensing box.

| | | |
|--------|--------------------|------------|
| JOR731 | 50/box, 6 bx/case. | \$36.00/cs |
|--------|--------------------|------------|



Leg Drapes

Made from the same high quality material as our surgical drapes. Available in two sizes.

| | | |
|-------------|---------------------|------------|
| EJLD24X30X9 | GREEN, 24"x 30"x 9" | \$10.09/ea |
| EJLD20X24X6 | GREEN, 20"x 24"x 6" | \$9.01/ea |



Surgical and Exam Supplies

Drapes

Sterile Surgical Drapes

Sterile surgical drapes made of SMS non-woven material. Consists of two outer layers of SMS and a middle layer of polypropylene. Outer layers: Cloth-like, yet tough and abrasion-resistant spunbound polypropylene. Inner layer: Intricate web of microfibers filter out many water-based liquids and dry particles.

| | | | |
|--------|-----------|-----------|---------------|
| DR1826 | 18" X 26" | \$0.65/ea | 300+\$0.50/ea |
| DR4042 | 40" X 42" | \$1.62/ea | 120+\$1.25/ea |
| DR6080 | 60" X 80" | \$2.99/ea | 60+\$2.50/ea |

as low as

50¢/300+



Fenestrated Drape

Cloth fenestrated drapes made from high quality surgical sheeting with built-in moisture barrier. Drapes are colorfast, washable, autoclavable and come in a choice of sizes.

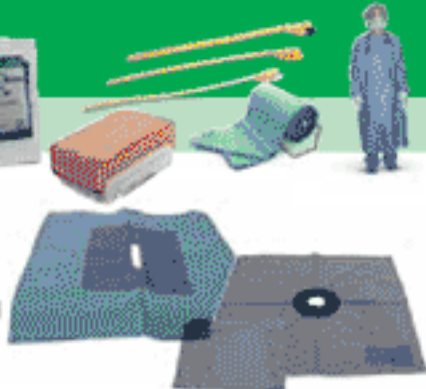

| | | | |
|---------|--------------------------------|-------------|------------|
| 2020-4 | 20" X 20" | 4" X 3/4" | \$7.99/ea |
| 2020-2R | 20" x 20", W/2" Circle Opening | 5" barrier | \$7.99/ea |
| 3030-2 | 30" X 30" | 2" X 1" | \$8.99/ea |
| 3030-4 | 30" X 30" | 4" X 3/4" | \$9.99/ea |
| 3030-7 | 30" X 30" | 7" X 1.25" | \$10.99/ea |
| 4040-4 | 40" X 40" | 4" X 3/4" | \$11.99/ea |
| 4040-7 | 40" X 40" | 7" X 1.25" | \$11.99/ea |
| 4040-10 | 40" X 40" | 10" X 1.25" | \$11.99/ea |

Disposable Surgical Drape Sontara

Sontara Disposable Surgical Drape. The original Jorvet drape with the blue, nch cloth-like feel of Sontara fabric packaged in a fan-folded box. 36" W x 100 yds in Length.



MVD 38" X 100 Yards \$75.00/bx

Jorvet Veterinary Surgical Drape

Quality surgical drapes of 50 percent cotton, 50 percent polyester, made of surgical grade textiles.

- Fenestrated drapes feature a moisture proof barrier near the fenestration that repels body fluids so that they do not soak.
- Through and draw up contaminants from beneath the drape into the surgical field.
- Durable quality, may be safely washed and autoclaved frequently.



| | | |
|---------|--|------------|
| JOR256A | 20" x 28", 4" x 3/4" opening | \$9.75/ea |
| JOR256B | 24" x 32", 2" x 1" opening | \$10.20/ea |
| JOR256C | 30" x 36", 7" x 1 1/4" opening | \$11.55/ea |
| JOR256D | 40" x 40", 9" x 1" opening | \$15.70/ea |
| JOR256E | 40" x 40", 4" x 3/4" opening | \$15.70/ea |
| JOR256F | 20" x 20", 2" circular opening. (for ophthalmic surgery) | \$10.35/ea |
| JOR256G | 20" x 24", 6" x 9" opening, Leg Drape | \$10.65/ea |
| JOR256H | 24" x 30", 9" x 12" opening, Leg Drape | \$12.30/ea |

Jorvet Impervious Drape

The base material is Sontara laminated with polyethylene film making it completely impervious. This drape has the highest tear strength of any drape fabric. It can be readily fenestrated at the time of surgery without the need for reinforcement. Fanfolded in easy opening header packer. Once you try this drape you will want it for all your extended procedures.

- Sterile individual wrap
- Covers entire patient

| | | |
|---------|-------------------------|-------------|
| JOR259A | 40" x 42" 5 pk, sterile | \$21.90/pkg |
| JOR259B | 60" x 80" 5 pk, sterile | \$48.00/pkg |



Adhesive Drape w/Povidine

Impregnated with povidine (antimicrobial). There is no fenestration. Can also be used post op for wound protection. Light amber color. Sterile.

| | | |
|---------|--------------------|------------|
| JOR2590 | 34" x 34", sterile | \$18.00/ea |
| JOR259R | 24" x 14" sterile | \$6.60/ea |
| JOR259S | 34" x 18" sterile | \$9.30/ea |



Jorvet Sontara Drape

Sontara Drape is a popular DuPont product that has a soft cloth like feel. It is fluid repellent, but fluids will strike through with extended exposure. It can be readily autoclaved. Sontara can also be coated with a clear poly film to make it impervious. However the impervious material cannot be autoclaved and is provided sterile.

| | | |
|----------|---------------------------------|-----------|
| JOR1060A | 44" x 55", non-sterile | \$3.90/ea |
| JOR1060B | 44" x 55", sterile, tyvek pouch | \$4.50/ea |
| JOR1060C | 55" x 77", non-sterile | \$4.90/ea |
| JOR1060D | 55" x 77", sterile, tyvek pouch | \$5.20/ea |

Jorvet Towel Drape Plain ACT Material

| | | |
|----------|-------------------------------------|------------|
| JOR1065A | 22" x 30" non-sterile, 4pk | \$5.20/pkg |
| JOR1065B | 22" x 30" sterile, 4pk, tyvek pouch | \$5.50/pkg |
| JOR1065C | 36" x 36" non-sterile, 4pk | \$7.20/pkg |
| JOR1065D | 36" x 36" sterile, 4pk, tyvek pouch | \$7.80/pkg |

Towel Drape Sontara

| | | |
|----------|-------------------------------------|------------|
| JOR1064A | 22" x 30" non-sterile, 4pk | \$3.80/pkg |
| JOR1064B | 22" x 30" sterile, 4pk, tyvek pouch | \$5.20/pkg |
| JOR1064C | 36" x 36" non-sterile, 4pk | \$7.10/pkg |
| JOR1064D | 36" x 36" sterile, 4pk, tyvek pouch | \$7.20/pkg |

Coated Sontara

| | | |
|----------|----------------------------------|------------|
| JOR1061C | 77" x 104", sterile, tyvek pouch | \$10.30/ea |
|----------|----------------------------------|------------|

Surgical Pack Wrapper

Double-layered reusable wrappers.

| | | |
|---------|---|------------|
| JOR257A | 18" x 18" | \$7.80/ea |
| JOR257B | 27" x 27" | \$10.05/ea |
| JOR257C | 10" x 12", Surgeon's Glove wrapper. Single Ply, Glove wrapper | \$4.95/ea |
| JOR257E | 24" x 24" | \$9.80/ea |
| JOR257F | 30" x 30" | \$11.10/ea |



13822 WEST BOULTON BLVD. METTAWA, IL 60045

Phone 800-544-7521

113

WWW.SHOPMEDVET.COM

Fax 800-204-2177

Surgical and Exam Supplies

Drapes & OR Towels

Disposable Drape **Jorvet**

The original Jorvet drape with the blue, rich cloth-like feel of Sontara fabric packaged in a fan-folded box. 38"W x 100 yds in a blue and red box. Variance may be 36" to 40".

JOR258 38" x 100 yds. \$75.00/ea

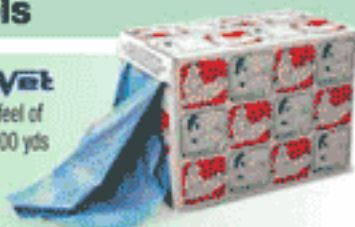

Disposable Surgical Drape SMS

This drape is made of SMS non-woven material. Consists of two blue outer layers of SMS and a middle layer of polypropylene. Fabric is low lint, helping to reduce wound contamination. Can be used as a drape, as fenestrated material or as a sterilization wrap. Autoclavable.

SMS40 40" x 100 Yards \$52.00/roll
SMS60 60" x 65 Yards \$52.00/roll

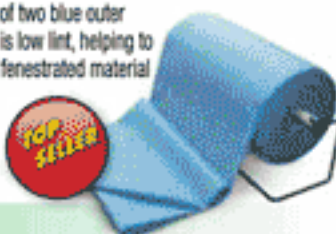

Drape Dispenser

Dispenser also available, for full roll quantities*. Can be desk or wall mounted. *Note: For dispenser to be utilized, you must order the entire roll. Only rolls are shipped with the cores necessary for dispenser use.

H29 24" Each \$21.95/ea



Oversize Pre-cut Sontara Drape

Large oversized drape that is great for equine or large animal use. Folded to open first in the long dimension.

JOR258Q 77" wide x 104" long. Sterile. \$10.00/bx



Extra-Wide Sontara Drape **Jorvet**

On dispensing roll. 60" x 100 yds. 22lbs.

JOR258W 60" x 100 yds. 22lbs. \$97.00/ea

ACT Drape **Jorvet**

DuPont's newer material (Advanced Composite Technology) is gaining popularity for drapes and gowns. It has an embossed pattern and is comparable to SMS material. The plain material can be autoclaved but the impervious drape must be provided in sterilized pouches.

JOR1062A 44" x 55", non-sterile \$3.80/ea
JOR1062B 44" x 55", sterile, tyvek pouch \$4.20/ea
JOR1062C 55" x 77", non-sterile \$4.70/ea
JOR1062D 55" x 77", sterile, tyvek pouch \$4.90/ea
JOR1062E 77" x 104", non-sterile \$7.00/ea
JOR1062F 77" x 104", sterile, tyvek pouch \$7.90/ea



Coated ACT Drape **Jorvet**

JOR1063A 40" x 42", sterile, tyvek pouch \$4.10/ea
JOR1063B 60" x 80", sterile, tyvek pouch \$6.70/ea
JOR1063C 77" x 104", sterile, tyvek pouch \$9.25/ea

Surgery Towel **Jorvet**

Huck-style. General purpose surgery towels. 100 percent cotton. Highly absorbent. Light blue.

JOR257D 17" x 33", 1 dozen \$36.00/dz



Combine Roll

Combine rolls, or composite padding, is a post-operative dressing used when excessive drainage from wounds demands more absorbency. The absorbent cotton, with a center layer of cellulose, has an exterior wrapping of soft non-woven fabric. Non-Sterile 20 yards in length.

3001 8" x 20 Yards \$17.99/ea
3002 12" x 20 Yards \$29.99/ea



Sterile Surgical Drape

Sterile 3 ply Surgical Drapes are excellent for use during minor surgical procedures. Two layers of absorbent tissue with a polyethylene lining in between help eliminate risk of bacterial migration and moisture strike through. Available in both plain for general use, and fenestrated to allow access to operative site while protecting the surrounding area. Sterile, latex free.

20-001 18" x 26" \$12.99/bx
20-002 18" x 26" 3ply Fenestrated \$14.99/bx

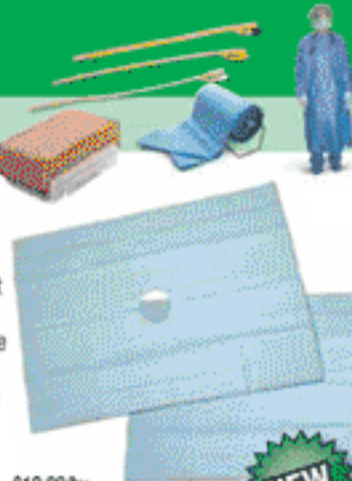

Jorvet Adhesive Surgical Drape w/Povidine

The majority of human surgeries use clear adhesive drape over the incision site. The rest of the patient is draped with standard non-woven disposable drape material. The clear adhesive drape offers several advantages:

1. Transparency—the film is ultra thin and highly transparent, which gives clear observation to the surgical field for locating anatomical landmarks.
2. Antibacterial—impregnated with povidine iodine giving the drape a slight orange tint. Very effective against most skin pathogens.
3. Fluid and pathogen resistance—sterile barrier prevents fluids or pathogens right up to the edge of the incision.
4. Permeable—allows the skin to breathe and vapor to pass.
5. High elasticity—follows natural contours for reliable gap-free adherence.
6. Low sensitivity—no irritation to skin or wound
7. Moderate viscosity—no injury to skin when removing the dressing.

Range of sizes, packaged sterile in sealed pouch

JOR1086A 6" x 8" Sterile, 20/box \$13.90/ea
JOR1086B 8" x 12", Sterile, 30/box \$23.40/ea

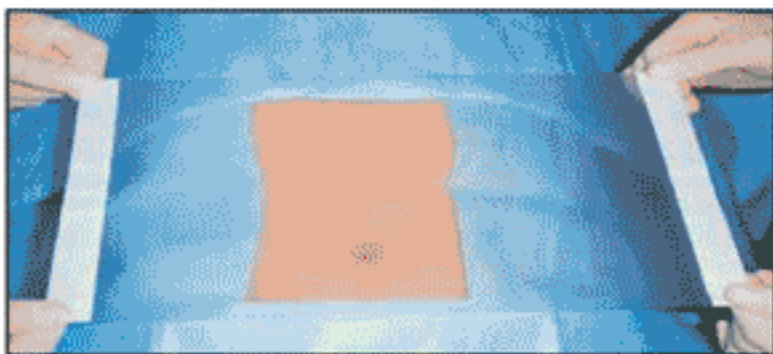

New Operating Towels

These new blue towels are made of 100% cotton. They measure 16" x 26" and are reusable. They can be autoclaved. These are top quality towels that will last a long time.

TOP SELLER
as low as
10+\$3.99/ea

AHSORT-B12 Cotton, 1 Dozen \$8.99/dz

Price Breaks
2+\$5.99/ea 3+\$4.99/ea 10+\$3.99/ea

Bulk Operating Towels

AHSORT-B100 16X26 100/cs \$49.95/cs

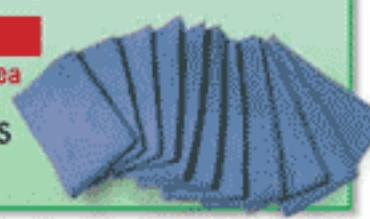

13822 WEST BOULTON BLVD. METTAWA, IL 60045

WWW.SHOPMEDVET.COM

Phone 800-544-7521

114

Fax 800-204-2177

Surgical and Exam Supplies

Iodine Solution/Scrub, Alcohol & Instrument Wraps

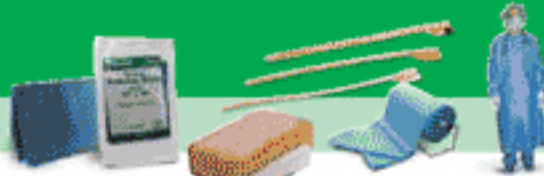

Povidone Iodine Solution

Prep solutions contain 10% weight by volume. Effective for skin and mucous membrane preparation prior to surgical pre- and post-operative. Solutions are antimicrobial solutions with surfactants, and contain 7.5% weight by volume Povidone Iodine, USP solution equivalent to 0.75% available iodine.

| | | |
|----------|----------|------------|
| PVPSOL-G | 1 Gallon | \$29.99/ea |
| PVPSOL-P | 16oz | \$4.29/ea |

Povidone Iodine Scrub Solution

Generous foaming action helps loosen foreign matter on skin. Rinses easily, leaving no residue. Emollient formulation is soft and non-drying to the skin.

| | | |
|----------|----------|------------|
| PVPSOL-G | 1 Gallon | \$29.99/ea |
| PVPSOL-P | 16oz | \$4.29/ea |



Alcohol Dispenser **JAVEL**

This handy pump bottle dispenses alcohol by pressing down on the top lid. Great for use in the exam room for alcohol wipes, pre-injections in vaccinations. 8 oz. amber polypropylene bottle.

| | | |
|--------|------|------------|
| JOR614 | 8 oz | \$12.00/ea |
|--------|------|------------|

Alcohol dispensing bottle

| | | |
|---------|-------------|-----------|
| JOR614G | Amber glass | \$6.90/ea |
|---------|-------------|-----------|



Facial Tissue

A silicone tubular drain that may be trimmed, peeled away, or used as a whole piece for surgical wound drainage. The drain can be split along its length or trimmed to suit individual requirements. Autoclavable. 40cm L drain of 12-3mm dia. catheters.

| | |
|-------|--------|
| 46580 | \$0.69 |
|-------|--------|



Isopropyl Alcohol

Cleans minor cuts, scrapes and burns while it reduces the risk of infection. Can be used in small amounts on affected areas one to three times daily. Once alcohol dries, wounds may be covered with sterile bandages. 70% U.S.P. Isopropyl alcohol by volume.

| | | |
|-------|------------|-----------|
| ALC-P | 16 Oz, 70% | \$1.59/ea |
|-------|------------|-----------|



Instrument Sorter **JAVEL**

Unique blue polyfoam instrument sorter allows individual separation of surgical instruments. The sorter has three individual compartments. Autoclavable. A great way to keep track of specialty instruments and protect delicate tips.

| | | |
|--------|------------------|------------|
| JOR485 | 11" x 10", 5/pk. | \$12.60/ea |
|--------|------------------|------------|

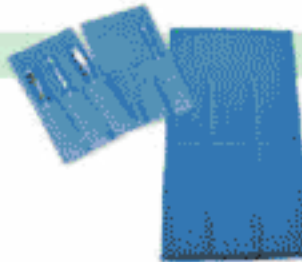

CSR Wrap

Our disposable autoclavable wrappers are superior to muslin and are virtually memory free. The natural construction of these disposable wrappers enables the user to wrap continuously without fear of skin sensitization. These products breathe easily and are also highly liquid repellent. Can be used as surgical.

| | | |
|------|--------------------|-------------|
| 1412 | 12" X 12", 1000/cs | \$50.00/cs |
| 1415 | 15" X 15", 1000/cs | \$65.00/cs |
| 1418 | 18" X 18", 1000/cs | \$92.40/cs |
| 1420 | 20" X 20", 1000/cs | \$109.83/cs |
| 1424 | 24" X 24", 500/cs | \$90.00/cs |
| 1430 | 30" X 30", 300/cs | \$72.06/cs |
| 1436 | 36" X 36", 300/cs | \$98.73/cs |
| 1440 | 40" X 40", 250/cs | \$120.00/cs |
| 1445 | 45" X 45", 250/cs | \$140.00/cs |
| 1448 | 48" X 48", 250/cs | \$173.00/cs |
| 1454 | 54" X 54", 100/cs | \$80.00/cs |



Cloth Instrument Wrap

High quality, 2-Ply, safety-surged instrument wraps. Made of durable, colorfast, washable surgical sheeting. No color choice.

| | | |
|-------|-----------|-----------|
| W1212 | 12" x 12" | /ea |
| W1818 | 18" x 18" | \$2.40/ea |
| W2424 | 24" x 24" | \$3.40/ea |
| W3030 | 30" x 30" | \$4.40/ea |
| W3636 | 36" x 36" | \$5.40/ea |



Alcohol Prep Pads

Before injections, alcohol prep pads are used as a topical antiseptic, anti-infective. The soft, absorbent, non-woven pads are saturated with 70% isopropyl alcohol, USP.

| | | |
|---------|-------------|-----------|
| APPEP | 70%, 200/bx | \$1.99/bx |
| APPEP-L | 70%, 100/bx | \$1.99/bx |



Closed Block Scrub Brush

Medium-textured nylon scrub brush with tapered tufts anchored by nickel-silver pins. Closed block, without nail cleaner on back.

| | | |
|---------|------|-----------|
| ANS1000 | 1 ea | \$2.99/ea |
|---------|------|-----------|



Povidone Iodine Prep Pads

Used to prep skin with antiseptic bactericidal that does not irritate or sting. Saturated with Povidone/Iodine Solution, 100 per box. 1-1/4" X 1-1/2" Folded

| | | |
|---------|--------|-----------|
| PVP-PAD | 100/bx | \$4.99/bx |
|---------|--------|-----------|



Surgical and Exam Supplies

Scrub Brush, Drains & Positioners

Sterile Surgical Scrub Brush

Features:

- Soft outer bristles clean thoroughly without skin irritation.
- Inner bristles are shorter and contoured for effective deep cleaning of fingers, nails and cuticles.
- Brush flexes for easier scrubbing between and around fingers.
- Convenient peel-open package.

| | | | |
|-------|-----------------|-----------|-------------------|
| BR105 | W/PVP IODINE | \$1.29/ea | \$1.19/30+ |
| BR115 | W/CHG HIBICLEN | \$1.29/ea | \$1.19/30+ |
| BR120 | W/PCMX SOLUTION | \$1.29/ea | \$1.19/30+ |
| BR125 | Dry Sterile | \$0.99/ea | \$0.89/30+ |

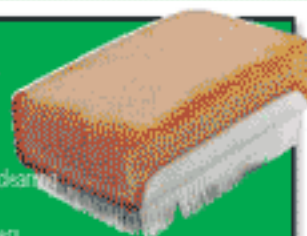

Surgical Scrub Applicator

Small, yellow sponge with plastic handle commonly used in human hospitals as an applicator for surgical scrub solutions such as Betadine.

JOR465 Sponge 2" x 2" x 1" thick. 8 3/4"L. 5/pkg. \$6.00/pkg.



Penrose Drain

Penrose drains are ideal for fast and proper drainage of secretions. Soft, latex rubber minimizes wound irritation and trauma. Wide range of sizes for varied needs. X-ray opaque for easy placement verification. Single use. Sterile.

| | | | |
|----------|------------|-----------|------------|
| PD18X1/4 | 18" x 1/4" | \$0.75/ea | \$0.59/25+ |
| PD18X3/8 | 18" x 3/8" | \$0.75/ea | \$0.59/25+ |
| PD18X1/2 | 18" x 1/2" | \$0.75/ea | \$0.59/25+ |
| PD18X5/8 | 18" x 5/8" | \$0.75/ea | \$0.59/25+ |
| PD18X3/4 | 18" x 3/4" | \$0.75/ea | \$0.59/25+ |
| PD18X7/8 | 18" x 7/8" | \$0.75/ea | \$0.59/25+ |
| PD18X1 | 18" x 1" | \$0.75/ea | \$0.59/25+ |



Penrose Tubing

Simple but effective pure latex drain for a variety of clinic uses. Sterile. 18"L. 50 individual peel pkgs/case.

| | | |
|---------|-------------|------------|
| JOR590A | 3/8" (10mm) | \$34.00/ea |
| JOR590B | 1/2" (15mm) | \$34.00/ea |



Surgical Tie-Downs

Wide-braided 3.8" polypropylene. Distributes tension over wide area. Royal blue color loop on one end. 4/bag

JOR171Q 4/bg \$5.10/bg

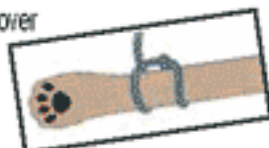

Jorvet Lexan Thoracic Positioner

Lightweight and easy to clean. V-shaped trough. Slightly elevated to help drain fluids away from patient. Radiolucent

| | | |
|---------|----------|------------|
| JOR279A | Small | \$27.00/ea |
| JOR279B | Medium | \$31.50/ea |
| JOR279C | Large | \$40.50/ea |
| JOR279S | Set of 3 | \$93.00/ea |



Thoracic Positioner

Made from tough, lightweight plastic, these thoracic positioners are warmer than stainless steel, very easy to clean and are transparent to light and x-ray

| | | |
|---------|--------------------------------|------------|
| EJTP-XS | X-small 6.5" X 5.5" Each | \$18.26/ea |
| EJTP-S | Small 8" X 7" Each | \$18.26/ea |
| EJTP-M | Medium 10" X 8" Each | \$21.82/ea |
| EJTP-L | Large 14" X 9" Each | \$27.28/ea |
| EJTP-A | Set of 3; Small, Medium, Large | \$63.35/ea |



Multi Arm Positioner

A great positioner or holder for surgery (i.e. arthroscopy) or radiology. Velcro straps securely hold limbs of patients ranging from cats to giant dog breeds.

- Moves in three joints or planes allowing positioning at any angle
- Mounting clamp fixes the device to any surgery or X-ray table
- A single lever locks all three joints rigid
- Additional use — holding endoscopes while performing biopsies, or grasping tissues

| | | |
|---------|---------------------|-------------|
| JOR930 | Single Limb | \$327.00/ea |
| JOR930A | Double limb bracket | \$222.00/ea |



Stifle Positioner

Developed in association with Professor Kurt Schulz of UC Davis Veterinary School, this attachment is especially designed for maintaining the stifle joint in proper position for an arthroscopy procedure. It is positioned above the stifle on the distal third of femur. Adjustment of positioner under draping is very simple.

| | | |
|---------|-----------------|-------------|
| JOR930X | Attachment only | \$320.00/ea |
|---------|-----------------|-------------|



Tomcat Positioner

Great positioner for restraining male cats and exposure of perineal area. Good for working with urethral obstructions and for neutering. No tie-downs or other assistance necessary. Lightweight and adjustable.

| | |
|---------|------------|
| JOR279T | \$39.00/ea |
|---------|------------|



Surgical and Exam Supplies

Catheters

Foley Catheter

An innovative manufacturing process provides the maximum amount of silicone coating available. Latex catheter is coated internally and externally in 100% silicone to resist encrustation and bacterial colonization. 2-way Foley. Sterile.

| | | | | | | | | |
|--------|------------|-----------|---------|-------------|-----------|---------|-------------|-----------|
| FC3X6 | 3cc x 6Fr | \$3.29/ea | FC5X20 | 5cc x 20Fr | \$1.50/ea | FC30X16 | 30cc x 16Fr | \$1.50/ea |
| FC3X8 | 3cc x 8Fr | \$3.29/ea | FC5X22 | 5cc x 22Fr | \$1.50/ea | FC30X18 | 30cc x 18Fr | \$1.50/ea |
| FC3X10 | 3cc x 10Fr | \$3.29/ea | FC5X24 | 5cc x 24Fr | \$1.50/ea | FC30X20 | 30cc x 20Fr | \$1.50/ea |
| FC5X12 | 5cc x 12Fr | \$1.50/ea | FC5X26 | 5cc x 26Fr | \$1.50/ea | FC30X22 | 30cc x 22Fr | \$1.50/ea |
| FC5X14 | 5cc x 14Fr | \$1.50/ea | FC5X28 | 5cc x 28Fr | \$1.50/ea | FC30X24 | 30cc x 24Fr | \$1.50/ea |
| FC5X16 | 5cc x 16Fr | \$1.50/ea | FC5X30 | 5cc x 30Fr | \$1.50/ea | FC30X26 | 30cc x 26Fr | \$1.50/ea |
| FC5X18 | 5cc x 18Fr | \$1.50/ea | FC30X12 | 30cc x 12Fr | \$1.50/ea | FC30X28 | 30cc x 28Fr | \$1.50/ea |
| | | | FC30X14 | 30cc x 14Fr | \$1.50/ea | FC30X30 | 30cc x 30Fr | \$1.50/ea |

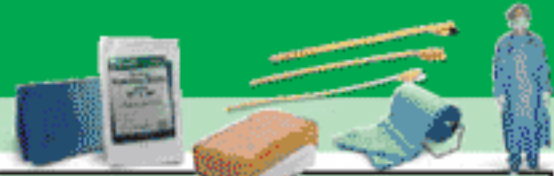

Plastic Urethral Catheter

Clear Vinyl Intermittent Self Catheters: Suitable for male or female catheterization. Smooth tip, comfort eyes and funnel end. Radiopaque. Male/Universal Clear Vinyl Intermittent Self Catheter.

| | | |
|-----------|-------------------|-----------|
| DYND10712 | 6Fr, 10" Length. | \$0.50/ea |
| DYND10713 | 8Fr, 10" Length. | \$0.50/ea |
| DYND10714 | 10Fr, 10" Length. | \$0.50/ea |
| DYND10722 | 12Fr, 16" Length. | \$0.50/ea |
| DYND10703 | 14Fr, 6" Length. | \$0.50/ea |
| DYND10723 | 14Fr, 16" Length. | \$0.50/ea |



Urethral Catheter

Red Rubber Latex Urethral Catheters: Suitable for male or female catheterization. Smooth tip, two oval eyes and funnel end. 16" length and radiopaque.

| | | |
|-----------|---------------|-----------|
| DYND13508 | 8fr, Sterile | \$1.00/ea |
| DYND13510 | 10fr, Sterile | \$1.00/ea |
| DYND13512 | 12fr, Sterile | \$1.00/ea |
| DYND13514 | 14fr, Sterile | \$1.00/ea |
| DYND13516 | 16fr, Sterile | \$1.00/ea |
| DYND13518 | 18fr, Sterile | \$1.00/ea |
| DYND13520 | 20fr, Sterile | \$1.00/ea |



Malecot Catheter

Amber latex rubber; 4-wing tip that collapses. Funnel end. Sterile.

JOR445A 10 Fr \$25.50/ea



Tom Cat Catheter (Kendall)

Semi-rigid polypropylene urinary catheter comes with adaptor to easily secure in place.

| | | |
|--------|------------------------------|-----------|
| 703005 | 3.5 french, 5.5", closed end | \$1.25/ea |
| 703021 | 3.5 french, 5.5", open end | \$1.15/ea |

Feline Urethral

These feline urethral catheters are stainless steel and have blunt olive tips to prevent damage. Available in packs of two or sets of six.

| | | |
|--------------|----------------------|------------|
| EJMOTF22X.5 | 22g x .5" 1.4mm tip | \$14.77/ea |
| EJMOTF22X1 | 22g x 1" 1.4mm tip | \$14.77/ea |
| EJMOTF22X1.5 | 22g x 1.5" 1.4mm tip | \$14.77/ea |
| EJMOTF6 | Feline Set Of 6 | \$43.72/ea |



Tom Cat Catheter (Jorgensen)

This silicon catheter with luer fitting and suture holes is more bio-friendly. Includes wire guide stylet.

| | | |
|---------|---------------|------------|
| JOR153X | Closed End 5" | \$25.20/ea |
| JOR153Y | Open End 5" | \$25.20/ea |

Canine Urinary Catheter

Constructed of a flexible transparent grade of nylon, producing firmness without rigidity. Female luer fitting. Closed end with lateral eye. Sterile.

| | | |
|----------|-------------------|-----------|
| JOR154XS | 4fr x 50cm (20") | \$6.00/ea |
| JOR154S | 6fr x 50cm (20") | \$6.00/ea |
| JOR154M | 8fr x 50cm (20") | \$6.00/ea |
| JOR154L | 10fr x 50cm (20") | \$7.20/ea |



Canine Catheter

Canine Female Catheter. Female luer fitting. Metal clearing rod included. 18cm x 2.5mm.

JOR90C 18 cm. x 2.5 mm. \$21.00/ea



Bitch Catheter

Bitch Urinary Catheter. Stainless steel. 10g heart-shaped finger rest. 101/2"L

JOR90H 10 1/2" \$12.60/ea



Jorvet Catheter Plug

Designed to temporarily plug feeding tubes and catheters (i.e. Foley), when not in use. Thumb grip.

JOR598 Sterile, 5/pk. \$9.00/pk



Endo Adapter

JOR157V 15mm x 15mm \$2.10/set



13822 WEST BOULTON BLVD. METTAWA, IL 60045

Phone 800-544-7521

WWW.SHOPMEDVET.COM

Fax 800-204-2177

Catheters & Skin Markers

Jackson Cat Catheter

This specially designed feline catheter is for aid in treatment of FLUTD. It is a modification of the standard feline catheter but with a shorter length (11cm) and metal stylette. There are convenient holes in the luer mount for suture attachment. Sterile. **Jorvet**

| | | |
|-----------|------------------|------------|
| JOR153JA | 3 French | \$7.50/ea |
| JOR153JB | 4 French | \$7.50/ea |
| JOR153JAS | 3 French, PORTEX | \$16.50/ea |
| JOR153JBS | 4 French, PORTEX | \$16.50/ea |

Foley Latex Catheter

Equine Use. Excellent for uterine flushes. Sterile. **Jorvet**

| | | |
|---------|------------------------------|------------|
| JOR447Q | 26fr x 16" with 30cc balloon | \$9.75/ea |
| JOR447R | 30fr x 16" with 30cc balloon | \$10.05/ea |

Silicone-coated amber latex Foley catheter. 2-way with opposed lateral eyes at tip. Sterile.
 JOR447S 6fr x 12" with 3cc balloon \$15.15/ea

Adapter Male Luer/Male Catheter

Male Luer Lock Connector with male is barbed on a Christmas tree connector. Also fits in a suction hose. **Jorvet**

JOR599 \$7.65/pk

Female Luer to Male Catheter

JOR597 5 pk \$16.50/pk **Jorvet**

Chambers Catheter

Stainless steel with slightly curved tip. Finger rest, luer slip adaptor. The preferred instrument for flushing the guttural pouch. Also can be used for uterine flushes.

JOR27G 8g, 22"L \$37.50/ea

Surgical Skin Marker w/Ruler

These surgical skin markers are routinely used in human cosmetic surgery. The special ink allows for ready identification of anatomical landmarks to be done before surgery. The markers come sterile and each have their own flexible metric and inches ruler. Color works on all ranges of pigmented skin. For best results, remove oil from the skin using alcohol before marking. 2/pk each in an individual sterile package.



JOR435 Sterile 2pk \$4.95/pk

Pezzar Catheter

Great for PEG feeding tubes. Mushroom tip assists in catheter retention, with 2cm and 4cm markings from tip's base to aid in proper catheter placement.

- Mushroom tip
- Soft silicone. 36 cm



| | | |
|---------|--|------------|
| JOR446M | 16FR O.D. x 3.2MM I.D. x 5.3MM O.D. | \$27.00/ea |
| JOR446P | 20fr O.D. 4.0mm I.D. 6.7mm O.D. | \$33.60/ea |
| JOR446R | 22fr O.D. 4.0mm I.D. 7.3mm O.D. X-Large 25mm dia. tip. | \$39.00/ea |

Silicone Acute Peritoneal Dialysis Catheter

In an emergency situation where peritoneal dialysis needs to be performed, this catheter is invaluable. The distal tip has a number of fenestrations for widespread drainage, plus is covered by a loose fitting dacron mesh that helps avoid obstructing these fenestrations. Sterile.



| Item# | Details | Price |
|--------|--|---------|
| JOR988 | 15fr (5mm) x 80cm. Distal portion is 16mm O.D. | \$78.25 |

Broncho Alveolar Lavage Catheter

This catheter is designed to perform lavage on upper rear section of the equine lung. It's main use is for the detection of "Bleeders" or exercise induced pulmonary hemorrhage. The BAL catheter can also be used for cytology or culturing the airways. The catheter is inserted nasally. The cuff inflated when in position. A 3-way stop cock is used for administration and aspiration of fluid. The stiffness of the catheter makes for ease of passage.

JOR639 30fr (10mm) x 240cm L, 10cc cuff \$48.00/ea **Jorvet**



Jorvet Suction Catheter

These catheters are used when regular suction handles are too large. One end will fit on a standard suction hose. A vent on the catheter allows for on/off suction control. 5 per package.

| | | | | | |
|---------|-----------|------------|---------|-----------|------------|
| JOR695 | 6Fr 5/Pk | \$10.95/pk | JOR695C | 14Fr 5/Pk | \$11.10/pk |
| JOR695A | 8Fr 5/Pk | \$10.95/pk | JOR695D | 18Fr 5/Pk | \$10.65/pk |
| JOR695B | 10Fr 5/Pk | \$10.95/pk | | | |



Shop 24/7 for your vet med supplies @ our Online Store

Have a question about your order?
 Our friendly customer service representatives are here to help

WWW.SHOPMEDVET.COM

Surgical and Exam Supplies

Suction Supplies

Yankauer Handle with Tubing

Yankauer features a slip-resistant handle for a secure grip. A smooth inner surface for maximum non-occluding flow and uniform tip to base diameter for fast evacuation. Yankauer Handle is also available with tubing in a 6 foot length.

YANK-HT w/tubing \$2.29/ea



Yankauer Handle

Yankauer features a slip-resistant handle for a secure grip. A smooth inner surface for maximum non-occluding flow and uniform tip to base diameter for fast evacuation. Yankauer Handle is also available with tubing in a 6 foot length.

YANK-H Handle, N/S \$0.50/ea



Jorvet Yankauer Suction Handle



Small removable tip has six vertical holes for suction. Fits standard suction hose. 22cm L.

JOR489ME Economy, Metal, 22cm L. \$21.00/ea
 JOR489M Metal, 22cm L. \$33.00/ea



Yankauer Suction Handle w/Thumb Control

Yankauer Suction Handle with thumb control vent. Same as JOR489, only with a thumb control vent. Small vent hole on the handle creates suction when blocked by thumb.

JOR489A 1/pkg. \$3.15/ea



Jorvet Yankauer Suction Handle

For aspiration of fluids during surgical procedures. Nylon. Can attach to JOR488 suction hose, as shown.

JOR489 Sterile. 1/pkg. \$3.00/ea



Suction Tubing

Top Quality - Sterile Suction Tubing

50216 3/16" x 6' \$1.10/ea
 50221 3/16" x 10' \$1.40/ea
 50246 1/4" x 6' \$1.10/ea
 50251 1/4" x 10' \$1.40/ea
 50252 1/4" x 12' \$1.50/ea



Jorvet Suction Hose

Top Quality - Sterile Suction Tubing

JOR488 1/4" I.D. x 6'. Sterile. 1/pkg. \$3.60/ea
 JOR488L 1/4" I.D. x 12'. Sterile. 1/pkg. \$4.20/ea



Suction Canister

Unlike liner systems, these canisters are rigid so there are no hidden dangers, no extra parts to clean, no potential for puncturing and no disassembly required. Plus, they're disposable. Your staff can throw away the whole canister after each case. There's no cleaning, substantially reducing the risk of infection. Hard canisters are easier to set up and easier to change out. Over time, they will save you time and money. And because the suction is better, applications get the maximum vacuum required.

SC800 800cc \$3.50/ea

Suction Canister

JOR459D1A 1200cc \$17.25/ea
 JOR459D1 800cc \$11.10/ea



Pool Suction Handle



Distal 1/3 end is vented with many holes. Fits standard suction hose. Screws apart for easy cleaning. Stainless steel.

JOR489P Metal, 8mm dia. 22cm L. \$34.50/ea
 JOR489PS Plastic \$5.70/ea



Jorvet Aspiration Suction Unit

This portable unit will provide powerful suction via an aspirator pump motor. Intraoperative suction of blood or body fluids. Attach to endoscope to keep field of vision clear or sample collection.

Features:

- Aspiration range 0-27" Hg
- Powerful 1/5 hp motor, most other units have only 1/10 hp
- Compact 14" L x 5 1/2" W x 10 1/2" H (35cm x 14cm x 26cm)
- In-line hydrophobic filter protects motor
- 800cc Storage canister
- Lightweight. 12.4 lbs.
- Five-year warranty



JOR459 14"L x 5 1/2"W x 10 1/2"H \$390.00/ea

Canister Only

JOR459D1A 1200cc \$17.25/ea
 JOR459D1 800cc \$11.10/ea



Lamps/Lights, Cautery Pens/Units

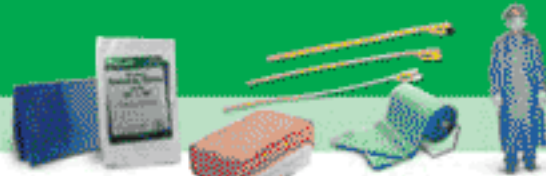

Surgical Head Lamp

Jorvet

Veterinarians often have a need for additional extra light during many procedures from surgery to oral exams. This inexpensive headlight provides hands free adjustable light-when and where you want it.

- Adjusts easily to all sizes
- Padded brim for comfort
- Battery operated (3 AAA included), no cords or wires
- LED bright light lasts thousands of hours
- LED light is adjustable to get light where you want it



JOR1036 LED Headlight with Batteries \$125.00/ea

Optimal Headlamp Magnifying Lens

Attaches to JOR1036 (sold separately) just below light.

- JOR1036D4 Magnifying Lens 2.75 x Working Distance 6" \$49.00/ea
- JOR1036D3 Magnifying Lens 2.25 x Working Distance 8" \$49.00/ea
- JOR1036D2 Magnifying Lens 1.75 x Working Distance 14" \$49.00/ea
- JOR1036D1 Magnifying Lens 1.50 x Working Distance 20" \$49.00/ea



Jorvet Halogen Penlight

The Jorvet Penlight with halogen bulb offers 400 percent more candle power than standard penlights.

JOR114BH Uses two "AA" batteries, included. \$33.00



Jorvet

Jorvet Thermal Cautery Unit

The TCU provides all the cautery power necessary for treating the numerous minor surgical conditions seen by veterinarians in everyday practice. The cautery unit is ideal for dermatological and ophthalmologic applications, or any procedure that requires accurate hemostasis. The autoclavable handpiece with six-foot cord accepts an assortment of reusable thermal cautery electrodes, allowing maximum flexibility to perform a wide variety of procedures. Unit comes with 3 tips.

Other benefits include:

- No aberrant radio frequency currents to cause
- Unintended tissue damage or shock.
- Unlike disposable battery powered cauteries, the TCU maintains the desired temperature during tissue contact and does not rapidly diminish.
- 50" (12.7cm) D x 5" (12.7cm) W x 8"
- (20.3cm) H, 4 lbs. (1.8kg)
- Warranty: 1 year

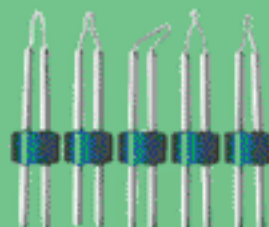

Vet Use



Cordless Cautery Convenient Kit

Features:

Hand piece uses two AA batteries (included)

- (4) Replaceable cautery tips:
- (2) 1/2" Fine electrode, useful for hemostasis control
- (2) 1/2" Loop electrode for wide use, such as small skin tumors
- Delivers high temp up to 2250° F
- All tips fit easily into the hand piece.

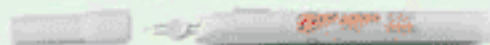
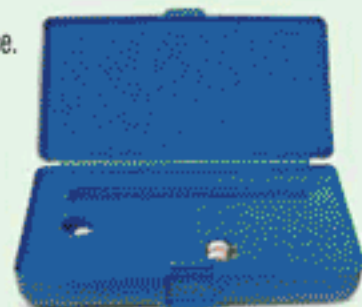

| | | |
|----------|--------------------------|------------|
| JOR313 | Complete Kit | \$63.00/ea |
| JOR313W | Fine tip 1/2" | \$11.10/ea |
| JOR313Z | Loop tip 5" | \$11.10/ea |
| JOR313Y | Fine tip 5" | \$11.10/ea |
| JOR313X | Loop tip 1/2" | \$11.10/ea |
| JOR313D1 | Sterile sleeves, 10 pack | \$27.30/pk |

Portable Cordless Cautery Pen

Small portable cautery, excellent for hemostasis. Uses AA batteries (included). 5/8" fine tip. Cordless and lightweight. High Temp 2250F.

- JOR313A High Temp 2250°F \$33.00/ea
- JOR313B Low Temp 1350°F \$27.60/ea

Jorvet



Jorvet

| | | |
|-------------|--------------------------------|-------------|
| JOR846 | Cautery Unit | \$590.00/ea |
| JOR846D1 | Non-sterile; may be autoclaved | \$178.00/ea |
| Tips | | |
| JOR846A | Loop Tip | \$58.00/ea |
| JOR846B | Fine Flat Tip | \$58.00/ea |
| JOR846C | Angled Loop Tip | \$58.00/ea |
| JOR846D | Bail Point Tip | \$65.00/ea |
| JOR846E | Fine Tip | \$58.00/ea |

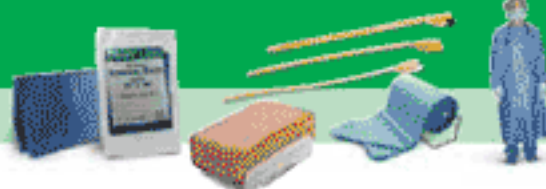

Jorvet Electrosurgical Unit

Jorvet

The most affordable unit available for today's veterinary surgeon. With more than enough power for any procedure.

Features:

- 3 operating modes at the turn of a dial
- Fully filtered: smooth cutting
- Fully rectified: cutting & coagulation
- Partially rectified: Coagulation: larger bleeders
- 10 different power settings
- Wide selection of electrodes included
- Includes ground plate



JOR470 3 Modes \$735.00/ea

Electrosurgical Unit Electrode

Jorvet

The most affordable unit available for today's veterinary surgeon. With more than enough power for any procedure.

JOR470D1 One Prong and autoclavable \$90.00/ea



Electrosurgical Unit Electrode

Jorvet

Autoclavable. 1/16" Use only with JOR470 unit
NOTE: DO NOT store in liquids.

- | | | |
|-----------|------------|------------|
| JOR470DT2 | Large Loop | \$12.00/ea |
| JOR470DT3 | Small Loop | \$12.00/ea |
| JOR470DT5 | Fine Wire | \$12.00/ea |
| JOR470DT4 | Heavy Wire | \$12.00/ea |



- The wide range of Jorvet Electrodes come in four different types.
- 3/32" Autoclavable. Use only with JOR484m
- BIPolar. Autoclavable. Use with JOR484m and JOR470 (needs bipolar convertor)
- 3/32" Disposable. Autoclavable. Raised grip for easy removal. Use only with JOR484m unit
- 1/16" Autoclavable. Use only with JOR470 unit

Jorvet Reusable Electrodes

Jorvet

Autoclavable 3/32"

| | | |
|----------|-------------------------|------------|
| JOR484A1 | Angled Fine Needle | \$51.50/ea |
| JOR484A2 | Angled | \$42.00/ea |
| JOR484A3 | Angled Sharp | \$45.00/ea |
| JOR484A4 | Angle, Ball | \$49.50/ea |
| JOR484A5 | Straight Ball | \$51.00/ea |
| JOR484A6 | Straight Needle | \$48.00/ea |
| JOR484A6 | Straight Needle | \$48.00/ea |
| JOR484A7 | Long Straight Ball | \$49.50/ea |
| JOR484A8 | Long Straight Needle | \$49.50/ea |
| JOR484A9 | Triangle electrode 1/2" | \$26.50/ea |



Reusable Bipolar Forceps

Autoclavable **Jorvet**

| | | |
|----------|--------------------------------|-------------|
| JOR484B1 | Fine Forceps. 5" | \$260.00/ea |
| JOR484B2 | Medium Forceps. 5 1/2" | \$260.00/ea |
| JOR484B3 | Curved Fine Forceps. 5" | \$260.00/ea |
| JOR484B4 | Curved Fine Forceps. 7" | \$260.00/ea |
| JOR484B5 | Straight Fine Forceps. 7" | \$260.00/ea |
| JOR484B7 | Bayonet Fine Forceps. 7 1/2" | \$260.00/ea |
| JOR484B6 | Bayonet Medium Forceps. 7 1/2" | \$260.00/ea |
| JOR484BC | Bipolar Cord for JOR484m | \$113.00/ea |



Disposable Electrode

Jorvet

3/32", 25/box, standard needle

| | | |
|-----------|-------------------------|------------|
| JOR484AD4 | Standard Needle. 25/box | \$68.00/ea |
| JOR484AD5 | Standard Blade. 50/box | \$88.00/ea |



Jorvet Reusable Loop Electrode

Jorvet

Great for removing skin tumors. 3/32", Loop, 3/8" dia

| | | |
|-----------|----------------------|------------|
| JOR484AD1 | re-usable 1/4", each | \$44.75/ea |
| JOR484AD2 | Loop, 3/8" dia | \$42.50/ea |
| JOR484AD3 | Re-usable 1/2", each | \$43.00/ea |



Jorvet Diamond Electrode

Jorvet

Diamond Electrode. Reusable. 3/32"

| | | |
|-----------|------------------------|------------|
| JOR484A13 | Diamond electrode 1/4" | \$26.50/ea |
| JOR484A14 | Diamond electrode 1/8" | \$26.50/ea |



Jorvet Triangle Electrode

Jorvet

| | | |
|-----------|------------------------|-----------------|
| JOR484A11 | 1/8", Reusable. 3/32". | 1/8" \$26.50/ea |
|-----------|------------------------|-----------------|



Jorvet Electrode Autoclavable 1/16"

Jorvet

Autoclavable. 1/16" Use only with JOR470 unit
NOTE: DO NOT store in liquids.

| | | |
|----------|-----------------|------------|
| JOR470D1 | Diamond Loop | \$12.00/ea |
| JOR470D2 | Large Loop | \$12.00/ea |
| JOR470D3 | Small Loop | \$12.00/ea |
| JOR470D4 | Heavy Wire | \$12.00/ea |
| JOR470D5 | Fine Wire | \$12.00/ea |
| JOR470D7 | Small Oval Loop | \$12.00/ea |
| JOR470D9 | Ball Electrode | \$12.00/ea |

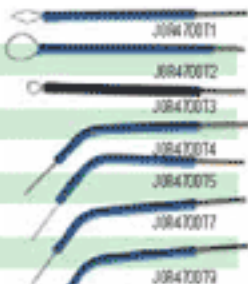

Electricosurgical Units & Accessories

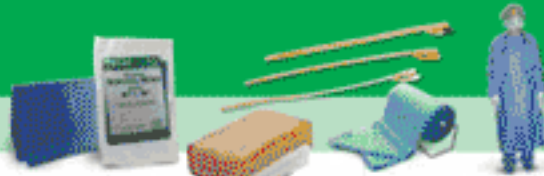

Bovie 2250 Digital Electrosurge Generator

A more powerful unit is needed when doing specialized endoscopy procedures like OHE's or spays. This unit will work well with Richard Wolf's Powerblade and other brands of bipolar endoscopy equipment. The increased power is the cut format: 200 watts, fulguration: 80 watts, bipolar: 80 watts. Uses the same JOR484 3/32" tips shown on the following page. 12.3"W x 16.30 x 6"H. Accessories included:

- Two disp hand pieces (JOR484mdla)
- Autoclavable hand piece (JOR484mdlc)
- Reusable body or ground plate
- Five different electrodes
- Two Electrodes - standard needle (JOR484ad4*)
- x Three Electrodes - standard blade. (JOR484ad5)*Two-year warranty Optional Item: JOR484ad1 Bipolar Foot Switch



JOR484X **Jorvet** \$5,520.00/ea
 JOR484TA Table Top Stand \$77.00/ea



Deluxe 1250 Bovie Electrosurgical Unit

This is a top-of-the-line Electro surgical unit made by the original Bovie Company. They first invented the Electro surgical unit in the 1920s. The complete table top unit is fitted with veterinary specific equipment. Five modes: cutting, cutting/coagulation, coagulation, fulguration, bipolar. User has option of handpiece finger switch or foot control. Rotary dial operates power; shown in 1 watt increments via LED readout

- Reusable body pad (ground plate)
- Built-in bipolar (requires optional foot pedal)
- Five 3/32" electrodes; interchangeable with other same size brands
- 10 1/4"W x 5 1/2"H x 10"D, 14 lbs.
- U.L. approved Accessories included:
- Two Disposable Handpieces (JOR484md1a)
- Autoclavable Handpiece (JOR484md1c).



JOR484M NOTE: Bipolar forceps and cord sold separately. \$3,550.00/ea
 Must purchase foot pedal switch for bipolar.
 JOR484M99 Foot pedal for bipolar applications.
 JOR484MV 220V \$3,430.00/ea

Accessories

Handpiece for Disposable Cautery **Jorvet**
 JOR484MD1A Disposable handpiece for Bovie 1250 electrosurgical unit \$13.20/ea

Jorvet Autoclavable Handpiece **Jorvet**
 Bovie 1250 autoclavable handpiece
 JOR484MD1C \$45.00/ea

Jorvet Reusable Bipolar Forceps **Jorvet**
 The foot pedal is necessary for bi-polar procedures
 JOR484MD9 Foot pedal for bovie 1250 \$474.00/ea

Jorvet Foot Switch **Jorvet**
 Foot pedal for JOR484, Electrosurgical Generating System
 JOR484D2 \$116.00/ea

Deluxe Electrosurgical Grounding Plate & Cord **Jorvet**
 Can only be used with J484 unit
 JOR484D3 \$186.00/ea
Ground Plate Cord for JOR484M
 JOR484MD4 \$98.00/ea

Ground Plate Cord Only Ground Plate cord only for J484v
 JOR484D3C \$107.00/ea
Ground Plate Only **Jorvet**
 Ground plate only for J484 & J484M
 JOR484D3P \$89.00/ea

Tube Gauze

Commonly used in bandaging cat declaws. Also can be used as a stockinette on cats and smaller animals. A very fine weave of 100% cotton that is knitted in a continuous seamless tube. Roll in dispensing box.

JOR290A Roll 5/8"(w) x 50 yards \$18.00/ea
 JOR290B 1" x 50 yards \$21.00/ea



Tube Gauze Applicator (for 5/8" tube gauze)

JOR290AP Metal applicator cage for 5/8" tube gauze \$43.50/ea

Verruca-Freeze Starter Kit

RXVERRUICA-L Cryo Buds large, 8-10mm, 30/pk \$30.00/pk
 RXVERRUICA-REF Refill Canister: 60-70 freezes \$255.00/btl
 RXVERRUICA-M Cryo Buds medium 4-6mm, 30/pk \$30.00/pk
 RXVERRUICA-S Cryo Buds small, 2mm, 30/pk \$30.00/pk
 RXVERRUICA starter kit: 60-70 freezes with \$275.00/pk
 cones and buds



Jorvet Smoke Shark

Noxious smoke is generated when using either an electrosurgical unit or surgical laser. At the very least, smoke is a nuisance odor, and at worst, an occupational health hazard. The smoke shark is designed to remove smoke and particulate matter generated by electrosurgical generators or lasers at the operative sight. The Smoke Shark unit consists of a smoke evacuation power unit, filter canister, and various tubing attachments. The four stage filter captures particles down to 0.01µm with over 99.99 percent efficiency. The filter has an 18-hour shelf life and contains 24 ounces of carbon, giving it superior ability to eliminate odors. Tubing (B) connects the filter to the surgery site. A small arm stand holds the tubing close to the surgical site without contaminating the sterile field. Features:

- Line voltage: 120 VAC ± 10%
- Line frequency: 50-60 Hz
- 17.78 cm (7") W x 29.85 cm (11.75") H x 46.36 cm (18.25") D
- Weight: < 6.5 kg (< 14 lbs.) w/o filter

JOR483 Complete with: \$1,960.00/ea
 • Smoke Shark power unit
 • Long life filter
 • 6' tubing (24/pk)
 • Foot switch
 • Arm stand



Smoke Shark Arm Stand
 JOR483D5 \$176.00

Smoke Shark Footswitch **Jorvet**
 JOR483D4 \$188.00

Smoke Shark (Power Unit Only) **Jorvet**
 JOR483D6 \$1,410.00

Smoke Shark Tubing **Jorvet**
 JOR483D3 Tubing, 7/8" x 6 ft. (24/pk)\$186.00

Smoke Shark Tubing **Jorvet**
 JOR483D3 Tubing, 7/8" x 6 ft. (24/pk)\$186.00



Underpads, Biosecurity Apparel & Pill Counting

Disposable Underpads

Disposable Underpads economy weight, light absorbency, feature diamond-embossed fluff-fill to help control fluid leaks. Added embossed polypropylene backing controls slipping to reduce the risk of leaks on patients and bedding.

| | | | |
|------------|-----------|--------|------------|
| UPAD1724CS | 17" x 24" | 300/cs | \$39.00/cs |
| UPAD2324CS | 23" x 24" | 200/cs | \$39.00/cs |
| UPAD2336CS | 23" x 36" | 150/cs | \$39.00/cs |



Underpads

Protection Plus® Disposable Underpads deluxe weight, heavy absorbency, feature diamond-embossed fluff-fill to help control fluid leaks. Added embossed polypropylene backing controls slipping to reduce the risk of leaks on patients and bedding.

Economy Weight Disposable Underpads

| | | | |
|--------|-----------|----------|------------|
| 281227 | 30" x 30" | 150/case | \$41.00/cs |
|--------|-----------|----------|------------|

Standard Weight Disposable Underpads

| | | | |
|--------|-----------|----------|------------|
| 281230 | 17" x 24" | 300/cs | \$49.00/cs |
| 281241 | 23" x 24" | 200/case | \$49.00/cs |
| 281242 | 23" x 36" | 150/case | \$49.00/cs |
| 281245 | 30" x 30" | 150/case | \$51.00/cs |

Deluxe Weight Disposable Underpads

| | | | |
|--------|-----------|----------|------------|
| 281260 | 17" x 24" | 300/cs | \$54.00/cs |
| 281264 | 23" x 36" | 150/case | \$53.00/cs |

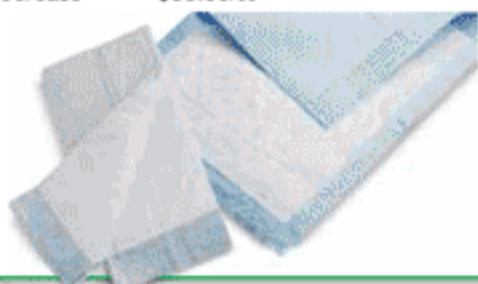

Pill Counting Tray

Handy device for counting out pills for accurate prescription count. Plastic. (spatula not included)

JOR697 6"W x 8"L. \$15.90/ea

JorVet

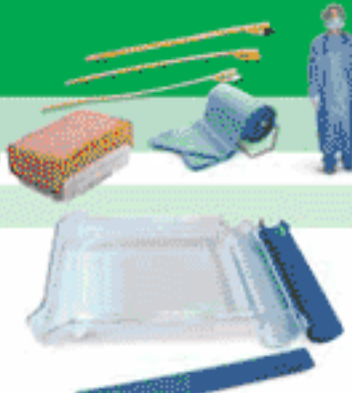

Veterinary Biosecurity Protective Apparel Kit

Veterinarians and associated animal health care workers are in contact with some highly contagious diseases. There is a real need for biosecurity to prevent that pathogen from spreading further. Outbreaks of highly contagious diseases like:

- Equine Rhinopneumonitis (herpes)
- Canine Influenza
- Salmonella
- Equine strangles and others

Veterinarians and staff are at risk of becoming the vehicle that spreads these diseases further. JorVet, in cooperation with a leading veterinary teaching hospital has developed a protective apparel kit that provides protective apparel and reduces the risk of these dangerous pathogens being spread by the very person responsible for controlling it.

The kit consists of:

- White posewear coveralls with hood and zipper
- Procedure mask with ties
- Disposable blue plastic boots (pr) JOR100B
- Disposable purple nitrile gloves (2 pair)
- Alcohol wipes (2)
- Biohazard disposal bag
- Zip lock storage bag with direction



| | | |
|-----------|--|------------|
| JOR1035 | Standard size (Large) | \$17.80/ea |
| JOR1035XL | Extra Large size Note: Sizing runs small | \$18.25/ea |

JorVet Rectal Ring

JorVet rectal rings are precision-machined acrylic plastic with tapered ends for easy insertion.

| | | |
|---------|-----------------|------------|
| JOR155B | 5/8 x 2, 24 pk. | \$25.50/pk |
| JOR155C | 3/4 x 2, 24 pk. | \$30.00/pk |
| JOR155D | 7/8 x 2, 24 pk. | \$30.00/pk |
| JOR155E | 1 x 2, 24 pk. | \$33.00/pk |



JorVet

Fecal Loop

Inexpensive plastic loop with slotted ends for quick and easy fecal samples. Reusable. This can easily be inserted into the rectum and a small amount of fecal material trapped in the loop. Can be cleaned, disinfected, and used repeatedly. Two convenient sizes available.

| | | |
|---------|-------------------------------------|-----------|
| JOR147 | Standard size. 9" x 3/8". | \$2.55/ea |
| JOR147P | Puppy & Kitten size. 4 3/4" x 1/4". | \$2.55/ea |

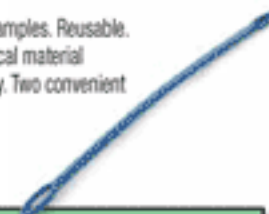

Drench Pump JorVet

Drench Pump for administering large doses of fluid orally. A continuous flow pump that puts out liquid on both the up and down stroke.

JOR132 Pump \$69.00/ea



Irrigating Cannula

These plastic cannula are used for irrigation of the lacrimal ducts, wounds, glands, etc. Rounded ends. Flexible tip. Sterile.

JOR150A Small, 5/pk \$38.40/pk



Silver Nitrate Applicator

Applicators with silver nitrate. These 6" applicators come 100 per package.

SNA6 100/pk \$24.95/ea

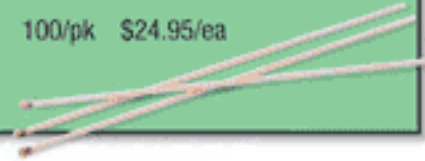

Surgical and Exam Supplies

Depressors, Thermometers, & White Goods

Wooden Tongue Depressor

Made from close-grained northern white birch, with high tensile strength and a smooth, polished surface. These tongue depressors are odorless, tasteless and offer great patient comfort.

| | | | | |
|------|-----------------|--------|-----------|--------------|
| TDJ | Jr, Non-Sterile | 500/bx | \$6.49/bx | 10+\$5.99/ea |
| TDS | Sr, Non-Sterile | 500/bx | \$6.49/bx | 10+\$5.99/ea |
| TDSS | Sterile | 100/bx | \$3.95/bx | 10+\$3.49/ea |

Jorvet Wooden Tongue Depressor

Quality birchwood tongue depressors enjoy a wide variety of uses around the veterinary clinic. 500/box 10 boxes/case, standard size 6" x 3/4".

JOR196 500, 6" x 3/4" \$8.70/bx

Jorvet Tongue Depressor

For small animals. Excellent illumination for oral and laryngeal exams. Use with JOR114bh lightsource. Cold sterilization only.

JOR114T 2 pack \$5.40/ea

Jorvet

Digital Thermometer

Our digital thermometers provide accurate temperatures in about 60 seconds. These thermometers have a simple push-button start and a large LCD screen for easy readings. Disposable sheaths allow for sanitary oral, rectal or auxiliary use.

DIGITAL Each \$4.99/ea

Thermometer Sheath

Thermometer sheath, rectal, digital, pre-lubricated

MDS9608 100/bx \$6.33

Small Animal Thermometer **Jorvet**

Quality 4" stubby bulb rectal thermometer with a tri-top end, allowing non-slip insertion and removal, as well as not rolling off a flat surface. Complete with handy 2-piece plastic carrying case for safety and hygiene. Gold glass backing for quick and easy readouts. Full Fahrenheit scale of 96° to 106°. Guaranteed to comply with ASTM E667 specifications.

JOR460 12/box \$12.60/dz

Ring Top Thermometer **Jorvet**

5" heavy-duty ring top thermometers. 12 per box

JOR187R Without case \$27.00/bx

Thermometer and Case **Jorvet**

Gold colored backing for quick and easy Fahrenheit scale readouts. Heavy-duty with ring top. 5"L. Available with or without a case.

JOR187Q 1 Dozen, Without Display Card \$30.00/bx

JOR187QD 1 Dozen, Comes with Display cards \$36.00/ea

Cotton-Tipped Applicators

Single end Non-Sterile. 1000 per box.

CTA6 6", 1000/bx \$4.99/bx

CTA3 3", 1000/bx \$4.99/bx

as low as

10+\$4.49/ea

Jorvet Cotton-Tip Applicator

Our Jorvet cotton tip applicators are 6"L and come with a wooden stem and single cotton tip. 100/bag, 24 bags/box. **Jorvet**

JOR195 6", 100/bag, 24pk \$13.00/bx

Applicator Sticks **Jorvet**

6" hardwood applicator stick useful for mixing and stirring compounds and lab samples. Handy zip lock bag. 100/bag, 24 bags/carton.

JOR195A 100/bag, 24-pack \$9.00/ct

Sundry Jars



These deluxe sundry jars feature unbreakable plastic in either white opaque or clear polystyrene. Jars are permanently labeled in blue and come with clear lids for easy viewing.

| | | |
|--------|--------------------|------------|
| 39-800 | White Opaque 5/Set | \$22.00/ea |
| 39-801 | White Opaque Each | \$5.00/ea |
| 39-802 | Clear 5/Set | \$22.00/ea |
| 39-803 | Clear Each | \$5.00/ea |

Non-Sterile Cotton Balls

COTBALL Medium, 4000/cs \$14.99/cs

COTBALL-LG Large, 2000/cs #19.99/cs

Oasis



SEE OUR COTTON & GAUZE SECTION FOR A FULL RANGE OF WHITE GOODS

13822 WEST BOULTON BLVD. METTAWA, IL 60045

WWW.SHOPMEDVET.COM

Phone 800-544-7521

124

Fax 800-204-2177

Surgical and Exam Supplies

Lube, Tourniquets & Disposable Towels

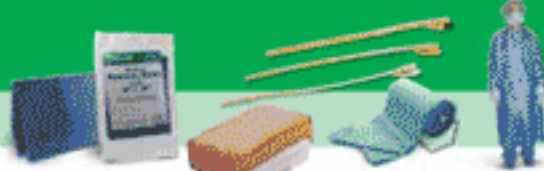

Jorvet Gallon J-Jelly Lube

An ideal all around lubricant for rectal and obstetrical procedures. J-Jelly is greaseless, water soluble, and non-irritating. It will not harm rubber, Plastic, or glass surfaces. Contains methylcellulose.

JOR109JB Gallon \$19.95/gl
JOR109F 8 oz. reusable flask \$2.85/ea



Lubricating Jelly

An ideal water soluble lubricant for general needs.

LUBE-J 4 oz. **\$1.50/ea**



J-Lube Powder

Concentrated powder that dissolves easily in water and is a very effective obstetrical lubricant. J-LUBE® is completely inert and non-irritating. 10 oz. plastic bottle with shaker top makes 6-8 gallons of lubricant. For veterinary use only.

JOR109 10 oz., 4.5 meters \$11.70/ea



Lubricating Jelly Sterile

LUBE-5G150 5gm foil pack \$10.99/box

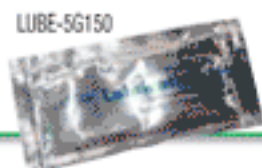

Multi-Fold Towel

Multi-fold towels, 9.25" x 9.25", 4000/cs, various manufacturers.

P-TOWEL White \$24.00/cs

Paper Towel C-Fold

High-quality single towels help prevent waste and cross-contamination

TOWEL-CFOLD

2400/Case C-Fold \$30.29/cs

Professional Towel Tissue/Poly

These standard tissue/poly towels catch fluid and hold it, making them ideal for washing, wiping or draping. They combine durability with disposability. 13" x 19"

TOWEL-TP 13" X 19" 2-Ply 500/cs \$22.95/cs

TOWEL-TPT 13" X 19" 3-Ply 500/cs \$29.95/cs

Professional Towel

Designed to be soft and gentle yet strong and durable. 13" X 19", 3 ply, 500/cs

TOWEL-P 13" X 19" 3-Ply 500/cs \$22.99/cs

Nye Model Tourniquet

This tourniquet features a quick release metal clip which can be unlocked using one hand. Ideal for IV applications. Strap will not roll or pinch. Tension can be released or applied at will. Instantly removed by depressing the button. It is very durable and can withstand repeated use and sterilization. Can also be used as a canine muzzle.

JOR130 Nye-Model \$8.70/ea
JOR130R Spare Rubber for Nye Tourniquet \$3.00/ea

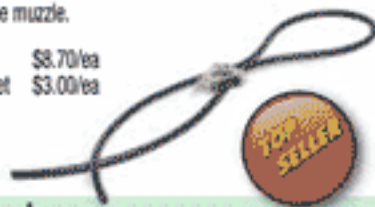

Nylon Tourniquet

This tourniquet looks so simple but it works! Nylon elastic cord has a better stretch with a tighter fit. It is easier to tighten and release with one hand. Plastic clasp holds tough with no slipping. Inexpensive. Blister packaged in pairs.

JOR605 Pair of 2 \$6.15/pr



Quick Release Tourniquet

This new tourniquet has a quick release at the flick of a button. One hand can hold the syringe, the other can release the tourniquet. Broad blue band of stretch elastic gives a very tight fit.

JOR130X Quick Release \$24.00/ea



Enema Solution 4.5 Oz

Solutions are pre-bottled and ready to use. Anatomically correct tips are pre-lubricated for a safe and relaxed insertion. Protective shields help to prevent contamination. One-way safety valve controls flow and helps prevent reflux. Convenient round squeeze bottle is easy to hold.

ENEMA 4.5oz \$0.85/ea



Exam Penlight

These lightweight pens provide a high-intensity light in a durable casing and can be easily clipped to pockets.

PLITE 6/Pkg \$8.25/pk



13822 WEST BOULTON BLVD. METTAWA, IL 60045

Phone 800-544-7521

125

WWW.SHOPMEDVET.COM

Fax 800-204-2177

Surgical and Exam Supplies

Surgical Instruments, Surgical Mesh & Animal Microchips

Utility Bandage Scissors



| Vendor | Item# | Details | Price |
|------------------|----------|---------|------------|
| ECONOMY | 3-169 | 5.5" | \$3.95/ea |
| | 3-170 | 7.5" | \$3.95/ea |
| MID GRADE | 02-109 | 7.5" | \$7.00/ea |
| MILTEX | MLS-1000 | 7.5" | \$21.51/ea |
| | MLS-998 | 6.5" | \$21.51/ea |

Lister Bandage Scissors



| Vendor | Item# | Details | Price |
|----------------|---------|---------|------------|
| ECONOMY | 2-120 | 3.5" | \$2.95/ea |
| | 2-125 | 4.5" | \$2.95/ea |
| | 2-130 | 5.5" | \$2.95/ea |
| | 2-145 | 7.5" | \$3.95/ea |
| GERMAN | 02-100 | 3.5" | \$18.00/ea |
| | 02-101 | 4.5" | \$18.00/ea |
| | 02-102 | 5.5" | \$18.00/ea |
| | 02-103 | 7.5" | \$18.00/ea |
| MILTEX | MLS-510 | 3.5" | \$50.63/ea |
| | MLS-512 | 4.5" | \$52.58/ea |
| | MLS-516 | 7.25" | \$81.70/ea |

Spencer Stitch Scissors



| Vendor | Item# | Details | Price |
|----------------|---------|---------|------------|
| ECONOMY | 4-360 | 3.5" | \$2.95/ea |
| GERMAN | 02-112 | 3.5" | \$17.00/ea |
| MILTEX | MLS-100 | 3" | \$69.61/ea |

Taylor Hammer



| Vendor | Item# | Details | Price |
|----------------|---------|--------------|-----------|
| ECONOMY | 11-1275 | Chrome, 7.5" | \$3.95/ea |

AKC Companion Animal Recovery Microchips

AKC Companion Animal Recovery Microchips can be purchased with prepaid enrollment or your clients can enroll themselves. The chips can be read by most universal scanners. AKC CAR microchip enrollment benefits your clients, and is straightforward and includes:

- One time enrollment fee, no annual fees.
- AKC CAR Collar ID Tags.
- 24/7 support from dedicated recovery experts.
- No charge to update records, or limit to the number of updates made.
- Low tag replacement costs.

| | | |
|-------------|--------------------------------------|--------------|
| AKC-10MC | 10 chips/box | \$129.00/box |
| AKC-10MCPPE | 10 chips/box with prepaid enrollment | \$219.00/box |
| AKC-20MC | 20 chips/box | \$239.00/box |

| | | |
|-------------|---|--------------|
| AKC-20MCPPE | 20 chips/box with prepaid enrollment | \$399.00/box |
| AKC-IMP | Implanter | \$23.95/ea |
| AKC-PS700 | Proscan 700 Universal Scanner (Scans all chips) | \$320.00/ea |

Leighton Bone Pin Introducer

designed to help reduce overriding fractures and facilitate insertion of the intramedullary pin into the distal segment of a fracture.

JOR158 (see illustration for explanation of use) \$170.00/ea



Left Curved Hoof Knife



| Vendor | Item# | Details | Price |
|------------------|----------|----------------|------------|
| JORGENSEN | JOR32HWL | 5/8"W x 2.75"L | \$30.90/ea |

Swiss Knife

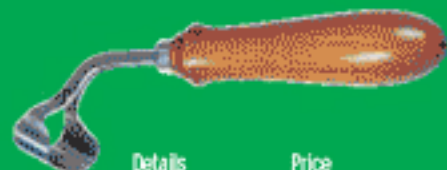

| Vendor | Item# | Details | Price |
|------------------|--------|---------|------------|
| JORGENSEN | JOR32E | 7.25" | \$27.50/ea |

Left Curved Hoof Knife



| Vendor | Item# | Details | Price |
|------------------|--------|---------|-----------|
| JORGENSEN | JOR32P | each | \$1.50/ea |

Polyester Surgical Mesh

Surgical mesh is useful to repair soft tissue defects such as perineal and umbilical hernias. Mesh loop diameter 1mm.

JOR1054 60mm (2.4") x 80mm (3.2"). Sterile 1/pk. \$34.00/ea

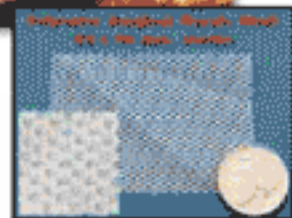

Surgical and Exam Supplies

Stainless Steel, Exam Table Paper & Blades



Graduated Measures Cup (A)

| | | |
|--------|----------------------|------------|
| 49-355 | 3 3/4" x 4 5/8" 16oz | \$24.45/ea |
| 49-356 | 4 3/4" x 4 1/4" 32oz | \$33.65/ea |

Iodine Cup (B)

| | | |
|--------|----------------------|-----------|
| 49-341 | 3 7/16" x 2" 6 oz | \$3.96/ea |
| 49-342 | 4 3/8" x 2 5/8" 14oz | \$8.15/ea |

Medicine Cup (C)

| | | |
|--------|-----------------|-----------|
| 49-343 | 2 1/8" x 2" 2oz | \$4.20/ea |
|--------|-----------------|-----------|

Ointment Jar With Handle (D)

| | | |
|--------|---------------------|------------|
| 49-348 | 3 1/8" x 2 3/4" 9oz | \$17.00/ea |
|--------|---------------------|------------|

Solution Bowl (E)

| | | |
|--------|-----------------------|------------|
| 49-389 | 13 5/8" x 4 5/8" 7 qt | \$44.53/ea |
|--------|-----------------------|------------|

Sponge Bowl (F)

| | | |
|--------|------------------------|------------|
| 49-383 | 4 1/4" x 2" 12oz | \$7.00/ea |
| 49-385 | 5 9/16" x 2 9/16" 29oz | \$9.90/ea |
| 49-386 | 6 1/4" x 2 3/4" 36oz | \$13.90/ea |
| 49-387 | 7 9/16" x 3" 64oz | \$22.50/ea |
| 49-346 | 1" x 4" | \$13.50/ea |

Catheter and Instrument Tray with Flat Cover (G)

| | | |
|--------|---------------------------|------------|
| 49-361 | 12 1/4" X 7 3/4" X 2 1/4" | \$38.25/ea |
|--------|---------------------------|------------|

Dressing Jar (H)

| | | |
|--------|-------------------------------------|------------|
| 49-333 | 4 1/8" X 2 1/4" With Cover 1/2 Qt. | \$15.58/ea |
| 49-334 | 4 1/8" X 5 1/2" With Cover 1-1/4 Qt | \$19.13/ea |
| 49-335 | 4 1/8" X 6 1/4" With Cover 1-7/8 Qt | \$27.63/ea |

Emesis Basin (I)

| | | |
|--------|-------------------------------|------------|
| 49-380 | 9 7/8" x 4 1/2" x 2 1/4" 26oz | \$14.52/ea |
| 49-381 | 6 5/8" x 3 1/2" x 1 1/2" 10oz | \$7.90/ea |
| 49-382 | 8 1/8" x 3 5/8" x 1 5/8" 12oz | \$11.33/ea |

Forceps Jar (J)

| | | |
|--------|-------------|------------|
| 49-351 | 2 1/4" X 7" | \$22.30/ea |
|--------|-------------|------------|

Tumbler (K)

| | | |
|--------|---------------------|-----------|
| 49-344 | 2 7/8" x 3 1/8" 7oz | \$5.90/ea |
|--------|---------------------|-----------|

Instrument or Spay Pack Tray

| | | |
|---------|--|------------|
| JOR399B | Top: 12" x 7 3/4" x 1 15/16", Bottom: 10 1/2" x 6 1/4" x 2" | \$33.75/ea |
|---------|--|------------|

Exam Table Paper

Exam Table Paper: Medline's absorbent table paper protects exam tables from dirt and moisture while offering comfort and protection for patients. Choose from smooth or crepe finish (crepe is softer, quieter and more absorbent). Crepe is also more textured which will help prevent it from sliding on surfaces. All rolls are mechanically metered for exact length, and individually poly bagged for cleanliness during shipment and storage. White. 2/Case

| | | |
|----------|-------------------|---------|
| NON23322 | Smooth 18" x 225' | \$51.96 |
| NON25325 | Smooth 21" x 125' | \$31.13 |
| NON25326 | Smooth 21" x 225' | \$52.19 |
| NON25324 | Crepe 18" x 125' | \$28.72 |
| NON23324 | Crepe 18" x 125' | \$30.50 |
| NON23325 | Crepe 21" x 125' | \$33.65 |

Exam Table Paper (Deluxe)

| | | |
|----------|-------------------|---------|
| NON23326 | Smooth 21" x 225' | \$55.00 |
|----------|-------------------|---------|



Jorvet Sterile Swann-Morton Scalpel Blades

Made from the finest carbon steel. Sizes stocked: 10, 11, 12, 15, 20, 21, and 22. These sharp blades are the result of years of experience plus modern production methods. Individually wrapped. 100/pkg.

| Item# | Details | Price |
|---------|------------------|-------------|
| JOR54SA | size 10, 100/box | \$28.50/box |
| JOR54SC | size 12, 100/pkg | \$28.50/box |
| JOR54SE | size 20, 100/pkg | \$28.50/box |
| JOR54SG | size 22, 100/pkg | \$28.50/box |
| JOR54SB | size 11, 100/pkg | \$28.50/box |
| JOR54SF | size 21, 100/pkg | \$28.50/box |

Thermal Reflective Blanket

| | | |
|------|--------------------|----------|
| 3537 | 84 x 52", 120/case | \$120.00 |
|------|--------------------|----------|



See Our Equipment Section for a Complete List of Stainless Steel Products

Swann-Morton Disposable Scalpel

Sizes 10, 11, 12, 15, 21 and 22. 10/box. Sterile



| | | |
|---------|------------------|------------|
| JOR55DA | size #10, 10/box | \$9.90/box |
| JOR55DB | size #11, 10/box | \$9.90/box |
| JOR55DC | size #12, 10/box | \$9.90/box |
| JOR55DD | size #15, 10/box | \$9.90/box |
| JOR55DE | size #20, 10/box | \$9.90/box |
| JOR55DF | size #21, 10/box | \$9.90/box |

13822 WEST BOULTON BLVD. METTAWA, IL 60045

Phone 800-544-7521



WWW.SHOPMEDVET.COM

Fax 800-204-2177

Cardio Link, Excision Kit & Warming Units/Beds

Jorvet The Cardio Link

The Cardio Link is an esophageal cable with four stainless ECG electrodes built in the distal end. It can be linked to all brands of existing ECG monitors. The ECG clips are placed on metal knobs inside a control box. This small box helps protect the clips and prevents interference. Just select Lead II on your ECG machine after proper positioning inside the esophagus after the patient is intubated, and then watch the QRS waveform. The Cardio Link gets rid of cumbersome leads running to all four legs. Three different sizes are available and all will work with the one control box.

Leads available:

- Green lead 12fr (4mm) x 36" long cats, exotics, small dogs
- Blue lead 18fr x 42" long cats, dogs
- Red lead 18fr x 100" long horses

| | | |
|------------------------|--|-------------|
| JOR851E | EKG catheter 18fr X 100" red, long red lead for horses. Cable only | \$192.00/ea |
| JOR851Q | EKG Green lead 12fr (4mm) x 36" long cats, exotics, small dogs | \$300.00/ea |
| JOR851R | EKG Blue lead 18fr x 42" long cats, dogs | \$300.00/ea |
| Esophageal Kits | | |
| JOR851T | Cardio-Link Esophageal kit w/two 12fr leads | \$300.00/ea |
| JOR851W | Cardio-Link Esophageal kit w/two 18fr leads | \$300.00/ea |



Jorvet



Jorvet Warming Airbag

Warming Air Blankets. Keeping patients warm during surgery and recovery has always been a challenge. Electric pads have a risk of overheating, circulating water blankets are easily damaged. Our new warm air blankets are a safe, economical solution to this problem. They are made of a silky polyester fabric with an inlay of nylon water proof material to keep the airflow circulating upward towards the patient. These blankets are machine washable (hang to dry) therefore much more economical than other air blankets on the market, which are disposable. There is a 5" diameter round opening with a nylon cord to secure the blanket to any of the major brands of warm air convection units.

Jorvet

| | | |
|----------|-------------------|-------------|
| JOR1034 | Small, 30" x 20" | \$43.00/ea |
| JOR1034A | Medium, 36" X 24" | \$48.00/ea |
| JOR1034B | Large, 48" X24" | \$52.00/ea |
| JOR1034S | Set of 3 | \$131.00/ea |

Disposable Warming Blanket

One side has nylon reflective coating, the other (patient) side is SMS material. Light blue.

| | | |
|----------|-------------------|----------|
| JOR1034F | 27" x 34", 10/pk. | \$165.00 |
|----------|-------------------|----------|

Cloud 9 Warming unit

2 temperature settings: 100°F and 110°F
5 feet flexible clear connecting hose
Dimensions 12.5" w x 12" d x 11.25" h
Weights 10.5 lbs

- Uses 110v AC power
- 2 year limited warranty (not on blankets or filters)
- Quiet operation
- Filtration 0.3 micron high-efficiency filter
- Includes set of 3 different reusable warming blankets (JOR1034s)

| | | |
|----------|---|-------------|
| JOR1034X | 100v-120v 50-60hz, (220v units available) | \$990.00/ea |
|----------|---|-------------|



Jorvet AbsorbENT™ Ear Wick

Ear wicks have been around a long time in human medicine. Recent improvements have made them a valuable adjunct to treating otitis externa for veterinarians. AbsorbENT™ sponges consist of interconnected open cells that are extremely soft and pliable. The interconnected cell structure produces a packing that is exceptionally strong, highly absorbent and virtually lint and fiber free. AbsorbENT™ is designed as an aid in the treatment of otitis externa. When liquid medication is applied to the sterile, compressed sponge, it gently and evenly expands to fill the ear canal dispersing the medication and applying gentle pressure to the tissue.

- Expands rapidly for effective distribution of liquid medication
- Soft, pliable sponge enhances patient comfort while applying gentle pressure
- Compressed and sterile for rapid patient treatment
- Suture can be placed around the end for easy retrieval

Suggested use: Insert Ear Wick and infuse appropriate antibiotic or corticosteroid into sponge. Leave in place for up to a WEEK!! The resulting reduction in edema or swelling will cause Ear Wick to come out easily.

| | | |
|----------|--------------------------------------|-------------|
| JOR1084 | 9mm (diameter) x 15mm (length) 50/pk | \$99.00/pk |
| JOR1084A | 9mm (diameter) x 24mm (length) 50/pk | \$132.00/pk |

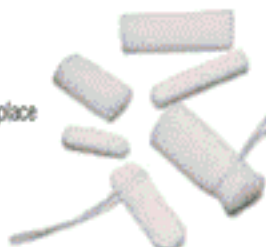

Jorvet Anal Sac Excision Kit

The anal sac excision kit employs a warm liquefied gel injected in to the sac. The gel is in a 2ml cartridge that is first heated to a liquid and loaded in a specially designed syringe. Then, via a 19g blunt needle, is injected into each anal sac. The gel then hardens and gives the sac a readily defined and easily dissected shape for quick removal. Each kit has enough material to do up to eight animals

| | | |
|--------|---|------------|
| JOR101 | JOR101d#1 Metal Breech Loading Syringe. | \$63.00/ea |
| | JOR101d#2 Gel Vials. 8 x 2ml.* | |
| | JOR101d#3 Blunt Needles. 8 x 19g.* | |

8 gel cartridges

| | | |
|----------|---------------------|------------|
| JOR101D2 | Gel Vials. 8 x 2ml. | \$18.60/pk |
|----------|---------------------|------------|

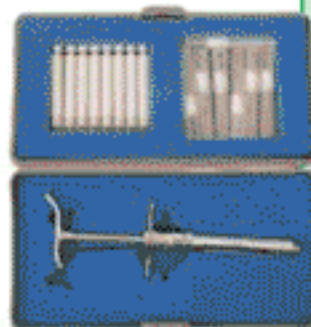

Snugglesafe Heat Pad

This plate-size heatpad will provide up to 12 hours of safe, gentle warmth after being heated in a microwave. No electric wires to worry about. The heat retaining compound inside the pad is non-toxic and environmentally friendly. Also great for whelping puppies.

| | | |
|----------|---|------------|
| BCS21200 | This plate-size heat pad will provide up to 12 hours of safe, gentle warmth after being heated in a microwave. No electric wires to worry about. The heat retaining compound inside the pad is non-toxic and environmentally friendly. Also great for whelping puppies. | \$34.95/ea |
|----------|---|------------|



Chlorhexidine Solution

| | | |
|--------------|------------|------------|
| RXCHLOR2-GAL | 2%, gallon | \$19.99/gl |
|--------------|------------|------------|

Chlorhexidine Scrub/Solution

| | | |
|--------------|------------|------------|
| RXCHLOR4% | 4%, gallon | \$36.99/gl |
| RXCHLOR4%-16 | 4%, 16oz | \$5.87/btl |



Feeding/Stomach Tubes

Jorvet Silicon Gastric Feeding Tube

- Bullet point/cap for luer fitting
- Lateral eye along numerous spots (4)
- Graduated marking
- Can be used long term
- Sterile

| | | |
|---------|---------------------------|-----------|
| JOR385 | 8fr. 2.7mm O.D. x 70cm. | \$8.40/ea |
| JOR385A | 12fr. 4.0mm O.D. x 120cm. | \$8.40/ea |
| JOR385B | 16fr. 5.3mm O.D. x 120cm. | \$9.15/ea |
| JOR385C | 20fr. 7.3mm O.D. x 120cm. | \$9.00/ea |



Jorvet Silicon Nasogastric Feeding Tube

These silicone feeding tubes are great for administering medication and other fluids orally or nasally. All catheters are fully autoclavable. Lateral eyes are on distal tip. Hinged-attached cap.

| | | |
|---------|---------------------------------|------------|
| JOR386 | 3.5fr O.D. 1.3mm O.D. 20cm L. | \$45.00/ea |
| JOR386A | 5.0fr O.D. 1.7mm O.D. 20cm L. | \$44.80/ea |
| JOR386B | 5.0fr O.D. 1.7mm O.D. 35cm L. | \$27.00/ea |
| JOR386C | 6.0fr O.D. 2.0mm O.D. 55cm L. | \$27.00/ea |
| JOR386D | 8.0fr O.D. 2.7mm O.D. 40cm L. | \$30.00/ea |
| JOR386E | 8.0fr O.D. 2.7mm O.D. 55cm L. | \$44.80/ea |
| JOR386F | 8.0fr O.D. 2.7mm O.D. 75cm L. | \$18.60/ea |
| JOR386G | 8.0fr O.D. 2.7mm O.D. 120cm L. | \$33.00/ea |
| JOR386H | 10.0fr O.D. 3.3mm O.D. 40cm L. | \$20.70/ea |
| JOR386J | 10.0fr O.D. 3.3mm O.D. 55cm L. | \$49.00/ea |
| JOR386K | 10.0fr O.D. 3.3mm O.D. 150cm L. | \$36.00/ea |
| JOR386M | 14.0fr O.D. 4.7mm O.D. 120cm L. | \$49.00/ea |



Silicon Stomach Feeding Tube **JorVet**

Stomach Feeding Tubes for small and large animals. These silicone stomach tubes are for cats and dogs; larger sizes are designed for equine or other large animal use. Constructed of clear tubing with hinged double proximal cap which allows either attaching a luer syringe or standard catheter fitting. Also features an openended single luer and distal lateral eyes. Fully autoclavable.

| | | |
|---------|---|-------------|
| JOR385E | 14fr O.D. 3.0mm I.D. 4.7mm O.D. 91cm (36") L. | \$53.20/ea |
| JOR385F | 18fr O.D. 4.0mm I.D. 6.0mm O.D. 91cm (36") L. | \$42.00/ea |
| JOR385G | 24fr O.D. 5.0mm I.D. 8.0mm O.D. 18cm (7") L. | \$26.50/ea |
| JOR385J | 24fr O.D. 5.0mm I.D. 8.0mm O.D. 91cm (36") L. | \$54.30/ea |
| JOR385M | 35fr O.D. 6.0mm I.D. 11.7mm O.D. 300cm (120") L. | \$70.00/ea |
| JOR385N | 57fr O.D. 11.0mm I.D. 19.0mm O.D. 300cm (120") L. | \$73.00/ea |
| JOR385P | 73fr O.D. 17.0mm I.D. 24.0mm O.D. 300cm (120") L. | \$123.20/ea |



Portex Equine Stomach Tube **JorVet**

This is the finest quality tube on the market. Made from special siliconized PVC tubing, it has just the right amount of flexibility; it won't become rigid in cold weather and will not soften or kink in hot weather. Each tube has a funnel end to make attachment to a drench pump quick and easy.

| | | |
|---------|--|------------|
| JOR106F | Foal, 1/4"H x I.D. 3/8"H x O.D. x 7"L. | \$49.50/ea |
| JOR106S | Small, 5/16"H x I.D. 1/2"H x O.D. x 9"L. | \$57.00/ea |
| JOR106L | Large, 1/2"H x I.D. 3/4"H x O.D. x 10"L. | \$86.00/ea |
| JOR106M | Medium, 3/8"H x I.D. 5/8"H x O.D. x 9"L. | \$57.00/ea |



Jorvet Stomach Tubes

Canine

Larger size PVC stomach tube for bigger dogs. Useful in gastric lavage or administering larger volumes of fluids with special funnel adaptor. Plus has one lateral eye.

| | | |
|--------------------|--|-------------------------------|
| JOR348Q | Medium, 1/4"H I.D. x 3/8"H O.D. x 31/2". | \$15.00/ea |
| For dogs > 40 lbs. | | |
| JOR348R | Large, 5/16"H I.D. x 1/2"H O.D. x 4". | For dogs < 70 lbs. \$18.90/ea |

Equine

End just slightly expanded to fit stomach pumps and dose syringes better. Manufactured from the same superior grade of material as the familiar Portex brand tubes, yet in comparison, about 1/3 the cost, or comparable to standard PVC tubes.

| | | |
|----------|---|------------|
| JOR106MG | Medium Equine, 3/8" I.D. x 5/8" O.D. x 9' L | \$42.00/ea |
|----------|---|------------|

E-Z Swallow Equine Stomach Tube **JorVet**

With no funnel end, just slightly expanded to fit stomach pumps and dose syringes better. Manufactured from the same superior grade of material as the familiar Portex brand tubes, yet in comparison, about 1/3 the cost, or comparable to standard PVC tubes.

| | | |
|----------|--|------------|
| JOR106FG | Foal, 1/4"H x I.D. 3/8"H x O.D. x 7"L. | \$36.00/ea |
| JOR106SG | Small, 5/16"H x I.D. 1/2"H x O.D. x 9"L. | \$33.00/ea |
| JOR106LG | Large, 1/2"H x I.D. 3/4"H x O.D. x 10"L. | \$46.50/ea |



SAVE UP TO 70% OFF
SINGLE SUTURE FOR TEACHING/TRAINING
SUTUREDIRECT.COM

Enteral Feeding Products **JorVet**

This line of products is especially designed for mid-long term enteral feeding. Features of polyurethane feeding tubes: More durable and longer lasting than PVC tubes; Weighted tip with metal tungsten guide end for ease of placement and retention; Stylets included on all sizes; Radiopaque and non-sterile; Many of these tubes will move by peristaltic action to the jejunum after placement in the stomach, which requires longer lengths than standard feeding tubes; Numerical graduations on side of the tube; and complete directions come with the product.

| | | |
|---------|-----------------------------------|------------|
| JOR350A | 5Fr x22" (56cm) (no weighted tip) | \$15.00/ea |
| JOR350B | 6Fr x22" -weighted tip | \$22.50/ea |
| JOR350C | 6Fr x36" -weighted tip | \$22.50/ea |
| JOR350D | 8Fr x22" (no weighted tip) | \$22.50/ea |
| JOR350E | 8Fr x36" -weighted tip | \$22.50/ea |
| JOR350F | 8Fr x43" -weighted tip | \$24.00/ea |
| JOR350G | 10Fr x36" -weighted tip | \$24.00/ea |
| JOR350H | 10Fr x43" -weighted tip | \$25.50/ea |
| JOR350J | 10Fr x55" -weighted tip | \$27.00/ea |
| JOR350K | 12Fr x43" -weighted tip | \$25.50/ea |



Stomach Tube Speculum & Gastronomy Applicator

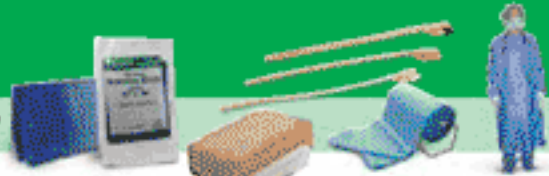

Canine Stomach Tube **JorVet**

Designed to facilitate the removal or location of esophageal obstructions. The rounded ends allow for atraumatic passage while the metal ball marker assists in the location of any obstruction by X-ray methods. The lateral eye allows for aspiration of gastric contents or administration of fluids. This item is a great addition to any veterinary clinic.



| | | |
|---------|-------------|------------|
| JOR106A | 24ft x 76cm | \$24.00/ea |
| JOR106B | 36ft x 76cm | \$24.60/ea |



Small Animal Nasogastric Feeding Tube **JorVet**

These small animal feeding tubes are useful in longer term nasogastric oral supplementation. Transparent plastic. Rounded closed tip with two opposing lateral eyes. Luer syringe connector with attached plug. Sterile. 5/pkg.



| | | |
|---------|--------------------------|------------|
| JOR348A | 5ft x 15". Cat and dogs. | \$12.60/ea |
| JOR348B | 8ft x 15". Medium dogs. | \$12.60/ea |
| JOR348C | 5ft x 39". | \$12.60/ea |
| JOR348D | 8ft x 42". | \$12.60/ea |

Small Animal Feeding Tube

Red latex rubber with two opposing lateral eyes. X-ray opaque. Sterile. Improved over red vinyl tubes because it is bio-compatible and allows more patient comfort with less rigidity. Can be reused and reautoclaved. 40cm (16"). 5/pkg. **JorVet**



These tubes work well with the JOR51k-n stomach tube speculums.

| | | |
|----------|------------|------------|
| JOR347CC | Tube, 14ft | \$9.60/bpk |
| JOR347A | Tube, 8ft | \$9.60/bpk |
| JOR347B | Tube, 10ft | \$9.60/bpk |
| JOR347C | Tube, 12ft | \$9.60/bpk |



EquiVet Large Volume Funnel

A large, over-sized funnel with a special barbed fitting that attaches firmly to stomach tubes.

| | | |
|---------|------------|---------------|
| JOR106X | \$36.90/ea | JorVet |
|---------|------------|---------------|



Medical Grade Silicone Elastomer Tube

This tubing can be used for a variety of clinical purposes including drains and feeding tubes. Autoclavable. Radiopaque marking. 50cm L.



| | | |
|---------|-----------------------|-----------|
| JOR523A | 8mm I.D. x 10mm O.D. | \$7.50/ea |
| JOR523B | 10mm I.D. x 12mm O.D. | \$3.75/ea |



EquiVet Polyurethane Stomach **JorVet**

These all weather tubes give a little more stiffness with longer length for easy passing into the esophagus. The proximal end of the tube has a flared tip especially designed to attach to the standard metal stomach pump's barbed fittings. The distal tip is highly polished.



| | | |
|----------|-------------------------------------|------------|
| JOR106FX | Foal, 9mm O.D. x 2.60m (8 3/8")L | \$40.50/ea |
| JOR106SX | Small, 13mm O.D. x 3.2m (10 1/4")L | \$43.50/ea |
| JOR106LX | Large, 19mm O.D. x 3.6m (11 1/2")L | \$63.00/ea |
| JOR106MX | Medium, 16mm O.D. x 3.6m (11 1/2")L | \$55.75/ea |

Canine Stomach Tube Speculum

Speculum is useful for passing stomach tube in the conscious patient. The speculum is held in check by the canine teeth going through the two large holes. A 3/8" round hole through the center allows a stomach tube to pass through. By holding jaws firmly closed any chance of biting the tube is eliminated. The hardened blue nylon resists chewing and can be cold sterilized for reuse. 9mm opening. **JorVet**

| | | |
|--------|-------|-----------|
| JOR51M | 27ft. | \$8.25/ea |
|--------|-------|-----------|



Large Canine Stomach Tube Speculum

Large Canine Stomach Tube Speculum. 6" x 2" will take up to a 3/8" stomach tube.

| | | |
|--------|---------|-----------|
| JOR51N | 6" x 2" | \$8.25/ea |
|--------|---------|-----------|



Feline Stomach Tube Speculum

Smaller size works well on cats and smaller dogs. 6mm opening. **JorVet**

| | | |
|--------|-------|-----------|
| JOR51K | 18ft. | \$8.25/ea |
|--------|-------|-----------|



Esophagostomy Feeding Tube

Tubes for long term placement of esophagostomy tubes.

- Soft silicone
- Bio compatible
- Luer fitting
- Retention cap always attached
- Cut to desired length
- Non-sterile
- Packaged individually in chevron pouch



| | | |
|---------|-------|-----------|
| JOR390L | Large | \$7.95/ea |
|---------|-------|-----------|



PVC Stomach Tube

Inexpensive standard PVC stomach tubes with funnel end.

| | | |
|----------|---|------------|
| JOR106FE | Foal, 1/4"H x I.D. 3/8"H x O.D. x 7"L | \$24.75/ea |
| JOR106LE | Large, 1/2"H x I.D. 3/4"H x O.D. x 10"L | \$30.00/ea |
| JOR106ME | Medium, 3/8"H x I.D. 5/8"H x O.D. x 9"L | \$30.00/ea |
| JOR106SE | Small, 5/16"H x I.D. 12"H x O.D. x 9"L | \$24.00/ea |

Esophagostomy Tube Insertion Device

This line of products is especially designed for mid-long term enteral feeding. Features of polyurethane feeding tubes: More durable and longer lasting than PVC tubes; Weighted tip with metal tungsten guide end for ease of placement and retention; Stylets included on all sizes; Radiopaque and non-sterile; Many of these tubes will move by peristaltic action to the jejunum after placement in the stomach, which requires longer lengths than standard feeding tubes; Numerical graduations on side of the tube; and Complete directions come with the product. **JorVet**

| | | |
|---------|---|-------------|
| JOR1083 | Includes 10 tubes 15ft x 50cm, DVD available. | \$260.00/ea |
|---------|---|-------------|



ELD Gastrostomy Tube Applicator

Percutaneous gastrostomy nutritional supplementation is an easy and practical way to feed an anorexic cat or dog. With the advent of special diets like Hill's Prescription AD and other syringeable diets, many previously terminal cases can be saved. However, until now, the only way to place a gastrostomy tube properly was with the aid of a fiberoptic endoscope. JorVet introduces the ELD Applicator that allows the percutaneous insertion of a gastrostomy feeding tube.

| | | |
|---------|------------------------------------|-------------|
| JOR389 | For cats and small dogs. 18" shaft | \$144.00/ea |
| JOR389L | For large dogs. 32" shaft | \$156.00/ea |

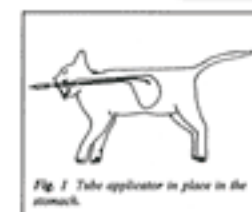

Fig. 1 Tube applicator in place in the stomach.

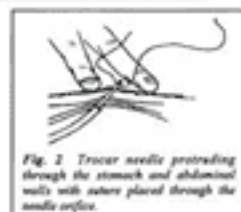

Fig. 2 Trocar needle protruding through the stomach and abdominal walls with suture placed through the needle orifice.

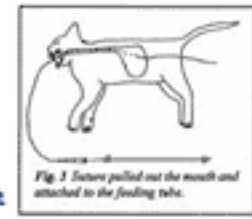

Fig. 3 Sutures pulled out the mouth and attached to the feeding tube.



Fig. 4 Feeding tube placed through the abdominal wall illustrating the two anchor pieces being stabilized by the two rubber bands.

Esophageal Stethoscope Wound Drainage



Esophageal Stethoscope

Attaches to standard stethoscope

| | | |
|---------|----------------|------------|
| JOR205A | 12fr. 20" long | \$19.20/ea |
| JOR205B | 18fr. 20" long | \$19.20/ea |
| JOR205C | 24fr. 20" long | \$19.20/ea |



Silicon Chest Drainage Tube

Multifenestration with black numbered markings at 2 and 4cm from proximal hole. It has an opened end. White color. Proximal end can be trimmed to desired length.



| | | |
|---------|-------------------------------|------------|
| JOR524C | O.D. 12fr (4mm) I.D. 2.2mm | \$33.60/ea |
| JOR524D | O.D. 14fr (4.67mm) I.D. 2.5mm | \$33.60/ea |
| JOR524E | O.D. 20fr (6.67mm) I.D. 4.0mm | \$35.00/ea |
| JOR524F | O.D. 30fr (10mm) I.D. 7.0mm | \$35.00/ea |

Closed Wound Drainage Kit

This vacuum drain's most common use is for post-op drainage Jackson Pratt. The kit is designed to create suction or negative pressure for draining wounds. A fenestrated silicone drain is placed into position with the aid of a stainless steel trocar. This drain is attached to a silicone bulb with a one-way valve. When the bulb is released a vacuum is created that pulls exudates out through the drain. Wound exudates can be stored, visualized, or cultured. The drain has a radio-opaque line for the entire length.

The kit consists of: a 130mm stainless steel trocar, silicone fenestrated drain and tubing, a silicone bulb and a clamp for attachment to bandage or patient.



Ewe Prolapse Retainer

Vaginal prolapse. Does not interfere with lambing and can be left in place for extended periods.

JOR26E \$4.50/ea



Protection Tube for Uterine Biopsy Forceps

This protective tube is passed through the cervix. A biopsy forceps is then passed through it to avoid any contamination on the biopsy sample.

JOR116A O.D. 15mm x 40cm length \$66.00/ea



Uterine Lavage Kit

This extra large bore semi-rigid clear pipette has a very high flow. Sterile. 1/4" x 25" L.

- Dual 60° fluid line with spike on one end
- Shut-off clamps on each side of "Y"

JOR286 w/ "Y" tubing \$11.70/ea

Gastric Lavage Kit

A kit designed for use in common gastric emergency conditions where quick and effective lavage or flushing of the stomach is required, (e.g. gastric dilatation volvulus and acute poisonings). The kit includes 3 large bore semi-rigid lavage tubes and a stomach irrigation system that connects to any faucet.

Kit contains:

- (3) Semi-rigid polyethylene tubes
- 1" I.D. x 11/4" O.D. 48" L.
- 7/8" I.D. x 1" O.D. 42" L.
- 5/8" I.D. x 3/4" O.D. 36" L.
- Dura clamp to prevent backflow
- Reducing clamp
- Faucet adaptor
- PVC tubing 3/8" I.D. x 1/2" o.d. x 100cm
- Stomach tube with metal X-ray marker



JOR115 23cm x 76cm. \$63.00/ea



Jorvet Y Barb Connector

"Y" Barbed Connector.

| | | |
|---------|-----------|-----------|
| JOR596 | 8mm, 2/pk | \$7.35/pk |
| JOR596A | 4mm, 2/pk | \$6.90/pk |



Uterus Pump

JOR27P \$39.00/ea



Silver-Plated Metal Tracheostomy Tube 3-Piece Kit (Canine)

German-made. Kit includes:

- Bulb shaped obturator
- Inner cannula for easy cleaning
- Outer cannula with wide outer plate for secure attachment (i.e., umbilical tape)

| | | |
|---------|-----------|------------|
| JOR143A | 4mm O.D. | \$52.00/ea |
| JOR143B | 8mm O.D. | \$51.00/ea |
| JOR143C | 10mm O.D. | \$54.00/ea |
| JOR143D | 12mm O.D. | \$51.00/ea |

Esophagostomy Tube Replacement

Tube only for Esophagostomy Tube insertion device. One tube.

JOR1083T 15fr x 50cm. Each.



Flexi-drain Multi-Purpose Wound Drain

A silicone tubular drain that may be trimmed, peeled away, or used as a whole piece for surgical wound drainage. The drain can be split along its length or trimmed to suit individual requirements. Autoclavable. 40cm L drain of 12-3mm dia. catheters.

JOR524G \$7.50/ea

Laser Replacement Parts & Cold Therapy System

Jorvet Laser Consumable or Replacement Parts

For use with the AccuVet LX-20 CO2 Laser System, Jorvet offers these commonly needed parts for the operation of the CO2 Laser. These parts are warranted to be identical in quality to any factory part. All laser tips are compatible with Luxar LXH-ST, LXH-TL, LXHA105, and LX-AH Handpieces. Non-sterile.

| | | |
|---------|---|-------------|
| JOR941B | Ceramic Laser Tip, 10mm x 0.4mm. (Equivalent to the Luxar LXT-010SS metal tip) Offers the ability to do narrower incisions and apply increased power density at higher output than metal. It has a longer life and handles higher power more safely than metal tips. Small spot size. Single tip. One green ring (0.40mm) spot size indication. | \$16.00/ea |
| JOR941C | Ceramic Laser Tip, 10mm x 0.2mm. (Equivalent to the Luxar LXT-010SS metal tip) Offers the smallest available tip for very fine incisions. Handles 20W power. Extra small spot size. Single tip. Two green ring (0.20mm) spot size indication. | \$16.00/ea |
| JOR941 | Ceramic Laser Tip, 5mm. (Luxar #C5) Shorter tip for tight access applications. 0.8mm spot size. 5/pk. | \$23.00/pk |
| JOR941A | Ceramic Laser Tip, 10mm. (Luxar #C10) Versatile tip for most applications. 0.8mm spot size. 5/pk. | \$27.00/pk |
| JOR941X | Laser large spot tip 1.4mm, New larger size for ablation and hemostasis. 1.4mm x 5mm length. Aluminum material. | \$27.50/ea |
| JOR941P | Gold mirror | \$78.00/ea |
| JOR941M | Straight Handpiece, Tip securing collet design and ergonomic handle, for less price. (Luxar #LXH-ST, LXH-TL). 5" length. | \$170.00/ea |
| JOR941N | Angled handpiece, (Luxar #LX-AH) 105° angle. Improved comfort by design. 5" length | \$178.00/ea |

CO2 Laser System Kit

Includes:

- Straight handpiece (JOR941m)
- Angled handpiece (JOR941n)
- Gold mirror (JOR941p)
- Removal tool
- 3 ceramic laser tips, 5mm x 0.8mm. (JOR941)
- 3 ceramic laser tips, 10mm x 0.8mm. (JOR941a)
- Ceramic laser tip, 10mm x 0.4mm. (JOR941b)
- Ceramic laser tip, 10mm 0.2mm. (JOR941c)

JOR941K \$395.00/ea

NEW

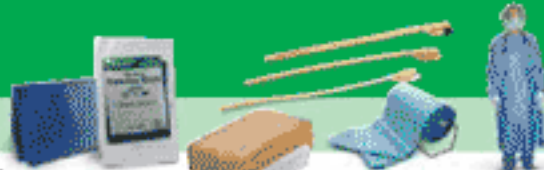

Jorvet Calf Drencher

Collapsible 2 1/2-liter bag with special rigid probe. 3-track water-tight closure aids easy filling. Rigid top portion with holes for easy handling or hanging. On/off flow clamp. Special cold temperature-resistant plastic will not crack. Round ball-shaped end aids proper placement. Graduated markings in both liters and quarts.

JOR138 REORDABLE, EA \$14.40/ea

Silicone Bulb Evacuators

Silicone Bulb Evacuators Provide Constant, Effective Suction to Help Reduce Occlusion. Designed specifically for smaller procedures where less exudate is anticipated.

DYNJWE1000 Silicone Bulb Evacuator, 400cc Capacity \$18.21/ea
DYNJWE1305 Silicone Bulb Evacuator, 100cc Capacity \$8.05/ea



Jorvet Complete Cold Therapy System

The benefits of cold and compression in post-surgical care have long been known. These benefits include minimizing hemorrhosis and swelling. Cold will also reduce postoperative pain. The immediate use after surgical repair of orthopedic procedures such as cruciate or fracture repair is an indication. New surgical procedures such as TPLO respond nicely to this mode of treatment. The Jorvet Portable Cold Therapy System continuously pumps cold water through hoses connected to a soft pad held in place by Velcro straps. Water and ice are put into the cooler reservoir. Temperatures can be set at three ranges to insure therapeutic level of cold:

Cool: 45-55°F (7-13°C)
Cold: 40-50°F (4-10°C)
Coldest: 35-45°F (2-7°C)

Features:

- Not gravity dependent, will pump at or below the level of the pad
- Electronic pump is mounted outside the cooler reservoir, not affecting speed of ice melt
- Provides up to 10 hours of continuous and effective cold therapy
- Veterinary specific protocol included

System includes 21" x 11" (31cm x 28.5cm) therapy pad with straps.

JOR923 Weight, with pads 6.25 lbs. (2.84 kg) \$285.00/ea

Therapy Pad

JOR923P 0.25 lbs. (0.12 kg) \$47.60/ea



Avian Restraint

Auspex Avian Restrainer

Extremely easy to use! Simply fold the flat restrainer to form a truncated cone shape, and rapidly place over the bird. Most birds pop out the smaller opening of the restrainer. The restrainer is indispensable for various treatments, including examinations, administering oral medication or food, injections, working with legs, feet, or clipping nails.

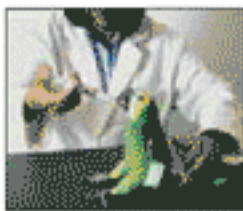

| | | |
|---------|--|------------|
| JOR381A | Small. Canaries, budgies, cockatiels | \$6.75/ea |
| JOR381B | Medium. Conures, small Amazons | \$8.10/ea |
| JOR381C | Large. Amazons, African greys, and small cockatoos | \$9.60/ea |
| JOR381D | X-Large. Macaws and moluccan cockatoos | \$14.10/ea |
| JOR381S | Set of 4 | \$37.50/pk |

Jorvet Avian Adhesive Drape

The preferred drape for smaller animals where visualizing your anatomic landmarks is critical. Large enough for cats and small dogs.

Clear plastic material

- 5" x 5" square area of adhesive to adhere to animal
- Individually wrapped in sterile, easy open header pack

| | | |
|----------|-------------------------|------------|
| JOR259K | 44" x 44" 5 pk, sterile | \$26.40/pk |
| JOR259KS | 24" x 24" 5 pk, sterile | \$19.50/pk |



Avian Positioner

Auspex Avian Positioner is used to position an avian species for radiography and surgery. The Positioner is made of a piece of durable plexiglass board. There are two short slots and four longer slots machined through the board. Several pieces of strategically-placed velcro hook type fasteners are permanently attached to the bottom of the board. Several straps of loop type velcro are supplied, which are utilized for restraining the bird's and wings. Several pairs of the velcro face straps, used to restrain the bird's legs, are also included. The versatile Auspex Avian Positioner can be applied to most types of birds, from budgerigars to macaws. It is highly effective and reliable, able to securely restrain even the most unruly bird. It is safe and relatively painless, since the bird is held using soft cloth-like straps, unlike the gullotine-type devices that hold the bird's neck down with a piece of hard plastic. The Positioner is low-cost and durable. It is hygienic, easy to clean and sterilize. The wing restraint is a novel feature, useful for radiography. The board has raised feet at the four corners to allow for placement of heating pads under it, when desired. Positioner is low-cost and durable. It is hygienic, easy to clean and sterilize. The wing restraint is a novel feature, useful for radiography. The board has raised feet at the four corners to allow for placement of heating pads under it, when desired.



| | | |
|---------|------------|------------|
| JOR381P | 18"W x 18" | \$51.00/ea |
|---------|------------|------------|

Biopsy Embedded Cassettes

Small biopsy samples can get lost in a formalin jar and must be 'fished out'. These biopsy cassettes hold and contain the sample while it is immersed into a formalin jar. The sample can then be processed at the histopath lab through their automated equipment right in these cassettes. Orange. 50/pk. Needs to be at least a 60ml formalin jar to fit cassette.

| | | |
|---------|----------------|------------|
| JOR1049 | Orange. 50/pk. | \$22.00/ea |
|---------|----------------|------------|

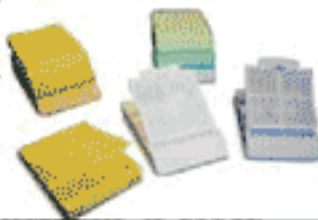

Perivaginal Tape,

To be used according to the Dr. Buhner method for treatment of a prolapse of the uterus or vagina. This special woven oval-shaped tape has histophilic features that permit a heal-in without irritation. Directions for use upon request. 4.5 meters.

| | | |
|-------|-----|------------|
| JOR25 | 5m. | \$15.70/ea |
|-------|-----|------------|

Buhner Needle

For use with JOR25 tape.

| | | |
|-------|---------------------|------------|
| JOR26 | Stainless steel 12" | \$19.50/ea |
|-------|---------------------|------------|

Gerlach Needle

For use in sheep and goats.

| | | |
|--------|---|------------|
| JOR26G | Similar to JOR26, but only 6"L. Similar to JOR26, but only 6"L. | \$16.50/ea |
|--------|---|------------|



OB Shoulder Cuff

Basically the same as JOR29 above, but less area is covered. Very handy in conjunction with disposable or rubber sleeves.

| | | |
|--------|-------------------|------------|
| JOR29C | Heat-sealed seams | \$33.00/ea |
|--------|-------------------|------------|

OB Shoulder Protector

This is the original Danish import, where the arm passes through an opening in the special easy-to-clean rubber shield. There's no bunching of the material in the arm area. If worn in conjunction with a rubber apron, it serves as an OB smock. Protector lies under opposite arm.

| | | |
|-------|-------------------|------------|
| JOR29 | Heat-sealed seams | \$45.00/ea |
|-------|-------------------|------------|

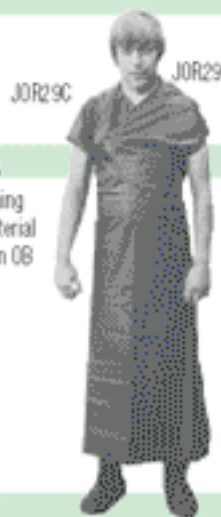

See our Scrub & Apparel section for a full listing of OB Rubberized coverings

Jorvet Sterile OB Lube-Vet Label

This small sterile lube packet is great for lubing up a vaginal speculum or anywhere a small amount of sterile lube is required, especially OB work. Non-spermiocidal. Easy open 1 oz. packet 12/case.

| | | |
|--------|------------|------------|
| JOR781 | 1 oz., dz. | \$11.40/dz |
|--------|------------|------------|



Jorvet Silicone Wound Drain

Traditional Style 100% Silicone Wound Drains Provide Effective Drainage. Smooth, heat polished perforations are positioned in alternate 90 degree planes for effective exudates drainage. Drain placement is quick and easy thanks to the convenient indicator dot. Available in various round and flat sizes. Radiopaque.

| | | |
|-------------|--|-----------|
| DYNJWE1323A | DRAIN, 15F, 3/16, End Perforation | \$7.82/ea |
| DYNJWE1309 | 10 mm x 20 cm, 3/4 Perforation, ea | \$8.05/ea |
| DYNJWE1311 | 10 mm x 20 cm, 3/4 Perforation, ea | \$8.28/ea |
| DYNJWE1321A | 10F, 1/8, End Perforation | \$7.82/ea |
| DYNJWE1308A | Drain, 7 mm x 20 cm, 3/4 Perforation, ea | \$8.28/ea |
| DYNJWE1310 | 7 mm x 20 cm, Full Perforation, ea | \$8.28/ea |
| DYNJWE1320 | 7F, 3/32", End Perforation | \$7.82/ea |
| DYNJWE1325A | 19F, 1/4, End Perforation | \$7.82/ea |

Jorvet Stainless Steel Thoracic Drain

| | | |
|---------|-------------------------------------|------------|
| JORS24M | 12tr (JORS24c) O.D. 1.3mm I.D. 40cm | \$15.00/ea |
| JORS24N | 14tr (JORS24d) O.D. 2.3mm I.D. 40cm | \$15.00/ea |
| JORS24P | 20tr (JORS24e) O.D. 3.2mm I.D. 40cm | \$16.50/ea |
| JORS24Q | 30tr (JORS24f) O.D. 4.7mm I.D. 40cm | \$18.00/ea |

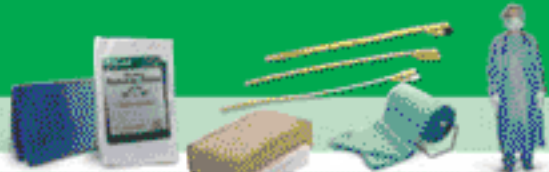

Jorvet Silicone Thoracic Drain

Straight with X-ray opaque line with an open end. Graduated depth markings. Six smooth oval lateral eyes. Autoclavable. 50cm L.

| | | |
|---------|-------------|-----------|
| JOR524 | 16fr. 5.3mm | \$7.20/ea |
| JOR524A | 20fr. 6.7mm | \$7.20/ea |
| JOR524B | 24fr. 8.0mm | \$7.50/ea |



Safe 'n Warm Exam Table Mat



Safe 'n Warm Foam Mat. Post-op patient comfort is simple and easy with these foam padded mats. The core is constructed of thick foam for cushion and comfort. Seamless coating eliminates accumulation of dirt or debris. Totally non-absorbent; allows easy cleaning with standard hospital disinfectants. Just wipe clean with a paper towel. The mat reduces hypothermia, unlike cold stainless steel or metal grate surfaces that drain body heat. Lightweight and portable, can be moved from location to location.

- Fits inside standard cages (i.e., Shor-Line and Suburban)
- Slight bevel tips fluid towards drainage
- Especially valuable for post-op comfort
- Fits on top of wall-mount or pedestal-type exam tables (i.e., Shor-Line and Suburban). Length just short of drain hole.

| | | |
|--------|------------------|-------------|
| JOR766 | 20" x 44" x 1/2" | \$236.00/ea |
|--------|------------------|-------------|

Safe 'n Warm Surgery Table Mat



Safe 'n Warm Foam Mat. Post-op patient comfort is simple and easy with these foam padded mats. The core is constructed of thick foam for cushion and comfort. Seamless coating eliminates accumulation of dirt or debris. Totally non-absorbent; allows easy cleaning with standard hospital disinfectants. Just wipe clean with a paper towel. The mat reduces hypothermia, unlike cold stainless steel or metal grate surfaces that drain body heat. Lightweight and portable, can be moved from location to location.

- Fits inside standard cages (i.e., Shor-Line and Suburban)
- Slight bevel tips fluid towards drainage
- Especially valuable for post-op comfort
- Fits on top of standard stainless steel surgery tables (i.e., Shor-Line and Suburban). Length just short of drain hole.

JOR766

| | | |
|---------|-----------------------|-------------|
| JOR767 | Short. 15" x 40" x 1" | \$206.00/ea |
| JOR767A | Long. 15" x 50" x 1" | \$276.00/ea |

JOR767 & JOR76A

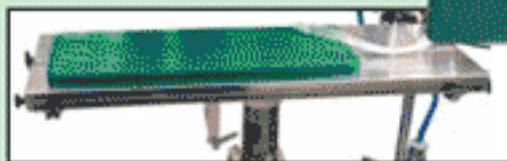

Safe 'n Warm Scrub Sink Mat

Fits on top of standard metal grate style scrub sinks (i.e., Shor-Line or Suburban).

| | | |
|---------|-----------------------|-------------|
| JOR768 | Short. 20" x 30" x 1" | \$206.00/ea |
| JOR768A | Long. 20" x 44" x 1" | \$294.00/ea |



What about the veterinarian or the staff? Long hours of standing on hard floors during surgery or even in the reception area can develop leg and back soreness. These comfortable mats also work for people. Tapered or beveled edges for safety.

| | | |
|---------|-----------------------|-------------|
| JOR769 | 19" x 38" x 2" | \$302.00/ea |
| JOR769A | Large. 29" x 38" x 2" | \$402.00/ea |

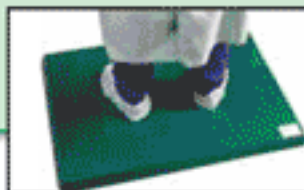

Uro-Collect System



The "Uro-Collect" system was developed as an easy-touse and convenient kit for collecting a noncontaminated and diagnostic urine sample in either the clinic or at the owner's home. 12/pk.

Kit includes:

- Litter pan liner
- 4.5-5 oz. polypropylene beads
- Reclosable bag
- Twist ties
- Complete client instructions

| | | |
|--------|-------|------------|
| JOR165 | Dozen | \$67.00/dz |
|--------|-------|------------|



Jorvet Lab Litter



FLUTD, or feline lower urinary tract disease, is a common problem in the feline patient. Obtaining high quality urine samples is a must to ensure proper diagnosis and treatment, plus as a follow-up evaluating treatment results. Lab Litter™ is a clear, non-absorbent, small plastic granule that feels like cat litter to the feline patient. It's used to help collect urine samples.

| | | |
|---------|-----------------------|------------|
| JOR164A | Dispensing pack/dozen | \$45.00/dz |
|---------|-----------------------|------------|



Lab Litter Beads

| | | |
|----------|----------|------------|
| JOR165D1 | 5 Pounds | \$60.50/ea |
|----------|----------|------------|



Jorvet Urine Collection Bag

Urine collection bag, smaller version of JOR1027 bag.

- 600ml capacity
- Anti reflux drain
- Bottom drains through twist open/close valve
- Two straps: one on top and one on bottom
- Top drain is tiered to fit catheter i.e. Foley
- Sterile fluid pathway



| | | |
|----------|-------|-----------|
| JOR1027A | 600ml | \$3.15/ea |
|----------|-------|-----------|

NEW



Jorvet Urine Drainage Bag

Monitoring urine output is an important aspect in treating critically ill renal patients. These bags are a polyethylene material. They are transparent on one side and the opposite is white.

- 2000ml capacity with graduations
- Inflow connector is a tapered fitting that to a catheter (i.e. Foley) for a secure leak proof fit.
- Tubing is 11/32" X 50" cm length
- Universal double hook: can hang on cage
- Needle free sampling port
- Anti Reflux drip chamber: minimizes the risk of infection
- Additional clip can attach tubing to patients hair or fur
- Sterile fluid pathway

| | | |
|---------|--------|-----------|
| JOR1027 | 2000ml | \$6.00/ea |
|---------|--------|-----------|





Restraints - Economy Collars, Saf-T-Clear & Elizabethan

Economy Collar

Elizabethan-type economy budget collars. Perfect for dogs, cats and other small animals. Lightweight. White opaque polyethylene.

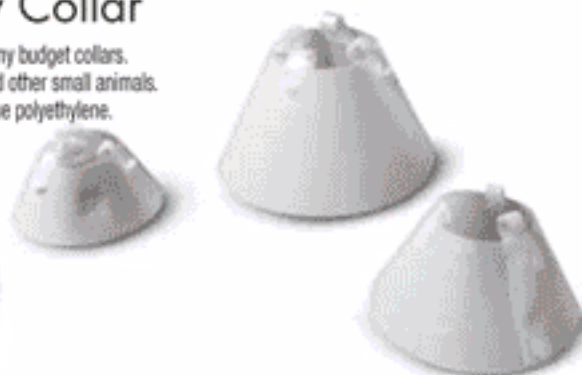

TOP SELLER

| | | | |
|--------|-------------|-----------|--------------|
| EC7.5 | Size 7 1/2 | \$1.75/ea | 10+\$1.50/ea |
| EC10 | Size 10 | \$2.00/ea | 10+\$1.75/ea |
| EC12.5 | Size 12 1/2 | \$2.25/ea | 10+\$2.00/ea |
| EC15 | Size 15 | \$2.50/ea | 10+\$2.25/ea |
| EC20 | Size 20 | \$2.75/ea | 10+\$2.50/ea |
| EC25 | Size 25 | \$3.25/ea | 10+\$3.00/ea |
| EC30 | Size 30 | \$3.75/ea | 10+\$3.50/ea |

Saf-T-Shield Collar

Saf-T-Shield collar prevents patient from aggravating a healing wound. It was designed for long term clinic/hospital use. This collar is recommended for post-operative protection of ear, eye, abdomen, and foot. Has a easy snap closure and a adjustable fit.

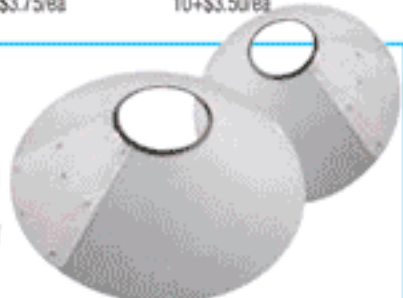

| | | |
|--------|---|------------|
| EJ412 | 12" Diameter, 6" - 8.25" Neck Circumference | \$6.50/ea |
| EJ412S | 12" Diameter, 5.5" - 6.5" Neck Circumference | \$6.50/ea |
| EJ415 | 15" Diameter, 6.25" - 8.5" Neck Circumference | \$7.99/ea |
| EJ418 | 18" Diameter, 10" - 13.5" Neck Circumference | \$8.99/ea |
| EJ418S | 18" Diameter, 6.5" - 9" Neck Circumference | \$8.99/ea |
| EJ424 | 24" Diameter, 10.75" - 14.5" Neck Circumference | \$11.50/ea |
| EJ424S | 24" Diameter, 9.25" - 12.25" Neck Circumference | \$11.50/ea |
| EJ430 | 30" Diameter, 13.75" - 18" Neck Circumference | \$14.99/ea |
| EJ430S | 30" Diameter, 11.25" - 15" Neck Circumference | \$14.99/ea |
| EJ436 | 36" Diameter, 21" - 27" Neck Circumference | \$19.99/ea |
| EJ436S | 36" Diameter, 13.5" - 18" Neck Circumference | \$19.99/ea |

Saf-T-Clear Collar

Made from a clear, durable material providing five neck circumference adjustment point. Allows patient to maintain full peripheral vision. Padded neck area for comfort as is the outside rim. Eight sizes available, from puppies to large breed dogs.

NEW



| | | |
|---------|---|------------|
| EJCL625 | Clear, 9.25" Width, 15.25"-20" Neck Circumference | \$7.43/ea |
| EJCL415 | Clear, 7" Width, 11.25"-14.75" Neck Circumference | \$5.43/ea |
| EJCL175 | Clear, 3.50" Width, 7"-8.25" Neck Circumference | \$4.03/ea |
| EJCL210 | Clear, 4.50" Width, 7"-9.50" Neck Circumference | \$4.28/ea |
| EJCL312 | Clear, 5" Width, 9.25"-12" Neck Circumference | \$4.55/ea |
| EJCL520 | Clear, 8" Width, 13"-17" Neck Circumference | \$6.13/ea |
| EJCL840 | Clear, 16" Width, 25"-31" Neck Circumference | \$13.91/ea |

Recova-Clear Recovery Collar

Ideal for kittens, adult felines & small breed puppies. Patient retains peripheral vision & is resilient enough to allow patient to lie down & sleep. No drawstring.



| | | |
|--------|---|-----------|
| EJRC3 | Clear, Recovery, 8.50" Width, 15"-18" Neck Circumference | \$9.91/ea |
| EJRC4 | Clear, Recovery, Collar, 2 RCX0, 3 RC0, 3 RC1, 1 RC2, 1 RC3 | \$0.00/ea |
| EJRC2 | Clear, Recovery, 7" Width, 10"-14", Neck Circumference | \$8.91/ea |
| EJRCX0 | Clear, Recovery, 4" Width, 4.50"-7", Neck Circumference | \$4.41/ea |
| EJRC0 | Clear, Recovery, 4" Width, 7.50"-10", Neck Circumference | \$4.83/ea |
| EJRC1 | Clear, Recovery, 6" Width, 9"-12.50", Neck Circumference | \$6.50/ea |

Clear Elizabethan Collar

Comfortable, easy to apply collars made from clear, lightweight, resilient material. Does not impair patients vision. Increased neck circumference adjustment points allows for correct, comfortable fit. Available in 8 sizes to fit small breed dogs up to great danes!



| | | |
|----------|---|------------|
| EJCK12.5 | 9" - 12.5", Neck Circumference, 5" collar depth | \$3.00/ea |
| EJCK7.5 | 8.5" - 10.5", Neck Circumference, 3.5" collar depth | \$2.70/ea |
| EJCK10 | 8.5" - 10.5", Neck Circumference, 4.375" collar depth | \$2.81/ea |
| EJCK15 | 12" - 16", Neck Circumference, 6" collar depth | \$3.90/ea |
| EJCK20 | 13.5" - 17", Neck Circumference, 8" collar depth | \$4.20/ea |
| EJCK25 | 15" - 19.5", Neck Circumference, 10" collar depth | \$5.10/ea |
| EJCK30 | 17" - 22.5", Neck Circumference, 12" collar depth | \$5.70/ea |
| EJCK40 | 24" - 31", Neck Circumference, 16" collar depth | \$12.00/ea |

Saf-T-Shield Collar Research Laboratory Animals



| | | |
|-----------|---|-----------|
| EJRC403V | 1.25" Diameter, 2.25" - 3" Neck Circumference | \$3.98/ea |
| EJRCM | 1.25" Diameter, 1" - 1.25" Neck Circumference | \$3.98/ea |
| EJRC404VS | 1.50" Diameter, 2.25" - 3" Neck Circumference | \$3.98/ea |
| EJRC404VL | 1.125" Diameter, 3" - 4", Neck Circumference | \$3.98/ea |

Flea & Tick Control



See our Pharmaceutical Section



Buster Dog Collar

Buster disposable protective collars for dogs and cats—an ideal and inexpensive solution. **Material:** Made of lightweight flexible plastic. Will not annoy patient during rest since its flexibility will yield to the shape of the head. Endures pushing without getting deformed, even in cold weather.

Application: Easy to fit on the patient. The collar is closed without use of difficult tapes and strings. Its size can be adjusted according to the size of the patient's head, and fastened to the patient's collar by the straps.

Sizes: Available in 8 sizes with adjustments from 7cm to 20cm neckhole. Each collar has 2 to 3 possible adjustments. Each collar has size marked on it. One size 10/pk, or set of 8 sizes.

| | | |
|--------|---|-------------|
| JOR46A | 10 pack, #7.5cm Length, 13" - 15" Opening, 7" - 8" Neck Hole | \$22.10/pk |
| JOR46B | 10 pack, #10cm Length, 15" - 18" Opening, 7" - 8" Neck Hole | \$25.65/pk |
| JOR46G | 10 pack, #12.5cm Length, 18" - 20" Opening, 10" - 12" Neck Hole | \$31.35/pk |
| JOR46C | 10 pack, #15cm Length, 20" - 22" Opening, 10" - 12" Neck Hole | \$34.20/pk |
| JOR46D | 10 pack, #20cm Length, 22" - 24" Opening, 12" - 14" Neck Hole | \$37.05/pk |
| JOR46E | 10 pack, #25cm Length, 24" - 26" Opening, 15" - 17" Neck Hole | \$48.45/pk |
| JOR46F | 10 pack, #30cm Length, 26" - 28" Opening, 17" - 20" Neck Hole | \$54.00/pk |
| JOR46J | 35cm, 10/pk | \$96.00/pk |
| JOR46S | Set of 7 sizes | \$28.50/set |

Stainless Steel Dog Collar Rack

| | | |
|--------|---|-------------|
| JOR46R | With pegs for all seven sizes. Offers a handy way to display the collars as well as store them. | \$101.00/ea |
|--------|---|-------------|

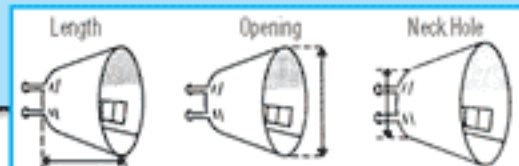

Cervical Collars

A comfortable & easy-to-use alternative to the Elizabethan collar. Allows pet to eat, drink, sleep, play, run up stairs & around corners & even sit on laps. With these collars, your pet's peripheral vision is unimpeded making them calmer & happier. Collars are made of flexible plastic & are secured by Velcro®, elastic wrap-around strap & harness strap, which wraps around your pet's chest.

| | | |
|--------|--------------------------------|------------|
| EJBF1 | 2.5" W, 16" Neck Circumference | \$11.83/ea |
| EJBF2 | 3.5" W, 18" Neck Circumference | \$12.70/ea |
| EJBF2A | 4" W, 21" Neck Circumference | \$11.93/ea |
| EJBF3 | 5" W, 25" Neck Circumference | \$12.39/ea |
| EJBF4 | 6" W, 27" Neck Circumference | \$14.74/ea |
| EJBF5 | 7" W, 28" Neck Circumference | \$15.73/ea |
| EJBF6 | 8" W, 32" Neck Circumference | \$17.37/ea |



Clear Collar

Clearcollar™ Elizabethan Restraint Collars for cats and dogs. These collars have two major features not found in similar products currently available to veterinarians:

- The transparency feature is a substantial advantage for the patient in that it allows peripheral vision. Owners also seem to prefer transparent rather than opaque collars because they are far less conspicuous and appear to be more "humane."
- The second major feature is a set of small plastic clips designed to make it quick and easy to apply and remove the collar repeatedly. The collar also has three sets of loops for a more secure attachment either by weaving gauze or heavy cord through the loops and tying the ends in a bow, or by tying the loops to the pet's collar. Clearcollar™ restraint collars are available in six sizes, and each collar has five sets of adjustment holes to permit proper fitting of most patients. 10/box.

| | | |
|---------|-------------|--------------|
| JOR500A | 12", 10-pk. | \$59.85/box |
| JOR500B | 15", 10-pk. | \$64.10/box |
| JOR500C | 18", 10-pk. | \$68.40/box |
| JOR500D | 24", 10-pk. | \$85.50/box |
| JOR500E | 30", 10-pk. | \$108.00/box |
| JOR500F | 38", 10-pk. | \$133.95/box |
| JOR500S | Set of 6 | \$64.10/box |



Plastic clips, 20 pk.
JOR500PC \$6.60/ea

Buster Aural Hematoma Pad

Aural hematomas are a common clinical case. A pocket of blood develops a separation between the inside skin of the ear and the ear cartilage. Surgical treatment is directed towards restoring that skin to cartilage bond.

| | | |
|-------|---------|-----------|
| JOR47 | Sterile | \$4.50/ea |
|-------|---------|-----------|





Restraints - Collars & Neck Braces

Buster Neck Brace

From the designers of the original Buster collar the Buster Neck Brace leaves the patient's head largely free and thus supports its natural mobility.

- Comfortable: Light weight polyethylene with a closed-cell foam lining
- Good Ventilation: Plenty of holes ensure good air flow
- Easy Application: Two snaps lock in place and can adjust to any size. The collar can be trimmed with a scissors for better fitting.

JOR609D X-Large \$8.25/ea

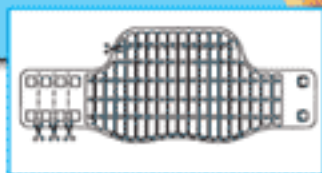

Plastic Bird Collar

Clear plastic bird collars. Made of durable plastic material. Easy to assemble and requires only a few staples to secure in place.

| | | |
|----------|----------------|-------------|
| JOR468CA | 10 pack, 8 cm | \$12.00/pk |
| JOR468CB | 10 pack, 10 cm | \$12.00/pk |
| JOR468CC | 10 pack, 14 cm | \$15.00/pk |
| JOR468CD | 10 pack, 20 cm | \$24.00/pk |
| JOR468CS | Set of 4 | \$15.00/set |

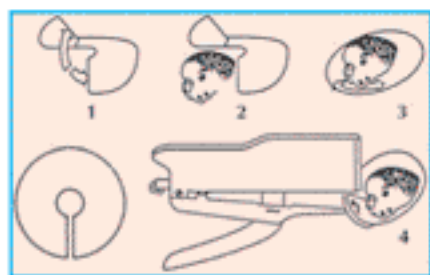
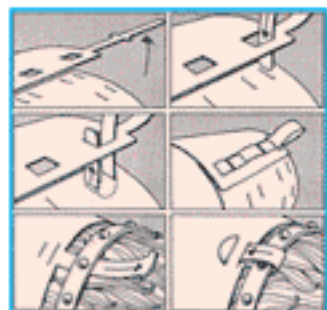

Buster Nylon Basket Muzzle

Clear plastic bird collars. Made of durable plastic material. Easy to assemble and requires only a few staples to secure in place.

| | | |
|---------|---|-------------|
| JOR884A | Size #2, Yorkshire Terrier, Papillon, etc.. | \$4.50/ea |
| JOR884B | Size #3, Bichon Frise, etc. | \$5.70/ea |
| JOR884C | Size #4, Jack Russell, Border Terrier, Whippet, etc. | \$6.00/ea |
| JOR884D | Size #5, Corgi, Fox Terrier, King Charles Spaniel, etc. | \$6.60/ea |
| JOR884E | Size #6, Beagle, Border Collie, Cocker Spaniel, etc. | \$8.70/ea |
| JOR884F | Size #7, Dalmation, Springer Spaniel, Samoyed, etc. | \$9.00/ea |
| JOR884G | Size #8, Airdale, Chow Chow, English Setter, etc. | \$10.20/ea |
| JOR884H | Size #9, Gordon Setter, Weimaraner, etc. | \$10.50/ea |
| JOR884J | Size #10, Great Dane, New Foundland, etc. | \$10.50/ea |
| JOR884M | Size #12 Boxer/Rottweiler, etc. | \$12.00/ea |
| JOR884S | Set of all | \$87.00/set |



Saf-T-Shield Collar Lightweight

Saf-T-Shield collar prevents patient from aggravating a healing wound. It was designed for long term clinic/hospital use. This collar is recommended for post-operative protection of ear, eye, abdomen, and foot. Has a easy snap closure and an adjustable fit.



| | | |
|---------|---|-----------|
| EJ408LS | Lightweight, 8" Diameter, 2.75" - 4" Neck Circumference | \$5.38/ea |
| EJ410LS | Lightweight, 10" Diameter, 3.75" - 5.25" Neck Circumference | \$6.03/ea |
| EJ406L | Lightweight, 6" Diameter, 3" - 3.25" Neck Circumference | \$4.65/ea |
| EJ408L | Lightweight, 8" Diameter, 4" - 5" Neck Circumference | \$5.38/ea |
| EJ410L | Lightweight, 10" Diameter, 5.50" - 7.25" Neck Circumference | \$6.03/ea |
| EJ412LS | Lightweight, 12" Diameter, 5.25" - 7" Neck Circumference | \$6.68/ea |
| EJ412L | Lightweight, 12" Diameter, 7.25" - 10" Neck Circumference | \$6.68/ea |
| EJ406LS | Lightweight, 6" Diameter, 2.50" - 3.25" Neck Circumference | \$4.65/ea |

Avian Plexiglass Collar

Lightweight and rigid protective collar. Clear plexiglass. Uses two set screws (included).

| | | |
|---------|-------|------------|
| JOR740 | 3.5cm | \$31.50/ea |
| JOR740L | 4.5cm | \$60.00/ea |



Bird Collar

These bird collars are made of tough, pliable, lightweight material with tight-snap fasteners. Neck opening is padded to ensure comfort.

| | | |
|---------|--|-----------|
| EJ404X | 4" Shield Diameter, 1.4" - 2.0" Neck Opening Circumference | \$4.99/ea |
| EJ406XS | 6" Shield Diameter, 2.0" - 2.7" Neck Opening Circumference | \$5.99/ea |
| EJ406X | 6" Shield Diameter, 2.7" - 3.5" Neck Opening Circumference | \$5.99/ea |
| EJ408XS | 8" Shield Diameter, 3.2" - 3.5" Neck Opening Circumference | \$6.50/ea |
| EJ408X | 8" Shield Diameter, 3.5" - 4.0" Neck Opening Circumference | \$6.50/ea |
| EJ410XS | 10" Shield Diameter, 3.5" - 4.0" Neck Opening Circumference | \$6.99/ea |
| EJ410X | 10" Shield Diameter, 4.7" - 5.5" Neck Opening Circumference | \$6.99/ea |
| EJ412XS | 12" Shield Diameter, 4.7" - 5.5" Neck Opening Circumference | \$7.50/ea |
| EJ412X | 12" Shield Diameter, 6.25" - 7.5" Neck Opening Circumference | \$7.50/ea |



Pet, Grooming & Restraints

Restraints - Collars; Buster Clic & Soft -E- Collar



Buster Clic Collar

Jorvet

New quick and simple "click" closing system. Makes the application of the collar as easy as buttoning your shirt. Fully transparent material, environmentally friendly 100 percent polypropylene. The newly developed material allows the animal all-around vision and animals can avoid walking into furniture, etc. Soft and flexible. Easy to apply to patient. Available in 8 sizes plus combo pack. 10/box.

| | | |
|--------|-----------------|-------------|
| JOR47A | 10 pack, #7.5 | \$27.00/pk |
| JOR47B | 10 pack, #10 | \$27.00/pk |
| JOR47C | 10 pack, #15 | \$39.00/pk |
| JOR47D | 10 pack, #20 | \$42.00/pk |
| JOR47E | 10 pack, #25 | \$51.30/pk |
| JOR47F | 10 pack, #30 | \$57.00/pk |
| JOR47G | 10 pack, #12.5 | \$31.35/pk |
| JOR47H | 10 pack, #40 | \$132.00/pk |
| JOR47J | 35cm, 10pk | \$108.00/pk |
| JOR47S | Set of 7, (A-G) | \$36.00/bx |



Jorvet Foam Collar

Jorvet

A safe and comfortable support for the neck of dogs and cats. It will also restrict movement of the head, thereby protecting other parts of the body from self-inflicted trauma. The Foam Collar is made from an ultralight, dense and rigid closed-cell foam. The collar is black, with both sides being an easily cleaned "skin". Application of the Foam Collar is simple. It is wrapped around the neck and held in place with one or two pieces of standard adhesive tape. It has no sharp edges, and the ends can be trimmed to an exact custom fit. Six different widths are available to accommodate most dogs and cats. To size for proper fit, measure from just behind the ear to the top bony portion of the shoulder.

| | | |
|---------|----------------|------------|
| JOR610A | 3" x 15", 5pk | \$19.50/pk |
| JOR610B | 4" x 18", 5 pk | \$21.00/pk |
| JOR610C | 5" x 21", 5 pk | \$24.00/pk |
| JOR610D | 6" x 24", 5 pk | \$27.00/pk |
| JOR610E | 7" x 28", 5 pk | \$31.50/pk |
| JOR610F | 8" x 32", 5 pk | \$34.50/pk |
| JOR610S | Set of 6 | \$39.00/pk |



Jorvet Soft-E-Collar™

Jorvet

The use of Elizabethan Collars is widespread in veterinary medicine. There have been a multitude of different designs over the years. Traditional "E" collars have tried to balance the comfort of the patient versus the effectiveness of the "E" collar. The Soft-E-Collar™ was designed first and foremost for the comfort of the patient, yet it still is effective in offering licking and chewing protection. Clients like the attractive pattern along with the comfortable foam padding. Pets can move about freely without damaging furniture, and are able to eat and drink more freely than with traditional collars. The Soft-E-Collar™ is a waterproof heavy nylon material that covers a soft foam doughnut-shaped ring. It is held in place by a strong, flat tie.

| | | |
|----------|--|--------------|
| JOR1003A | XX-small, Weight 2.1, Diameter 8, Center Adjustable 1 7/8", Cat/Dog up to 5 lbs. | \$10.95/ea |
| JOR1003B | X-small, Weight 2.6, Diameter 9 1/4", Center Adjustable 2 3/4", Cat/Dog 5 - 9 lbs. | \$12.15/ea |
| JOR1003C | Small, Weight 3.2, Diameter 10 3/4", Center Adjustable 4", Cat/Dog 10 - 14 lbs. | \$12.75/ea |
| JOR1003D | SS-Medium, Weight 7.0, Diameter 14", Center Adjustable 4 1/2", Cat/Dog 15 - 20 lbs. | \$15.75/ea |
| JOR1003E | Small/Medium, Weight 7.0, Diameter 16 1/2", Center Adjustable 5", Dog 20 - 30 lbs. | \$19.20/ea |
| JOR1003F | Medium, Weight 11.3, Diameter 19", Center Adjustable 6", Dog 30 - 55 lbs. | \$22.20/ea |
| JOR1003G | Large, Weight 14.0, Diameter 23 1/2", Center Adjustable 7 3/4", Dog 55 - 75 lbs. | \$24.90/ea |
| JOR1003H | X-Large, Weight 19.0, Diameter 27 1/2", Center Adjustable 7 1/4", Cat/Dog 75 - 95 lbs. | \$28.50/ea |
| JOR1003J | XX-Large, Weight 22.0, Diameter 31 1/2", Center Adjustable 7 1/4", Dog over 90 lbs. | \$30.90/ea |
| JOR1003S | Set of All 9 sizes | \$155.00/set |



Jorvet Leather Muzzle

Leather Muzzle. High quality, thick-grained leather with heavy-duty rivets. More reliable and safer than canvas or gauze muzzles. Five sizes available for Yorkshire Terriers to Great Danes. One size also especially designed for cats and brachycephalic breeds.

| | | | | | |
|---------|---------|------------|---------|---------------------------|-------------|
| JOR230A | X-Small | \$27.00/ea | JOR230E | X-Large | \$36.00/ea |
| JOR230B | Small | \$27.75/ea | JOR230F | Brachycephalic and Feline | \$31.75/ea |
| JOR230C | Medium | \$29.10/ea | JOR230S | Set of 6 | \$180.00/ea |
| JOR230D | Large | \$31.50/ea | | | |



13822 WEST BOULTON BLVD. METTAWA, IL 60045

WWW.SHOPMEDVET.COM

Phone 800-544-7521

138

Fax 800-204-2177



Restraints - Muzzles

Nylon Muzzle

These high-quality water resistant nylon muzzles come in a variety of sizes and have a quick release snap. An expanded line of quick-release muzzles.

- Safety Muzzles fit securely with quick-adjust straps for a snug fit.
- Comfort: Lightweight nylon feels and looks more professional than gauze roll.
- Quality: Reinforced stitching to assure long-lasting use.
- MZSET Also sold as a convenient starter set with savings discount: MU0, 1, 2, 3, 4, 4xl, 5, 5xl.

| | | |
|-------|--|------------|
| MU0 | 4", Tiny Dogs, Cavaliers, Yorkies and Mini Poodles | \$4.80/ea |
| MU1 | 4.75", Jack Russels, Pugs, Dachshunds, Westies | \$4.80/ea |
| MU2 | 5.5", Beagles, Border Collies, Cocker Spaniels, Standard Poodles | \$4.80/ea |
| MU3 | 7.25", Bull Terriers, Dobermans, German Shepards, Labradors | \$4.80/ea |
| MU4 | 9.5", Large Dogs, Bloodhounds, Danes, St. Bernards | \$4.80/ea |
| MU5 | 8.5", Bull Mastiffs, Large Boxers, Rottweilers | \$4.80/ea |
| MU4XL | 11.5", Great Danes, Large Bloodhounds, Large St. Bernards | \$4.80/ea |
| MUSXL | 10.5", For extra large dogs that are listed in size 5 | \$4.80/ea |
| MU6 | CAT MUZZLE-REGULAR SIZE | \$4.00/ea |
| MZSET | Set of 8 | \$24.99/ea |



Jor-Vet Nylon Muzzle

Expanded line of high-quality water resistant nylon muzzles that have a side easy-release snap buckle. Comes in a variety of sizes.

Features:

- Safety: muzzles fit securely with adjusting straps for a snug fit.
- Comfort: lightweight nylon feels and looks more professional than gauze roll.
- Quality: reinforced stitching to assure long-lasting use.

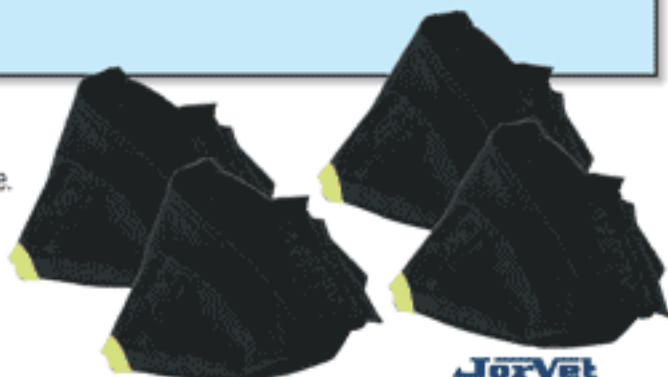

| | | |
|----------|----------------------------------|------------|
| JOR169AA | XX-small | \$5.70/ea |
| JOR169A | X-Small 4.5" Snout Circumference | \$5.70/ea |
| JOR169B | Small 5.25" Snout Circumference | \$5.70/ea |
| JOR169C | Medium 6" Snout Circumference | \$6.00/ea |
| JOR169D | Large 6.5" Snout Circumference | \$6.00/ea |
| JOR169E | X-Large | \$6.00/ea |
| JOR169FT | Set of 3 Feline Muzzles | \$15.00/ea |
| JOR169FS | Small Cat | \$5.55/ea |
| JOR169F | Medium Feline 6 + lbs | \$6.00/ea |
| JOR169FL | Large Cat | \$5.40/ea |



| | | |
|----------|--|-------------|
| JOR169G | Jumbo 10" Snout Circumference | \$6.00/ea |
| JOR169H | Labrador Retriever, Snout 11.0", Weight 100-120 lbs, Color Green | \$6.00/ea |
| JOR169JL | Chow, Large | \$5.70/ea |
| JOR169JM | Chow, Medium | \$5.70/ea |
| JOR169JS | Chow, Small | \$5.70/ea |
| JOR169KL | Long Snout, Large | \$5.70/ea |
| JOR169KM | Long Snout, Medium | \$5.70/ea |
| JOR169KS | Long Snout, Small | \$5.70/ea |
| JOR169M | 4XL | \$5.70/ea |
| JOR169N | 5XL | \$5.70/ea |
| JOR169PL | Pug Nose, Large | \$6.00/ea |
| JOR169PS | Pug Nose, Small | \$6.00/ea |
| JOR169PT | Set of 2 Pug Faced Muzzles | \$12.75/ea |
| JOR169Q | Set of 5 | \$26.40/set |
| JOR169R | Set of 7 | \$42.75/set |
| JOR169S | Set (A,B,C,D,E,F,G) | \$37.50/set |
| JOR169T | Set of 10 | \$56.00/set |

Nylon Chow Muzzle Set

JOR169JT Set of 3 Chow/Rottweiler Muzzles. \$17.25/set

Nylon Long-Snout Muzzle Set

JOR169KS Long Snout, Small \$5.70/ea
 JOR169KT Set of 3 \$17.25/set





Nylon Ferret Muzzle

JOR169K Anyone working at all with ferrets will appreciate this muzzle. \$4.50/ea

Buster Nylon Basket Muzzle

JOR884K Size #11, Boxer, etc. Constructed of strong nylon plastic with a reinforced nose and strong leather strap. Color: tan \$12.00/ea



Jorvet Buster Deluxe Vet Restraint Bag

The best product out there for restraint!! with these additional features:

- Two carrying nylon straps: ease of transport
- Circular opening over back injection site
- Large velcro flaps over back and smaller for neck
- Faux fur-lined collar for patient comfort
- Four metal heavy-duty zippers: two for front legs and two on back underneath for rear legs
- Rear located velcro flap
- Heavier nylon material that is lined inside with water resistant material
- Color coded for size
- Hanging tab for easy access

| | | |
|----------|---------------------------------------|--------------|
| JOR1088 | Small, Red, <2kg (4.4 lbs) | \$36.00/ea |
| JOR1088A | Medium, Royal blue, 2-4kg (4.4-9 lbs) | \$54.00/ea |
| JOR1088B | Large, Green, 4-6kg (9-13 lbs) | \$54.00/ea |
| JOR1088C | X-Large, Light blue, 6+kg (>13 lbs) | \$57.00/ea |
| JOR1088D | Set of all four bags | \$176.00/set |



Jorvet



McLean Folding Net

Four feet long when extended with a triangular net opening. This net is ideal for handling cats and other small animals. It works well in corners and folds up to fit in a belt scabbard. The working parts are made of brass, stainless steel and aluminum. The soft 5/8" netting is gentle but strong.

| | | |
|------------|--------------------------------|-------------|
| ACE-FN-LXK | 15" Long, 20" Across, 21" Deep | \$120.00/ea |
|------------|--------------------------------|-------------|

Freeman Cage Net with Cover

Zipper on bottom of bag for easy access.



| | | |
|-----------|---|-------------|
| ACE-FP-CC | Ideal for animal under 25 lbs. 50" long. Net is 15" across, 30" deep. | \$106.86/ea |
|-----------|---|-------------|

Nylon Feline Restraint Bags

These nylon bags are designed for proper restraint of fractious cats. They offer 2-way zipper running full length over back for either front or rear access. Comes equipped with a quick-close velcro collar and front leg openings. Pull-tab zipper flap provides quick, fur-free closure. Washable/waterproof.



| | | |
|---------|--|--------------|
| JOR170S | Small, 1-5 lbs. Grey. | \$23.10/bg |
| JOR170 | Medium, 5-10 lbs. Navy | \$22.05/bg |
| JOR170L | Large, 10-15 lbs. Royal Blue. | \$22.05/bg |
| JOR170M | X-Large, 15 - 25 lbs. Royal Blue | \$21.00/bg |
| JOR170N | XX-Large, >25 lbs. Royal Blue | \$24.00/bg |
| JOR170T | Set of 3, Small, medium, large. | \$60.00/pr |
| JOR170W | Set of 4, Small, medium, large and X-large. | \$90.00/set |
| JOR170X | Set of 5, Small, Medium, Large, X-Large and XX-Large | \$109.00/set |

Jorvet

Jorvet Welbourn Cat Catcher

The Welbourn cat catcher is designed to aid the veterinarian in safe and easy handling of even the most unruly animals. The Welbourn cat catcher is constructed of tough nylon webbing and can be opened or closed quickly as needed.



| | | |
|---------|---|------------|
| JOR203 | Regular Size | \$62.00/ea |
| JOR203L | X large with Larger Bag and Longer Pole | \$89.10/ea |

Cat Grasper

This lightweight grasper was designed primarily for the effective seizure and control of cats. It is ideal for reaching into the back of a cage to secure a difficult cat. The smoothly curved and finished jaws are plastic-covered and designed to minimize discomfort. If necessary, the animal can be quickly released.



| | | |
|---------|-----|------------|
| JOR141A | 30" | \$98.00/ea |
|---------|-----|------------|

Jorvet Mesh Cat Restraint Bag

White polyester mesh bag with rear nylon drawstring opening. The end has a canvas collar with velcro closure. Useful for general restraint in examination treatments or grooming. The bag will fit most cats.

| | | |
|--------|------|-----------|
| JOR172 | Mesh | \$6.60/bg |
|--------|------|-----------|

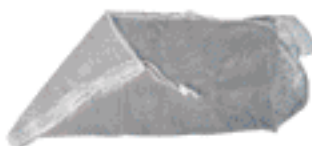

Ketch-All Pole

This is the original "Rabies Stick" for restraint of vicious or hard to control animals. The metal pole has a locking mechanism to hold the cable tight plus a quick release button. Rubber cushion grips for two-handed no slip control. The end of the shaft has a covered portion to protect against chewing.

| | | |
|---------|--|-------------|
| JOR915 | 3 ft., Suitable for cats and small dogs. 1 3/4 lbs. | \$109.00/ea |
| JOR915A | 4 ft., The most popular for general use. 2 lbs. | \$119.00/ea |
| JOR915B | 4-6 ft extendable, Telescopes from 4-6 (E when additional length is needed. 2 1/2 lbs. | \$162.00/ea |

Jorvet



Restraints - Snarem, Syringe Pole & Restrainer Cage

Snarem Restraint

The pole is heavy gauge ribbed aluminum tube with a noose that is made of braided plastic coated aircraft cable. The device locks with a slight twist of the hand and both ends move in and out at the same time eliminating noose kinks.

| | | |
|----------|--------------------------|------------|
| EJS-EM-3 | 3 Foot | \$40.17/ea |
| EJS-EM-4 | 4 Foot | \$43.73/ea |
| EJS-EM-5 | 5 Foot | \$49.18/ea |
| EJS-EM-6 | 6 Foot | \$54.63/ea |
| EJS-EM-N | Snarem Replacement Noose | \$13.86/ea |



Animal Restrainer Cage

The MDC Animal Restraint is suitable for cats or any small animal, and is an effective means for limiting movement in order to administer an injection or effect treatment.

| | | |
|--------|-----------------------------|-------------|
| JOR142 | 11 1/2"W x 17 1/2"L x 11"D. | \$195.00/ea |
|--------|-----------------------------|-------------|

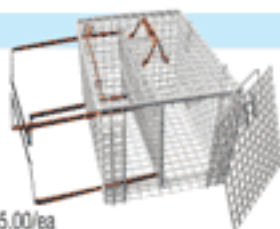

Quick Release Dog Pole

MDC dog poles have been designed to meet the animal control needs of veterinarians. The durable yet lightweight aluminum handle and features a quick-release mechanism.

| | | |
|---------|-----|-------------|
| JOR140B | 39" | \$185.00/ea |
| JOR140A | 28" | \$180.00/ea |
| JOR140C | 70" | \$240.00/ea |



Trap Transfer Restrainer

has the added benefit of a facility for transferring the patient from a trap without the need for physical handling. Opening: 10 1/2" x 8".

| | | |
|---------|------------------------------------|-------------|
| JOR142T | Overall: 111/2"W x 171/2"L x 11"D. | \$176.00/ea |
|---------|------------------------------------|-------------|



Jorvet Safety Stick Syringe Pole

This syringe allows you to obtain a proper needle stick, then push the dosage plunger on the operator end. Uses a standard 3cc syringe. Mechanism cannot be damaged by even the most powerful animal bite Available in 3 different lengths. Easy to inject through cage or from a safe distance.

Syringe recommended: 3cc disposable syringe.

- Constructed of aircraft aluminum alloy and stainless steel.
- Black anodized satin finish.

| | | |
|---------|--------|-------------|
| JOR482A | 3 foot | \$118.00/ea |
| JOR482C | 6 foot | \$147.00/ea |
| JOR482B | 4 foot | \$138.00/ea |



5-Way Plastic Door Gate

5-Way Plastic Door Gate is durable and simple to use. Constructed of high impact plastic, this gate can be used in a variety of ways. Can be used as either pressure or swing gate. Mounting hardware included for use as swing gate. Fits doorways 26"-42" wide. Gate is 26" high.

| | | |
|---------|----------|------------|
| CP78625 | 26" high | \$39.99/ea |
|---------|----------|------------|



Tattoo Paste

RKTATTOO-G Green, 5oz

\$14.29/ea



Tattoo Digits & Numbers

Used for positive permanent livestock identification. Heavy-duty construction. Marker jaws holds four easily interchangeable letters or digits. Digits only go in one way. Positive ear release.

JorVet

| | | |
|---------|----------------------------|------------|
| JOR643 | Standard Size Digits 0-9 | \$9.00/ea |
| JOR643L | Standard Size Letters A-Z. | \$24.00/ea |



Jorvet Tattoo Ink

Tattoo ink is widely used for identification in livestock, especially cattle and swine. JorVet tattoo ink is easily read years after tattooing. Now JorVet has expanded the range of permanent tattoo inks. Inks are available in black and green, and varied packaging

| | | |
|---------|------------------|-----------|
| JOR276G | Green, 2oz Fluid | \$6.90/ea |
|---------|------------------|-----------|



Halti Head Collar



The Halti was developed over 27 years ago and has been used by over a million dog owners worldwide. The innovative design steers the dog to the side to minimize pulling. It is neck and throat friendly as it doesn't put any pressure on that area. It is eye friendly as the nose band lies well away from the eyes. The slack chin straps allow freedom to pant and the minimal movement of the nose band prevents irritation.

| | | |
|----------|--|-------------|
| JOR1011A | Size 0, Fits Toy Poodle, Yorkie, Papillion, and other toy breeds | \$9.00/ea |
| JOR1011B | Size 1, Fits Jack Russell, Daschund, Westie, etc | \$9.60/ea |
| JOR1011C | Size 2, Fits Beagle, Cocker Spaniel, Schnauzer, etc | \$9.60/ea |
| JOR1011D | Size 3, Fits Boxer, Labs, Shepherds, Setters, etc | \$9.60/ea |
| JOR1011E | Size 4, Fits Rottweiler, Mastiff, Newfoundland | \$9.60/ea |
| JOR1011F | Size 5, St Bernard, Great Dane, Bloodhound | \$9.75/ea |
| JOR1011S | Introductory display kit. Includes 2 each of the 3 smaller size and 4 each of the 3 larger sizes, plus display head. | \$133.50/ea |

Pet, Grooming & Restraints

Pets - Harnesses, Leads & Pillers



Jorvet Halti Harness



The Halti Harness was designed by Dr. Roger Mugford, the creator of the Halti head collar. The Halti Harness has a unique patented front attachment system that controls the dog from his chest and shoulders; an effective point of control. The Halti Harness stops pulling, calms over-boisterous dogs and simplifies training and behavioral therapy. The benefit of a properly used Halti Harness is that it gives total control over the dog's shoulders and thus sets the direction he can move.

| | | |
|----------|-------------|------------|
| JOR1012A | Size Small | \$7.50/ea |
| JOR1012B | Size Medium | \$8.25/ea |
| JOR1012C | Size Large | \$10.00/ea |



Animal Lead

Manufactured from braided poly "ski type" rope, these five foot long leads are non-abrasive and have nickel plated rings for strength and reduced friction. Bright two-tone blue and white finish. 12 per package.

| | | |
|----------|---------------|-----------|
| EJPEL-5R | 5 foot, 12/Pk | \$7.80/pk |
|----------|---------------|-----------|



No-Pull Trainer

The No-Pull Trainer is a lightweight device designed to stop all dogs from pulling. It will stop any dog of any size, guaranteed! The trainer is available in three sizes and easy to put on. No collar is required. A trainer that gives you maximum control without choking your dog!

| | | |
|-----------|--------|-----------|
| AP-F59325 | Small | \$6.48/ea |
| AP-F59335 | Medium | \$7.20/ea |
| AP-F59345 | Large | \$7.20/ea |



Safety Cat Lead and Harness

The 6 foot lead is made of polypropylene, a completely washable material that will not fray! The lead is fully adjustable and will not slip or bind.

| | | |
|-----------|----|-----------|
| AP-F00400 | 6' | \$2.80/ea |
|-----------|----|-----------|



Retriever Retractable Leash

The 'Retriever Retractable Leash' has a belt style leash. The rubber comfort grip gives the unit a high quality look and feel, while the one touch leash lock and durable waterproof construction makes this unit a real buy. Add a safety strobe that can be turned on for night walks, and you have a uniquely superior product.

| | | |
|---------|-----------------------------------|------------|
| CP21180 | Large, Red, 23ft, 180lb capacity | \$12.52/ea |
| CP21040 | Small, White, 10ft, 40lb capacity | \$8.37/ea |
| CP21080 | Medium, Blue, 16ft, 80lb capacity | \$10.53/ea |



Pet Piller

Pet Pill Gun used in administering pills to small animals. Unique feature allows a small amount of water to pass with the pill to facilitate swallowing.

| | | |
|-------|--------|------------|
| JOR67 | 12/pk. | \$14.40/dz |
|-------|--------|------------|



Pet Piller

Long plastic barrel with plastic plunger. Designed like a large animal balling gun. Administer tablets and capsules to pets more quickly, safely, and easily.

- Soft latex rubber tip
- Easy to clean
- Gentle to pet's mouth
- Correct size even for small pets



| | | |
|---------|---|--------------|
| JOR384 | 12/Bag | \$16.80/bg |
| JOR384S | Dozen, Carded Individually shrink-wrapped for display. 12/pk. | \$22.20/12pk |



Four Paws Nite-Brite Reflective Leash

Nite Brite Leashes make walking your pet safer than ever before with our newly patented, reflective material. Visible from 200 feet, the round braided leashes capture light from any direction.

| | | |
|-----------|-------------------------------|-----------|
| AP-F55361 | 3/8" Wide, 6 Feet Long, Black | \$9.37/ea |
| AP-F55561 | 5/8" Wide, 6 Feet Long, Black | \$9.90/ea |



Buster Pet Pillers w/Soft Tips

- New and improved model
- Finger rings for better control
- Soft rubber jaws to reduce the chance for injury and are more comfortable for the patient
- Can draw water into pet piller to aid swallowing
- Attractive display boxes hold 10 pet pillers
- Transparent barrel

| | | |
|---------|-------------|---------|
| JOR384X | Display Box | \$15.00 |
|---------|-------------|---------|



Pet, Grooming & Restraints

Pets - Toys & Chewys



Wubba Wubba

Easy to pick up and throw. Dogs love the squeaker and long tails!



Water Wubba

Neoprene floats and dries fast for water and snow play. No squeaker.



Wubba Wubba Jr.

Easy to pick up and throw. Dogs love the squeaker and flapping tails.



Snugga Wubba

Soft fleece for gentle indoor play. No squeaker.



Kong Wubba

Another great toy from Kong! Fun to tug, fun to toss, fun to say! Small Wubba contains two squeakers. Will the fun ever end? Reinforced Nylon covers this durable, interactive toy. Easy on the mouth and dogs have fun flapping the tails. We think you'll get a kick out of it too! The Small Wubba is 8 1/2 inches long. This is not intended to be a chew toy. Always supervise play sessions.

The Original Wubba Wubba

WW-10 4" x 17", Assorted Colors \$7.99/ea

Water Wubba

WW-19 4" x 17", Assorted Colors \$7.99/ea

Snugga Wubba

WW-29 4" x 17", Assorted Colors \$7.99/ea

Wubba Junior

WW-50 3.5" x 13", Water Wubba Junior, No Choice of color \$7.99/ea

WW-52 3.5" x 13", Junior, No Choice of color \$7.99/ea

KONG WUBBA

EJWP3 Puppy Size \$4.70/ea

EJWB3 Small Size \$3.50/ea

EJWB1 Large Size \$4.95/ea



Interactive Cat Tower

Triple platforms for triple the excitement. Poles coated with sisal make for divine scratching posts. (Decoys to save your curtains and sofa.) A catnip container and interactive toy balance out this popular kitty climber.

CP70211 Beige, 25x20" Base, 48" Height \$74.66/ea



Perch Tower

Sturdy post and perch combo smothered with plush carpet. A dangling interactive toy guarantees all kinds of befuddling fun. Hours of entertainment for cats and humanoids alike.

CP71921 \$31.50/ea



Lazy Mouse Laser

The Lazy Mouse Laser projects a mouse image and is safe for all ages. This product is a great exercise item for your pet, includes batteries. FDA Registered and built to last!

CP24300 \$7.25/ea



Catnip Scratching Post

This scratching post contains organically grown catnip to attract cats and kittens. You can hang it from a doorknob or lay it flat. Let your cats scratch this post instead of your furniture, drapes and rugs.

AP-F01668 each \$4.86/ea



Nylabone Puppy Starter Kit

N201PSK 1 Bacon Bone Regular, 1 Durable Chicken Regular, 1 Flexible Puppybone Regular \$4.99/pk



ODOR CONTROL

SEE OUR PHARMACEUTICAL & STERILIZATION SECTIONS



Plush Vegetable Toy with Squeaker

Give you pet more vegetables, plush vegetables that is! These plush veggies are great attention grabbers for your pets with the bright colors and built in squeaker. Made with bright, durable material, your pet will enjoy its company all the time!

CP79394 7" Carrot \$2.30/ea

CP79398 4" Tomato \$2.30/ea

CP79396 6" Eggplant \$2.30/ea



13822 WEST BOULTON BLVD. METTAWA, IL 60045

WWW.SHOPMEDVET.COM

Phone 800-544-7521

143

Fax 800-204-2177



Jorvet Feline Litter Magnet

An all-natural solution to encourage litter box use. Litter Magnet™ will assist you in treating the most troubling behavioral problem a cat can have, inappropriate elimination, i.e. non-use of the litter box. Often this problem is not medical and cannot be treated with medication. Treatment becomes a consultation with the pet owner, representing time spent for which it is often difficult to be compensated. LitterMagnet™ and its supporting brochure will give you a product that can be prescribed with a tested solution that will help your customer get their cat "back to the box".

An all-natural herbal product, LitterMagnet™, uses its rich earthy fragrance to attract the cat to its litter box. Once the cat goes to the box and finds that it is clean and filled with an appropriate substrate, it will use it and positive behavior modification begins. With LitterMagnet™, you can address a behavior problem and be able to prescribe a solution. You have also made a pet owner happy and possibly kept the cat out of a shelter or from being abandoned.

- LitterMagnet™ (Jorvet Product #J1001)
- 20 oz bottle with a shake and pour lid
- Treats 100 pounds or more of clumping/scoopable clay litter
- A client education brochure is provided with each bottle
- 6 bottles per case

JOR1001 \$10.20/ea



Cookie Nut Ring

A 7" ring of large and small cookies, pecans, almonds, colored wood balls and wheels.

PA33110 10" x 7.5" x 2.75" \$6.93/ea



Bird Toy Crown

A ring of colored wood, chunks, squares and balls, along with natural rawhide and colored rope. Diameter is 7".

PA33423 1.5" x 6" x 7" \$3.50/ea



Rainbow Tower of Power

Tight vertical collection of colored wood circles, plastic balls and a dozen rope knots.

PA33537 6" x 16" x 6" \$12.14/ea



Training Clicker with Wrist Strap

Plastic clicker to be used with the clicker training method. Train your pet humanely and get positive results. Use the fun clicker method to improve your pet's behavior.

CP17700 \$1.60/ea



Thermo Perch

Protect your exotic birds from harmful effects of air conditioning or cold drafts. Cold is a major detriment to the health of tropical birds. Providing warmth should be the first step in treating any sick bird. Birds lose much of their body heat through their feet. Thermo Perch is made of sturdy scratch and bite resistant plastic. Irregularly shaped, it prevents foot cramps and pressure sores. The perch easily external-mounts to any wire cage, with the cord protected in steel casing. U.L. approved. Patent-pending.

JOR919 Small, 1/2" - 1" dia. x 10 3/4" L \$40.20/ea
JOR919A Medium, 5/8" - 1 1/4" dia. x 13" L \$58.00/ea
JOR919B Large, 1 1/4" - 2" dia. x 14 1/2" L \$58.00/ea



Bird Nail & Feather Trimmer

The very small nails of birds require delicate trimming to avoid bleeding or injury. Other trimmers are simply too large to do a proper job. Stainless steel notched blades.

JOR391 10cm L. \$3.30/ea **Jorvet**



Jorvet Bird Leg Ring Cutter

Aluminum and plastic leg rings frequently prevent venous return from the distal limb of small birds. Edema and necrosis quickly follows unless the ring is removed. Removal of the ring or band without fracturing is not easy without this special cutting tool.

JOR391Q 4" \$44.00/ea



Pet, Grooming & Restraints

Pet Supplies - Toys



Hanging Cat Scratcher and Toy

These durable scratching boards also serve as a toy for your cat. Not only do you get a replaceable scratching board, you also get noise making crinkle material inside the arms and legs, a tail with a plastic lattice ball and bell, and a moveable toy on the scratching board. All these things add up to hours of fun for your cat! The board measures 32" long from the top of the hanging rope to the tip of the tail. The actual body size is 22.5" long and 8.5" wide.

CPCS995 Grey Mouse \$12.99/ea



Talking Bone Toy

The Talking Bone Toy allows you to record a message for your pet and whenever it touches the toy it hears your voice. Great company for your loved one while your out. A fun way to let your pet know you care.

CP22011 \$12.50/ea



Rope Toy

These durable, long-lasting rope toys are sure to please the most finicky of dogs. Made from cotton rope for hours of enjoyment.

CP76111 11" Multi-Color Double Knot \$1.20/ea
CP76017 17" White Double Knot \$6.60/ea



Cotton Rope Handle w/Tennis Ball

These are the ultimate for interactive play between owners and their pets. A heavy-duty cotton rope with attached tennis toy give a healthy chewing workout.

JOR617 \$6.45/ea



Belly Buddies Dog Toy

Ever have the problem of getting your dog a new toy only to watch him tear at the belly to get at the stuffing and squeaker inside? Well, now you can give your dog what it wants. When they dig and chew at the belly of these toys, they get a tennis ball out to play with. And, if you want to make it even more interesting, put a treat behind the ball. These should truly keep your pet entertained for hours.

CP55803 Plush Red Frog, 8" \$5.50/ea
CP55816 Plush and Rope Rabbit \$5.99/ea



Buster Cube JorVet

Studies show that there is a correlation between behavioral problems and too much rest and boredom. The new JorVet Buster Cube is a simple and ingenious toy for stimulating your dog mentally, helping him to improve his concentration skills, and motivating him to use up excess energy. The Buster Cube is easy to use. All that is needed is a handful of dry food placed in the Cube through the opening. When the dog rolls the Cube, the dry food falls out, and his efforts are instantly rewarded. His discovery encourages him to continue playing with the Buster Cube. The Buster Cube offers any dog a natural and fun way to exercise and utilize his problem-solving capabilities.

JOR600 \$15.00/ea

Buster mini-cube

JOR600MC \$15.00/ea



Rawhide Chew-Round Safety Knot

Rawhide Brand Chews are completely natural without chemicals, preservatives or bleaches like other chews. Rawhide Brand Chews are made from natural grass fed beef hides. Patented Round Safety-Knot bone design slows down the chewing process resulting in long-lasting chewing pleasure. Economical pricing and high value as well as the attributes listed above.

PA20700 6" \$1.93/ea

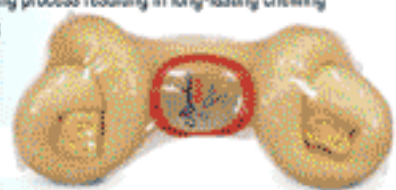

Vinyl Dog Toy

Super strong and extra durable Vinyl Toys in colorful, outrageous designs. Each with internal squeaker for more fun. All materials are non-toxic and the squeaker is the safety-type. The vinyl itself is the strongest made.

CPDH500 Medium Hedgehog \$2.15/ea
CPTCR12 Soccer Ball \$4.50/ea



Jorvet Plush Toys

Durable multi-colored toy is easy to grip for both owner and animal. It comes with attention grabbing squeaker

JOR618E Frisbee \$4.50/ea
JOR616F Football \$3.75/ea
JOR616T T-Tugger \$4.50/ea



SHOPMEDVET.COM

YOUR ONE STOP VET SHOP!

WWW.SHOPMEDVET.COM

Fax 800-204-2177

13822 WEST BOULTON BLVD. METTAWA, IL 60045

Phone 800-544-7521

145



Nutri Dent Brush Bone

Unique dental nubs provide 360 degree "all around" cleaning action to help clean teeth, freshen breath and massage gums with every chew!



| | | |
|----------|----------------|-----------|
| NTD-100M | Small, 12/pack | \$7.65/pk |
| NTD-101M | Medium, 8/pack | \$7.60/pk |
| NTD-102M | Large, 4/pack | \$7.60/pk |

Nutrient Bones

Unique dental nubs provide 360 degree "all around" cleaning action to help clean teeth, freshen breath and massage gums with every chew! Each bone in the tower is individually wrapped!



| | | |
|--------|------------------------|------------|
| ND-354 | Small Tower, 75 bones | \$50.57/ea |
| ND-355 | Medium Tower, 30 bones | \$30.92/ea |
| ND-356 | Large Tower, 25 bones | \$45.76/ea |

Filet Mignon Flavored Nutri-Dent Bones

| | | |
|-----------|------------------|------------|
| NTD600M9 | Small, 9 Bones | \$5.00/pk |
| NTD601M18 | Medium, 18 bones | \$12.59/pk |

NTD601M18



Greenies

| | | |
|----------|-----------------------|------------|
| RXGRP-24 | Petite Size, 24/pack | \$11.50/pk |
| RXGR-14 | Regular Size, 12/pack | \$11.50/pk |
| RXGRL-8 | Large Size, 8/pack | \$11.50/pk |
| RXGRJ-4 | Jumbo Size, 4/pack | \$13.99/pk |



Cat Grass Plus

Satisfies a Cat's natural craving for grass, helps natural digestive system and acts as a natural hairball remedy. Easy to grow, water only once, special water absorbent additive, grass grows straight from the container

| | | |
|---------|-----------|-----------|
| RK74670 | 150gm Tub | \$4.50/ea |
|---------|-----------|-----------|



Blue Kong

Kong entertains, amuses and occupies pets who are bored, mischievous or suffering from separation anxiety. With tensile strength measuring in excess of 3800 psi, Kong Blue is 25% stronger than Kong toys sold in pet shops. Can be stretched up to nine times its original length and is puncture resistant. Made from nontoxic, nonabrasive and non splintering natural rubber. Now radiopaque.

| | | |
|-------|-----------|-----------|
| EJVT3 | Small | \$3.36/ea |
| EJVT2 | Medium | \$4.71/ea |
| EJVT1 | Large | \$5.50/ea |
| EJVTX | X-Large | \$7.58/ea |
| EJVTK | King Kong | \$9.58/ea |



Dental Kong

A thick, natural rubber provides a real "chewing" workout for any dog. It's beehive design also makes this a great fetching toy that will bounce unpredictably in every direction when thrown. And it floats!

| | | |
|-------|------------------|------------|
| EJDK3 | Small with rope | \$7.43/ea |
| EJDK2 | Medium with rope | \$7.75/ea |
| EJDK1 | Large, No Rope | \$7.75/ea |
| EJDXL | X-Large, No rope | \$10.13/ea |



Kong Stuff'n

Training treats for positive behavior, low in fat and calories. Natural Liver Treats contains: Beef Liver, Flour, Bran and Water. Natural Lean Treats contain ONLY 3 ingredients, are gluten free, low fat and one calorie a piece. Kong Blue Stuff'n Liver Paste is vitamin enriched, promotes healthy skin and coat. Kong Blue Stuff'n Peanut Butter Paste is specially formulated for dogs.

| | | |
|-------|---|-----------|
| EJXS1 | Kong Blue Stuff'n Liver Paste, 8oz, All Size Dogs | \$4.41/ea |
| EJXS2 | Kong Blue Stuff'n Peanut Butter, 8oz, All Size Dogs | \$4.95/ea |
| EJXS2 | 8 oz. can | \$4.65/ea |



Dental Stick

Kong Dental have "Chew Clean" grooves and patented "Denta-Ridges" to reduce plaque and food debris while providing a gentle abrasive cleaning and conditioning of the teeth and gums.

| | | |
|-------|--|-----------|
| EJKD2 | Medium, 15-35 lbs Recommended Dog Size | \$5.26/ea |
| EJKD1 | Large, 30-65 lbs Recommended Dog Size | \$5.96/ea |
| EJKD3 | Small, 1-20lbs Recommended Dog Size | \$3.48/ea |

Ziggies

Healthy dog treats made for Kong Toys! They freshen breath, clean teeth and are easily digestible!

| | | |
|---------|--------------------------------------|------------|
| EJXZ32 | Small Puppy, 15-35 LBS. | \$10.58/ea |
| EJXZ22 | Medium Puppy, 15-35 LBS. | \$10.58/ea |
| EJXZ12 | Large Puppy, 30-75 LBS. | \$10.58/ea |
| EJXZ121 | Medium Puppy, 6-20 lbs, Z-Cube 25 pc | \$39.00/pk |
| EJXZ131 | Small Puppy, 6-20 lbs, Z-Cube 25 pc | \$41.20/pk |
| EJXZ111 | Large Puppy, 30-75 lbs, Z-Cube 25 pc | \$39.16/pk |





Disposable Litter Pan **JorVet**

Economical, sturdy and disposable, these treated pulp litter pans cost just a few cents each. Stackable for easy storage. Requires only a small amount of litter.

JOR976B 9" x 12" x 1", 250 per case \$111.00/cs

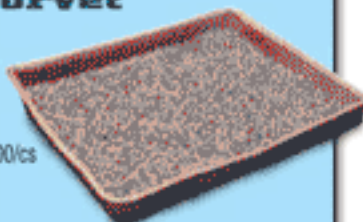

Plastic Disposable/Reusable Litter Pan

Clear plastic for easy cleaning. Higher lip holds in litter better. Recyclable.

JOR976 9" x 12" x 2 1/2", 100/case. \$164.00

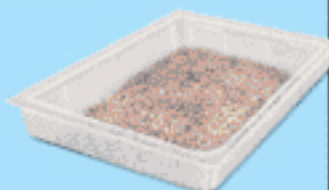

JorVet

Aluminum Disposable/Reusable Litter Pan

This sturdy all-aluminum pan can be reused or recycled. Cleans easily.

JOR976A 9" x 12" x 1 1/2", 100/case \$102.00



Jorvet Lab Litter

Lab Litter™ is a clear, non-absorbent, small plastic granule that feels like cat litter to the feline patient. It is used to help collect urine samples. Bulk container 5 lbs. 4 gallons/case.

JOR164 5 lb container \$42.00/gl



Wee-Wee Housebreaking Aid

A housebreaking aid specially formulated to help spot train a puppy by encouraging him to eliminate in a place selected by you. Works great with Wee-Wee Pads.

AP-F15000 1oz dropper \$5.12/ea
AP-F15010 8oz pump spray \$5.50/ea



Doggie Doo Bags

Doggie Doo Bags are biodegradable and come in a convenient, one at a time dispenser box. They're extremely easy to use and pleasantly scented with a baby powder fragrance to mask odors.

AP-F01815 25 bags/box \$2.55/bx



Doggie Doo Bags Refill Roll

Doggie Doo Refill Bags are quick and easy and avoid messy clean ups.

- Made to use with the Four Paws Doggie Doo Dispenser
- Leakproof
- Strong and durable
- Biodegradable bags
- Bag size: 7" L x 12" H

AP-F01814 30 bags \$2.25/ea

Plain Sanitary Pooper Scooper

Use this scooper for the removal of animal waste pretty much anywhere. The two wrap around scoops are made of aluminum to resist rust. The treated wooden handles also have a hangup loop. Cleaning up after your pet has never been easier!

AP-F18200 32" Height \$10.44/ea



Rake Sanitary Pooper Scooper

Designed for quick pick up of animal waste in tall grassy areas. One side of the 7" scoop is solid while the other is a rake. Just as durable and easy to use as the plain scooper.

AP-F18220 32" Height \$10.44/ea



Deluxe Travel Carrier

Subtle elegance that allows your pet to travel in style. These deluxe soft carriers come in a classic tapestry design. Front opening for easy exit. Carriers come in two sizes so you can bring your small pet everywhere you go. Both carriers will fit comfortably under airplane seats.

CPLV1 15" Tapestry design \$39.99/ea
CPLV2 18" Tapestry design \$51.99/ea



This sturdy corrugated carton is great for transporting patients to and from the clinic. This is a nice dispensing item for veterinarians and makes clinic visits more convenient for the client. *Shipped flat for easy storage.* **JorVet**

JOR133 9"W x 11 1/2"H x 18"L \$106.90
when assembled. 20/carton.



ITS CLEAN UP TIME!

**STOCK UP
ON YOUR
SHAMPOOS
& CONDITIONERS**

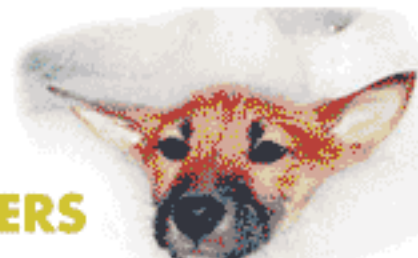

Pet, Grooming & Restraints

Pets - Bowls & Pet Carriers



Regular Stainless Steel Bowls (A)

Stainless Steel is corrosion resistant, and almost chew-proof. They are heavy-duty for everyday use. Cleans and disinfects easily. They will keep their bright shine and new look, and they are dishwasher safe. Standard shape, no sharp edges. 9-gauge thickness, 6-gauge on larger bowls.

| | | |
|---------|---------------------|------------|
| JOR802A | 8oz (1/2 pint) | \$2.10/ea |
| JOR802B | 16oz (1 pint) | \$2.50/ea |
| JOR802C | 32oz (1 quart) | \$3.60/ea |
| JOR802D | 64oz (2 quart) | \$4.10/ea |
| JOR802E | 72oz (2.5 quart) | \$5.10/ea |
| JOR802F | 96oz (3 quart) | \$6.15/ea |
| JOR802G | 160oz (5 quart) | \$7.05/ea |
| JOR802H | 240oz (7 1/2 quart) | \$13.50/ea |
| JOR802J | 320oz (10 quart) | \$19.00/ea |

Heavy Duty Stainless Steel Bowls (B)

Stainless Steel is corrosion resistant, and almost chew-proof. They are heavy-duty for everyday use. Cleans and disinfects easily. They will keep their bright shine and new look, and they are dishwasher safe. Standard shape, no sharp edges. Gauge is 50-100% thicker than the regular bowls.

| | | |
|---------|-----------------|------------|
| JOR803A | 16oz (1 pint) | \$4.90/ea |
| JOR803B | 32oz (1 quart) | \$6.20/ea |
| JOR803C | 64oz (2 quart) | \$8.30/ea |
| JOR803D | 96oz (3 quart) | \$10.90/ea |
| JOR803E | 128oz (4 quart) | \$16.05/ea |

Non-Tip Stainless Steel Bowls (C)

This heavy-duty bowl features a wide diameter and protective rubber cushion, making it more difficult for animals to tip or knock over the bowl. Less chance for messy water and food spills.

| | | |
|---------|----------------|-----------|
| JOR804A | 8oz (1/2 pint) | \$3.60/ea |
| JOR804B | 16oz (1 pint) | \$4.80/ea |
| JOR804C | 32oz (1 quart) | \$7.50/ea |
| JOR804D | 64oz (2 quart) | \$8.40/ea |



Pet Carrier

17"L x 12 3/4"H x 8"W

200 lbs test white cardboard

- 17"L x 12 3/4"H x 8"W
- Special water based coating provides moisture resistance.
- Safe, no staples, strong glued joints and extra ventilation.
- Recyclable, approximately 70% post-consumer recycled product.
- Printed warning "Do not leave animal(s) unattended in carrier."
- Easy assembly instructions on carriers. Easy one-piece construction.
- Sold by the dozen.

PET-C 12/Case \$34.50/cs

Pocket Pet Carrier for Small Animals

- 200 lbs test white cardboard
 - 10"L x 6 3/4"H x 5 1/2"W
 - Special water based coating provides moisture resistance.
 - Safe, no staples, strong glued joints and extra ventilation.
 - Recyclable, approximately 70% post-consumer recycled product.
 - Easy assembly instructions on carriers. Easy one-piece construction.
- Sold by the dozen.

PET-PC 12/Case \$13.75/cs

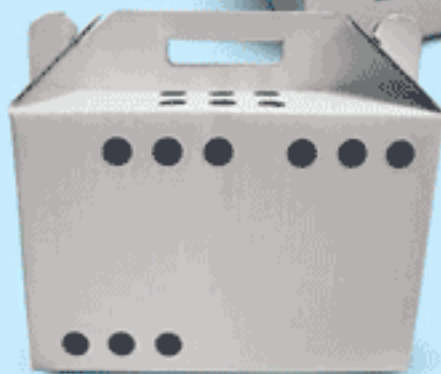

13822 WEST BOULTON BLVD. METTAWA, IL 60045

WWW.SHOPMEDVET.COM

Phone 800-544-7521

1/48

Fax 800-204-2177



Economy Weight Disposable Underpads

Disposable Underpads economy weight, light absorbency, feature diamond-embossed fluff-fill to help control fluid leaks. Added embossed polypropylene backing controls slipping to reduce the risk of leaks on patients and bedding.

| | | | | |
|------------|------------------|------------|---------------|---------------|
| UPAD1724CS | 17" x 24" 300/cs | \$39.00/cs | 2+=\$35.00/cs | 3+=\$32.00/cs |
| UPAD2324CS | 23" x 24" 200/cs | \$39.00/cs | 2+=\$35.00/cs | 3+=\$32.00/cs |
| UPAD2336CS | 23" x 36" 150/cs | \$39.00/cs | 2+=\$35.00/cs | 3+=\$32.00/cs |

Surgery Pads - Cage Liners

Super Absorbent. Makes clean-up easy. Contains unique polymer that locks in odors & fluid. Airstream breathable 23x36", 100/ case. Disposable

SP2336CS 23 x 36 100/cs \$19.99/cs



Polymer Underpads

Eliminate waste with Medline Protection Plus disposable underpads with polymer. These odor-reducing pads lock-in fluids, virtually eliminating the need to stack pads to prevent leaks. Polymer underpads available in deluxe or standard weight. Polymer underpad with wings tucks into the sides of the mattress. Also available are airstream breathable underpads or underpads with wings. Deluxe 36" x 36".

| | | |
|-------------|--------------------|------------|
| MSC282070LB | 36" x 36" 50/case | \$43.17/cs |
| MSC282050LB | 23" x 36" 100/case | \$44.96/cs |
| MSC282060LB | 23" x 36" 75/case | \$39.57/cs |



Ultrisorb Underpads

Ultrisorbs wicks moisture away from the patient's skin and is super absorbent to provide optimal skin care. Moisture is pulled away from the skin to provide better skin care and patient comfort. This premium product is cost-effective because just one Ultrisorbs absorbs what used to require three or more underpads. 23" x 36" overall, 21" x 32" absorbent core.

MSC282100 23" x 36" 70/case \$102.13/cs

Disposable Underpads 23 X 36 Super Absorbent 10/pk

The WeekEnder Premium Disposable Puppy Pads.

- Advanced Supercore thermo-bonded core.
- Wicks moisture away from the surface and locks fluid in within minutes.
- Super absorbent 1 pad absorbs what used to require 3 or more.
- Super strong to reduce tearing and resulting damage to floors.
- Superior odor control.
- Folded over edge for better containment.
- Soft non-woven top sheet across the pad.
- Ultra absorbent polymer is spread throughout the entire core for maximum absorbency.
- Top sheet is fused to the core so it does not bunch up while in use.
- Waterproof polyethylene backing protects underlying surfaces.

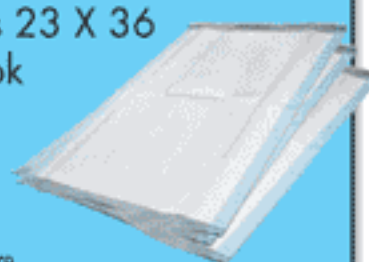

SUPERPAD 23" X 36" super absorbent 10/pk \$14.00/pk

Reusable Underpad

Exactly the same idea as the Puppy Pads, these reusable no-leak protector pads are great for protecting furniture, car seats and bedding! They protect from the staining that occurs from our furry friends accidents. These reusable no-leak protector pads have a top layer which wicks away moisture to a super-absorbent middle layer which also pulls all of the moisture down to the no-leak vinyl. THE PAD IS ALWAYS DRY!!! EVEN AFTER AN ACCIDENT! Machine wash and dry as needed as these pads are reusable!!! Excellent for pets in heat, cages or kennels. 30" x 36" pads

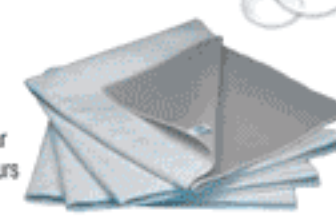

UPAD-R 30" X 36" 1/Each \$7.99/ea

Standard Weight Disposable Underpads

Protection Plus® Disposable Underpads standard weight, moderate absorbency, feature diamond-embossed fluff-fill to help control fluid leaks. Added embossed polypropylene backing controls slipping to reduce the risk of leaks on patients and bedding.

Standard Weight

| | | | |
|--------|------------------------------------|------------|--|
| 281245 | 30" x 30" 150/case Standard Weight | \$51.00/cs | |
| 281242 | 23" x 36" 150/case Standard Weight | \$49.00/cs | |
| 281232 | 23x36 fluff filled Standard Weight | \$49.00/cs | Deluxe Weight |
| 281230 | 17" x 24" 300/case Standard Weight | \$49.00/cs | 281260 17" x 24" 300/case Deluxe Weight \$54.00/cs |
| 281241 | 23" x 24" 200/case Standard Weight | \$49.00/cs | 281264 23" x 36" 150/case Deluxe Weight \$53.00/cs |
| | | | 281227 30" x 30" 150/case Deluxe Weight \$41.00/cs |

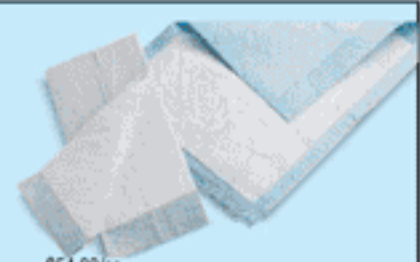

Pet, Grooming & Restraints

Grooming Supplies - Combs



2 Sided Pet Combs

2-sided combs with plastic handle with stainless steel comb.

CPB1026 Pearl Color Handle \$6.50/ea



Greyhound-style Pet Combs

Greyhound-style stainless steel combs.

CPB1041 Greyhound Medium/Coarse \$5.75/ea

CPB1042 Greyhound Fine/Medium \$9.50/ea

CPHD75 Greyhound Med/Coarse \$8.00/ea



Round Back Pet Combs

Round back combs with plastic handle with stainless steel comb.

CPB1004 Fine Stainless Steel Teeth \$5.00/ea

CPB1005 Medium Stainless Steel Teeth \$5.00/ea

CPB1006 Coarse Stainless Steel Teeth \$5.00/ea

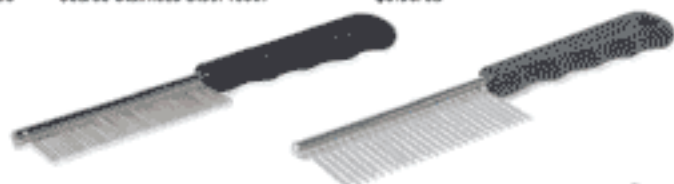

Comb and Dematter Combination

This unique tool has a medium tooth 37-pin comb with a dematter incorporated into the handle. The dematter is hidden or stored in the handle until needed. Easy grip blue handle. Packaged in attractive blister pack display card.

JOR608 \$4.35/ea **JorVet**



Deluxe Flea Comb

Extra-Fine Comb has 36 stainless steel teeth per inch. Comfortable nylon handle, convenient small hanging ring in handle. 12/pk.

JOR321A Extra Fine Teeth, 12 pk. \$45.00/pk

JorVet



Cat Flea Comb

High impact plastic handle, surgical stainless steel teeth, 36 teeth per inch.

EJFK3 32 Teeth per inch, Surgical Steel, molded arch \$3.50/ea

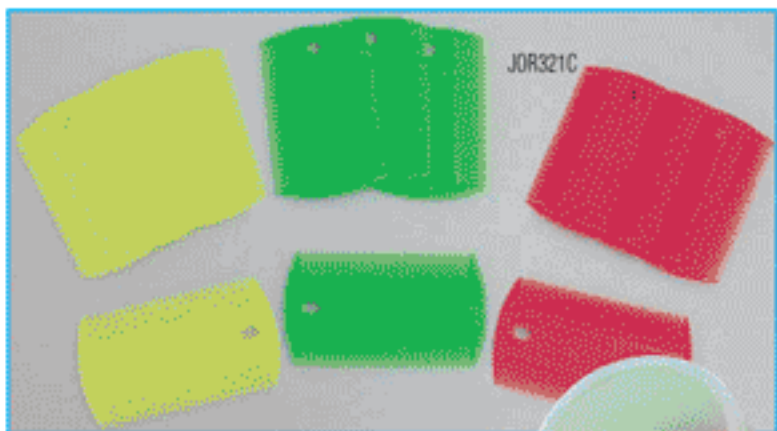

Colored Flea Combs

Assorted Colored Flea Combs. 72 combs in 4 neon colors in a convenient display jar.

JorVet

JOR321C Disposable, 12pk. \$7.20/12z
 JOR321D Colored, 72 in jar \$41.10/ea
 JOR321E Combs only \$36.00/ea



Flea Comb Refill

Flea control combs, high quality. Rakes and combs are professional grade.

EJFK2WR Flea Comb Refill, Nylon, 72 Combs, White \$46.80/cs
 EJFK2MR Flea Comb Refill, Nylon, 72 Combs, Mixed Colors \$46.80/cs



Flea Combs Dispenser

EJFK2D EMPTY COUNTER TOP DISPLAY \$4.43/ea
 EJFK2MD 100 Combs, Mixed Colors \$65.00/cs



Pet Fleakom

Designed and manufactured to withstand hard professional use, these fleakoms have individually placed teeth set firmly into a heavy metal cap which fits over a durable hardwood handle. The "English Type" tapered and rounded teeth are designed to glide through an animal's hair and are pointed enough to penetrate a badly matted coat. These professional grooming tools have the teeth properly spaced to permit grooming with ease.

EJFK-1 Wood-Handle all purpose \$4.65/ea
 EJFK-2 Nylon, 3 1/2" \$0.71/ea



English Flea Comb

English Pattern Flea Comb. 22 stainless steel teeth per inch. Blue nylon handle. 12/pk.

JorVet

JOR321B English Pattern, 12 pk. \$57.00/12z





Pet Dematter

Quality grooming products from Groomaster. Featuring stainless steel dematters with saw-edge blades. Comes with your choice of a heavy-duty hardwood handle or nylon non-slip handles. Most blades can be sharpened or replaced.



| | | |
|----------|---------------------------|-----------|
| CP93001 | 12 Blade | \$7.00/ea |
| CP94002 | Extra Blades for 12 blade | \$2.50/ea |
| CP40290 | Wood Handle, 9 Blade | \$5.75/ea |
| CPK1 | 9 Blade Mini | \$4.00/ea |
| CPK1R | 9 Blade Replacement | \$2.75/ea |
| CPK93001 | 9 Blade Plastic Handle | \$4.50/ea |
| CPK94001 | 10 Blade Rake | \$5.75/ea |

Ultimate Touch Professional Mat Removing Comb

Remove mats with ease using the Professional Mat Removing Comb. The Ultimate Touch grooming line offers high impact molded hardware with rubber accents at sensitive pressure zones.

AP-F11103 \$15.99/ea

Dematting Comb **Jorvet**

Sharp, serrated blades cut through tough mats quickly. Nylon handle. The best way to work through the most challenging cases.

JOR379 \$7.35/ea



Ultimate Touch Shed 'N Blade

The Shed 'N Blade will protect your home and furniture from pet's excess shedding. It is designed to remove all dead and unwanted hair from your pet leaving him with a lustrous and healthy looking coat. Used by professional groomers and handlers.

| | | |
|-----------|-------|-----------|
| AP-F11050 | Small | \$8.99/ea |
| AP-F11051 | Large | \$9.99/ea |



Jorvet Shedder Blade w/Leather Strap

Shedding blade with fine teeth on one side and coarse teeth on the reverse side. Leather strap. The shedding blade is very useful in removing dead and matted fur from thick and heavy undercoats. Packaged in poly bag with attractive header.

JOR607 \$5.10/ea **Jorvet**



Pet Shedder

These stainless steel shedders are wonderful for not only your companion animals, but the larger model works great on larger animals as well...such as horses.

| | | |
|------|---------------------------|-----------|
| CP11 | Small | \$4.00/ea |
| CP12 | Single Circle Medium | \$7.75/ea |
| CP13 | Single Circle Large | \$8.00/ea |
| CP8 | Double Circle Wood Handle | \$5.04/ea |



Tender Touch Slicker Wire Brush

These brushes are manufactured with strong wooden handles, stainless steel pins, and reinforced rubber pads allowing all animals to be brushed with a tender touch.

| | | |
|-----------|-------------|-----------|
| AP-F00340 | for cats | \$5.25/ea |
| AP-F00345 | for puppies | \$5.25/ea |
| AP-F00347 | for rabbits | \$4.78/ea |

Jorvet Slickerbrush® **Jorvet**

The slicker brush does a great job when removing a large amount of hair that a regular comb simply will not pick up and hold. Comes complete with small cleaning comb that removes hair from slicker. Stainless steel back and pins. Plastic handle.

JOR376 5 1/4" \$5.10/ea



Pet Slicker

Quality grooming products from Groomaster. These slickers feature stainless steel pins, which goes through hair much easier. Comes with your choice of wood or plastic handles.

| | | |
|-------|--------------------------------------|-----------|
| CP130 | Mini, Anti-Static, Wood Handle | \$6.25/ea |
| CP131 | Small, Anti-Static, Plastic handle | \$7.00/ea |
| CP132 | Medium, Anti-Static, Wood Handle | \$8.75/ea |
| CP133 | Sensitive Area Triangle, Wood Handle | \$5.50/ea |
| CPH20 | Mini, Anti-Static, Plastic handle | \$4.75/ea |
| CPH50 | Mini, Curved, Plastic handle | \$4.25/ea |



Pet, Grooming & Restraints

Grooming - Gloves, Brushes & Furminator



Cat Grooming Gloves

Most cats enjoy being petted, however, grooming with a stiff comb is often stressful. These white grooming gloves have raised blue dots on both sides that catch loose hair while simply stroking the hair coat. The gloves are 60 percent polyester and 40 percent cotton. Washable. One size fits all. Packaged one pair per poly bag with an attractive header.



JOR603 \$3.75/ea **JorVet**

Hand Brush

Large oval brush with hand strap. Stiffer bristles stimulate coat and skin. Can be used as an invigorating shampoo brush.



CP1065L With hand strap, Stiff Bristles \$3.30/ea

Combo Grooming Brush **JorVet**

This comb and brush has one side with metal pins for removing excess hair and tangles. There are over 120 wire teeth held by a flexible rubber base. The other side is nylon bristle comb that smooths out the hair coat. Attractive dark-varnished wood handle.

JOR604 \$4.50/ea



Pet Brushes

Quality grooming products from Groomaster. These brushes are manufactured from hardwood, not compositions or softwood. All pins are smooth, round, bubble-tip and are rust resistant. Bristles are generously and evenly cut nylon, polypropylene or pure boar bristle. Boar Bristles are soft and will not damage even the most delicate coats.



| | | |
|---------|---------------------------------|-----------|
| CP5207 | Small Oval Bristles | \$1.75/ea |
| CP5207B | Small Brush, Boar Bristles | \$2.43/ea |
| CP5208 | Medium Brush, Bristles | \$2.80/ea |
| CP5208B | Medium Brush, Boar Bristles | \$2.38/ea |
| CP5209 | Large Brush, Bristles | \$2.38/ea |
| CP5209B | Large Oval Brush, Boar Bristles | \$2.58/ea |
| CP5211 | Small Brush, Bubble-Tip Pins | \$2.22/ea |
| CP5495 | Medium Brush, Bubble-Tip Pins | \$2.50/ea |
| CP5497 | Large Brush, Bubble-Tip Pins | \$2.75/ea |

ANIMAL HANDLING GLOVES

SEE OUR GLOVES SECTION FOR A FULL SELECTION



Furminator Deshedding Shampoo

- Promotes a healthier skin and coat to reduce excess shedding
- Enriched with Omega 3 and 6 Fatty Acids plus other vitamins and proteins to help promote healthier skin, a shiny topcoat, and reduce excessive shedding
- Non-irritating, non-drying hypoallergenic formulation
- Works great on all shedding, long and short-haired dogs and cats
- Fresh, clean scent
- Used and recommended by Veterinarians and Professional Groomers worldwide

FUR013 Deshedding Shampoo, 16oz \$7.77/161

Furminator

Revolutionary grooming tool! Quickly and easily removes the undercoat and loose hair without damaging the topcoat. Reduces shedding up to 90%! Guaranteed to reduce shedding better than any brush, comb or rake. Works great on all shedding dogs and cats—long and short-haired. Brings out the pet's natural oils, promoting healthy skin and a shiny coat. Reduces the amount of airborne elements that cause allergic reactions in many people.

| | | |
|-----------|---------------------------------------|------------|
| FUR0132 | Purple, Cat, 1.75" Edge | \$29.99/ea |
| FUR01023 | Double edge, 2.65" | \$49.99/ea |
| FUR003 | Yellow, Medium, 2.65" Edge | \$44.99/ea |
| FUR01012 | Furejector 2.65" Edge, Ejector button | \$49.99/ea |
| FUR004 | Yellow, Large, 4" Edge | \$54.99/ea |
| FUR010137 | Green, Equine, 5" Edge | \$54.99/ea |





Pet Rake

Quality grooming products from Groomaster. Designed to remove undercoat and leave the top hair undisturbed. Designed with longer teeth for penetration. All rakes have Tefloncoated steel teeth, except for Item #CPB2009.

| | | |
|----------|----------------------------|-----------|
| CPB2009 | Utility, 2 Row | \$3.75/ea |
| CPJC91 | Undercoat, Regular | \$3.75/ea |
| CPJC91M | Undercoat, Mini | \$3.25/ea |
| CPJC92 | Undercoat, Long Tooth | \$4.00/ea |
| CPJC92M | Undercoat, Mini Long Tooth | \$3.75/ea |
| CPK90001 | Undercoat, Short Tooth | \$3.25/ea |
| CPK90002 | Undercoat, Long Tooth | \$4.25/ea |
| CPB1021 | Medium, Wood Handle | \$5.50/ea |
| CPB1022 | Coarse, Wood Handle | \$5.00/ea |
| CPB1023 | Molting, Wood Handle | \$6.00/ea |



Wood Pet Rake

Designed and manufactured to withstand hard professional use. The "English Type" tapered and rounded teeth are designed to glide through an animal's hair and are pointed enough to penetrate a badly matted coat. These professional grooming tools have the teeth properly spaced to permit grooming with ease.

| | | |
|------|----------------------|-----------|
| EJR1 | 12 Teeth, one-bank | \$4.73/ea |
| EJR2 | 23 Teeth, two-bank | \$6.25/ea |
| EJR3 | 35 Teeth, three-bank | \$6.63/ea |



E-Z Nail Clipper and Filer



Trim the nail with the clipper and smooth the rough edges with the rotary filer. Comes with an extra grinding stone and charger. It's the safe and easy way to trim nails!

5960 \$21.95/ea



Undercoat Rake

Undercoat Rake with two rows of teeth. The extra row of teeth allows this rake to really get at removing clumps of dead and matted hair. Chrome-plated teeth avoid buildup of static in hair. Any dog with a heavy undercoat needs this rake. "T"-shaped non-slip blue handle. Packaged in attractive blister package. **JorVet**

| | | |
|--------|-----------------|-----------|
| JOR612 | 2 rows of teeth | \$4.80/ea |
|--------|-----------------|-----------|

Designed to remove hair from the dense undercoat. One row of teeth in a T-shaped design. Attractive. Tefloncoated teeth with nylon handle.

| | | |
|--------|-----------|---------------|
| JOR378 | \$5.25/ea | JorVet |
|--------|-----------|---------------|



Nail Clippers



| | | |
|--------|------------------------------|-----------|
| CPN01 | 6", Pliers-Type | \$4.50/ea |
| CPN02 | 4.5", Sm Animal | \$2.50/ea |
| CPN03 | Guillotine-Style | \$3.00/ea |
| CPN04 | Cat/Kitten | \$2.50/ea |
| CPN06 | 5", Pliers-Type | \$3.50/ea |
| CPN011 | Heavy Duty Pliers-Type | \$3.25/ea |
| CPN03R | 3/Pk Blades Guillotine-Style | \$2.50/pk |

Nail File (2-sided)



This nail file helps eliminates concerns of cutting nails too short or into nail quick. The nail is first cut with a trimmer then filed down to desired length.

- Rounded concave surface. The inside coarse blade shortens nail length, while the outside fine blade smoothens nail
- Blue non-slip handle
- Packaged in attractive blister pack for display

| | | |
|--------|-----|-----------|
| JOR602 | 6"L | \$2.10/ea |
|--------|-----|-----------|



Nail File

Also available, a double-sided nail file for filing down nails after clipping.

| | | |
|--------|-------------------|-----------|
| CPN013 | Nail Double Sided | \$2.25/ea |
|--------|-------------------|-----------|



SAVE ON YOUR GROOMING SUPPLIES!

Pet, Grooming & Restraints

Grooming Supplies - Clippers



Km2 Clipper

Special features: designed for durability, ergonomically Shaped for Comfortable Use Includes the #10 (1/16" 1.8mm) Competition Series Blade Self Detachable Blade Premium Quality Precision Ground High Carbon Steel Blade. Kit Includes - Clipper w/16 foot professional ground power cord, competition series size #10 (1/16" 1.8mm) detachable blade set, cleaning brush, lubricating oil.

Features:

- Cool Running
- Quiet
- Fast
- Lightweight

9757-300 Km2 2 Speed \$139.95/ea



Arco Clipper

- Professional Cordless Rotary Motor Gear Driven
- Powerful 5500 Strokes per Minute
- Lightweight
- Made in Germany
- Lightweight
- Quiet
- Cool Running, No Spray Coolant Needed
- Hard Chrome Blade Finish Resists Rust & Corrosion

This Kit Includes - Professional cordless clipper/trimmer with indicator light - Precision ground high carbon steel detachable blades, fully adjustable to five cutting positions from #10-#40 - Two drop-in Ni-Cad rechargeable battery packs - Charging base with indicator light - Four snap on guide combs - Cleaning brush - Lubricating oil - Blade guard - Instructions

8786-550 Arco SE \$145.95/ea



Bravura Clipper

80 minutes of battery operation. Includes: cord/cordless clipper, charging storage base, detachable blade set w/5 adjustable sizes from #9 to #40, four snap-on guide combs, cleaning brush, clipper oil, blade guard & instructions.

41870-0430A Bravura \$176.55/ea



Mini Arco Clipper

Features a superior quick detachable blade set. Includes:

- Cord/cordless trimmer
- Charger
- Detachable #30 blade set
- Cleaning brush
- Oil
- Two snap-on guide combs
- Instruction on use

8787-1550 Mini Arco \$115.95/ea



Super Pocket Pro Clipper WAHL®

Pocket Pro Compact Trimmer Quiet, Lightweight Palm size trimmer. Compact and contoured for easy handling.

Includes:

- Oil
- 2 trimming attachment guides
- Blade guard
- 1 AA alkaline battery and instructions.

9961-2001 \$21.95/ea



Stylique Clipper

Slim pencil shape and narrow blade design for accuracy and precision. Available in blue. Great for trimming face, ears & paws.

Includes:

- Trimmer with built in cleaning brush
- 1 AA alkaline battery
- Blade guard
- Oil and instructions

9951-601 Stylique \$18.15/ea

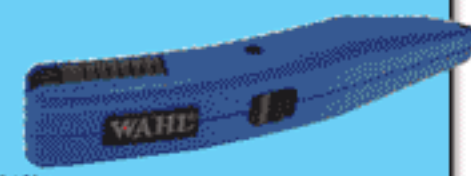

Arco SE Pink

Professional Cordless Rotary Motor Gear Driven Powerful 5500 Strokes per Minute

- Lightweight
- Made in Germany
- Lightweight
- Quiet

Cool Running, No Spray Coolant Needed Hard Chrome Blade Finish Resists Rust & Corrosion This Kit Includes - Professional cordless clipper/trimmer with indicator light - Precision ground high carbon steel detachable blades, fully adjustable to five cutting positions from #10-#40 - Two drop-in Ni-Cad rechargeable battery packs - Charging base with indicator light - Four snap on guide combs - Cleaning brush - Lubricating oil - Blade guard - Instructions

8786-600 \$145.95/ea



Clipper, Touch Up Trimer Kit

9990-602 \$23.65/ea

13822 WEST BOULTON BLVD. METTAWA, IL 60045

Phone 800-544-7521

154

WWW.SHOPMEDVET.COM

Fax 800-204-2177



WAHL®

Clipper Blades

| | | |
|-----------|---|------------|
| #4F-2375 | #4 Full, Extra Coarse, Cut Length of 8mm | \$28.95/ea |
| #3F-2376 | #3 Full, Extra Coarse, Cut Length of 10mm | \$30.95/ea |
| #10-2358 | #10 Medium, cut length of 1.8mm | \$21.95/ea |
| #15-2357 | #15 Medium-Fine, cut length of 1.5mm | \$21.95/ea |
| #30-2355 | #30 Fine, cut length of .8mm | \$21.95/ea |
| #40-2352 | #40 Surgical, Cut Length of .6mm | \$21.95/ea |
| #50-2350 | #50 Ultra Surgical, Cut Length of .4mm | \$21.95/ea |
| #5-2371 | #5 Skip, Cut Length of 6mm | \$27.95/ea |
| #5F-2372 | #5 Full, Coarse, Cut Length of 6mm | \$27.95/ea |
| #7-2367 | #7 Skip, Cut Length of 3.8mm | \$26.95/ea |
| #7F-2368 | #7 Full, Medium Coarse, cut length of 3.8mm | \$26.95/ea |
| #8.5-2362 | #8.5 Medium, Cut Length of 3mm | \$22.95/ea |
| #9-2360 | #9 Medium, Cut Length of 2mm | \$22.95/ea |

Mini Blade

2179-100 Each \$22.95/ea

Bravura Blade

2179-301 Each \$29.75/ea

Andis Clipper Blade

AN15 #15 Medium/Close

\$19.50/ea

Pocket Blade

Pocket Pro Replacement
1001 #40 fine blade, Pocket Pro Only

\$13.95/ea

Clipper Blades 5 In 1 Champion

- Features
- High tech Physical Vapour Deposition finish to prevent corrosion
 - Fits Wahl ARCO SE, Bravura & Chromado clippers
 - Cutting positions #9, #10, #15, #30, #40

41854-7603 \$44.75/ea

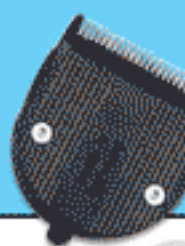
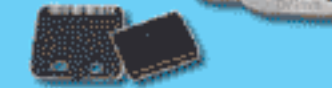

Wahl Ultimate Blades

Wahl Animal Division introduces the latest addition to its professional grooming products, the 'Ultimate' Line of Competition Series Blades. Now professionals can cut their clipping time in half with smoother feeding and faster cutting ability with the New 'Ultimate' Competition Series Blades. The Competition Series - 'Ultimate' Blades have every characteristic a professional looks for in a USA quality manufactured blade.

The new 'Ultimate' Line of blades feature a variety of improvements including:

- Upgraded tooth geometry for higher performance
- High performance blade cuts 2.5x faster (than Wahl Competition Series Blade)
- Smooth feeding leaves no clipper tracks
- Midnight color for easy reference
- Fits most standard detachable blade clippers
- New innovative packaging
- New 6 pack overpack



Ultimate Competition Blades

| | | |
|----------|------------------------|------------|
| 2372-500 | #5F Full Coarse | \$39.55/ea |
| 2360-500 | #9 Medium | \$32.55/ea |
| 2367-500 | #7 Skip Medium Coarse | \$36.95/ea |
| 2368-500 | #7F Full Medium Coarse | \$36.95/ea |
| 2370-500 | #5WF Full Coarse Wide | \$42.95/ea |
| 2362-500 | #8.5 | \$32.55/ea |
| 2371-500 | #5 Skip Coarse | \$39.55/ea |
| 2374-500 | #4 Skip Extra Coarse | \$42.95/ea |
| 2375-500 | #4F Full Extra Coarse | \$42.95/ea |
| 2376-500 | #3 Full Coarse | \$46.75/ea |
| 2377-500 | #10W Extra Wide | \$39.55/ea |
| 2450-500 | X-Blend | \$56.75/ea |
| 2430-500 | X-Block | \$56.75/ea |

Wahl Ultra Surgical Ultimate Blades

| | | |
|-----------|------------|------------|
| 2358-2101 | #10 Medium | \$30.95/ea |
| 2355-2101 | #30 Fine | \$30.95/ea |
| 2350-2101 | #50 | \$30.95/ea |
| 2352-2101 | #40 | \$30.95/ea |
| 2357-2101 | #15 Medium | \$30.95/ea |

Clipper Cleaner

Refillable pump spray bottle. Easily cleans and disinfects you clipper blades with one easy spray

| | | |
|----------|-------------|------------|
| 3701 | 8oz | \$11.35/ea |
| 3701-300 | 24oz Refill | \$20.55/ea |

Oster Blade Wash®

Sharp move using Blade Wash® to clean your blades. It easily flushes away hair that accumulates on blades and is also superb for lubricating blades and removing factory-applied preservatives.

OSTER-WASH \$7.32/ea

Clipper Holder

Conveniently keeps clipper within easy reach and protects blade and clipper from damage. Can be installed at your station or work area. Easy install.

PL300 Plastic \$11.64/ea

Oster Kool Lube 3®

Kool Lube 3 is a quick, effective lubricant that provides instant cooling, lubrication, and clearing for your clipper blades. Simply spray Kool Lube 3 through the clipper blades occasionally during the time you are clipping for reduced friction, heat, and less blade wear without a heavy residue of oil.

OSTER-KOOL Cleaner, Lubricant, Coolant \$9.50/ea

Clipper Blade Oil

The standard in the clipper cutting industry. One drop of wahl oil after each cut translates into a long blade life.

3310 4oz \$3.15/ea





Cat Claw Clipper

This clipper is manufactured with surgical steel to give the cat or kitten's nail a clean sharp cut.

AP-F00455 \$4.96/ea

Safety Pet Nail Clipper

This nail clipper can be used on dogs, cats, birds and other household pets. It has a safety bar to prevent over-cutting and the blade is guaranteed for three years against dulling.

AP-F00463 \$4.96/ea

Nail Trimmer for Dogs

These trimmers have been designed with stainless steel surgical blades which offer many years of sharp, clean cutting.

AP-F00401 Small and Medium Breeds \$6.99/ea

AP-F00452 Large Breeds \$6.99/ea



Cat Nail Clipper

Cat Claw Scissors especially designed for cutting the thin and fragile nails of cats and small exotics. Gives a good clean cut without tearing or shredding.

JOR84C Stainless Steel, 3" (7.5cm). \$6.00/ea



Jorvet Heavy Duty Nail Trimmer

Smaller and lighter version of JOR84h. Safety lock opening 5/16". Perfect for small and medium-sized breeds.

JOR84HR Trimmer, 6 1/2"L \$10.20/ea

JOR84HSR Trimmer, 6 1/2"L \$10.50/ea



Jorvet Heavy Duty Nail Scissors

A must for trimming nails of bigger breeds. Nylon handle. Blade opening 7/16" with safety lock.

JOR84H Stainless Steel Blades, 6 1/2"L \$10.20/ea



Resco Nail Trimmer

Regular or jumbo nail trimmer. Replacement blades fit both trimmers.

727 Regular \$8.49/ea

747 Jumbo \$8.75/ea



Terminator Nail Trimmer

This nail trimmer will cut through the heaviest of nails with ease, making the trimming of even the largest, toughest nails simple. About 1/3 larger than the JOR84h heavy-duty nail trimmer.

JOR84HX \$13.50/ea

JorVet



Guillotine Style Nail Trimmer

JOR307D1 Spare Blade. \$0.90/ea

JOR307 5"L. \$5.10/ea

JorVet



Heavy Duty Nail Trimmer

Smaller and lighter version of JOR84h. Safety lock opening 5/16". Perfect for small and medium-sized breeds.

JOR84HS Small, 5". \$9.90/ea

JorVet



Lint Pick Up Device

Use this handy item to remove lint from fabric clothing and other surfaces without messy adhesive residue. Double reversible tape, perforated every 4" for fast removal and zero waste.

LINT Roller complete \$2.99/ea

LINT-R Refill \$2.29/ea



NEW

Super Nail Clipper

This nail clipper was designed especially for large breed dogs. It has a larger cutting blade that is guaranteed against dulling for three years. This clipper is recommended by veterinarians, groomers and professional handlers.

AP-F00464 For large breed dogs. \$11.26/ea



Super Mini Nail Clipper

AP-F00465 with Safety Bar \$7.48/ea

Terry Towel

Thirsty terry hand towels and bath towels. Designed to fit every need and every budget.

TOWEL-B Terry Bath Towel, 1 Dozen \$22.99/ea

TOWEL-H Terry Hand 12" x 12.75" LBS., 1 Dozen \$2.99/ea



Grooming - Tubs, Tables & Accessories



Walk-In Stainless Steel Tub

All parts are stainless steel. Great for all breeders. Fabricated with heavy 18 gauge 304 stainless steel. Swing-in swing-out 18 gauge stainless ramp. 16 gauge round tubing leg and frame assembly. Removable stainless entry allows complete view. Accommodates breeds up to 300 lbs. Available in 48" or 58" lengths. Plumbing on right or left side. Clean out hair trap. 4 back wall eye-hooks.

A048U 48" x 24" x 28"H \$3,109.05/ea



Walk-In Stainless Steel Tub

All parts are stainless steel. Great for all breeds. Fabricated with heavy 18 gauge 304 stainless steel. Swing-in swing-out 18 gauge stainless ramp. 16 gauge round tubing leg and frame assembly. Removable stainless entry allows complete view. Accommodates breeds up to 300 lbs. Available in 48" or 58" lengths. Plumbing on right or left side. Clean out hair trap. 4 back wall eye-hooks.

A058K 58" x 24" x 28"H \$3,208.28/ea



Grooming Table

Designed to last a lifetime, this stout grooming table features tubular legs with bright chrome plating. Tabletop is made of 3/4" solid plywood (not particle board) and finished with easy-to-clean no-skid vinyl. A piece of 1" extruded plastic molding makes for a reliable and attractive table.

490P 18" X 30" X 33"H \$109.65/ea
500P 24" X 36" X 30.5"H \$115.80/ea
500-48P 24" x 48" x 30.5"H \$129.75/ea



Mobile Grooming Table

This mobile/collapsible grooming table comes with folding chrome, tubular legs equipped with large casters which allows the table to be used as a dolly. Tabletop is plywood with no-skid vinyl. 150lbs test weight.

505PW 24" x 36" x 30.5"H \$153.00/ea



Grooming Table Arm

These grooming posts come in two lengths and are available with or without clamps. Type without clamp is for use with tables that have the post going through.

500-36 36" Through Table Arm \$25.00/ea
500-48 48" Through Table Arm w/Clamp \$31.65/ea
501GA-36 36" Arm and Clamp \$30.45/ea
501GA-48 48" Arm and Clamp \$32.40/ea



White's Toenail Scissors

J0R84 4" \$6.60/ea



Hair Trap

See those costly, time consuming drain clogs before they happen. The hair trap is an affordable alternative to high plumbing costs. Just screw off the special adapter cap and remove the double strainer and the clog from the tube. Easy to install and fits all types of tubs. Can be used for dip recovery.

PL600 PVC \$70.39/ea



Groom-Aid Spray

Evenco Groom-Aid Spray 7.3 oz for veterinary use contains a lanolin derivative which adds a luster and sheen to your animal's coat. Groom-Aid helps keep the animal's coat tangle-free. This non-greasy formula absorbs quickly. When applied after bathing, Groom-Aid makes your animal's coat easy to comb, brush and groom. Groom-Aid contains isopropyl alcohol and mineral spirits.

RXGROOM-AID 7.3oz spray \$5.00/ea



Grooming Noose

These nylon grooming nooses are used for controlling an animal while it is being groomed. Simply place the noose on the animal and attach the noose to a grooming post.

CP82114 Blue \$1.50/ea
CP82115 Red \$1.50/ea



Pet Bath Hose

Lightweight durable 5 ft stainless steel hose and spray head. Light enough to be used all day. Spray force and pattern can be altered to work more efficiently.

PL972 Spray whose \$98.00/ea



Hair Strainer

Catches fine dog and cat hairs and keeps them out of the drain pipes. Efficient nonclog design. Use on any 3 1/2" strainer.

PL500 3 1/2" Plastic \$14.56/ea





Magic Coat PLUS Flea and Tick Shampoo

This extra strength formula was made specifically for dogs with a heavy infestation of fleas, ticks or lice. This shampoo not only kills all those little pests, it also leaves your dogs coat looking shiny and smelling great.

AP-F10610 16oz \$5.50/ea



Magic Coat Flea and Tick Shampoo

This shampoo has been formulated to kill fleas, ticks, and lice on dogs, cats, puppies and kittens without harming their coat or skin. It is a rich, highly concentrated shampoo that will give your pet a lustrous, fresh smelling coat.

AP-F10620 16oz \$5.40/ea



Magic Coat Puppy Tearless Shampoo with Aloe Vera, Protein and Lanolin

This shampoo will not irritate your puppy's eyes but it will leave the coat shiny, fresh and easy to manage. It cleans gently and thoroughly while eliminating puppy odors.

AP-F10650 16oz \$3.98/ea



Magic Coat Protein Tearless Shampoo

Give your dog's coat an amazing shine with this conditioning shampoo made for dogs and puppies. It will bring out your dog's natural lustre without irritating his skin or eyes.

AP-F10640 12oz \$3.75/ea



Crystal Eye

Crystal Eye Tear Stain remover is safe for dogs and cats. Quickly and easily removes the brown staining around the eyes and in skin folds.

AP-F01738 4oz \$4.14/btl



Four Paws Fresh Essence Cologne

Completely deodorize your pet's coat with this long-lasting, refreshing fragrance.

AP-F10540 6oz \$5.58/ea



Four Paws Cologne

For the pet that has everything. An exciting spray-on fragrance that lasts up to 24 hours.

AP-F10500 3oz \$5.94/ea



Four Paws Instant Dry Shampoo & Deodorant

Now you can shampoo your pet anytime, anywhere, faster and easier than ever before. Used as a whitener-cleaner by professionals, this product removes greasy and grimy substances from fur. No water is required. It will leave your pets coat lustrous, pleasantly-scented and easy to manage.

AP-F10520 7oz \$4.60/ea



Chloraderm Shampoo

This shampoo is a gentle antimicrobial shampoo safe for most animals. It has chlorhexidine gluconate for antimicrobial activity. It also has moisturizers and a fresh scent to leave the coat looking, smelling and feeling its best.

RXCHLORADERM 1%, 8oz \$2.99/btl



Malacetic Shampoo

This patented, pleasant smelling, acetic acid/boric acid shampoo is a revolutionary breakthrough in topical dermatology therapy. It is all natural and contains no soaps, dyes or animal protein. Acetic and Boric Acids have been used since medieval times for various maladies. Acetic acid is a known conditioner for hair leaving it clean, soft and lustrous while removing soap, scales, dandruff and other residue.

RXMAL-SHM16 16oz \$9.99/btl
RXMAL-SHAMG Gallon \$59.99/gl



Malacetic Shampoo

RXMAL-SHM8 8oz \$14.29/btl

Malacetic Otic

RXMALOTIC-4 4oz \$6.32/btl
RXMALOTIC-16 16oz \$14.99/btl



Malacetic Wet Wipes

RXMAL-WIPE 5" x 9" Wipes, 25/pack \$7.29/pk



Malacetic Conditioner

MalAcetic is now available in an easy to use leave-on, dry-on, ALCOHOL and PEG FREE Conditioner. Convenient to use after using ANY shampoo or by itself for the busy pet owner. This patented, pleasant smelling, acetic acid/boric acid Conditioner is a revolutionary breakthrough in topical dermatology therapy. DermaPet Hypo-Allergenic Conditioner. It is all natural and contains no alcohol or polyethylene glycol which are both found in competitive products containing miconazole.

RXMAL-CON8 8oz \$7.10/btl





biotene[®] veterinarian

Biotene Antiseptic Oral Gel

RXBIOGEL-6 1oz tube, 6 tubes/pk

\$39⁹⁹/pk

Biotene Maintenance Kit

RXBIOKIT-6 6 kits/pk

\$26⁹⁹/pk



Yuk-2e Anti-Lick Gel

RXYUK-0.5 0.5oz

\$4⁹⁹/btl



Bitter Rid Spray

Bitter Rid Spray discourages animals from licking, biting and chewing. It tastes so bad they don't want to do it. It is non-flammable, non-poisonous, non-staining and pleasant smelling. You can apply it to bandages, casts, hair or household furniture.

RXBIT-4 4 oz bottle \$2.71/btl



Forbid

FOR-BID stops coprophagy (pets eating stool). Vegetable protein and sodium glutamate work in the digestive system to give stools a bad taste.

RXFORBID-12 12/pack \$21.00/pk



Omega 3 Gel Caps

Omega 3 fatty acids help support healthy skin, coat, joints and heart!

RXOMESD-60 Small Dog, 60 gelcaps \$4.99/btl

RXOMELD-60 Large Dog, 60 gelcaps \$5.99/btl



Eicosaderm

RXEICO-8 EPA 360mg/DHA 240mg, 8oz

\$12²⁵/btl



Cat Lax

A palatable formula for the prevention and elimination of hairballs in cats.

RXCAT-LAX 2oz \$2.31/ea



CET Fingerbrush with Paste

RXCET-12 1 brush, 12gm paste

\$4⁴⁰/ea

Chlorhexidine and Zinc Oral Spray

RXCHZN-8 8oz bottle

\$4⁵⁰/btl

Clean and Fresh Oral Spray

RXCLEAN-8 0.1%, 8oz

\$4⁵⁰/btl

PetDental Care Kit

The PetDental Care Kit comes with a 2.5oz tube of toothpaste, a finger brush to massage the gums, and a long handle, two sided toothbrush. The toothbrush is specially angled to make brushing your pets teeth easier. Keep your pets healthy and smelling great!

AP-F41020 dogs \$6.22/ea
AP-F41022 cats \$5.05/ea



PetDental Toothpaste

PetDental Toothpaste with fluoride is recommended by veterinarians to help fight plaque and tartar build-up, combat gum disease, and control unpleasant breath.

AP-F41012 dogs, 2.5 oz \$3.42/ea
AP-F41015 cats, 2.5oz \$3.42/ea



Tapeworm (Praziquantal) Tablets

Dogs and cats can be infested with two types of tapeworms. Fleas carry the most common type, and rodents carry the less common type. Until recently, the only effective control has required a prescription. However, this drug (Praziquantal) is now available without a prescription, and is 100% effective in ridding your pet of both types of tapeworms.

RXOTC8783 Feline, 3 tablets/bottle \$10.50/btl
RXOTC8785 Canine, 5 tablets/bottle \$16.99/btl



Pet Pill Crusher

Many times a tablet or pill is too large for a pet to swallow. In addition, a pill can be crushed to hide in the animal's food or in a treat. This pill crusher works by dropping the pill into the clear chamber and screwing the top portion directly into it. It also has a handy storage area in the lid to keep extra tablets close by. Top and bottom have raised knurled ridges for easy tightening. Made of high impact plastic.

JOR613 Packaged in blister pack display. \$2.55/ea **JorVet**



No returns on pharmaceuticals • Prices subject to change without notice. Shipping charges for refrigerated items are a flat charge based on your shipping zone. Customer accepts full responsibility for condition of products upon receipt.

13822 WEST BOULTON BLVD. METTAWA, IL 60045

WWW.SHOPMEDVET.COM

Phone 800-544-7521

159

Fax 800-204-2177



Dentacetic Dentees Chews

Abrasive action and patented ingredients, HMP and acetic acid, help decrease buildup of dental plaque and block formation of tartar. The chewing physically removes both! Also brightens teeth. All in one delicious chew!

RXDEN-CHEW 10oz pack \$10.08/pk

Dentacetic Dentees Stars

RXDEN-STARS 4oz pack \$4.79/pk

Dentacetic Gel

An acetic acid tooth and gum gel with sodium hexametaphosphate. The former creates a multifunctional dental product which degrades better, brightens teeth and has excellent antimicrobial effects with fewer side effects (it does not stain). The sodium hexametaphosphate is to prevent tartar and calculi formation.

RXDEN-GEL 2oz \$3.99/btl

Dentacetic Wipes

RXDEN-WIPES 25 wipes/pack \$5.99/pk



Jorvet Walka Boot

JorVet

Protective water resistant boot made with a durable neoprene shell. The boot has a moisture absorbing liner that keeps pets feet drier. Rubber sole provides support and insulation. Machine washable, line dry. ** Due to the risk of infection, Jorvet regrets that it cannot accept a return of this product once the product has been placed on an animal.

JOR456W Small \$15.00/ea
 JOR456X Medium \$16.50/ea
 JOR456Y Medium Large \$19.50/ea
 JOR456Z Large \$21.00/ea



Web Master Harness

JorVet

The safe use of hydrotherapy should include either a float coat or, for advanced swimmers, a safety harness. No patient should be swimming with just a single collar. The Web master Harness has a three point system with a "D" ring. The lifting handle is low profile with a quick release snap. The harness is made of heavy-duty nylon material for durability. A secure but comfortable harness designed especially for hydrotherapy. Color is red and black.



JOR979A XX Small, Primary Measurement 12" - 19", Dog Length 10" \$62.00/ea
 JOR979B XSmall, Primary Measurement 17" - 24", Dog Length 12 3/4" \$62.00/ea
 JOR979C Small, Primary Measurement 18" - 30", Dog Length 15 1/2" \$62.00/ea
 JOR979D Medium, Primary Measurement 23" - 36", Dog Length 19" \$62.00/ea
 JOR979E Large, Primary Measurement 31" - 48", Dog Length 22" \$62.00/ea
 JOR979S Set of 5 \$220.00/set

Thermo Pet Mat

JorVet

A less expensive warming unit, consisting of a blue flexible 6-watt warming pad placed inside a washable faux lambskin cover. The convenient 14" x 28" size fits all standard cages. The pad is preset to be thermostatically controlled to 102°. U.L. approved. Limited one-year warranty.

JOR917 14" x 28" \$45.90/ea



Jorvet Deluxe Lectro-Kennel

The new Lectro-Kennel has a digital temperature control built right into the pad.

- Adjustable from 80° to 100°F
- Can be read in either Celsius or Fahrenheit
- Includes sheepskin cover

Constructed of rugged, brown ABS plastic, the pad is completely water tight, easily cleaned, suitable for all makes of cages as well as kennel runs. Lectro-Kennel is equipped with a steel wrapped abrasion resistant electrical cord. One-year warranty.

JOR916B Large, 22 1/2" x 28 1/2", 80 watt \$158.00/ea

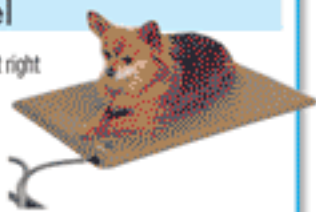

Jorvet Lectro Cover

JorVet

This optional faux lambskin cover is soft, comfortable and machine washable. The cover slips over the Lectro-Kennel.

JOR916X Small \$15.60/ea
 JOR916Y Medium \$19.50/ea
 JOR916Z Large \$22.50/ea



Jorvet Evan's Mobility Cart

Veterinarians frequently encounter patients that are non-ambulatory, either temporarily or even permanently. Providing these patients with the proper support is a difficult challenge, yet necessary to get the patient up and moving to achieve maximum rehabilitation. The Evan's mobility cart was designed by a veterinarian to help any animal that is "down" on hind or front limbs due to post surgery or trauma, paralysis, hip dysplasia or other arthritic conditions. **The cart features:**

- Tough, durable framework constructed of powder coated lightweight tubular steel
- Four legs with casters with bearings, allowing 360° range of motion
- Reduced risk of cart turnover
- Washable and adjustable nylon mesh saddle support

JOR865A Medium \$336.00/ea
 JOR865B Large \$350.00/ea
 JOR865C X-Large \$364.00/ea
 JOR865 Small \$308.00/ea



Web Sling Only for Cart

JOR865AW Medium \$43.50/ea
 JOR865BW Large \$58.50/ea
 JOR865CW X Large \$63.00/ea
 JOR865W Small \$39.00/ea



Pet, Grooming & Restraints

Pets - Medical Products

Jorvet Pet Nursing Kit

This baby bottle is ideal for supplementing milk to newborn small pets. The clear silicone nipple is very long-lasting. The bottle has clearly marked measurements on its side. Also includes bottle cleaning brush and extra silicon nipple

| | | |
|---------|-------|-----------|
| JOR787 | 50ml | \$2.40/ea |
| JOR787L | 150ml | \$2.70/ea |



Jorvet Mothering Kit

This unique kit features a tiny syringe gun with three interchangeable tiny clear silicone nipples. The concept is to draw milk up into the tiny syringe then attach a nipple. The milk is slowly administered as the newborn starts to suckle. Allows the feeding of the smallest of animals.

| | | |
|--------|--|-----------|
| JOR788 | Kit includes clear silicone nipples and syringe. | \$1.50/ea |
|--------|--|-----------|



JorVet

Cut-Pad Dog Pad Protector

An All-Natural treatment for wound care. Creates a protective barrier, cleans the wound, and aids rapid healing.

| | | |
|-----------|-----|------------|
| RXCUT-PAD | 4oz | \$5.00/btl |
|-----------|-----|------------|

Cut-Heal Wound Spray

| | | |
|-------------|-----|------------|
| RXCUT-SPRAY | 4oz | \$6.79/btl |
|-------------|-----|------------|

Plastipad Urethane Pad Repair Kit

| | |
|----------|------------|
| JOR783RK | \$18.00/ea |
|----------|------------|



All Purpose Apron

This royal blue nylon cloth apron has an adjustable neck strap and a quick release buckle. Comfortable fit. Front dual pockets.

| | | |
|---------|-------|------------|
| JOR171 | Small | \$12.00/ea |
| JOR171A | Large | \$12.00/ea |



Jorvet Pet Mitts

The perfect item for when there is an accident in the exam room, waiting room, or kennel. The Pet Mitt could also be sold to clients for use around the house. In addition, the Pet Mitt can be used for fecal samples. Conveniently packaged in a dispensing box of 100. Brown plastic film glove is 18" long. The glove can be reversed and knotted for hygienic disposal after specimen retrieval.

| | | |
|---------|--------------------------|------------|
| JOR300X | In dispensing box of 100 | \$10.00/bx |
|---------|--------------------------|------------|



JorVet

FREE



Your choice... With qualifying purchase
See Inside cover for details, certain restrictions apply...

Jorvet Canine Sidebars **JorVet**

A new restraint bar designed to prevent the patient from turning and chewing or licking any wound located anywhere on the body behind the shoulders. The animal's head is free to move about to eat and drink. The lightweight aluminum bar is configured to go over the top of both shoulders and then directed backward past the rib cage. It is held in place with adjustable Velcro straps along the belly and over the front of the chest. Developed in conjunction with the Colorado State University School of Veterinary Medicine. (NOTE: Not suitable for front leg wounds.)

| | | |
|----------|--|-------------|
| JOR1078A | Jack Russell - rod = 0.65cm dia - xls chart; A = 7" B = 4" C = 7" | \$23.25/ea |
| JOR1078B | Beagle - rod = 0.95cm dia - xls chart; A = 10" B = 5" C = 10" | \$27.00/ea |
| JOR1078D | Newfoundland - rod = 0.95cm dia - xls chart; A = 20" B = 10" C = 20" | \$39.00/ea |
| JOR1078C | Labrador - rod = 0.95cm dia - xls chart; A = 16" B = 10" C = 16" | \$30.00/ea |
| JOR1078S | set of all 4 | \$119.00/ea |



13822 WEST BOULTON BLVD. METTAWA, IL 60045

WWW.SHOPMEDVET.COM

Phone 800-544-7521

161

Fax 800-204-2177

Pets - Ear Treatments & Paw Protectors

Oticare P Ear Powder

Oticare P Ear Powder for dogs and cats helps keep the ears dry and reduces ear odor. It is also used to help remove hair from the ear canals of dogs.

RXOTIC66606 6 gram \$3.50/btl



Oticlean A Ear Cleaner

For routine cleaning and odor control of the ear canal.

RXOTIC66704 4oz \$4.50/btl



Otisothe II Ear Cleaner

For routine cleaning and odor control of the ear canal.

RXOTIC66716 16oz \$8.99/btl



Ear Cleaner with Aloe

RXOTIC-JC 4oz bottle

\$245/btl
Not Pictured

Ear Mite Killer

Ear mite killer with aloe for use in cats, dogs and horses. Kills on contact.

RXEARMITE-6 6oz \$5.99/btl



Otomax

Otomax is an ointment used to treat ear infections. It is a combination steroid, antibacterial, and antifungal ear medication labeled for use in dogs.

RXOTOMAX30 6 x 30ml/pack \$158.99/pk

Feliway

Feliway® is a synthetic copy of the feline facial pheromone, used by cats to mark their territory as safe and secure. By mimicking the cat's natural facial pheromones, Feliway® creates a state of familiarity and security in the cat's environment. As a result, Feliway® can be used to help comfort and reassure cats.

RXFELWAY-REF Refill, 48ml \$14.99/ea



Styptic Powder

A safe, quick styptic powder aid with antiseptic to stop bleeding caused by clipping nails, dew claws, ear cropping, docking tails, trimming beaks and minor cuts.

CP4100 1/2 Oz Ea Vet Use \$2.75/ea

CP4101 1.25 Oz Ea Vet Use \$5.99/ea

CP4102 6 Oz Ea Vet Use \$11.50/ea



Kwik-Stop Styptic Powder

Kwik Stop forms an instant barrier to stop bleeding fast. Used as an aid to stop bleeding caused by clipping nails, docking tails and minor superficial cuts in dogs and cats.

RXXKWIK-STOP 0.5 oz (14g) \$6.98/ea

RXXKWIK-STOP1.5 1.5 oz (42g) \$12.36/ea



Jorvet TheraPaw Protector

Padded and supportive boots for painful or injured paws provides superior protection against environmental hazards. Recommended uses include: paw and bandage protection after surgery; management of cuts, burns, torn tendons and ligaments; ideal for hydro-therapy and rehabilitation; excellent traction for unstable dogs. **Features include:**

- Ultra-cushioned interior padded base
- Rubberized, waterproof, tractioned sole
- Breathable Airprene sock/sleeve
- Double-closing Velcro lapels for additional security
- Seamless interior
- Quick drying and easy maintenance

Jorvet



| | | |
|-----------|---|------------|
| JOR864A | Small, Paw Length 2 1/2", Paw Width 2", Weight 15-35 lbs., Wrist/Ankle Circumference Up to 3 1/2", Wrist/Ankle Height 2 1/4" | \$18.00/ea |
| JOR864AB | Small-Medium, Paw Length 2 3/4", Paw Width 2 1/4", Weight 30-50 lbs., Wrist/Ankle Circumference Up to 4 1/2", Wrist/Ankle Height 2 3/4" | \$18.00/ea |
| JOR864ABB | Small-Medium #2, Paw Length 3 3/4", Paw Width 2 1/2", Weight 40-70 lbs., Wrist/Ankle Circumference Up to 4 1/2", Wrist/Ankle Height 3" | \$19.50/ea |

| | | |
|----------|--|------------|
| JOR864B | Medium, Paw Length 3 1/2", Paw Width 2 3/4", Weight 60-90 lbs., Wrist/Ankle Circumference Up to 5", Wrist/Ankle Height 3" | \$19.50/ea |
| JOR864BC | Medium-Large, Paw Length 3 3/4", Paw Width 3", Weight 80-110 lbs., Wrist/Ankle Circumference Up to 5 1/2", Wrist/Ankle Height 3 3/4" | \$21.90/ea |
| JOR864C | Large, Paw Length 4 1/4", Paw Width 3 1/2", Weight 100-130 lbs., Wrist/Ankle Circumference Up to 6 1/2", Wrist/Ankle Height 4 1/4" | \$21.90/ea |



VetMed Care Protective Bodysuit

This new line of protective body wear has been used extensively by veterinarians throughout Europe. A wide range of applications has evolved literally from head to tail on a whole host of different species. Traditional methods of wound protection such as "E" collars, and adhesive tapes have several known disadvantages. The VetMedCare protective body wear offers a great alternative to wound protection. Body suits are easy to handle and protect sensitive areas from dirt, scratching and licking. Thoughtful design provides front and back leg openings that have special flat and stretch seams which help avoid limb irritations or abrasions. The belly is fully smooth, as the seam is along the back. Anatomical differences require consideration of both male and female designs.

Female

| | | |
|----------|--|-------------|
| JOR1055A | X-Small, Neck 6-8", Chest 8"-10", Distance Between Front/Back legs 9.5" | \$24.00/ea |
| JOR1055B | Small, Neck 8-10", Chest 12"-16" Distance Between Front /Back Legs 15" | \$27.00/ea |
| JOR1055C | Medium, Neck 10-14", Chest 16-20", Distance Between Front/Back Legs 18" | \$27.00/ea |
| JOR1055D | Large, Neck 14-18", Chest 18"-24", Distance Between Front/Back Legs 19.75" | \$28.00/ea |
| JOR1055E | X-Large, Neck 18-22", Chest 24"-30", Distance Between Front/Back Legs 23.5" | \$36.00/ea |
| JOR1055F | XX-Large, Neck 22-24", Chest 26"-35", Distance Between Front/Back Legs 26.5" | \$29.60/ea |
| JOR1055G | Leg/Head Extremity, set of 4 | \$36.00/ea |
| JOR1055S | All 6 sizes, both female and male bodysuits and all 4 sizes of leg/head extremities 18 pieces, Snap connections. | \$316.00/ea |

Material and Sizes:

- Very Elastic, stretches in all directions for a comfortable fit
- Wash and wear material: easy to clean, just hang to dry
- Can be trimmed to custom size or shape and not fray or run
- Wide range of sizes (6) to fit all small animals
- Green/blue color is neutral surgery color

Some applications:

- Surgical sites
- Chest drains
- Aural hematomas
- PEG tubes
- Open wounds
- Additional protection over bandaged wounds
- Can actually hold telfa pads tightly in place through use of simple snaps
- Provides cosmetic benefits over unsightly wounds/injuries
- Clients love them and so do the patients!
- Leg and extremity protection:
 - The special elastic tube-shaped material can cover leg or head wounds
 - They attach to the body suit by light-weight simple snaps
- Head protection: trim in eyes and ears and/or trim to length desired



Cone shaped product is designed for rear leg

Male

| | | |
|-----------|--|------------|
| JOR1055AM | X-Small, Neck 6-8", Chest 8"-10", Distance Between Front/Back Legs 9.5" | \$23.00/ea |
| JOR1055BM | Small, Neck 8-10", Chest 12"-16" Distance Between Front /Back Legs 15" | \$23.00/ea |
| JOR1055CM | Medium, Neck 10-14", Chest 16-20", Distance Between Front/Back Legs 18" | \$28.50/ea |
| JOR1055DM | Large, Neck 14-18", Chest 18"-24", Distance Between Front/Back Legs 19.75" | \$33.00/ea |
| JOR1055EM | X-Large, Neck 18-22", Chest 24"-30", Distance Between Front/Back Legs 23.5" | \$36.00/ea |
| JOR1055FM | XX-Large, Neck 22-24", Chest 26"-35", Distance Between Front/Back Legs 26.5" | \$29.60/ea |





The Walkabout™ Harness **JorVet**

The options for a paralyzed dog or cat are limited. Their quality of life depends upon the owner's ability to deal effectively with their situation. Euthanasia often is chosen. Today's pet owner wants other choices, and the Walkabout™ provides the alternative. The design and construction of the Walkabout™ harness provides the balance and support necessary for your pet to lead a happier, healthier and cleaner life. Use of the Walkabout also can help minimize the owner's back strain that can result from lifting and carrying the pet. Used by over 20 veterinary teaching institutions like the Animal Medical Center in New York, and the Research Center for Paralysis at Purdue University.

- **Front Harness:** A smooth, semicircular neckline allows your pet to breathe comfortably, while simultaneously supporting his/her front end.
- **Combination Harness:** Double harnessing may provide the safest and most comfortable means to transport your pet. Measurements are necessary for both front and back. Special Order.
- **Amputee Harness:** A custom design provides a harness for pets who have lost a limb. Special Order. Rear Harness.



| | | |
|---------|--|--------------|
| JOR456A | X-Small, A 9" - 15", B 3" - 6" | \$40.00/ea |
| JOR456B | Small, A 10" - 16", B 3" - 8" | \$42.00/ea |
| JOR456C | Medium, A 15" - 12", B 6" - 12" | \$53.00/ea |
| JOR456D | Medium-Large, A 20" - 29", B 11" - 15" | \$65.00/ea |
| JOR456E | Large, A 24" - 31", B 14" - 17" | \$78.00/ea |
| JOR456F | X-Large, A 31" - 35", B 16" - 19" | \$87.00/ea |
| JOR456S | Set of 6 | \$295.00/set |

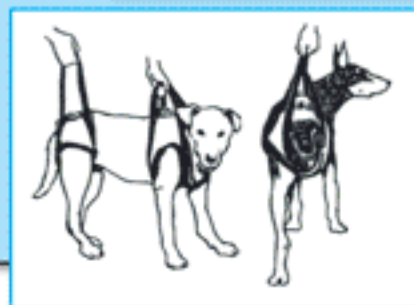
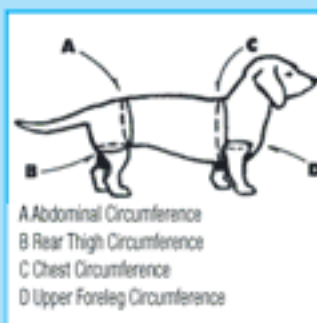

Deluxe Double Door Crate

The K-9 Keeper Deluxe Dog Crate comes fully assembled. It is completely collapsible for easy carrying and storage. There are two full doors, one on the front and one on the side, for added convenience. The ABS plastic tray on the bottom removes easily for effortless cleaning.

| | | |
|-----------|------------------------------------|-------------|
| AP-F57419 | 19" x 12" x 15" | \$42.99/ea |
| AP-F57424 | 24.25 x 17 x 20.25" | \$49.99/ea |
| AP-F57430 | 30" x 21" x 24" with divider panel | \$67.32/ea |
| AP-F57436 | 36" x 23" x 26" | \$76.24/ea |
| AP-F57442 | 42" x 28" x 31" | \$95.99/ea |
| AP-F57448 | 48" x 30" x 33" with divider panel | \$125.00/ea |

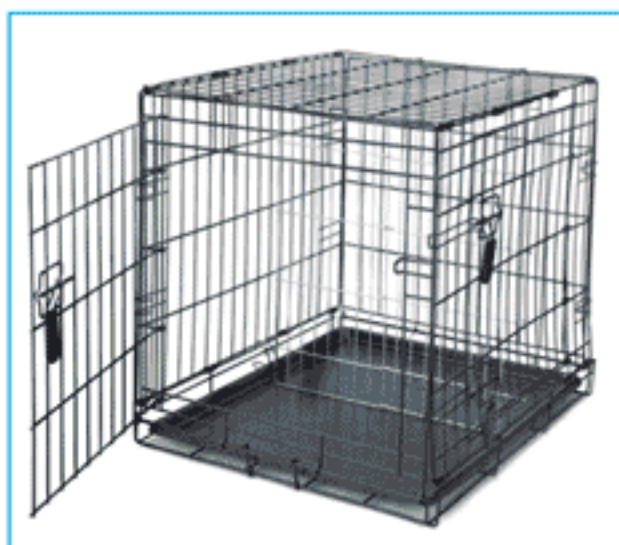



ID-Band



Ideal for short or long term positive identification of animals, easy to apply. Each carton includes a permanent marking pen. Can also use ball point pen or pencil. Pressure sensitive adhesive tabs ensure band will remain on patient until removed. Three sizes, solid or mixed colors are available.

| | | |
|-----------|---------------------------------|------------|
| EJIDY20 | Yellow, 20" x 1", 500/cs | \$41.45/cs |
| EJIDKT333 | White, 1 Marker, 250" Tape Roll | \$27.58/cs |
| EJIDM30 | Mixed Colors, 30" x 1", 100/cs | \$21.83/cs |
| EJIDB30 | Blue, 30"x1", 100/cs | \$21.83/cs |
| EJIDW10 | White, 10" x 1", 500/cs | \$36.96/cs |
| EJIDR20 | Red, 20" x 1", 500/cs | \$41.45/cs |
| EJIDG10 | Green, 10" x 1", 500/cs | \$36.96/cs |
| EJIDT250 | White, Sure Hold Tape, 250" | \$6.36/cs |
| EJIDG30 | Green, 30" x 1", 100/cs | \$21.83/cs |
| EJIDW20 | White, 20" x 1", 500/cs | \$41.45/cs |
| EJIDB10 | Blue, 10"x1", 500/cs | \$36.96/cs |
| EJIDW30 | White, 30" x 1", 100/bx | \$21.83/cs |
| EJIDY30 | Yellow, 30" x 1", 100/cs | \$21.83/cs |
| EJIDO30 | Orange, 30" x 1", 100/cs | \$21.83/cs |
| EJIDB20 | Blue, 20"x1", 500/cs | \$41.45/cs |
| EJIDG20 | Green, 20" x 1", 500/cs | \$41.45/cs |
| EJIDO20 | Orange, 20" x 1", 500/cs | \$41.45/cs |
| EJIDR10 | Red, 10" x 1", 500/cs | \$36.96/cs |
| EJIDY10 | Yellow, 10" x 1", 500/cs | \$36.96/cs |
| EJIDO10 | Orange, 10" x 1", 500/cs | \$36.96/cs |
| EJIDR30 | Red, 30" x 1", 100/cs | \$21.83/cs |

Manufactured with strong and tough spun bonded olefin. They are very soft and comfortable. Colored bands with white on the reverse. Bands fit most animals. For larger animals two bands may be attached. 500 per box.

| | | |
|----------|-----|------------|
| EJIDM-10 | 10" | \$37.99/bx |
| EJIDM-20 | 20" | \$41.99/bx |

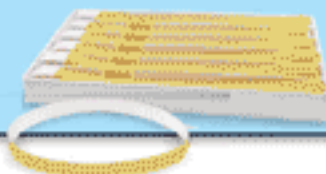

Ejay Haylo

Ejay Haylo the next generation of effective humane protection for post operative patients that require the area behind patients neck to be protected from patients muzzle.



| | | |
|----------|--|------------|
| EJHAY625 | 9" Width, 10"-21.50" Neck Circumference | \$5.33/ea |
| EJHAY007 | 2 of each size, except HAY105 | \$54.95/ea |
| EJHAY312 | 5.50" Width, 8"-15" Neck Circumference | \$3.16/ea |
| EJHAY105 | 3" Width, 5"-12", Neck Circumference | \$2.83/ea |
| EJHAY210 | 4" Width, 7"-13.50" Neck Circumference | \$3.00/ea |
| EJHAY415 | 7" Width, 9"-17" Neck Circumference | \$4.16/ea |
| EJHAY520 | 8" Width, 9"-19.50" Neck Circumference | \$4.41/ea |
| EJHAY730 | 12" Width, 14"-28.50" Neck Circumference | \$6.00/ea |

Kong ZoomGroom

Removes loose hair like a magnet, stimulates capillaries and natural oil production for healthy skin and coats.

| | | |
|-------|--|-----------|
| EJZG2 | Boysenberry, Soft, Flexible, Groom & Shampoo | \$5.60/ea |
| EJCZG | Cat, Soft, Flexible, Groom & Shampoo | \$4.53/ea |
| EJZG1 | Raspberry, Soft, Flexible, Groom & Shampoo | \$5.60/ea |
| EJZG3 | Lemon, Soft, Flexible, Groom & Shampoo | \$5.60/ea |

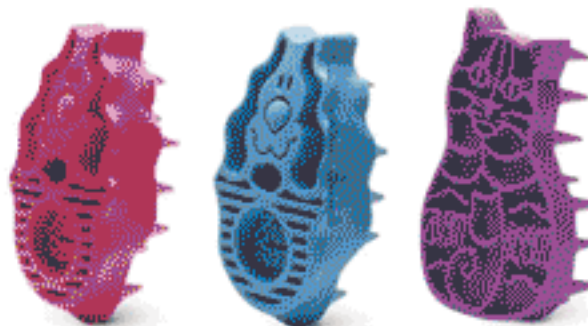

Wooden Bone-Shaped Leash Holder

A beautiful, yet functional addition to any décor. The Wooden Bone Shaped Leash Holder is carved from the finest wood to add a touch of class to any room. Four mounted pegs provide ample room for hanging leashes and collars. The cut-out in the middle is sized to proudly display a photo of your canine companion.

CP13300 Measures 10 3/4" L x 5 1/2" H. \$6.99/ea



Feral Cat Den

The ACES den is designed to provide a frightened or fractious animal a quiet 'hiding place'. Secure the animal inside by closing the porthole door then remove the den (and animal) from the cage for cleaning, treatment, or transport. Completely eliminates risk of handler injury while providing a stress-free environment for the animal. Dens are 15" x 11" x 10". Fit in any cage larger than 24" X 24".

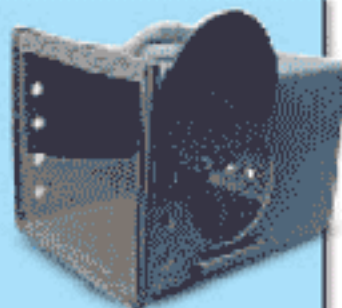

ACE-M-FDGC 15" x 11" x 10" \$120.00/ea



Pet, Grooming & Restraints

Pets - Pet Care

Car Seat Cover

This is a win-win solution for you and your pet! The soft, durable Car Seat Cover will protect your leather or velour seats from pet hair, drool, dust and dirt while traveling. Installs easily - simply set on the seat, attach the Velcro enclosure around the headrest, pull thru the seat belts and tuck in the sides. It is easy in and out making the switch easy for you every time.

Fits most vans, trucks, SUV's with bench or fold-down seats. The outer shell is 100% polyester with a layer of foam for cushion and comfort. One side is a tan, soft pile and reversible to a durable gray polyester weave. Easy to care for, simply hand wash with a mild detergent soap and line dry.



CP512486 Measures 48"x60" \$26.99/ea

Jorvet Comfort Pak Warming Pad

JOR951 \$68.00/ea **JorVet**

Magnetic Pet Pad

Pets enjoy the feeling of warmth that emanates from the energy of the magnets. The convoluted foam used is also great as an orthopedic pad for older pets and those with hip problems.

P1616 16" X 16", 25 magnets \$22.99/ea
 P2432 24" X 32", 42 magnets \$32.50/ea
 P3236 32" X 36", 56 magnets \$37.99/ea



BUSTER Dog Socks

JorVet

The sock is used as a cover for paw-bandages. It is made of rib-knitted cotton with a hard-wearing and waterproof sole so the bandage can "breathe." The sock is pulled tight upwards and fastened with 2 pieces of plain adhesive tape. Available in three sizes

JOR113B Medium \$12.00/ea
 JOR113C Large \$12.00/ea
 JOR113A Small \$12.00/ea



Country Dreams Bed

The combination of an attractive finished wood frame, a reversible fleece/denim bed cover and an elevated bed frame makes this pet bed a welcome addition to your home. These beds are designed with pet and owner in mind. Pets love the comfortable bed because it is soft and cozy. The elevated bed provides comfort and support while sleeping on the soft fleece cushion. Pet owners love the neutral wood finish as it fits with almost any home décor, the detachable cushion is easy to remove for washing and the bed sets up in a few quick and easy steps. This is a welcome addition to any home and certain to make a pet happy for many years to come.



CP42115 Small, 21" x 15" \$39.99/ea
 CP428220 Medium, 28" x 22" \$59.99/ea
 CP43925 Large, 39" x 25" \$72.99/ea



Fleece Bed

This Bed is the perfect solution for bedtime bliss. The padded fleece fabric provides a soft and cuddly slumber mat while the raised edge gives pillow-like support. Made with a durable, 100% polyester fleece shell.

- Quilted style construction keeps padding in place
- Foldable for easy storage & transport
- Machine washable
- Six convenient sizes
- Fits comfortably in most cages

CP13121 31 x 21" \$22.00/ea
 CP11814 18 x 14" \$8.33/ea
 CP12520 25 x 20" \$15.33/ea
 CP13725 37 x 25" \$28.75/ea
 CP14532 45 x 32" \$43.17/ea
 CP15133 51 x 33" \$50.17/ea



Jorvet Canine Icer

The use of cold or ice packs over recent surgical sites, or also for chronic joint pain is well accepted modality. Getting a consistent and even application on a canine patient is the challenge. Canine Icers™ are made of strong and insulating neoprene with soft interior pockets of lycra. Quick release straps allow for maximum adjustability.

JOR342A Stifle-Small \$65.00/ea
 JOR342B Stifle-Medium \$65.00/ea
 JOR342C Stifle-X-Large \$65.00/ea
 JOR342D Stifle-Large \$65.00/ea



Pets - Pet Care



Jorvet Disposable Food Tray Bowls

Disposable Food Tray Bowls are coated paper, which limits cost to just pennies each. They nest together and require little storage space. 1000/case

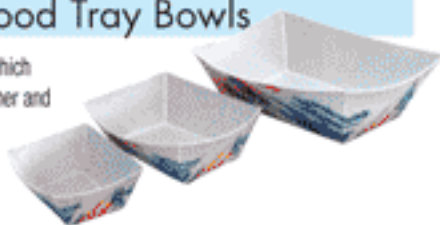

| | | | |
|---------|-------------------|----------------|------------|
| JOR974A | 5" X 4" X 1 1/2" | 8 oz Capacity | \$31.99/cs |
| JOR974C | 10" X 7" X 2 1/2" | 5lb. Capacity | \$97.50/cs |
| JOR974B | 6" X 5" X 1 3/4" | 2 lb. Capacity | \$52.05/cs |

JorVet

Disposable Water and Food Bowls

constructed of a special high-density recyclable foam that is sturdy and completely waterproof. Perfect for either holding liquids or solid food. Hard to tip over.



| | | |
|---------|---------------------------|-------------|
| JOR975A | 8oz. Capacity, 1000/case | \$94.00/cs |
| JOR975B | 16oz. Capacity, 1000/case | \$105.00/cs |

JorVet

Jorvet K-9 Float Coat

JorVet

There is increasing popularity of water treadmills or just the use of swimming as an integral part of canine rehabilitation. A necessary safety precaution should be the use of a quality life preserver. Most of the standard retail preservers just cannot do the job like the Float Coat. The Float Coat has a durable nylon shell with an ergonomic fit. The coat is highly buoyant with a low profile assistance handle. This handle can lift the patient safely from the water. Canine patients will enjoy a safe aquatic adventure free from a scary struggle with K-9 Float Coat quick release buckles. Color: Yellow and Black

- Girth: measurement around the widest part of the rib cage Length: suggested minimum dog length from the back of the neck to the base of the tail.

| | | |
|---------|---|-------------|
| JOR978A | Size XX Small, Dog Girth 12" - 19", Dog Length 9" | \$58.00/ea |
| JOR978B | Size X Small, Dog Girth 17" - 24", Dog Length 12" | \$58.00/ea |
| JOR978C | Size Small, Dog Girth 23" - 30", Dog Length 16" | \$58.00/ea |
| JOR978D | Size Medium, Dog Girth 27" - 32", Dog Length 21" | \$58.00/ea |
| JOR978E | Size Large, Dog Girth 31" - 40", Dog Length 25" | \$58.00/ea |
| JOR978F | Size X Large, Dog Girth 35" - 48", Dog Length 26" | \$58.00/ea |
| JOR978S | Set of 6 sizes | \$320.00/ea |



Stainless Steel Embossed Treat Canister

The perfect place to store treats for your pampered pets. These stylish stainless steel canisters are embossed with paw prints and have a bone shaped handle on the lid. Keeps treats fresh and looks good to you and your pet. With four sizes to choose from, you are sure to find one to fit your needs.



| | | |
|---------|---------------------------------------|-----------|
| CPWTC-3 | Medium, 4 3/4" diameter x 5 1/4" high | \$8.68/ea |
| CPWTC-4 | Large, 5 1/2" diameter x 5 3/4" high | \$9.99/ea |
| CPWTC-1 | Mini, 4 1/4" diameter x 4 1/2" high | \$5.75/ea |
| CPWTC-2 | Small, 4 1/2" diameter x 4 3/4" high | \$6.88/ea |

Shop 24 hours a day 7 days a week
From the comfort of your own home
WWW.SHOPMEDVET.COM

Wee-Wee Pads

Housebreaking the easy way. The super absorbent Wee-Wee Pad will attract puppies when nature calls. The plastic lining prevents damage to floors and carpets. These disposable pads come in many sizes and quantities.

| | | |
|-----------|---|------------|
| AP-F01612 | For Little Dogs, 16.5" x 23.5", 12 pack | \$5.86/pk |
| AP-F01628 | For Little Dogs, 16.5" x 23.5", 28 pack | \$11.70/pk |
| AP-F16000 | 23" x 24", 7 pack | \$3.52/pk |
| AP-F01614 | 22" x 23", 14 pack | \$6.22/pk |
| AP-F01630 | 22" x 23", 30 pack | \$12.34/pk |
| AP-F01635 | 22" x 23", 50 pack | \$19.80/pk |
| AP-F01640 | 22" x 23", 100 count bulk pack | \$33.84/pk |
| AP-F01648 | X-large pads, 28" x 35.5", 21 pack | \$19.44/pk |
| AP-F01646 | X-large pads, 28" x 35.5", 6 pack | \$5.50/pk |
| AP-F01647 | X-large pads, 28" x 35.5", 14 pack | \$13.32/pk |



Pet, Grooming & Restraints

Pets - Urns & Memorials

"Urnee" Cremation Urn **JorVet**

Many cremation urns presently used are very expensive human urns or inappropriate items such as coffee tins. The "Urnee" will satisfy the aesthetic requirements but at a cost low enough for routine use in returning crematory ashes.

- Attractive shape and color decorated with a raised relief rose centered on top
- Insert area for a memorable photo with snap-in cover
- Virtually unbreakable. Made from a heavy injection molded resin
- Inexpensive-costs about 1/4 of other urns
- Complete with a poly bag and tie for secure containment

| | | |
|-----------|---------------------------|------------|
| JOR310SQ | Black, Animals <15 lbs. | \$7.80/ea |
| JOR310SQT | Tan, Animals <15 lbs. | \$7.80/ea |
| JOR310LO | Black, Large, 15-100 lbs. | \$11.11/ea |
| JOR310LOT | Tan, Large, 15-100 lbs. | \$11.25/ea |



Jor310LQ-SQ Series

Antique Bronze Heart Urn

JOR319G 2.9" x 2.7", 5 cu. in. \$39.00/ea

Calico Heart Urn

JOR319H 2.9" x 2.7", 5 cu. in. \$39.00/ea

Natural patina heart Urns

JOR319K 2.9" x 2.7", 5 cu. in. \$33.00/ea



JorVet

Cremation Urn **JorVet**

An increasing number of clients would like the option to keep the ashes from a pet's cremation. These beautifully done ceramic urns allow the veterinarian to return the ashes in a professional and tasteful manner. Black

| | | |
|---------|--|------------|
| JOR310L | Large. (~maximum weight of animal is 130 lbs.) Urn weighs 2 lbs. | \$31.50/ea |
| JOR310S | Small. (~maximum weight of animal is 40 lbs.) Urn weighs 1 lb. | \$28.50/ea |



Pet Burial Boxes **JorVet**

This is the professional and respectful way to return deceased pets to their owners. No more need to use old drug boxes. It is suggested to use a JOR108 cadaver bag, then place the animal in the burial box. Available in 3 sizes.

| | | |
|---------|---|------------|
| JOR308A | Small, 12-pack | \$85.50/dz |
| JOR308B | Medium, 10-pack | \$94.00/pk |
| JOR308C | Large, 5-pack | \$69.00/pk |
| JOR308 | intro pack (3 Small, 2 Medium, 1 Large) | \$65.50/pk |

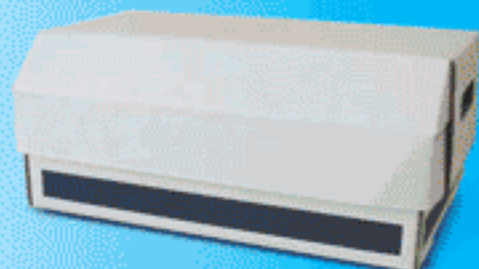

Pet Keepsake Memorials

Cherish the memories of your pet long after they've gone with this thoughtfully designed and crafted memorial. It is available in a number of sizes in honey maple or mahogany finish. You can choose a folding design or rotating pedestal. Each keepsake memorial folding design holds two of your cherished photos and has a secure compartment perfect for favorite toys, collars, or ashes. The rotating pedestal design holds four photos and has a secure compartment.

| | | |
|---------|--------------------------------------|------------|
| CP99658 | medium rotating in honey maple, 5x8" | \$26.50/ea |
| CP99668 | medium folding in honey maple, 6x8" | \$23.50/ea |
| CP99669 | large rotating in honey maple, 6x9" | \$30.99/ea |
| CP99758 | medium rotating in mahogany, 5x8" | \$26.50/ea |
| CP99768 | medium folding in mahogany, 6x8" | \$23.50/ea |
| CP99769 | large rotating in mahogany, 6x9" | \$30.99/ea |



CP99758

13822 WEST BOULTON BLVD. METTAWA, IL 60045

WWW.SHOPMEDVET.COM

Phone 800-544-7521

168

Fax 800-204-2177

Pet, Grooming & Restraints



Pets - Urns

Terry Bear Urns **JorVet**

Introducing an expanded range of designer style pet urns to offer veterinarian clients a wider range of choices for cremation urns. All urns have a threaded screw on lid for security.

Classic Bronze

| | | |
|---------|---|------------|
| JOR316A | Classic Bronze Urn, 5.7" x 3.9", 40 sq. in. capacity, Pet Weight up to 35 lbs., Small | \$36.00/ea |
| JOR316B | Classic Bronze Urn, 7.0" x 5.0", 85 sq.in. capacity, Pet Weight 35-65 lbs., Medium | \$48.00/ea |
| JOR316C | Classic Bronze Urn, 7.8" x 5.7", 125 sq.in. capacity, 55-100 lbs., Large | \$66.00/ea |

Classic Pewter

| | | |
|---------|---|------------|
| JOR316D | Classic Pewter Urn, 5.7" x 3.9", 40 sq. in., up to 35 lbs., Small | \$36.00/ea |
| JOR316E | Classic Pewter Urn, 7.0" x 5.0", 85 sq. in., 35-65 lbs., Medium | \$45.00/ea |
| JOR316F | Classic Pewter Urn, 7.8" x 5.7", 125sq. in. 55-100 lbs., Large | \$66.00/ea |

Dove Inlays

| | | |
|---------|--|------------|
| JOR316G | Going Home Urn-Contains Dove Inlays, 5.7" x 3.9", 40 sq. in., up to 35 lbs., Small | \$34.50/ea |
| JOR316H | Going Home Urn-Contains Dove Inlays, 7.0" x 5.0", 85 sq. in., 35-65 lbs., Medium | \$51.00/ea |
| JOR316J | Going Home Urn-Contains Dove Inlays, 7.8" x 5.7", 125 sq. in., 55-100 lbs., Large | \$66.00/ea |

Silver Engraved

| | | |
|---------|--|------------|
| JOR316K | Silver Engraved Urn, 6.1" x 3.9", 25 sq. in., up to 15 lbs., X Small | \$36.00/ea |
| JOR316L | Silver Engraved Urn, 6.5" x 4.7", 40 sq. in., 10 to 35 lbs., Small | \$39.00/ea |
| JOR316M | Silver Engraved Urn, 7.5" x 5.6", 70 sq. in., 30-60 lbs., Medium | \$54.00/ea |

Avalon Evening Blue

| | | |
|---------|---|------------|
| JOR316N | Avalon Evening Blue Urn, 5.8" x 4.3", 55 sq. in., up to 35lbs., Small | \$49.50/ea |
| JOR316P | Avalon Evening Blue Urn 7.4" x 5.2", 90sq. in., 35-65 lbs., Medium | \$63.00/ea |
| JOR316Q | Avalon Evening Blue Urn, 8.4" x 5.8", 130 sq. in., 55-100 lbs. Large | \$78.00/ea |

Avalon Mahogany

| | | |
|---------|---|------------|
| JOR316R | Avalon Mahogany Urn, 8.4" x 5.8", 130 sq. in., 55-100 lbs. Large | \$49.50/ea |
| JOR316S | Avalon Mahogany Urn, 7.4" x 5.2", 90 sq. in., 35-65 lbs., Medium | \$69.00/ea |
| JOR316T | Avalon Mahogany Urn, 8.4" x 5.8", 130 sq. in., 55-100 lbs., Large | \$78.00/ea |

Pewter/Brass Double Paw

| | | |
|-----------|---|------------|
| JOR316DPH | Pewter/Brass Double Paw Heart Urn, 2.9" x 2.9" x 2.7", 5 cu.in. | \$39.00/ea |
| JOR316DPL | Pewter/Brass Double Paw Odyssey, 5.8" x 5.8" x 4.5", 70c.i. | \$49.00/ea |
| JOR316DPM | Pewter/Brass Double Paw Odyssey, 4.9" x 4.9" x 3.5", 40c.i. | \$48.00/ea |
| JOR316DPS | Pewter/Brass Double Paw Odyssey, 4.3" x 4.3" x 3.3", 25c.i. | \$30.00/ea |

Slate/Pewter Single Paw

| | | |
|-----------|---|------------|
| JOR316SPL | Slate/Pewter Single Paw Odyssey, 5.8" x 5.8" x 4.5", 70c.i. | \$46.00/ea |
| JOR316SPM | Slate/Pewter Single Paw Odyssey, 4.9" x 4.9" x 3.5", 40c.i. | \$38.00/ea |
| JOR316SPS | Slate/Pewter Single Paw Odyssey, 4.3" x 4.3" x 3.3", 25c.i. | \$30.00/ea |

Crouching Cat

| | | |
|---------|--|------------|
| JOR317A | Crouching Cat Urn - Calico, 9.7" x 3.9", 35 sq. in., up to 30 lbs. | \$72.00/ea |
| JOR317B | Crouching Cat Urn - Patina, 9.2" x 4.6", 40 sq. in., up to 35 lbs. | \$72.00/ea |

Sitting Cat

| | | |
|---------|---|------------|
| JOR317C | Sitting Cat Urn - Dark Bronze, 9.2" x 4.6", 40 sq. in., up to 35 lbs. | \$69.00/ea |
| JOR317D | Sitting Cat Urn - Calico, 9.7" x 3.9", 35 sq. in., up to 30 lbs. | \$69.00/ea |





Pewter/Slate Paw Urns **JorVet**

Introducing an expanded range of designer style pet urns to offer veterinarian clients a wider range of choices for cremation urns. All urns have a threaded screw on lid for security.

Pewter

JOR316DPH Pewter/Brass Double Paw Heart Urn, 2.9" x 2.9" x 2.7", 5 cu.in. \$39.00/ea

Slate

JOR316SPH Slate/Pewter Single Paw Heart 2.9 x 2.9 x 2.7 5c.i. \$37.50/ea

Photo Box Urn **JorVet**

Introducing an expanded range of designer style pet urns to offer veterinarian clients a wider range of choices for cremation urns. All urns have a threaded screw on lid for security.

Birch

JOR316PBS Birch Finish MDF, Small \$30.50/ea

JOR316PEM Birch Finish MDF, Medium \$37.50/ea

JOR316PEL Birch Finish MDF, Large \$44.00/ea

Cherry

JOR316PCS Cherry Finish MDF, Small \$38.00/ea

JOR316PCM Cherry Finish MDF, Medium \$33.50/ea

JOR316PCL Cherry Finish MDF, Large \$38.00/ea

Black

JOR316PFS Black Finish MDF, Small \$38.00/ea

JOR316PFM Black Finish MDF, Medium \$37.50/ea

JOR316PFL Black Finish MDF, Large \$38.00/ea



Cotton & Gauze Products



Gauze Sponges

Non-Woven Gauze Sponges

Compare to NU-GAUZE or Versalon and SAVE! Same properties and packaging as NU-GAUZE and Versalon for LESS! Order Today!

| | | |
|-------|-----------------------|-----------|
| PK224 | 2" X 2" 4-Ply 200/Pkg | \$1.50/pk |
| PK334 | 3" X 3" 4-Ply 200/Pkg | \$3.25/pk |
| PK444 | 4" X 4" 4-Ply 200/Pkg | \$4.25/pk |



By The Case

| | | |
|-------|-----------------------|------------|
| 224CS | 2" X 2" 4-Ply 8000/cs | \$49.00/cs |
| 334CS | 3" X 3" 4-Ply 4000/cs | \$59.00/cs |
| 444CS | 4" X 4" 4-Ply 2000/cs | \$39.00/cs |



Gauze Sponges

High quality, non-sterile gauze made of lint free cotton with no raw edges or loose threads. High absorbency, low linting, and costs less than the leading brands. Compare to any leading brand of sponge.



| | | |
|-------|------------------------|-----------|
| PK208 | 2" X 2" 8-Ply 200/Pkg | \$2.29/pk |
| PK212 | 2" X 2" 12-Ply 200/Pkg | \$2.59/pk |
| PK308 | 3" X 3" 8-Ply 200/Pkg | \$3.59/pk |
| PK312 | 3" X 3" 12-Ply 200/Pkg | \$4.50/pk |
| PK408 | 4" X 4" 8-Ply 200/Pkg | \$4.50/pk |
| PK412 | 4" X 4" 12-Ply 200/Pkg | \$7.95/pk |
| PK416 | 4" X 4" 16-Ply 200/Pkg | \$9.95/pk |

By The Case

| | | |
|------|------------------------|------------|
| 208C | 2" X 2" 8-Ply 5000/cs | \$46.00/cs |
| 212C | 2" X 2" 12-Ply 8000/cs | \$89.60/cs |
| 308C | 3" X 3" 8-Ply 4000/cs | \$65.80/cs |
| 312C | 3" X 3" 12-Ply 4000/cs | \$79.00/cs |
| 408C | 4" X 4" 8-Ply 4000/cs | \$84.00/cs |
| 412C | 4" X 4" 12-Ply 2000/cs | \$69.50/cs |



Jorvet Non-Woven Sponge Gauze

Synthetic rayon and polyester non-woven fabric. These sponges are lint free, superior in strength and 50 percent more absorbable than cotton sponges.

| | | |
|---------|------------------------------------|-------------|
| JOR570A | 2" x 2", 4-ply, 200/pk, 40 pk/case | \$102.00/cs |
| JOR570B | 3" x 3", 4-ply, 200/pk, 20 pk/case | \$72.00/cs |
| JOR570C | 4" x 4", 4-ply, 200/pk, 20 pk/case | \$101.00/cs |



Sterile Gauze

Made from the finest USP Type VII gauze. Packed in Sterile 2's.

| | | |
|------------|-------------------------|------------------------|
| 208STRL | 2" X 2" 8Ply 2'S 50Pk | \$2.99/pk |
| 208STRL-CS | 2" X 2" 8Py 2'S 3000/cs | \$49.99/cs |
| 212STRL | 2" X 2" 12Ply 2'S 50Pk | \$3.25/pk |
| 312STRL | 3" X 3" 12Ply 2'S 25Pk | \$2.99/pk 10+\$1.99/ea |
| 408STRL | 4" X 4" 8Ply 2'S 25Pk | \$4.99/pk |



Jorvet Fluff Dressing Bandage

A 6-ply 100 percent cotton gauze that is very soft with fluff dried heavy-ply for cushioning and protection.

| | | |
|--------|---------------------------|------------|
| JOR573 | 4 1/2", 12/bag, 4 bags/cs | \$69.00/cs |
|--------|---------------------------|------------|



Jorvet Self Adherent Bandage

2-ply high quality cotton gauze that is excellent for general bandaging.

| | | |
|---------|-------------------------|------------|
| JOR572A | 2", 2/bag, 8 bags/case | \$41.00/cs |
| JOR572B | 3", 12/bag, 8 bags/case | \$50.00/cs |
| JOR572C | 4", 12/bag, 8 bags/case | \$64.00/cs |
| JOR572D | 6", 6/bag, 8 bags/case | \$43.00/cs |

Jorvet Stretch Conforming Gauze Bandage

The unique bandage pattern allows controlled stretch compared to cling gauze. It molds to any body shape to allow freedom of movement. It is also soft and light weight.

| | | |
|---------|--------------------------------|------------|
| JOR571A | 1" x 4.1 yds. 12/pk, 8 pk/case | \$21.00/cs |
| JOR571B | 2" x 4.1 yds. 12/pk, 8 pk/case | \$35.50/cs |
| JOR571C | 3" x 4.1 yds. 12/pk, 8 pk/case | \$44.00/cs |
| JOR571D | 4" x 4.1 yds. 12/pk, 8 pk/case | \$51.00/cs |

13822 WEST BOULTON BLVD. METTAWA, IL 60045

Phone 800-544-7521

171

WWW.SHOPMEDVET.COM

Fax 800-204-2177

Cotton & Gauze Products



Lap Sponge & Gauze Bandage Rolls

Lap Sponge Sterile

Highly Absorbent Lap Sponges are X-Ray Detectable. These latex-free lap sponges are pre washed and de-linted for problem-free use.



| | | |
|-----------|------------------|-------------|
| LAP1212 | 12" X 12" 5/Pk | \$2.00/pk |
| LAP1212CS | 12" X 12" 200/cs | \$79.95/cs |
| LAP1818 | 18" X 18" 5/Pk | \$3.00/pk |
| LAP1818CS | 18" X 18" 200/cs | \$119.95/cs |

Lap Sponge Non-sterile

Highly Absorbent Lap Sponges are X-Ray Detectable. Made up of mostly 18" x 18", 4" x 18" and 8" x 36" sizes, these latex-free lap sponges are pre washed and de-linted for problem-free use.



| | | |
|----------|--------------------|------------|
| LAP-BULK | 200/cs mixed sizes | \$39.00/cs |
|----------|--------------------|------------|

Jorvet Laparotomy Sponges

Pre-washed 8-ply lap sponges, radio-opaque with loops. Useful in retaining body structures during deep abdominal surgery.

| | | |
|----------|------------------------------|-----------|
| JOR490A | 18" x 18", 5 pk, Non-Sterile | \$3.30/pk |
| JOR490AS | 18" x 18", 2 pack, Sterile | \$2.70/pk |
| JOR490B | 4" x 18", 5pk, Non-Sterile | \$2.25/pk |
| JOR490BS | 4" x 18", 2 pack, Sterile | \$4.05/pk |



Sterile Stretch Gauze Rolls

Stretches and conforms to body contours without drooping or falling off. It's high absorbency helps maintain a drier wound site.

| | | |
|---------|-------------------|-----------|
| 492STRL | 2" X 4.1 yds Each | \$0.35/ea |
| 493STRL | 3" X 4 yds Each | \$0.45/ea |
| 494STRL | 4" X 2.1 yds Each | \$0.45/ea |
| 496STRL | 6" X 4 yds Each | \$0.85/ea |



Gauze Bandage Roll

Non-sterile, single ply bandage rolls consisting of 100% mesh gauze. 10 yards in length. 12 per bag.

| | | |
|--------|--------------------|------------|
| 1350-1 | 1" X 10 yds 12/Bag | \$3.99/bg |
| 1350-2 | 2" X 10 yds 12/Bag | \$7.49/bg |
| 1350-3 | 3" X 10 yds 12/Bag | \$11.49/bg |



JorVet Gauze Roll Bandage

This single-ply cotton gauze bandage conforms to a wide range of uses around the clinic besides the normal wound bandaging. Thick 28 x 24 mesh covered in paper. 12 rolls/pk.

Applications:

- Wrapping over primary dressings
- Simple muzzles
- Tying endotracheal tubes during intubation
- Surgical tie downs



| | | |
|---------|-------------------------|------------|
| JOR888 | 1", 10 yds, 12 rolls/pk | \$4.00/dz |
| JOR888A | 2", 10 yds, 12 rolls/pk | \$8.00/dz |
| JOR888B | 3", 10 yds, 12 rolls/pk | \$12.00/dz |
| JOR888C | 4", 10 yds, 12 rolls/pk | \$12.00/dz |

Non-Sterile Stretch Gauze Rolls

Stretches and conforms to body contours without drooping or falling off. It's high absorbency helps maintain a drier wound site.

| | | |
|------|--------------------|-----------|
| 492Z | 2" X 4.1 yds 12/Bg | \$2.75/bg |
| 493Z | 3" X 4.1 yds 12/Bg | \$3.75/bg |
| 494Z | 4" X 4.1 yds 12/Bg | \$4.75/bg |
| 496Z | 6" X 4.1 yds 6/Bg | \$3.75/bg |



By Bulk

| | | |
|---------|------------------------|------------|
| 492BULK | 2" 12/bg 8/bg/cs 96/cs | \$12.95/cs |
| 493BULK | 3" 12/bg 8/bg/cs 96/cs | \$15.95/cs |
| 494BULK | 4" 12/bg 8/bg/cs 96/cs | \$18.95/cs |
| 496BULK | 6" 6/bg 8/bg/cs 48/cs | \$15.95/cs |



Kerlix Type Gauze Rolls

6-ply, 100% cotton. Unique crimped, open-weave design means superior absorbency and cushioning. Gently stretches and conforms to body contours. Used as either a primary or secondary dressing. 4" x 4 yard Kerlix-type rolls. Available in sterile and non-sterile packages.

| | | | |
|-------------|------------------------|-----------|---------------|
| BULKEE-NS | 4" X 4 yds Non-Sterile | \$0.79/ea | 100+/\$0.69ea |
| BULKEE-STRL | 4" X 4 yds Non-Sterile | \$0.95/ea | 100+/\$0.85ea |

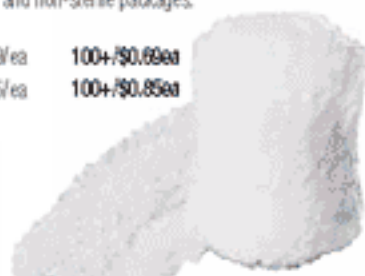

13822 WEST BOULTON BLVD. METTAWA, IL 60045

Phone 800-544-7521

172

WWW.SHOPMEDVET.COM

Fax 800-204-2177

Cotton & Gauze Products

Cotton; Rolls, Balls, Bandaging & Brown Rolls



Cotton Roll



The versatility of roll cotton is unmatched. This one pound Non-Sterile roll is made from 100% cotton. It can be used for facial, nail, skin care applications, swabs, padding, leg wraps and many other uses. The highest quality cotton rolls available for applications where absorbency, flexibility, cleanliness, and softness are key requirements.

2661 1 Pound \$3.25/roll

2661



Jorvet Cotton Roll



Great for wound care and padding. Bright white, seed-free long stem cotton. Layers in roll separated by blue paper. Outer white poly bag.

JOR197 30 rolls/case \$4.95/ea

#JOR197



Cotton Roll

This one pound Sterile roll is made from 100% cotton. It can be used for facial, nail, skin care applications, swabs, padding, leg wraps and many other uses. The highest quality cotton rolls available for applications where sterility, absorbency, flexibility, cleanliness, and softness are key requirements.

8401W 1 pound sterile \$8.99/roll



Jorvet Cotton Bandage Sheeting

Popular "sheet cotton" material constructed of thin sheet spun cotton fibers. Highly absorbent material that offers excellent protection at an affordable price. Packaged in two forms. (not pictured)

JOR871 30" x 36" Rolled and packaged in poly bag. 12 sheets/bag, 20 bags. \$111.00/ea

JOR871B 30" x 28" Bulk in large flat bale. 240/bale. \$111.00/ea

Non-Sterile Cotton Balls

COTBALL Medium, 4000/cs \$15.59/cs
COTBALL-LG Large, 2000/cs \$14.95/cs

as low as

\$14.95/cs
Medium



Jorvet Absorbent Cotton Balls

Medium fluffy quality cotton.

JOR850 2000/bag \$7.50



Brown Gauze Rolls

Heavy type brown gauze roll 5 yards in length. 12 per leg

BG3 3" X 5 yds 12/Bg \$5.99/bg
BG6 6" X 5 yds 12/Bg \$9.99/bg

By The Case

BG3CS 3", 96/case \$39.00/cs
BG6CS 6", 96/case \$69.00/cs



Jorvet Brown "Cling" Gauze

Our brown "cling" gauze is 100 percent pure cotton and comes in fine 24 x 17 mesh.

JOR192A 3" x 5 yds., dozen/pk. \$6.30/dz

JOR192B 6" x 5 yds., dozen/pk. \$10.35/dz



Xeroform Petroleum Gauze

Petroleum gauze with xeroform, a medicating and deodorizing agent with 3 percent Bismuth Tribromophenate. Occlusive, non-adherent dressing contraindicated for draining wounds. Sterile, Latex-free

NON253180Z 1" X 8", 12/box \$8.99/box

NON253220Z 2" x 2", 12/box \$9.99/box

NON253440 4" x 4", 144/cs \$107.00/cs



FREE

US SAVINGS BOND

with required purchase, certain restrictions apply.
See Inside Cover for Details



13822 WEST BOULTON BLVD. METTAWA, IL 60045

WWW.SHOPMEDVET.COM

Phone 800-544-7521

173

Fax 800-204-2177

Gloves

Exam & Latex

Micro-touch® Latex Exam Gloves

Latex Powdered Examination gloves have an anti-slip, smooth finish. Powdered with absorbable dusting powder. Straight, reinforced cuff made with natural rubber latex. Microtouch® is a registered trademark of Ansell.



| | | | |
|------|----------------|-----------|--------------|
| 5721 | Small, 100/bx | \$7.99/bx | 10+\$7.49/bx |
| 5741 | Medium, 100/bx | \$7.99/bx | 10+\$7.49/bx |
| 5761 | Large, 100/bx | \$7.99/bx | 10+\$7.49/bx |

Micro-Touch® Nextstep Powder-Free Exam Gloves

Glove is powder-free to help eliminate powder-related complications and sensitivity. Excellent tactile sensitivity, fit, and feel. Micro-Touch® is a registered trademark of Ansell.



- Textured to enhance grip
- Ambidextrous.

| | | | |
|------|-----------------|-----------|--------------|
| 3201 | Small, 100/bx | \$8.99/bx | 10+\$8.29/bx |
| 3202 | Medium, 100/bx | \$8.99/bx | 10+\$8.29/bx |
| 3203 | Large, 100/bx | \$8.99/bx | 10+\$8.29/bx |
| 3204 | X-Large, 100/bx | \$8.99/bx | 10+\$8.29/bx |

\$8.99/bx

Vinyl Gloves

These top-quality, non-sterile gloves are at a price that can't be beat by anyone! 100/bx. Various manufacturers.

| | | |
|----------|----------------|-----------|
| VINYL-S | Small 100/bx | \$3.99/bx |
| VINYL-M | Medium 100/bx | \$3.99/bx |
| VINYL-L | Large 100/bx | \$3.99/bx |
| VINYL-XL | X-Large 100/bx | \$3.99/bx |



\$3.99/bx

Micro-Touch® Smooth Nitrile Exam Gloves

Latex-Free, Powder-Free Exam gloves help eliminate powder-related complications and sensitivity. 100% Nitrile, does not contain natural rubber latex. Excellent chemical resistance. Color is blue. Micro-Touch® is a registered trademark of Ansell.



latexfree
PRODUCT

| | | | |
|---------|-----------------|------------|--------------|
| 6034101 | Small, 100/bx | \$10.49/bx | 10+\$9.49/bx |
| 6034102 | Medium, 100/bx | \$10.49/bx | 10+\$9.49/bx |
| 6034103 | Large, 100/bx | \$10.49/bx | 10+\$9.49/bx |
| 6034104 | X-Large, 100/bx | \$10.49/bx | 10+\$9.49/bx |

As low as

10+\$9.49/bx

Powdered Latex Gloves

Non-Sterile, lightly-powdered. Top-quality 100 ambidextrous gloves per box. Various manufacturers.

| | | |
|------|-----------------|-----------|
| AHXS | X-Small, 100/bx | \$4.99/bx |
| AHSS | Small 100/bx | \$4.99/bx |
| AHSM | Medium 100/bx | \$4.99/bx |
| AHSL | Large 100/bx | \$4.99/bx |
| AHXL | X-Large 100/bx | \$4.99/bx |

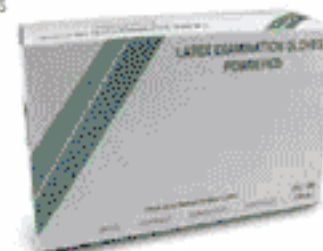

Powder-Free Latex Gloves

Non-Sterile, powder-free. Top-quality 100 ambidextrous gloves per box. Various manufacturers.

| | | |
|---------|----------------|-----------|
| AHSPFS | Small 100/bx | \$6.99/bx |
| AHSPFM | Medium 100/bx | \$6.99/bx |
| AHSPFL | Large 100/bx | \$6.99/bx |
| AHSPFXL | X-Large 100/bx | \$6.99/bx |



Jorvet Sterile OB Sleeve

Disposable plastic shoulder length OB sleeves, packed in an easy open chevron pouch. Amber. Two sleeves per pouch. 5 pouches/pkg.

| | | |
|---------|--------|-------------|
| JOR100S | 10/pkg | \$11.10/pkg |
|---------|--------|-------------|



Nitrile Gloves

Non-sterile, top-quality latex-free exam gloves. 100 ambidextrous gloves per box. No choice of color. No choice of powdered or powder-free. Various manufacturers.

| | | |
|------------|------------------------|-----------|
| NITRILE-XS | Nitrile X-Small 100/bx | \$6.99/bx |
| NITRILE-S | Nitrile Small 100/bx | \$6.99/bx |
| NITRILE-M | Nitrile Medium 100/bx | \$6.99/bx |
| NITRILE-L | Nitrile Large 100/bx | \$6.99/bx |
| NITRILE-XL | Nitrile X-Large 100/bx | \$6.99/bx |



latexfree
PRODUCT

Pink Gloves

3G PF Stretch Synthetic Vinyl Exam: These soft, comfortable third generation stretch synthetic vinyl gloves are 100% latex-free and DEHP free. The narrow cuff reduces roll down.

| | | |
|----------|----------------------|-----------|
| PINK6076 | Large, 100/bx Pink | \$6.99/bx |
| PINK6074 | Small, 100/bx Pink | \$6.99/bx |
| PINK6075 | Medium, 100/bx Pink | \$6.99/bx |
| PINK6077 | X-Large, 100/bx Pink | \$6.99/bx |



**NEW
AVAILABLE**

A portion of the proceeds from the PINK GLOVES sales will be donated to National Breast Cancer Foundation to fund free mammograms for underserved women.

13822 WEST BOULTON BLVD. METTAWA, IL 60045

WWW.SHOPMEDVET.COM

Phone 800-544-7521

174

Fax 800-204-2177

Gloves

Nitrile & Surgical

Powder Free Surgeon Glove

Sterile, powder-free. Top-quality 50 pair per box.
Various manufacturers.

| | | | |
|----------|-----|-----------|-------------|
| SG5.5-PF | 5.5 | 40 pr/box | \$27.95/box |
| SG6-PF | 6 | 40 pr/box | \$27.95/box |
| SG6.5-PF | 6.5 | 40 pr/box | \$27.95/box |
| SG7-PF | 7 | 40 pr/box | \$27.95/box |
| SG8-PF | 8 | 40 pr/box | \$27.95/box |
| SG8.5-PF | 8.5 | 40 pr/box | \$27.95/box |
| SG9-PF | 9 | 40 pr/box | \$27.95/box |



Powdered Surgeon Glove

Sterile, powdered. Top-quality 50 pair per box. Various manufacturers.

| | | | |
|-------|------|-----------|-------------|
| SG5.5 | 5.5, | 40 pr/box | \$21.95/box |
| SG6 | 6, | 40 pr/box | \$21.95/box |
| SG6.5 | 6.5, | 40 pr/box | \$21.95/box |
| SG7 | 7, | 40 pr/box | \$21.95/box |
| SG7.5 | 7.5, | 40 pr/box | \$21.95/box |
| SG8 | 8, | 40 pr/box | \$21.95/box |
| SG8.5 | 8.5, | 40 pr/box | \$21.95/box |
| SG9 | 9, | 40 pr/box | \$21.95/box |



Aloetouch® Exam Gloves



Aloetouch® are top-quality powder-free gloves with the benefits of aloe vera. Aloe vera naturally helps moisturize and soothe dry, chapped hands. These strong, durable, natural rubber latex gloves provide superior barrier protection and are powder-free to minimize skin irritation. The fully textured surface gives you a sure grip on instruments and dressings. Ideal for anyone who changes gloves frequently, washes hands repeatedly, or wears gloves for extended periods of time. Aloetouch® is a registered trademark of Medline.

| | | |
|---------|-----------------|------------|
| ALOE-S | Small 100/box | \$8.99/box |
| ALOE-M | Medium 100/box | \$8.99/box |
| ALOE-L | Large 100/box | \$8.99/box |
| ALOE-XL | X-Large 100/box | \$8.99/box |



\$8.99/box

Sensi-Touch® Surgical Gloves

Sensi-Touch® powdered surgical gloves are 12 inches in length with a straight, reinforced cuff for extra coverage and protection on the forearm. Sensi-Touch® is a registered trademark of Ansell.

- Natural Rubber Latex
- Anti-Slip Smooth finish
- Sterile.



| | | | | |
|------|----------|-----------|-------------|---------------|
| 7821 | Size 5.5 | 50 pr/box | \$26.49/box | 4+\$24.49/box |
| 7822 | Size 6 | 50 pr/box | \$26.49/box | 4+\$24.49/box |
| 7823 | Size 6.5 | 50 pr/box | \$26.49/box | 4+\$24.49/box |
| 7824 | Size 7 | 50 pr/box | \$26.49/box | 4+\$24.49/box |
| 7825 | Size 7.5 | 50 pr/box | \$26.49/box | 4+\$24.49/box |
| 7826 | Size 8 | 50 pr/box | \$26.49/box | 4+\$24.49/box |
| 7827 | Size 8.5 | 50 pr/box | \$26.49/box | 4+\$24.49/box |
| 7828 | Size 9 | 50 pr/box | \$26.49/box | 4+\$24.49/box |

Ansell

As low as
\$26.49/box

Micro-Touch® Surgeon Gloves

These sterile, latex, surgeons gloves feature a natural contour design and longer beaded cuffs for added protection. Fingers are curved and tapered to provide greater comfort. Gloves come with 50 pairs box.



| | | | | |
|--------|----------|-----------|-------------|---------------|
| JJ5860 | Size 6 | 50 pr/box | \$39.95/box | 4+\$36.95/box |
| JJ5865 | Size 6.5 | 50 pr/box | \$39.95/box | 4+\$36.95/box |
| JJ5870 | Size 7 | 50 pr/box | \$39.95/box | 4+\$36.95/box |
| JJ5875 | Size 7.5 | 50 pr/box | \$39.95/box | 4+\$36.95/box |
| JJ5880 | Size 8 | 50 pr/box | \$39.95/box | 4+\$36.95/box |
| JJ5885 | Size 8.5 | 50 pr/box | \$39.95/box | 4+\$36.95/box |
| JJ5890 | Size 9 | 50 pr/box | \$39.95/box | 4+\$36.95/box |

Perry Original Surgeon Gloves

Perry Style 42 powdered surgical gloves provide uncompromising quality and durability. Natural Rubber latex, anti-slip and smooth finish Sterile



| | | | | |
|---------|----------|-----------|-------------|---------------|
| 5711100 | Size 5.5 | 50 pr/box | \$28.49/box | 4+\$25.49/box |
| 5711101 | Size 6 | 50 pr/box | \$28.49/box | 4+\$25.49/box |
| 5711102 | Size 6.5 | 50 pr/box | \$28.49/box | 4+\$25.49/box |
| 5711103 | Size 7 | 50 pr/box | \$28.49/box | 4+\$25.49/box |
| 5711104 | Size 7.5 | 50 pr/box | \$28.49/box | 4+\$25.49/box |
| 5711105 | Size 8 | 50 pr/box | \$28.49/box | 4+\$25.49/box |
| 5711106 | Size 8.5 | 50 pr/box | \$28.49/box | 4+\$25.49/box |
| 5711107 | Size 9 | 50 pr/box | \$28.49/box | 4+\$25.49/box |

13822 WEST BOULTON BLVD. METTAWA, IL 60045

Phone 800-544-7521

175

WWW.SHOPMEDVET.COM

Fax 800-204-2177

Gloves

Surgical & Glove Dispensers



Neolon Surgical Glove

Neolon 2G PF Neoprene Surgical Gloves: New proprietary neoprene formulation, which is softer, more elastic and comfortable vs. traditional neoprene gloves. The lightly textured grip provides more sensitivity. Reinforced cuff reduces cuff tearing during donning and in use. ARC (anti-roll down cuff) was designed to reduce cuff roll down common with most powder-free gloves. The inner polymer coating allows easy donning both with damp and dry hands. Brown/tan color reduces the glare from the lights in the O.R. 100/case

| | | |
|------------|----------|-------------|
| MD S207060 | Size 6.0 | \$201.55/cs |
| MD S207065 | Size 6.5 | \$201.55/cs |
| MD S207070 | Size 7.0 | \$201.55/cs |
| MD S207075 | Size 7.5 | \$201.55/cs |
| MD S207080 | Size 8.0 | \$201.55/cs |
| MD S207085 | Size 8.5 | \$201.55/cs |
| MD S207090 | Size 9.0 | \$201.55/cs |



Elbow Glove

Top Quality. 100 per box. One size fits all.
AHSELG .03X240X530mm 100/Box \$8.00/box



Shoulder Length Gloves

Top Quality. 100 per box. One size fits all.
AHSSLG .03 X 240 X 830mm 100/BOX

\$11.00/ea



Danish Disposable Gloves

"Krutex" Disposable Gloves, OB sleeve these gloves were developed for small hands for a tighter fit. Amber.

| | | |
|----------|----------------|-------------|
| JOR100D | 100/box, Amber | \$19.50/box |
| JOR100DS | 100/box, Amber | \$30.00/box |



Vet-R-Sem Gloves

This very popular glove fits your hand with no overlapping finger ends. Seams are very low and stretch well. The veterinarian's choice for sensitivity and strength. 1.35mil. Extra long: 35". Clear. 100/zip lock bag.

| | | |
|--------|------------------|-------------|
| JOR100 | 100/zip lock bag | \$20.25/bag |
|--------|------------------|-------------|



Acrylic Exam Glove Dispenser

Every exam room needs these wall-mounted glove dispensers. They free up counter space and give a clean, professional image. The dispenser fits virtually all brands of latex gloves. Includes all mounting hardware.

| | | |
|---------|------------------------|------------|
| JOR876Q | Single box, Horizontal | \$46.00/ea |
| JOR876R | Single box, Vertical | \$46.00/ea |
| JOR876S | Double box, Horizontal | \$49.00/ea |
| JOR876K | Triple box, Horizontal | \$60.00/ea |



Exam Glove Box Holder

Wall mount your exam gloves out of the way, but still have easy access. Attractive epoxy coated steel wire racks will hold one single box of all major brands of exam gloves. Complete with mounting screws.

Jorvet

| | | |
|---------|-------------------------------------|------------|
| JOR876 | Holds 1 Box, 102mm x 140mm x 208mm | \$22.50/ea |
| JOR876A | Holds 3 Boxes, 250mm x 96mm x 432mm | \$41.40/ea |



Glove Dispenser

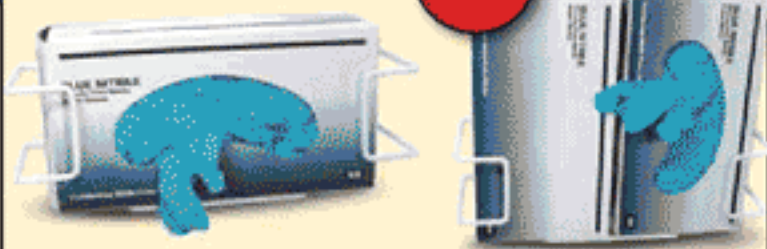

Available in vinyl-coated steel, this sturdy dispenser holds one box of gloves horizontally or two boxes vertically. See-through construction allows easy identification of glove sizes. 10 3/8"W x 4"H x 3 1/2"D.

| | | |
|-------------|-----------|-------------|
| GLOVEHOLDER | \$9.95/ea | 3+\$8.95/ea |
|-------------|-----------|-------------|

SURGICAL APPAREL

- GOWNS: BARRIER, SURGEONS, DISPOSABLE, POLYETHYLENE
- SHOE COVERS
- GOGGLES/GLASSES

CHECKOUT SURGICAL AND EXAM SECTION IN THIS CATALOG



Gloves

Animal Handling



Warden Pro Handling Gloves

Developed to prevent the intrusion of sharp objects while handling dogs, cats, snakes, or small wild animals. Allows maximum dexterity. This glove is not bite-proof.

WARDENPRO Length: 22 inches, Palomino leather, Dupont Kevlar felt lining. \$126.50/pr



Warden Handling Gloves

Developed for the gentle handling of dogs, cats, snakes, small wild animals. Length: 22 inches, Palomino leather, Dupont Kevlar felt lining. This glove is not bite proof.

WARDEN-M Medium \$99.50/pr
WARDEN-L Ladies \$99.50/pr



Magnum Handling Gloves

Stainless steel safety bars are clinched on the back of the hand and front of the fingers to provide maximum protection from puncture wounds. This glove is not bite-proof.

MAGNUM Length: 22 inches, Palomino leather, Dupont Kevlar felt lining. \$150.50/pr



Animal Gauntlet Gloves

Ideal for use against large, dangerous dogs and other animals with crushing bites. Heavily padded throughout, but if not required, simply remove the outer layer. Inner glove features soft elk hide for dexterity plus padded gauntlet. This glove offers the maximum crushing protection. This glove is not bite proof.

JOR874 Small, Pair \$210.00/ea
JOR874A Medium, Pair \$210.00/ea
JOR874B Large, Pair \$210.00/ea



Jorvet Gauntlet Gloves

Penetration protection gloves, plus good dexterity. These gloves are heavy-duty cowhide plus extra-long suede gauntlets. Fully-lined with Kevlar felt. Perfect for felines or birds. This glove is not bite-proof.

JOR791 Small, Pair 18" \$143.00/pr
JOR791M Large, Pair 23" \$154.00/pr



Trapper Handling Gloves

Similar design features as the Warden but with an extra wide bell cuff for use over heavy-clothing or foul weather gear. An easy-to-use nylon take up strap keeps the cuff securely in place. This glove is not bite-proof.

TRAPPER Length: 22 inches, Palomino leather, Dupont Kevlar felt lining. \$135.00/pr



Grooming Gloves

These cat grooming gloves are sold by the pair. Specifically designed protrusions on fingers and palms cause needed friction to pick up loose hair while stroking your pet. Machine washable.

CPH116 Cat 1 Pair \$3.00/pr



Leather Restraint Gloves

Handling fractious animals can be made safer and easier with heavy-duty gloves. Light brown suede leather gloves have a padded lining for comfort and safety. Covers the forearm for real protection. One size fits all. 15 1/2" long. Not bite proof.

JOR455 Pair \$86.00/pr



Jorvet Cat/Wildlife Gloves



Cat and Wildlife Gloves. Designed for maximum dexterity and feel (often missing in protective gloves). Provides a very high level of penetration protection through a combination of special materials. The hand features high quality top grain leather completely lined with new Spectra, which is ten times stronger than Kevlar. The gauntlet's double layer of Dupont Kevlar knit resists sharp teeth, talons and claws, covering up past the elbow. In addition to penetration resistance, the outstanding feature is you hardly know you have them on. Perfect for handling creatures that can not inflict crushing type bites. Excellent for cats, birds, and small animals. These gloves are NOT bite proof. Please use with caution.

JOR872 Small \$115.00/pr
JOR872A Medium \$115.00/pr
JOR872B Large \$115.00/pr



Jorvet Resistor Restraint Gloves



Spectra lined for maximum penetration protection, yet has the dexterity of a driving glove. The gauntlet is extremely well padded and features "trauma plates" to protect against hard bites over a wide area. The back of the hand's shield protects against crushing bites but does not interfere with gripping. Ideal for working with dogs, cats and exotics. The best all around glove. Attractive black leather.

JOR873 Small \$99.00/pr
JOR873A Medium \$108.00/pr
JOR873B Large \$132.00/pr



13822 WEST BOULTON BLVD. METTAWA, IL 60045

Phone 800-544-7521



WWW.SHOPMEDVET.COM

Fax 800-204-2177

Wound Care Products

Cohesive Tape & Elastic Bandages



PowerFlex® Tape

PowerFlex® is a patented cohesive flexible bandage that eliminates the need to use pre-wrap, pressure sensitive elastic tear tape, and spray adhesives. PowerFlex® can be applied directly to the skin and provides 23 lbs. of tensile strength. PowerFlex® will not slip from sweat. PowerFlex® is a registered trademark of Andover Coated Products.

PWFLEX4 4" X 5 yds \$2.45/ea 18+\$2.10/ea



Paw Print Petflex® Tape

PetFlex®

A softer, stronger bandage, PetFlex® provides controlled compression with nonslip support to secure and protect primary dressings from dirt and moisture. It is a durable bandage that provides easy application (no need for scissors easy-to-hand tear), will not shred and is resistant to sweat and water. PetFlex® is an easy to clean, reusable fabric-based cohesive bandage that is more than double the strength of Vetrap®. All rolls are 5 yards in length.

No choice of colors, Petflex® is a registered trademark of Andover Coated products.

PWFLEX2 2" x 5 yards \$1.65/ea 36+\$1.35/ea
 PWFLEX3 3" x 5 yards \$2.10/ea 36+\$1.80/ea
 PWFLEX4 4" x 5 yards \$2.20/ea 36+\$1.90/ea



Co-Flex® Tape

Assorted colors, adheres to itself requiring no clips or fasteners, will not stick to hair. Individually shrink wrapped. No choice of colors. All rolls are 5 yards in length. Contains Latex. Co-Flex® is a registered trademark of Andover Coated Products.

COFLEX1 1" X 5 yds \$0.90/ea 30+\$0.79/ea
 COFLEX2 2" X 5 yds \$1.40/ea 36+\$1.09/ea
 COFLEX3 3" X 5 yds \$1.80/ea 24+\$1.39/ea
 COFLEX4 4" X 5 yds \$1.88/ea 18+\$1.49/ea
 COFLEX6 6" X 5 yds \$3.70/ea 12+\$3.29/ea



Oasis Cohesive Tape

Flexible cohesive bandage that adheres to itself and does not require clips or fasteners, and it will not stick to hair. Individually wrapped and is quick and easy to remove. No choice of colors.

OF1 1" x 5 yds \$0.75/ea 30+\$0.50/ea
 OF2 2" x 5 yds \$1.15/ea 36+\$0.80/ea
 OF3 3" x 5 yds \$1.45/ea 24+\$0.90/ea
 OF4 4" x 5 yds \$1.50/ea 18+\$1.00/ea
 OF6 6" x 5 yds \$3.00/ea 12+\$2.00/ea



Oasis

Coban® Tape

This self-adherent, non-adhesive elastic wrap, secures, protects, compresses, and supports. Maintains uniform compression. Won't slip or loosen. No need for clips or pins. Doesn't stick to hair or skin. Lightweight, porous, and comfortable. Moisture resistant. All rolls are 5 yards in length. No choice of colors. Coban® is a registered trademark of 3M.

1581 1" X 5 yds \$1.50/ea
 1582 2" X 5 yds \$1.99/ea
 1583 3" X 5 yds \$2.50/ea
 1584 4" X 5 yds \$3.00/ea
 1586 6" X 5 yds \$3.50/ea

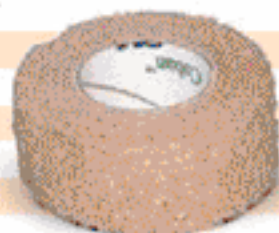

Petflex® Tape

PetFlex®

A softer, stronger bandage, PetFlex® provides controlled compression with nonslip support to secure and protect primary dressings from dirt and moisture. It is a durable bandage that provides easy application (no need for scissors easy-to-hand tear), will not shred and is resistant to sweat and water. PetFlex® is an easy to clean, reusable fabric-based cohesive bandage that is more than double the strength of Vetrap®. All rolls are 5 yards in length.

No choice of colors, Petflex® is a registered trademark of Andover Coated products.

PETFLEX1 1" X 5 yds \$1.00/ea 30+\$0.80/ea
 PETFLEX2 2" X 5 yds \$1.55/ea 36+\$1.25/ea
 PETFLEX3 3" X 5 yds \$2.00/ea 24+\$1.70/ea
 PETFLEX4 4" X 5 yds \$2.10/ea 18+\$1.80/ea



Elastic Bandage

Oasis

Economical and reusable, elastic bandages offer balanced stretch and compression. Made of rubber-reinforced high-quality cotton yarn, these bandages can be laundered and sterilized.



By The Roll

EB2 2", 5 Yards Stretched Length \$0.30/ea
 EB3 3", 5 Yards Stretched Length \$0.50/ea
 EB4 4", 5 Yards Stretched Length \$0.55/ea
 EB6 6", 5 Yards Stretched Length \$0.75/ea

By The Bag

REB2 2" ACE-TYPE, 12/BG \$3.00/bg
 REB3 3" ACE-TYPE, 12/BAG \$4.95/bg
 REB4 4" ACE-TYPE, 12/BAG \$5.95/bg
 REB6 6" ACE-TYPE, 12/BAG \$7.95/bg



Elastic Adhesive Bandage

Similar design to Elastikon® from J & J but at considerable savings. This stretchable tan woven fabric is a very familiar looking tape with red centering line.

JOR1030A 2", 6pk, 5 yds. L \$14.10/pk
 JOR1030B 3", 4pk, 5 yds. L \$14.10/pk
 JOR1030C 4", 6pk 5 yds. L \$28.50/pk



Wound Care Products

Tape; Porous, Elastic, Micropore & Surgical Adhesive



Porous Tape



Oasis Porous Tape

Oasis Porous Tape is one of the strongest tapes you can find. We pride ourselves in the quality of this tape and trust you will find out why we are excited to offer it to you with considerable savings over similar products. Try a roll. You will never use any other tape again! All rolls are 10 yards in length.



| | | |
|-------|----------------------|-------------|
| PT5 | 1/2" X 10 yds 24/box | \$10.95/box |
| PT1 | 1" X 10 yds 12/box | \$10.95/box |
| PT1.5 | 1.5" X 10 yds 6/box | \$10.95/box |
| PT2 | 2" X 10 yds 6/box | \$10.95/box |

\$10.95/box

Zonas[®] Porous Tape

Strong, yet easy to tear cloth tape. Reliable immobilization of sprains. Use when rigid strapping tape is required. 10 yards in length. Zonas[®] is a registered trademark of Johnson and Johnson.



| | | |
|--------|----------------------|-------------|
| JJS106 | 2" X 10 yds 6/box | \$15.99/box |
| JJS109 | 1/2" X 10 yds 24/box | \$15.99/box |
| JJS104 | 1" X 10 yds 12/box | \$15.99/box |
| JJS107 | 3" X 10 yds 4/box | \$15.99/box |



Micropore[®] Tape

Get excellent breathability and comfort with lightweight Micropore paper tape. It holds fast even when wet and won't harm delicate wound areas. Hypoallergenic. Micropore[®] is a registered trademark of 3M.

| | | |
|--------|----------------------|------------|
| 1530-0 | 1/2" X 10 yds 24/box | \$8.99/box |
| 1530-1 | 1" X 10 yds 12/box | \$8.99/box |
| 1530-2 | 2" X 10 yds 6/box | \$8.99/box |
| 1530-3 | 3" X 10 yds 4/box | \$8.99/box |



\$8.99/box

Transpore[®] Tape

Perforated for easy tearing and porous for greater breathability. Transpore conforms and stretches to accommodate body movement. Because it's clear it allows regular monitoring. Transpore[®] is a registered trademark of Johnson & Johnson.



| | | |
|--------|----------------------|-------------|
| 1527-0 | 1/2" X 10 yds 24/box | \$15.99/box |
| 1527-1 | 1" X 10 yds 12/box | \$15.99/box |
| 1527-2 | 2" X 10 yds 6/box | \$15.99/box |
| 1527-3 | 3" X 10 yds 4/box | \$15.99/box |



Eye pad

Eye Pads: These sterile Eye Pads are made with a soft non-woven cover, over an absorbent cotton filler. Compressed edges help reduce lining. 1-5/8" x 2-5/8".

| | | |
|--------|---------------|------------|
| EYEPAD | Sterile 50/bg | \$5.99/box |
|--------|---------------|------------|



Elastic Tape



Oasis Elastic Adhesive Tape

Oasis Elastic Adhesive Tape Provides Even Compression and Firm Support. Cotton elastic cloth tape features a strong rubber-based adhesive to permit flexibility of joints without the loosening of tape. Ideal for dynamic/pressure dressings requiring elasticity. Molds to body contours.

By The Roll

| | | |
|----------|------------|-------------|
| EA1-EACH | 1" X 5 yds | \$1.49/roll |
| EA2-EACH | 2" X 5 yds | \$2.49/roll |
| EA3-EACH | 3" X 5 yds | \$3.49/roll |
| EA4-EACH | 4" X 5 yds | \$4.49/roll |

By The Box

| | | |
|-----|-------------------|-------------|
| EA1 | 1" X 5 yds 12/box | \$12.99/box |
| EA2 | 2" X 5 yds 6/box | \$12.99/box |
| EA3 | 3" X 5 yds 4/box | \$12.99/box |
| EA4 | 4" X 5 yds 6/box | \$24.99/box |



Starting At
\$1.49/roll

Elastikon[®] Tape

Helps to maintain constant controlled pressure. It comfortably ensures a custom fit around hard to tape areas. Excellent adhesion. Unsurpassed strength. All rolls are 5 yards in length stretched. Elastikon[®] is a registered trademark of Johnson & Johnson.

| | | |
|--------|---------------------|-------------|
| JJS172 | 1" X 2.5 yds 12/box | \$20.99/box |
| JJS174 | 2" X 2.5 yds 6/box | \$20.99/box |
| JJS175 | 3" X 2.5 yds 4/box | \$20.99/box |
| JJS177 | 4" X 2.5 yds 6/box | \$39.99/box |

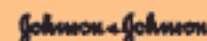

Jorvet Surgical Adhesive Tape

High quality "athletic" white porous cloth tape that can be torn easily. Priced at considerable savings.



| | | |
|---------|--------------------------------|-------------|
| JOR20AN | 1" W. x 10 yds L. 12 rolls/box | \$14.30/box |
| JOR20EN | 2" W. x 10 yds L. 6 rolls/box | \$14.30/box |
| JOR20ON | 3" W. x 10 yds L. 6 rolls/box | \$22.80/box |
| JOR20E | 3" W. x 10 yds L. 6 rolls/box | \$13.00/box |
| JOR20EN | 4" W. x 10 yds L. 6 rolls/box | \$30.00/box |



Find that instrument you need in our Instrument Section



13822 WEST BOULTON BLVD. METTAWA, IL 60045

Phone 800-544-7521

179

WWW.SHOPMEDVET.COM

Fax 800-204-2177

Wound Care Products



Dressing, Intracell & Silver Sulfadiazine

Non-Adherent Dressing

The non-adherent pad is a unitized dressing with an absorbent inner layer of fiber that is laminated between two thin, highly porous polyethylene net facing layers. Designed specifically to help prevent over hydration and maceration at the wound site and surrounding skin, the pad allows for a shorter healing time. This dressing may be used with or without a secondary dressing, depending on the need for additional protection or absorption. It will not stick to the wound! Compare and Save!! These are exactly the same as top name brands with a lower price.



| | | |
|-----------|-----------------------|------------|
| NA2X3 | 2" X 3" 100/bx | \$5.49/bx |
| NA2X3-CS1 | 2" X 3" 100/bx 1200/C | \$49.00/cs |
| NA3X4 | 3" X 4" 100/bx | \$8.99/bx |
| NA3X4-CS | 3" X 4" 100/bx 1200/C | \$79.00/cs |

as low as
\$5.49/bx

BSN Specialist Cast Padding

Cotton and Rayon Blend for excellent absorption. Micro-pleated design results in conformability, protection, and ease of application.



| | | |
|------|-------------------|------------|
| 9062 | 2" x 4yd, 24/pack | \$14.25/pk |
| 9043 | 3" x 4yd, 12/pack | \$9.50/pk |
| 9044 | 4" x 4yd, 12/pack | \$14.50/pk |
| 9046 | 6" x 4 yds, 6/pk | \$10.50/pk |

Jorvet Transparent Dressing

These transparent semi-permeable dressings are extensively used in human medical cases. Any person who has had an IV line most likely has worn one. In addition these dressings are useful in covering simple wounds in areas that might be exposed to high of levels of contamination, but don't need layers of bandaging material.

- Transparency: the film is ultra thin so observation of wound site is possible.
- Permeable: skin is able to "breathe" as the film is permeable to gas and vapor.
- Bacteria and waterproof: keeps contaminants and water out that may be contacted in day to day living.
- Low sensitivity/viscosity: no irritation to wound and is not painful when removed.
- Ultra thin and high elasticity: compliant binding on skin along body curves. Also a comfortable fit.
- Numerous configurations for various applications
- Sterile and inexpensive to use

| | | |
|----------|--------------------|------------|
| JOR1090B | 6cm X 7cm 100/bx | \$22.80/ea |
| JOR1090C | 10cm X 12cm, 50/bx | \$35.40/ea |

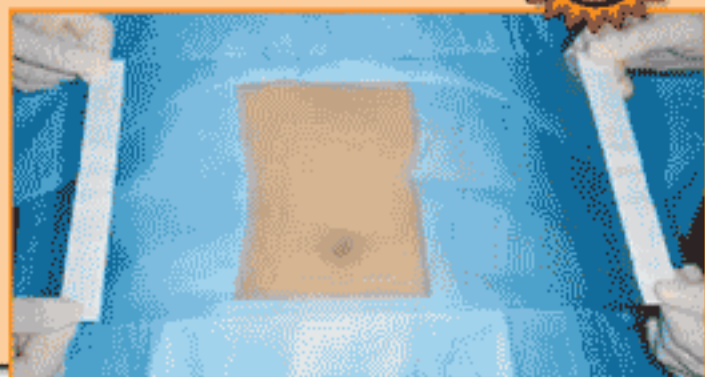

Combine Dressing

Combine Pads consist of three key layers: outer nonwoven layer to wick, fluff filler to absorb and disperse fluid and wet proof moisture barrier to retard fluid strike-through. These pads act as a reservoir, reduce pooling and protect against contamination. Non-Sterile 50 per bag



| | | |
|------------|----------------------|------------|
| AB05X9 | 5" X 9", 50/Bag | \$6.99/pk |
| AB08X7.5 | 8" X 7.5" 50/Bag | \$6.99/pk |
| AB08X7.5CS | 8 x 7.5" 576/case | \$34.95/cs |
| AB08X10 | 8" X 10" 50/Bag | \$9.99/pk |
| AB08X10CS | 8" X 10", NS, 432/CS | \$44.99/cs |

Abdominal (Combine) Pad

Super absorbent abdominal pads feature a soft non-woven outer layer that quickly wicks fluid to a cellulose center. This thick layer of cellulose quickly absorbs and disperses fluids laterally to prevent pooling. Hydrophobic back impedes strike through and all edges are sealed to prevent linting.



| | | |
|------------|------------------------|------------|
| AB05X9STRL | 5" x 9" 400/cs sterile | \$37.57/cs |
|------------|------------------------|------------|

Xeroform Petroleum Gauze

Petroleum gauze with xeroform, a medicating and deodorizing agent with 3 percent Bismuth Tribromophenate. Occlusive, non-adherent dressing contraindicated for draining wounds. Sterile, Latex-free



| | | |
|------------|-----------------|------------|
| NON253180Z | 1" x 8", 12/box | \$8.99/bx |
| NON253220Z | 2" x 2", 12/box | \$9.99/bx |
| NON253440Z | 4" x 4", 12/box | \$11.99/bx |
| NON253590Z | 5" x 9", 12/box | \$12.99/bx |

Composite Dressing

Stratasorb Composite Island Dressing: Stratasorb Composite Island Dressing Has Four Distinct Layers Designed To Cover All Stages Of Wound Care. Layer 1, A Non-Adherent Contact Layer, Protects The Wound Site And Will Not Stick To Granulating Tissue. Layer 2, A Soft Pad, Absorbs Drainage. Layer 3, A Non-Woven Backing With An Adhesive Border, Securely Holds The Contact Pad In Place. Layer 4, A Semi-Occlusive, Polyurethane Film, Helps Deter External Contaminants And Maintain An Optimal Wound Environment. Rectangular Shape Is Designed For Post-Op Applications.



| | | |
|----------|-----------------------------------|-------------|
| MSC3044Z | 4" x 4" (2.5" x 2.5" pad), 10/box | \$25.29/box |
| MSC3066Z | 6" x 6" (4" x 4" pad) 10/box | \$47.96/box |

latexfree

Silver Sulfadiazine Cream

| | | |
|-----------|------------------|------------|
| RKSSD-25 | 1%, 25 gram tube | \$3.65/ea |
| RKSSD-50 | 1%, 50 gram jar | \$4.95/ea |
| RKSSD-400 | 1%, 400 gram jar | \$15.50/ea |



Intracell Powder

| | | |
|-------------|------|-------------|
| RKXWIND-POW | 45gm | \$20.00/btl |
|-------------|------|-------------|



13822 WEST BOULTON BLVD. METTAWA, IL 60045

Phone 800-544-7521

180

WWW.SHOPMEDVET.COM

Fax 800-204-2177

Wound Care Products

Ace Bandages, Adhesive Bandages & Wound Pads



Unna's Boot

Suited for a wide variety of applications, it offers firm even pressure for sustained periods of time. Coated with zinc-oxide, to promote healing for a wide variety of dermatitis and dermal ulcers. One roll per package!

| | | |
|-------|------------------------|-----------|
| UNNA3 | 3", 10 Yards in length | \$5.95/ea |
| UNNA4 | 4", 10 Yards in length | \$6.95/ea |



Adhesive Bandages

Easy opening plastic adhesive bandages go on fast and won't stick to wound, various manufacturers.

| | | |
|-------|------------------|-----------|
| BA1 | 1" X 3" 100/bx | \$2.99/bx |
| BA3/4 | 3/4" X 3" 100/bx | \$2.49/bx |

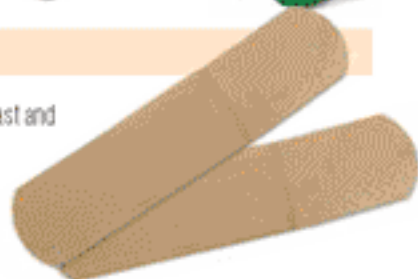

Jorvet Esmark Bandage/Tourniquet

Latex roll that is excellent for bloodless surgical field (i.e., equine lower limb). 

| | | |
|----------|-----------------------|-----------|
| JOR486A | 4" x 12', Sterile | \$7.20/ea |
| JOR486AN | 4" x 12', Non-Sterile | \$4.65/ea |
| JOR486B | 3" x 9', Sterile | \$5.10/ea |
| JOR486EN | 3" x 9', Non-Sterile | \$4.00/ea |

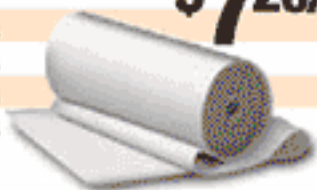

as low as
\$7.20/ea

Ace Bandage w/self Close Velcro

These are the familiar beige stretch bandages. They are very useful for long standing injuries that require a large number of bandage changes. Choice of two closure styles. Individually wrapped. Both ends have velcro for easy starting and closure.

| | | |
|---------|----------------------|------------|
| JOR859 | 2"W 186" L stretched | \$21.25/dz |
| JOR859A | 3"W 210" L stretched | \$26.75/dz |
| JOR859B | 4"W 210" L stretched | \$32.75/dz |
| JOR859C | 6"W 210" L stretched | \$54.00/dz |



Jorvet X-span Tubular Dressing

This tube-shaped gauze material is designed to hold a primary dressing in place. It is excellent for use on body parts that are difficult to secure with tape (i.e., the head). The material has a remarkable amount of stretch for optimum fit. Mid-line colored stripe for orientation.

| | | |
|---------|---------------|------------|
| JOR292 | 16mm (5/8") | \$17.40/ea |
| JOR292A | 25mm (1") | \$17.40/ea |
| JOR292B | 32mm (1 1/4") | \$21.00/ea |
| JOR292C | 50mm (2 3/8") | \$26.70/ea |
| JOR292E | 75mm (3") | \$38.00/ea |



Ace Elastic Compression Bandage

These are the familiar beige stretch bandages. They are very useful for long standing injuries that require a large number of bandage changes. Choice of two closure styles. Individually wrapped.

| | | |
|---------|-----------------------------|------------|
| JOR858 | 2"W 186" L stretched, 12/bx | \$14.30/dz |
| JOR858A | 3"W 186" L stretched, 12/bx | \$16.30/dz |
| JOR858B | 4"W 186" L stretched, 12/bx | \$20.30/dz |
| JOR858C | 6"W 186" L stretched, 12/bx | \$26.30/dz |

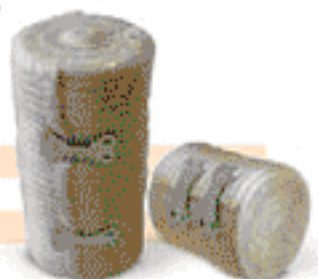

Absorbent Wound Pads

These pads lift and remove wound exudate in the same way that a disposable diaper works. The outer layers are a thin layer that allows moisture to pass into the thick middle absorbent layer. This keeps the wound surface dry. 5" x 9" green midline strip. It can be trimmed for sizing. Sterile package in chevron pouch. 25 pieces/box. Less expensive and more absorbent than telfa pads. 

| | | |
|---------|---------------|-----------|
| JOR1079 | 5" x 9", 25pk | \$4.50/pk |
|---------|---------------|-----------|



\$4.50/pk

X-Heavy Moleskin

| | | |
|--------|-------------|------------|
| MS12X5 | 12" x 5 yds | \$28.95/rl |
| MS2X5 | 2" x 5 yds | \$5.95/rl |



Jorvet Equine Leg Wrap

Made of soft quality bulk cotton which is covered on both sides with a permeable thin layer of nonwoven material. The wrap acts much like a diaper in that the wound exudate is lifted and absorbed into the thick middle cotton layer.

A dark mark mid-line runs full length to give proper orientation during application. A wide variety of materials and sizes are now available.



| | | |
|----------|------------------------------------|------------|
| JOR849 | Large Bulk Roll, 12" x 10 yds. | \$20.00/ea |
| JOR849A | Large Bulk Roll, 14" x 10 yds. | \$21.00/ea |
| JOR849B | Large Bulk Roll, 16" x 10 yds. | \$25.80/ea |
| JOR849AN | Individual, Non-sterile, 12" x 36" | \$4.10/ea |
| JOR849BN | Individual, Non-sterile, 12" x 42" | \$3.75/ea |
| JOR849CN | Individual, Non-sterile, 14" x 42" | \$4.05/ea |
| JOR849DN | Individual, Non-sterile, 16" x 54" | \$6.00/ea |
| JOR849AS | Individual, Non-sterile, 12" x 36" | \$4.80/ea |
| JOR849BS | Individual, Non-sterile, 12" x 42" | \$4.80/ea |
| JOR849CS | Individual, Non-sterile, 14" x 42" | \$4.95/ea |
| JOR849DS | Individual, Non-sterile, 16" x 54" | \$6.60/ea |



13822 WEST BOULTON BLVD. METTAWA, IL 60045

Phone 800-544-7521

181

WWW.SHOPMEDVET.COM

Fax 800-204-2177

Angelica Angelstat® Scrubs

Designed for comfort, our popular 50% polyester / 50% cotton AngelStat® fabric is soft yet durable. Reversible pants feature drawstring waist and back pocket inside and out. Pants also feature four-panel construction (double needle inseam and out seam) for better fit. Drawstrings are color coded for easy size identification. Generously cut sizes XS-3XL. Add \$2.00 for XX-Large & \$3.00 for XXX-Large sizes. Angelstat® is a registered trademark of Medcrest. These Scrubs always gets the job done.



| | | | | | |
|------------|-----------------|-------------------|-----------------|---------------------|------------------|
| White W | Ciel Blue CB | Misty Green MG | Sapphire SAP | Emerald Green EG | Navy N |
| Gray G | Peacock PEC | Jade Green JG | Purple PUR | Hunter Green HG | Raspberry RAS |

Call for available colors and sizes.
No returns on embroidered items. All sales are final
Add \$2.00 for XX-Large & \$3.00 for XXX-Large sizes.

Shirts

\$8⁹⁹

Pants

\$9⁹⁹

Product# Example: (when ordering)

| Brand | Shirts or Pants | Color | Size |
|-------|-----------------|-------|------|
| AS | P | CB | XL |

AngelStat®

Angelstat® Sizing Chart (Unisex Reversible Shirt)

| Chest | XS | S | M | L | XL | XXL | XXXL |
|-------|-------|-------|-------|-------|-------|-------|-------|
| | 31-34 | 35-38 | 39-42 | 43-46 | 47-50 | 51-54 | 55-58 |

Angelstat® Sizing Chart (Unisex Reversible Pants)

| Waist | XS | S | M | L | XL | XXL | XXXL |
|-------|-------|-------|-------|-------|-------|-------|-------|
| | 26-28 | 30-32 | 34-36 | 38-40 | 42-44 | 46-48 | 50-52 |

Embroidery Available On All Angelstat® Scrubs.

Med-Vet Encore Scrubs

Med-Vet Encore Scrubs

Our top-selling Encore scrub pants are designed using the most generous cut in the industry. Encore Cloth is a comfortable 45% Polyester / 55% Cotton blend guaranteeing comfort and durability. These pants feature a drawstring waist and a pocket on the back right side. Add \$2.00 for XX-Large & \$3.00 for XXX-Large sizes.

Shirts
\$7⁴⁹

Pants
\$8⁴⁹

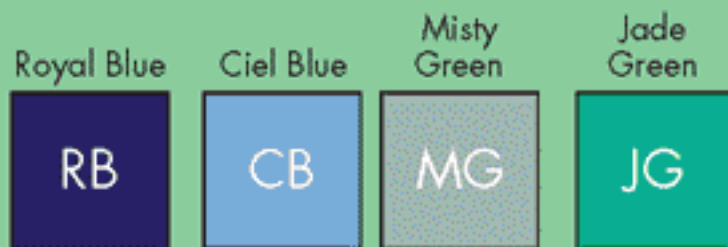

Call for available colors and sizes.
No returns on embroidered items.
All sales are final
Add \$2.00 for XX-Large & \$3.00 for XXX-Large sizes.

Product#
Example:
(when ordering)

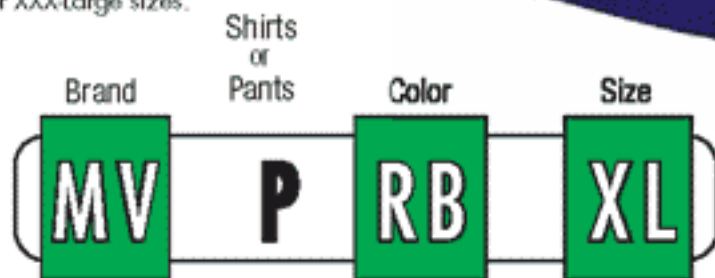

Med-Vet

| Premier Sizing Chart (Unisex Reversible Shirt) | | | | | | |
|--|-------|-------|-------|-------|-------|-------|
| Chest | S | M | L | XL | XXL | XXXL |
| | 35-38 | 39-42 | 43-46 | 47-50 | 51-54 | 55-58 |

| Premier Sizing Chart (Unisex Reversible Pants) | | | | | | |
|--|-------|-------|-------|-------|-------|-------|
| Waist | S | M | L | XL | XXL | XXXL |
| | 30-32 | 34-36 | 38-40 | 42-44 | 46-48 | 50-52 |

Embroidery Available On All Med-Vet Premier Scrubs.

ADD Embroidery TO YOUR FAVORITE SCRUB

Embroidery Available On All Angelica & Med-Vet Encore Scrubs.

One Line

\$6⁰⁰

Two Lines

\$10⁰⁰



WHAT SCRUBS CAN I EMBROIDER?

- CLOSEOUT Scrubs (Solid Colors Only)
- Regular Line Scrubs
- Lab Coats

**COMPARE
AND SAVE**

CALL FOR AVAILABLE COLORS AND SIZES!

No Returns on embroidered items. All sales are final.

13822 WEST BOULTON BLVD. METTAWA, IL 60045

WWW.SHOPMEDVET.COM





Phone 800-544-7521

184

Fax 800-204-2177

CUSTOM EMBROIDERY ORDER FORM

We offer computerized custom embroidery on most of our garments. If you wish to have your name or clinic name embroidered, you can choose from a variety of different styles below.

| | | | | | |
|--|---|--|---|--|--|
| VETERINARY  | MEDICAL  | PODIATRY  | DENTISTRY  | FONTS (CHOOSE ONE): -Dr. Smith, D.V.M. (Script) -DR. SMITH D.V.M. (Block) | STYLE (CHOOSE ONE): COST A- Emblem (\$ 6.00) B- 1 Line of type (\$ 6.00) C- * Various (\$10.00) -1 Line of type & emblem -2 Lines of type (Script, Block or both) |
|--|---|--|---|--|--|

PLEASE ALLOW 7-10 DAYS DELIVERY TIME.

When ordering custom embroidery:

- Please print name clearly.
- Indicate lettering style desired.
- Maximum 18 characters which includes spaces, etc.

Please call for quote on custom logos
OR
Special Requests.

* Must be located on the same side of garment.

| | | | | |
|--|-------------|--|---|--|
| ITEM# | QTY: | Thread Color: <input type="checkbox"/> Black <input type="checkbox"/> White <input type="checkbox"/> Gold | Font: <input type="checkbox"/> Script <input type="checkbox"/> Block | Style: <input type="checkbox"/> A <input type="checkbox"/> B <input type="checkbox"/> C |
| DESCRIPTION: (Please print legibly.) MAXIMUM 18 characters which includes spaces, etc. | | | | |
| Embroidery Price: \$ | | | | |

| | | | | |
|--|-------------|--|---|--|
| ITEM# | QTY: | Thread Color: <input type="checkbox"/> Black <input type="checkbox"/> White <input type="checkbox"/> Gold | Font: <input type="checkbox"/> Script <input type="checkbox"/> Block | Style: <input type="checkbox"/> A <input type="checkbox"/> B <input type="checkbox"/> C |
| DESCRIPTION: (Please print legibly.) MAXIMUM 18 characters which includes spaces, etc. | | | | |
| Embroidery Price: \$ | | | | |

| | | | | |
|--|-------------|--|---|--|
| ITEM# | QTY: | Thread Color: <input type="checkbox"/> Black <input type="checkbox"/> White <input type="checkbox"/> Gold | Font: <input type="checkbox"/> Script <input type="checkbox"/> Block | Style: <input type="checkbox"/> A <input type="checkbox"/> B <input type="checkbox"/> C |
| DESCRIPTION: (Please print legibly.) MAXIMUM 18 characters which includes spaces, etc. | | | | |
| Embroidery Price: \$ | | | | |

| | | | | |
|--|-------------|--|---|--|
| ITEM# | QTY: | Thread Color: <input type="checkbox"/> Black <input type="checkbox"/> White <input type="checkbox"/> Gold | Font: <input type="checkbox"/> Script <input type="checkbox"/> Block | Style: <input type="checkbox"/> A <input type="checkbox"/> B <input type="checkbox"/> C |
| DESCRIPTION: (Please print legibly.) MAXIMUM 18 characters which includes spaces, etc. | | | | |
| Embroidery Price: \$ | | | | |

| | | | | |
|--|-------------|--|---|--|
| ITEM# | QTY: | Thread Color: <input type="checkbox"/> Black <input type="checkbox"/> White <input type="checkbox"/> Gold | Font: <input type="checkbox"/> Script <input type="checkbox"/> Block | Style: <input type="checkbox"/> A <input type="checkbox"/> B <input type="checkbox"/> C |
| DESCRIPTION: (Please print legibly.) MAXIMUM 18 characters which includes spaces, etc. | | | | |
| Embroidery Price: \$ | | | | |

Please let us know if you need an additional order form. In order to confirm all information is correct, please fill out the contact information below, sign and date.
No returns on embroidered items. All sales final.

| |
|-----------------------------|
| Total Price \$ _____ |
|-----------------------------|

Company Name _____

Contact Phone:(____) _____ Fax: _____

Name (please print) _____

Signature _____ Date _____

Gowns



Cloth Reusable Surgeon Gown (A)

100% cotton surgeon gown with tunnel belt, unisex. Finest quality surgeon gowns have sturdy double-stitched seams. Full 50" to 56" from shoulder to hem. Raglan sleeves with stockinette cuffs.

| | | |
|----------|----------------------|------------|
| AHSGM-C | Medium, 100% Cotton | \$19.99/ea |
| AHSGM-C | Medium, 100% Cotton | \$19.99/ea |
| AHSSL-C | Large, 100% Cotton | \$19.95/ea |
| AHSSQL-C | X-Large, 100% Cotton | \$19.99/ea |



Sterile Surgeon Gown (B)

Made from SMS fabric, these sterile surgical gowns come individually packaged. Full back with wrap-around style and knit sleeves. Light blue. Comes with sterile towel.

| | | | |
|--------|----------|-----------|---------------------|
| OSGL | Large | \$3.29/ea | 35+\$2.99/ea |
| OSGXXL | XX-Large | \$3.29/ea | 35+\$2.99/ea |
| OSGXL | X-Large | \$3.29/ea | 35+\$2.99/ea |
| OSGM | Medium | \$3.29/ea | 35+\$2.99/ea |



Cloth Reusable Surgical Gown With Panel (C)

Critical-Coverage Gown. Surgical gown with chest and arm panel for extra protection.

| | | |
|----------|---------|------------|
| AHSSL-P | Large | \$27.99/ea |
| AHSSQL-P | X-Large | \$27.99/ea |

Premium Sterile Surgeon Gown (D)

Sterile surgeon gown comes individually wrapped with towel. These gowns are made of a non-woven material that helps provide a barrier to blood, body fluids and pathogens. They offer a high level of protection without compromising comfort. They are cut wider through the chest and sleeves for a roomier fit and feature a velcro-style neck closure that allows the neckline to easily adjust to a wide variety of people. In addition, the velcro-style closure helps prevent gapping in the front of the gown to further protect against fluids. The gowns are very low lining, minimizing the risk of introducing particles into the O.R.

| | | | |
|---------|----------|-----------|---------------------|
| AHSSGL | Large | \$3.49/ea | 30+\$3.29/ea |
| AHSSQL | X-Large | \$3.49/ea | 30+\$3.29/ea |
| AHSSGOL | XX-Large | \$3.69/ea | 30+\$3.59/ea |



Polyethylene Coated Gown (E)

Polyethylene coated polypropylene gowns provide a high level of fluid protection. Waist and neck ties ensure that gowns remain securely in place to protect clothes.

| | | |
|---------|---------------|------------|
| 27114 | 50/Cs Regular | \$49.95/cs |
| 27114XL | 50/Cs X-Large | \$49.95/cs |



FOR DISINFECTANTS, INSTRUMENT CLEANERS & STERILIZATION SUPPLIES..SEE OUR STERILIZATION SECTION IN THIS CATALOG



Gowns, Caps & Shoecovers



Fluid Resistant Isolation Gowns (F)

Made from Lightweight Fluid-Resistant 4-Ply SMS material. Gowns feature strong seams to withstand fluids. Gowns are generously sized for full coverage and flexibility and are constructed with waist and neck ties to ensure a secure fit.

| | | |
|---------|---------------|------------|
| 27236 | 50/Cs Regular | \$29.00/cs |
| 27236XL | 50/Cs X-Large | \$39.00/cs |

Disposable Non-Sterile Surgeon Gown (G)

These gowns are made of a non-woven material that helps provide a barrier to blood, body fluids and pathogens. They offer a high level of protection without compromising comfort. They are cut wider through the chest and sleeves for a roomier fit and feature a velcro-style neck closure that allows the neckline to easily adjust to a wide variety of people. In addition, the velcro-style closure helps prevent gapping in the front of the gown to further protect against fluids. The gowns are very low linting, minimizing the risk of introducing particles into the O.R.

| | | |
|---------|----------|-----------|
| MVGNSL | Large | \$1.99/ea |
| MVGNL | X-Large | \$1.99/ea |
| MVGNLXL | XX-Large | \$2.29/ea |

only \$1.99/ea

Bouffant Cap

- Soft
- Breathable
- Elastic band opening
- Meets NFPA standards. No color choice

| | | |
|----------|--------|-----------|
| BOUFFANT | 100/bx | \$8.00/bx |
|----------|--------|-----------|



Surgeon Cap

- Durable
- Soft and comfortable
- Tie-on
- One size fits all
- Blue 100/bx

| | | |
|---------|--------|-----------|
| SURGCAP | 100/bx | \$9.99/bx |
|---------|--------|-----------|



Shoecover

A soft, durable and lightweight shoecover. Has a fuller cut and a more generous heel and instep. Designed to fit both large and small shoe sizes comfortably and snugly. 100 per box.

| | | |
|--------------|------------------|------------------------------|
| SHOECOVER | 100/bx | \$8.00/bx |
| SHOECOVER-NS | NON-SKID, 100/bx | \$8.95/bx 2+\$8.00/bx |
| SHOECOVER-XL | 200/bx X-Large | \$23.90/bx |

Jorvet Shoecover

Disposable Shoe Cover. Non-conductive and non-skid. Blue. Universal size. Bulk packaged in dispensing box.

| | | |
|--------|------------------|------------|
| JOR730 | 100/bx, 3bx/case | \$35.00/cs |
|--------|------------------|------------|



Disposable Apron

All purpose garment. Oil and chemical resistant. Great for jobs around the kennel/clinic. Dispensing box.

| | | |
|--------|-------------------|------------|
| GLX390 | 32" x 50", 100/cs | \$19.95/cs |
|--------|-------------------|------------|

Jorvet Disposable Aprons

| | | |
|---------|--------------------------------|---------------|
| JOR345M | 28" x 46" long, 100/pk, 100/pk | \$59.00/pk/pk |
|---------|--------------------------------|---------------|

GLX390



JOR345M



Rubberized OB Supplies & Coveralls

Jorvet Rubberized OB Suit

Rubberized OB Suit. With pants and jacket. **Jorvet**

| | | |
|------------|----------------|-------------|
| JOR30SR-S | Small, (2 pc) | \$183.00/ea |
| JOR30SR-L | Large (2pc) | \$183.00/ea |
| JOR30SR-M | Medium (2pc) | \$183.00/ea |
| JOR30SR-XL | X-Large (2 pc) | \$183.00/ea |

Rubberized OB Cover-All Suit

Rubberized OB CoverAll Suit. One piece. **Jorvet**

| | | |
|-------------|---------|-------------|
| JOR30CSR-S | Small | \$164.00/ea |
| JOR30CSR-M | Medium | \$168.00/ea |
| JOR30CSR-L | Large | \$168.00/ea |
| JOR30CSR-XL | X-Large | \$177.00/ea |

Rubberized OB Overalls

Easy to snap-on Suspenders. **Jorvet**

| | | |
|----------|---------|-------------|
| JOR30OS | Small | \$104.00/ea |
| JOR30OM | Medium | \$104.00/ea |
| JOR30OL | Large | \$110.00/ea |
| JOR30OXL | X-Large | \$104.00/ea |

Total OB Sleeve

The "Total" OB Sleeve. This new product gives additional coverage to the whole shoulder and under arm area. No need for clamps to hold in place or a separate shoulder protector. Helps reduce laundry expense and reduces accidental manure stains and smell. This glove is sensitive but strong, 1-mil thick with strong smooth seams. Package is 50 sleeves in a pull out dispensing box.

Jorvet

| | | |
|----------|---------------------|------------|
| JOR30OD | Regular (Box of 50) | \$21.00/bx |
| JOR30ODS | Small (box of 50) | \$18.00/bx |



Tyvek Coveralls

These latex-free Tyvek coveralls offer enough protection for use in the O.R. "clean" area. These coveralls are sturdy and feature a full-length zipper for ease of use.

| | | |
|-----------------|-----------------|-------------|
| COVERALL-TY-L | Large, 25/cs | \$162.30/cs |
| COVERALL-TY-XL | X-Large, 25/CS | \$167.00/cs |
| COVERALL-TY-XXL | XX-Large, 25/CS | \$172.20/cs |

Boot Cover (Non-Skid Impervious)

Non-Skid impervious boot covers with Polyethylene coating reduces chance of fluid penetration. These latex-free boot covers are ultrasonically sealed on all sides. The seamless cover has no holes, omitting the risk of fluid penetration. The convenient Velcro® strap is heat-sealed to the boot and allows the wearer to adjust the fit. They feature non-skid tread for increased stability.

| | | |
|--------------|--------|-------------|
| BOOTCOVER | 150/cs | \$143.45/cs |
| BOOTCOVER-XL | 150/cs | \$149.90/cs |



Rubberized OB Smock

This smock features the special easy-to-clean arm shields. Very durable. **Jorvet**

| | | |
|-----------|---------|-------------|
| JOR30R-L | Large | \$113.00/ea |
| JOR30R-S | Small | \$110.00/ea |
| JOR30R-XL | X-Large | \$113.00/ea |
| JOR30R-M | Medium | \$113.00/ea |

Rubberized OB Pants

Rubberized OB Pants only. **Jorvet**

| | | |
|-----------|--------|------------|
| JOR30PR-S | Small | \$73.00/ea |
| JOR30PR-M | Medium | \$73.00/ea |
| JOR30PR-L | Large | \$73.00/ea |

JOR30JR & JOR30PR



JOR29a

Rubberized OB Jacket

Rubberized OB Jacket only. **Jorvet**

| | | |
|-----------|---------|-------------|
| JOR30JR-M | Medium | \$110.00/ea |
| JOR30JR-S | Small | \$110.00/ea |
| JOR30JRXL | X-Large | \$126.00/ea |
| JOR30JR-L | Large | \$116.00/ea |

Rubberized OB Apron (H)

Rubberized OB Apron. Suitable for wearing in conjunction with JOR29 or JOR29c. **Jorvet**

| | | |
|--------|----------------------------|------------|
| JOR29A | Rubberized, 120cm or 48" L | \$37.50/ea |
|--------|----------------------------|------------|

OB Shoulder Protector

This is the original Danish import, where the arm passes through an opening in the special easy-to-clean rubber shield. There's no bunching of the material in the arm area. If worn in conjunction with a rubber apron, it serves as an OB smock. Protector lies under opposite arm. **Jorvet**

| | | |
|-------|-------------------|------------|
| JOR29 | Heat-sealed seams | \$45.00/ea |
|-------|-------------------|------------|

OB Shoulder Cuff **Jorvet**

Basically the same as JOR29 above, but less area is covered. Very handy in conjunction with disposable or rubber sleeves.

| | | |
|--------|-------------------|------------|
| JOR29C | Heat-sealed seams | \$33.00/ea |
|--------|-------------------|------------|

Disposable Plastic Boots

Fits over cowboy boots and large work shoes. Handy tie feature keeps boots on tight. Blue. **Jorvet**

| | | |
|----------|--|------------|
| JOR100BL | Heavy 4 ml thickness. 21"H x 16"L. 50/bag. | \$18.45/pk |
| JOR100B | 4ml. 50/pk. 18"H x 14 3/4"L. | \$18.30/pk |



Breathable Coveralls

These latex-free coveralls are made of totally fluid-proof, yet breathable material. These deluxe cut coveralls are extra roomy and fit easily over street clothes for quick access to the O.R. or clean area. Each coverall features a full length zipper in front, elastic gathers in back for a superior fit and extra room in the sleeves for easy mobility. The breathable coveralls are great for extended wear periods and are a more comfortable and cost effective option to Tyvek coveralls.

| | | |
|-----------------|------------------------|-------------|
| COVERALL-BR-L | White, Large, 25/cs | \$109.05/cs |
| COVERALL-BR-XXL | White, XX-Large, 25/cs | \$114.53/cs |
| COVERALL-BR-XL | White, X-Large, 25/cs | \$109.05/cs |



SCRUBS DEPOT
Closeout Scrubs **99¢/ea**

99¢ each with every \$10 you spend. Supplies limited ACT NOW before they're Gone!

WWW.SHOPMEDVET.COM

Fax 800-204-2177

13822 WEST BOULTON BLVD. METTAWA, IL 60045

188

Phone 800-544-7521

LAB COATS

CHECK OUT OUR **NEW** LINE OF QUALITY LAB COATS

Full Length Lab Coat

Easy care 80% polyester/20% cotton poplin fabric that's designed to resist wrinkles. Button-front styling with two lower pockets, one chest pocket with pencil slot, and side vent openings for easy access to pants pockets, 42" length.

| | | |
|-------------|---------|------------|
| MDT14WHT34E | size 34 | \$15.99/ea |
| MDT14WHT36E | size 36 | \$15.99/ea |
| MDT14WHT38E | size 38 | \$15.99/ea |
| MDT14WHT40E | size 40 | \$15.99/ea |
| MDT14WHT42E | size 42 | \$15.99/ea |
| MDT14WHT44E | size 44 | \$15.99/ea |
| MDT14WHT46E | size 46 | \$15.99/ea |
| MDT14WHT48E | size 48 | \$15.99/ea |
| MDT14WHT50E | size 50 | \$17.10/ea |
| MDT14WHT52E | size 52 | \$17.10/ea |
| MDT14WHT54E | size 54 | \$18.72/ea |
| MDT14WHT56E | size 56 | \$21.04/ea |



NEW

Full Length Tall Lab Coat

| | | |
|--------------|--------------|------------|
| MDT14WHT42TE | size 42 tall | \$18.95/ea |
| MDT14WHT44TE | size 44 tall | \$18.95/ea |
| MDT14WHT46TE | size 46 tall | \$18.95/ea |
| MDT14WHT48TE | size 48 tall | \$17.95/ea |
| MDT14WHT50TE | size 50 tall | \$20.75/ea |
| MDT14WHT52TE | size 52 tall | \$19.75/ea |

Men's Lab Coat

Our premium lab coat is pre-shrunk, 100% heavyweight cotton twill for extra durability and is nicely detailed with knot button closures in front and on the back belt. With a pencil divided left breast pocket, two lower pockets and side slash openings for easy access to pants pockets. Back vent. 44" length.

| | | |
|----------|----------------|------------|
| 317TNS40 | White, Size 40 | \$28.26/ea |
| 317TNS42 | White, Size 42 | \$28.26/ea |
| 317TNS44 | White, Size 44 | \$28.26/ea |



Ladies Full Length Lab Coat

Easy care 80% polyester/20% cotton poplin. White button front lab coat with two lower pockets, one chest pocket. Tailored fit with princess style seams on back. 2-button adjustable back belt. 40" length.

| | | |
|------------|-------------|------------|
| MDT13WHT1E | Small | \$15.99/ea |
| MDT13WHT2E | Medium | \$15.99/ea |
| MDT13WHT3E | Large | \$15.99/ea |
| MDT13WHT4E | Extra Large | \$16.11/ea |
| MDT13WHT5E | XX-Large | \$17.64/ea |
| MDT13WHT6E | XXX-Large | \$17.64/ea |

NEW



Knee Length Lab Coat

Button-front style features a lapel collar, left breast pocket, two lower pockets, plain back and side slash openings for easy access to pants pockets. 41" length, 65% polyester 35% cotton.

WHITE

| | | |
|-------------|-----------|------------|
| 830440HWS | X-Small | \$16.99/ea |
| 830440HWS | Small | \$16.99/ea |
| 830440HWM | Medium | \$16.99/ea |
| 830440HML | Large | \$16.99/ea |
| 830440HXL | X-Large | \$16.99/ea |
| 830440HXXL | XX-Large | \$17.59/ea |
| 830440HXXXL | XXX-Large | \$19.16/ea |

NAVY

| | | |
|-------------|-----------|------------|
| 830440NWS | Small | \$17.99/ea |
| 830440NWM | Medium | \$17.99/ea |
| 830440NML | Large | \$17.99/ea |
| 830440NXL | X-Large | \$17.99/ea |
| 830440NXXL | XX-Large | \$21.99/ea |
| 830440NXXXL | XXX-Large | \$19.99/ea |

**TOP
SELLER**



Disposable Lab Coat

Knee length

| | | |
|----------|-----------------------------|-------------|
| J0R946SB | Ciel Blue, Small, 10/pkg | \$36.00/ea |
| J0R946MB | Ciel Blue, Medium, 10/pkg | \$36.00/ea |
| J0R946LB | Ciel Blue, Large, 10/pkg | \$35.00/pkg |
| J0R946XB | Ciel Blue, X-Large, 10/pkg | \$36.00/pkg |
| J0R946SG | Teal Green, Small, 10/pkg | \$36.00/pkg |
| J0R946MG | Teal Green, Medium, 10/pkg | \$38.00/pkg |
| J0R946LG | Teal Green, Large, 10/pkg | \$37.00/pkg |
| J0R946XG | Teal Green, X-Large, 10/pkg | \$36.00/pkg |

Hip length

| | | |
|----------|-----------------------------|------------|
| J0R945SG | Teal Green, Small, 10/pkg | \$37.00/ea |
| J0R945MG | Teal Green, Medium, 10/pkg | \$37.00/ea |
| J0R945LG | Teal Green, Large, 10/pkg | \$37.00/ea |
| J0R945XG | Teal Green, X-Large, 10/pkg | \$37.00/ea |
| J0R945SB | Ciel Blue, Small, 10/pkg | \$37.00/ea |
| J0R945MB | Ciel Blue, Medium, 10/pkg | \$37.00/ea |
| J0R945LB | Ciel Blue, Large, 10/pkg | \$37.00/ea |
| J0R945XB | Ciel Blue, X-Large, 10/pkg | \$37.00/ea |



NEW

13822 WEST BOULTON BLVD. METTAWA, IL 60045

WWW.SHOPMEDVET.COM

Phone 800-544-7521

189

Fax 800-204-2177

COATS

MED-VET'S

SCRUBS DEPOT**CLOSEOUT LIMITED SUPPLY****KNEE LENGTH (CLOTH BUTTONS)**

| | | |
|-----------|--|--------|
| X1424W-30 | LAB COAT, WHITE, KNEE LENGTH, CLOTH BUTTONS, SIZE 30 | \$5.99 |
| X1424W-32 | LAB COAT, WHITE, KNEE LENGTH, CLOTH BUTTONS, SIZE 32 | \$5.99 |
| X1424W-36 | LAB COAT, WHITE, KNEE LENGTH, CLOTH BUTTONS, SIZE 36 | \$5.99 |
| X1424W-38 | LAB COAT, WHITE, KNEE LENGTH, CLOTH BUTTONS, SIZE 38 | \$5.99 |
| X1424W-40 | LAB COAT, WHITE, KNEE LENGTH, CLOTH BUTTONS, SIZE 40 | \$5.99 |
| X1424W-42 | LAB COAT, WHITE, KNEE LENGTH, CLOTH BUTTONS, SIZE 40 | \$5.99 |

MEDIUM LENGTH (CLOTH BUTTONS)

| | | |
|-----------|---|--------|
| X1425W-30 | LAB COAT, WHITE, MED LENGTH, CLOTH BUTTONS, SIZE 30 | \$5.99 |
| X1425W-32 | LAB COAT, WHITE, MED LENGTH, CLOTH BUTTONS, SIZE 32 | \$5.99 |
| X1425W-34 | LAB COAT, WHITE, MED LENGTH, CLOTH BUTTONS, SIZE 34 | \$5.99 |
| X1425W-36 | LAB COAT, WHITE, MED LENGTH, CLOTH BUTTONS, SIZE 36 | \$5.99 |
| X1425W-38 | LAB COAT, WHITE, MED LENGTH, CLOTH BUTTONS, SIZE 38 | \$5.99 |
| X1425W-40 | LAB COAT, WHITE, MED LENGTH, CLOTH BUTTONS, SIZE 40 | \$5.99 |
| X1425W-42 | LAB COAT, WHITE, MED LENGTH, CLOTH BUTTONS, SIZE 42 | \$5.99 |
| X1425W-44 | LAB COAT, WHITE, MED LENGTH, CLOTH BUTTONS, SIZE 44 | \$5.99 |
| X1425W-46 | LAB COAT, WHITE, MED LENGTH, CLOTH BUTTONS, SIZE 46 | \$5.99 |
| X1425W-48 | LAB COAT, WHITE, MED LENGTH, CLOTH BUTTONS, SIZE 48 | \$5.99 |

MIXED LAB COATS

| | | |
|-------------|---|--------|
| 6150-0118 | LAB COAT, WHITE, KNEE LENGTH, WOMENS, SIZE 8 | \$5.99 |
| HX1269-AT9 | LAB COAT, PROTECTIVE, BLUE, STANDUP B BACK, UNISEX, X-LARGE | \$3.99 |
| HX3348-W22 | LAB COAT, WHITE, W/ KNTBTNS, UNISEX, SIZE 22 | \$5.99 |
| 6466-011-34 | LAB COAT, WHITE, KNEE LENGTH, 4 BUTTON, MENS, SIZE 34 | \$5.95 |

UNISEX KNEE LENGTH

| | | |
|------------|---|--------|
| X1623TW-32 | LAB COAT, WHITE, KNEE LENGTH, UNISEX, SIZE 32 | \$5.99 |
| X1623TW-36 | LAB COAT, WHITE, KNEE LENGTH, UNISEX, SIZE 36 | \$5.99 |
| X1623TW-40 | LAB COAT, WHITE, KNEE LENGTH, UNISEX, SIZE 40 | \$5.99 |
| X1623TW-42 | LAB COAT, WHITE, KNEE LENGTH, UNISEX, SIZE 42 | \$5.99 |

UNISEX KNEE LENGTH

| | | |
|------------|---|--------|
| X1623TW-58 | LAB COAT, WHITE, KNEE LENGTH, UNISEX, SIZE 58 | \$5.99 |
| X1624TW-36 | LAB COAT, WHITE, KNEE LENGTH, UNISEX, SIZE 36 | \$5.99 |
| X1624TW-38 | LAB COAT, WHITE, KNEE LENGTH, UNISEX, SIZE 38 | \$5.99 |
| X1624TW-52 | LAB COAT, WHITE, KNEE LENGTH, UNISEX, SIZE 52 | \$5.99 |
| X1629TW-36 | LAB COAT, WHITE, KNEE LENGTH, UNISEX, SIZE 36 | \$5.99 |
| X1631TW-28 | LAB COAT, WHITE, KNEE LENGTH, UNISEX, SIZE 28 | \$5.99 |
| X1631TW-46 | LAB COAT, WHITE, KNEE LENGTH, UNISEX, SIZE 46 | \$5.99 |

UNISEX HIP LENGTH

| | | |
|------------|--|--------|
| X1641TW-36 | LAB COAT, WHITE, HIP LENGTH, UNISEX, SIZE 36 | \$5.99 |
| X1641TW-46 | LAB COAT, WHITE, HIP LENGTH, UNISEX, SIZE 46 | \$5.99 |
| X1641TW-48 | LAB COAT, WHITE, HIP LENGTH, UNISEX, SIZE 48 | \$5.99 |
| X1641TW-50 | LAB COAT, WHITE, HIP LENGTH, UNISEX, SIZE 50 | \$5.99 |

UNISEX WRAP BACK TIE

| | | |
|---------|---|--------|
| 6130-L | LAB COAT WRAP, WHITE, BACK TIE, UNISEX, LARGE | \$3.99 |
| 6130-M | LAB COAT WRAP, WHITE, BACK TIE, UNISEX, MEDIUM | \$3.99 |
| 6130-XL | LAB COAT WRAP, WHITE, BACK TIE, UNISEX, X-LARGE | \$3.99 |

CLOTH LAB COAT

| | | |
|----------|--|--------|
| LCWXS-P | LAB COAT, WHITE, POLYESTER, SIZE X-SMALL | \$4.00 |
| LCWXXL-C | LAB COAT, WHITE, CLOTH, SIZE XX-LARGE | \$9.99 |
| LCW28-C | LAB COAT, WHITE, CLOTH, SIZE 28 | \$5.99 |
| LCW30-C | LAB COAT, WHITE, CLOTH, SIZE 30 | \$5.99 |
| LCW32-C | LAB COAT, WHITE, CLOTH, SIZE 32 | \$5.99 |

WARM-UP COVER COAT

| | | |
|------|--------------------------|--------|
| CCWS | COVER COAT, WHITE, SMALL | \$5.99 |
|------|--------------------------|--------|

CLOSEOUT Labcoats not included in 99¢ Scrubs special

13822 WEST BOULTON BLVD. METTAWA, IL 60045

WWW.SHOPMEDVET.COM

Phone 800-544-7521

190

Fax 800-204-2177

COATS

MED-VET'S

SCRUBS DEPOT**CLOSEOUT LIMITED SUPPLY****MEDIUM LENGTH LAB COAT**

Stitched down back belt. One inside pocket. Side slits for hand access Pencil pocket within breast pocket. Back vent. 65% poly 35% cotton twill with Visa® soil release. Available in white.

| | | |
|--------|------------------------------------|--------|
| MLC40 | LAB COAT, MED LENGTH, SZ 40, WHITE | \$9.99 |
| MLC42 | LAB COAT, MED LENGTH, SZ 42, WHITE | \$9.99 |
| MLC42T | LAB COAT, MED TALL, SZ 42T, WHITE | \$9.99 |
| MLC44 | LAB COAT, MED LENGTH, SZ 44, WHITE | \$9.99 |
| MLC46 | LAB COAT, MED LENGTH, SZ 46, WHITE | \$9.99 |
| MLC52 | LAB COAT, MED LENGTH, SZ 52, WHITE | \$9.99 |
| MLC54 | LAB COAT, MED LENGTH, SZ 54, WHITE | \$9.99 |
| MLC56 | LAB COAT, MED LENGTH, SZ 56, WHITE | \$9.99 |

CLASSIC LONG LAB COAT

Knee length. Loose two-piece back belt. Side slits for hand access. One inside pocket. Pencil pocket within breast pocket. Back vent. 65% poly 35% cotton twill with Visa® soil release. Available in white.

| | | |
|--------|---------------------------------------|---------|
| CLC38 | LAB COAT, CLASSIC, SZ 38, WHITE, EACH | \$9.99 |
| CLC40 | LAB COAT, CLASSIC, SZ 40, WHITE, EACH | \$9.99 |
| CLC40T | LAB COAT, CLASSIC TALL, SZ 40T, WHITE | \$9.99 |
| CLC42 | LAB COAT, CLASSIC, SZ 42, WHITE, EACH | \$10.99 |
| CLC44 | LAB COAT, CLASSIC, SZ 44, WHITE, EACH | \$9.99 |
| CLC46 | LAB COAT, CLASSIC, SZ 46, WHITE, EACH | \$9.99 |

LAB COAT POLYESTER

| | | |
|--------|---------------------------------------|--------|
| LCBS-P | LAB COAT, BLUE, POLYESTER, SIZE SMALL | \$5.99 |
| LCWM-P | LAB COAT, WHITE, POLY, MEDIUM | \$5.99 |

STAFF LENGTH LAB COAT

| | | |
|--------|--|--------|
| 7139L | LAB COAT, WHITE, STAFF LENGTH, UNISEX, LARGE | \$9.99 |
| 7139XL | LAB COAT, WHITE, STAFF LENGTH, UNISEX, X-LARGE | \$9.99 |

KNEE LENGTH LAB COAT

| | | |
|---------|---|---------|
| 418-M | LAB COAT, WHITE, KNEE LENGTH, UNISEX, SNAPS, MEDIUM | \$10.99 |
| 418-XXL | LAB COAT, WHITE, KNEE LENGTH, UNISEX, SNAPS, XX-LARGE | \$13.99 |

FULL LENGTH LAB COAT

| | | |
|----------|---|---------|
| 7143XXXL | LAB COAT, WHITE, FULL LENGTH, UNISEX, XXX-LARGE | \$12.99 |
| 7143XXL | LAB COAT, WHITE, FULL LENGTH, UNISEX, XX-LARGE | \$12.99 |

CLOSEOUT Labcoats not included in 95' Scrubs special

LAB COAT SURPLUS BLOWOUT

Unisex Staff Length Lab Coat

Women's Lab Coat 80% polyester/20% cotton poplin. White button front lab coat with two lower pockets, one check pocket. Staff length.

ONLY TWO SIZES LEFT!

MDT12WHT42E Size 42, White, Staff Length \$17.18/ea

MDT12WHT44E Size 44, White, Staff Length \$9.99/ea

WHILE QUANTITIES LAST!!!



Safety Goggles & Surgical Masks



See Our Surgical Section

13822 WEST BOULTON BLVD. METTAWA, IL 60045

WWW.SHOPMEDVET.COM

Phone 800-544-7521

191

Fax 800-204-2177

SHIRTS

MED-VET'S

SCRUBS DEPOT

CLOSEOUT LIMITED SUPPLY

(1) 95¢ CLOSEOUT Scrub with every \$10 purchase While Supplies Last!

X-SMALL

| | | |
|-----------|---|--------|
| 2982-131 | SHIRT, JADE GREEN, REVERSIBLE, KAUMOGRAPHED, XSMALL | \$0.99 |
| SCBXS | SHIRT, CIEL BLUE, X-SMALL | \$0.99 |
| SJGXS | SHIRT, JADE GREEN, X-SMALL | \$0.99 |
| SMGXS | SHIRT, MISTY GREEN, X-SMALL | \$0.99 |
| SWXS-KAUM | SHIRT, WHITE, KAUM, X-SMALL | \$0.99 |
| SNXS | SHIRT, NAVY, X-SMALL | \$0.99 |
| SMGXS-CAP | SHIRT, MISTY GREEN, CAP SLEEVE, X-SML | \$0.99 |

SMALL

| | | |
|------------|--|--------|
| STS | SHIRT, TEAL, SMALL | \$0.99 |
| 46856-1P3 | SHIRT, PURPLE, VNECK, UNISEX, SMALL | \$0.99 |
| 46875-2L3 | SHIRT, TEAL, VNECK, UNISEX, SMALL | \$0.99 |
| HX3402-RG3 | SHIRT, JADE GREEN, KAUMOGRAPHED, UNISEX, SMALL | \$0.99 |
| HX3620-213 | SHIRT, CIEL, UNISEX, REVERSIBLE, SMALL | \$0.99 |
| SCS | SHIRT, CRANBERRY, SMALL | \$0.99 |
| SGS | SHIRT, GRAY, SMALL | \$0.99 |
| SJGS | SHIRT, JADE GREEN, SMALL | \$0.99 |
| SMGS | SHIRT, MISTY GREEN, SMALL | \$0.99 |
| SMGS-CAP | SHIRT, MISTY GREEN, CAP SLEEVE, SMALL | \$0.99 |
| SSS | SHIRT, SHAPPIRE, SMALL | \$0.99 |
| T-SBLKS | T-SHIRT, BLACK, UNISEX, SMALL | \$0.99 |

MEDIUM

| | | |
|------------|--|--------|
| HX3620-215 | SHIRT, CIEL, UNISEX, REVERSIBLE, MEDIUM | \$0.99 |
| 46876-8H5 | SHIRT, HUNTER GREEN, VNECK, UNISEX, MEDIUM | \$0.99 |
| HX3402-RG5 | SHIRT, GREEN, KAUMOGRAPHED, UNISEX, MEDIUM | \$0.99 |
| 46875-225 | SHIRT, MISTY, VNECK, UNISEX, MEDIUM | \$0.99 |
| SBLM | SHIRT, BLACK, MEDIUM | \$0.99 |
| SWM | SHIRT, WHITE, MEDIUM | \$0.99 |

LARGE

| | | |
|-----------|-----------------------------------|--------|
| 46875-2L7 | SHIRT, TEAL, VNECK, UNISEX, LARGE | \$0.99 |
| SMBL-AS | SHIRT, MARINE BLUE | \$0.99 |
| SWL | SHIRT, WHITE | \$0.99 |

LARGE

| | | |
|------------|--|--------|
| SCBL-POLO | SHIRT, CIEL BLUE, POLO | \$0.99 |
| SRL-POLO | SHIRT, RED, POLO | \$0.99 |
| HX3402-RG7 | SHIRT, JADE GREEN, KAUMOGRAPHED, UNISEX, LARGE | \$0.99 |

X-LARGE

| | | |
|------------|--|--------|
| SCXL-POLO | SHIRT, CRANBERRY, X-LARGE, POLO | \$0.99 |
| SMGXL-CAP | SHIRT, MISTY GREEN, CAP SLEEVE, XL | \$0.99 |
| SWXL | SHIRT, WHITE, X-LARGE | \$0.99 |
| 46876-8N9 | SHIRT, BLUENAVY, VNECK, UNISEX, X-LARGE | \$0.99 |
| ET0010-1H9 | SHIRT, SHERWOOD, VNECK, UNISEX, X-LARGE | \$0.99 |
| HX3402-RG9 | SHIRT, JADE GREEN, KAUMOGRAPHED, UNISEX, X-LARGE | \$0.99 |
| 46875-229 | SHIRT, MISTY, VNECK, UNISEX, X-LARGE | \$0.99 |
| 46875-223 | SHIRT, MISTY, VNECK, UNISEX, SMALL | \$0.99 |

XX-LARGE

| | | |
|------------|---------------------------------------|--------|
| 46875-222X | SHIRT, MISTY, VNECK, UNISEX, XX-LARGE | \$0.99 |
|------------|---------------------------------------|--------|

XXX-LARGE

| | | |
|------------|---|--------|
| SMGXXXL | SHIRT, MISTY GREEN, XXXL | \$0.99 |
| 226794-3XL | SHIRT, JADE GREEN, VNECK, UNISEX, XXX-LARGE | \$0.99 |
| 46856-2L4X | SHIRT, TEAL, VNECK, UNISEX, XXX-LARGE | \$0.99 |

XXXX-LARGE

| | | |
|--------------|---|--------|
| 2982-135X | SHIRT, JADE GREEN, REVERSIBLE, KAUMOGRAPHED, XXXX-LARGE | \$0.99 |
| 46873-225X | SHIRT, MISTY, UNISEX, XXXX-LARGE | \$0.99 |
| F-46856-2L4X | SHIRT, TEAL, VNECK, UNISEX, XXX-LARGE, FREE | \$0.00 |

HURRY THESE ARE SELLING OUT FAST!

When they're gone they're gone!

CLOSEOUT Labcoats not included in 95¢ Scrubs special

13822 WEST BOULTON BLVD. METTAWA, IL 60045

WWW.SHOPMEDVET.COM

Phone 800-544-7521

192

Fax 800-204-2177

PANTS**MED-VET'S**

SCRUBS DEPOT

CLOSEOUT LIMITED SUPPLY

(1) 95¢ CLOSEOUT Scrub with every \$10 purchase While Supplies Last!

X-SMALL

| | | |
|-----------|---|--------|
| 2983-131 | PANTS, JADE GREEN, REVERSIBLE, KAUMOGRAPHED, X-SMALL | \$0.99 |
| 46585-1R1 | PANTS, ORCHID, W/POCKETS, WOMEN'S, X-SMALL | \$0.99 |
| 46585-1T1 | PANTS, TIFFANY TURQUOISE, W/POCKETS, WOMEN'S, X-SMALL | \$0.99 |
| PJGXS-EW | PANTS, JADE GREEN, ELASTIC WAIST, X-SMALL | \$0.99 |
| PCBXS-AS | PANTS, CIEL BLUE, X-S, ATHLETIC STYLE | \$0.99 |
| PMGXS | PANTS, MISTY GREEN, XS | \$0.99 |
| PMGXS-EW | PANTS, MISTY GREEN, ELASTIC WAIST, XS | \$0.99 |
| PTRXS-EW | PANTS, TEA ROSE, ELASTIC WAIST, X-SM | \$0.99 |

SMALL

| | | |
|------------|---|--------|
| 46598-143 | PANTS, WILD PLUM, TAILORED, WOMEN'S, SMALL | \$0.99 |
| 46598-1N3 | PANTS, NAVY, TAILORED, WOMEN'S, SMALL | \$0.99 |
| 46817-123 | PANTS, MISTY GREEN, ELASTIC WAIST, WOMEN'S, SMALL | \$0.99 |
| 46860-103 | PANTS, WHITE, TAILORED, WOMEN'S, SMALL | \$0.99 |
| 46878-203 | PANTS, WHITE, DRAWSTRING, UNISEX, SMALL | \$0.99 |
| HX3403-RG3 | PANTS, JADE GREEN, KAUMOGRAPHED, UNISEX, SMALL | \$0.99 |
| N46877-123 | PANTS, MISTY GREEN, ELASTIC WAIST, WOMEN'S, SMALL | \$0.99 |
| PMGS | PANTS, MISTY GREEN, SMALL | \$0.99 |
| PPCS | PANTS, PEACOCK, SMALL | \$0.99 |

MEDIUM

| | | |
|------------|--|--------|
| 46817-125 | PANTS, MISTY GREEN, ELASTIC WAIST, WOMEN'S, MEDIUM | \$0.99 |
| 46837-SG5 | PANTS, SILVER GRAY, ELASTIC WAIST, WOMEN'S, MEDIUM | \$0.99 |
| 46857-235 | PANTS, JADE, ELASTIC WAIST, WOMEN'S, MEDIUM | \$0.99 |
| 46878-8H5 | PANTS, HUNTER GREEN, DRAWSTRING, UNISEX, MEDIUM | \$3.99 |
| PMGM | PANTS, MISTY GREEN, MEDIUM | \$0.99 |
| PMGM-EW | PANTS, MISTY GREEN, MED, ELASTIC WAIST | \$0.99 |
| 46597-1S5 | PANTS, SOUTH SEA GREEN, W/POCKETS, WOMEN'S, MEDIUM | \$0.99 |
| 46888-1G5 | PANTS, ASH GRAY, DRAWSTRING, UNISEX, MEDIUM | \$0.99 |
| ET0048-R15 | PANTS, CIEL BLUE, REVERSIBLE, DRAWSTRING, MEDIUM | \$0.99 |

MEDIUM

| | | |
|--------------|---|--------|
| N46877-125 | PANTS, MISTY GREEN, ELASTIC WAIST, WOMEN'S, MEDIUM | \$0.99 |
| 46888-155 | PANTS, KHAKI, DRAWSTRING, UNISEX, MEDIUM | \$0.99 |
| E/6873-32M | PANTS, MISTY, DRAWSTRING W/CUFFS, UNISEX, MEDIUM | \$0.99 |
| HX3383-1L5 | PANTS, TEAL, UNISEX, MEDIUM | \$0.99 |
| HX3403-RG5 | PANTS, JADE GREEN, KAUMOGRAPHED, UNISEX, MEDIUM | \$0.99 |
| PMGM-KAUM | PANTS, MISTY GREEN, KAUM, MEDIUM | \$0.99 |
| 46599-1B5 | PANTS, BORDEAUX, ELASTIC WAIST, WOMEN'S, MEDIUM | \$0.99 |
| 46878-115 | PANTS, CIEL BLUE, DRAWSTRING, UNISEX, MEDIUM | \$0.99 |
| 46597-115 | PANTS, CIEL BLUE, W/POCKETS, WOMEN'S, MEDIUM | \$0.99 |
| 46858-IP5 | PANTS, IMPERIAL PURPLE, DRAWSTRING, UNISEX, MEDIUM | \$0.99 |
| 12004-1200-M | PANTS, OLIVE GREEN, ELASTIC WAIST, WOMEN'S, MEDIUM | \$0.99 |
| 12003-1200-M | PANTS, OLIVE GREEN, EW, CARGO POCKET, WOMEN'S, MEDIUM | \$0.99 |
| 46889-1L5 | PANTS, TEAL, ELASTIC WAIST, UNISEX, MEDIUM | \$0.99 |
| 46585-1L5 | PANTS, TEAL, W/POCKETS, WOMEN'S, MEDIUM | \$0.99 |
| 46878-8H5 | PANTS, HUNTER GREEN, DRAWSTRING, UNISEX, MEDIUM | \$3.99 |

LARGE

| | | |
|------------|---|--------|
| 46585-1P7 | PANTS, FRESH PEACH, W/POCKETS, WOMEN'S, LARGE | \$0.99 |
| 46597-117 | PANTS, CIEL BLUE, W/POCKETS, WOMEN'S, LARGE | \$0.99 |
| 46817-127 | PANTS, MISTY GREEN, ELASTIC WAIST, WOMEN'S, LARGE | \$0.99 |
| 46585-1P7 | PANTS, FRESH PEACH, W/POCKETS, WOMEN'S, LARGE | \$0.99 |
| 46597-117 | PANTS, CIEL BLUE, W/POCKETS, WOMEN'S, LARGE | \$0.99 |
| 46817-127 | PANTS, MISTY GREEN, ELASTIC WAIST, WOMEN'S, LARGE | \$0.99 |
| 46837-SG7 | PANTS, SILVER GRAY, ELASTIC WAIST, WOMEN'S, LARGE | \$0.99 |
| 46860-1L7 | PANTS, TEAL, TAILORED, WOMEN'S, LARGE | \$0.99 |
| 46878-8H7 | PANTS, HUNTER GREEN, DRAWSTRING, UNISEX, LARGE | \$0.99 |
| 46888-157 | PANTS, KHAKI, DRAWSTRING, UNISEX, LARGE | \$0.99 |
| HX3403-RG7 | PANTS, JADE GREEN, KAUMOGRAPHED, UNISEX, LARGE | \$0.99 |
| 46585-1P7 | PANTS, FRESH PEACH, W/POCKETS, WOMEN'S, LARGE | \$0.99 |
| 46597-117 | PANTS, CIEL BLUE, W/POCKETS, WOMEN'S, LARGE | \$0.99 |

Shop online 27 hours a day 7 days a week WWW.SHOPMEDVET.COM

CLOSEOUT Labcoats not included in 95¢ Scrubs special

13822 WEST BOULTON BLVD. METTAWA, IL 60045

WWW.SHOPMEDVET.COM

Phone 800-544-7521

193

Fax 800-204-2177

PANTS

MED-VET'S

SCRUBS DEPOT**CLOSEOUT LIMITED SUPPLY****(1) 95¢ CLOSEOUT Scrub with every \$10 purchase While Supplies Last!****LARGE**

| | | |
|------------|---|--------|
| 46817-127 | PANTS, MISTY GREEN, ELASTIC WAIST, WOMEN'S, LARGE | \$0.99 |
| 46837-SG7 | PANTS, SILVER GRAY, ELASTIC WAIST, WOMEN'S, LARGE | \$0.99 |
| 46860-1L7 | PANTS, TEAL, TAILORED, WOMEN'S, LARGE | \$0.99 |
| HX3403-RG7 | PANTS, JADE GREEN, KAUMOGRAPHED, UNISEX, LARGE | \$0.99 |
| PCBL | PANTS, CIEL BLUE, LARGE | \$0.99 |
| 46860-117 | PANTS, CIEL BLUE, TAILORED, WOMEN'S, LARGE | \$0.99 |
| 46585-3P7 | PANTS, FRESH PEACH, W/D POCKETS, WOMEN'S, LARGE | \$0.99 |

X-LARGE

| | | |
|-------------|---|--------|
| 46585-1C9 | PANTS, CARRIBEAN CORAL, W/D POCKETS, WOMEN'S, X-LARGE | \$0.99 |
| HX3403-RG9 | PANTS, JADE GREEN, KAUMOGRAPHED, UNISEX, X-LARGE | \$0.99 |
| 46817-129 | PANTS, MISTY GREEN, ELASTIC WAIST, WOMEN'S, X-LARGE | \$0.99 |
| PMGXL-KAUM | PANTS, MISTY GREEN, KAUM, X-LARGE | \$0.99 |
| P82500-1HD9 | PANTS, SHERWOOD, UNISEX, X-LARGE | \$0.99 |
| 46872-2L9 | PANTS, TEAL, ELASTIC WAIST, WOMEN'S, X-LARGE | \$0.99 |

XX-LARGE

| | | |
|-------------|--|--------|
| 46872-232X | PANTS, JADE, ELASTIC WAIST, WOMEN'S, XX-LARGE | \$0.99 |
| 46599-112X | PANTS, CIEL BLUE, ELASTIC WAIST, WOMEN'S, XX-LARGE | \$0.99 |
| HX3403-RG2X | PANTS, JADE GREEN, KAUMOGRAPHED, UNISEX, XX-LARGE | \$0.99 |
| HX3383-1L2X | PANTS, TEAL, UNISEX, XX-LARGE | \$0.99 |
| 46857-232X | PANTS, JADE, ELASTIC WAIST, WOMEN'S, XX-LARGE | \$0.99 |

XX-LARGE

| | | |
|-------------|---|--------|
| 46817-122X | PANTS, MISTY GREEN, ELASTIC WAIST, WOMEN'S, XX-LARGE | \$0.99 |
| PMGXXL | PANTS, MISTY GREEN, XXL | \$0.99 |
| 46888-1G3X | PANTS, ASH GRAY, DRAWSTRING, UNISEX, XXX-LARGE | \$0.99 |
| 46857-233X | PANTS, JADE, ELASTIC WAIST, WOMEN'S, XXX-LARGE | \$0.99 |
| 46888-1S3X | PANTS, SOUTH SEA GREEN, DRAWSTRING, UNISEX, XXX-LARGE | \$0.99 |
| 46872-2L3X | PANTS, TEAL, ELASTIC WAIST, WOMEN'S, XXX-LARGE | \$0.99 |
| HX3383-1L3X | PANTS, TEAL, UNISEX, XXX-LARGE | \$0.99 |
| 46860-103X | PANTS, WHITE, TAILORED, WOMEN'S, XXX-LARGE | \$0.99 |
| PCBXXXL | PANTS, CIEL BLUE, XXX-LARGE | \$0.99 |
| PJGXXXL | PANTS, JADE GREEN, XXXL | \$0.99 |
| PMGXXXL | PANTS, MISTY GREEN, XXXL | \$0.99 |

XXXX-LARGE

| | | |
|-------------|---|--------|
| 2983-134X | PANTS, JADE GREEN, REVERSIBLE, KAUMOGRAPHED, XXXX-LARGE | \$0.99 |
| 46594-124X | PANTS, MISTY GREEN, CARGO, WOMEN'S, XXXX-LARGE | \$0.99 |
| 46817-124X | PANTS, MISTY GREEN, ELASTIC WAIST, WOMEN'S, XXXX-LARGE | \$0.99 |
| 2983-135X | PANTS, JADE GREEN, REVERSIBLE, KAUMOGRAPHED, XXXX-LARGE | \$0.99 |
| HX3403-RC5X | PANTS, CIEL, KAUMOGRAPHED, UNISEX, XXXX-LARGE | \$0.99 |
| 46597-105X | PANTS, VN TAGE ROSE, W/POCKETS, WOMEN'S, XXXX-LARGE | \$0.99 |
| 46872-123X | PANTS, MISTY GREEN, ELASTIC WAIST, WOMEN'S, XXX-LARGE | \$0.99 |
| 46817-123X | PANTS, MISTY GREEN, ELASTIC WAIST, WOMEN'S, XXX-LARGE | \$0.99 |

**CLOSEOUT
SYRINGES & NEEDLES**As low as
\$5.00/bx

WHILE SUPPLIES LAST!

**ELASTIC, PLASTIC &
PAPER MEDICAL TAPE**As low as
\$5.00/bx

WHILE SUPPLIES LAST!

**SINGLE SUTURE
UP TO 70% Off**LIMITED SUPPLY CLOSEOUT
Cohesive Tape (Various Brands)

WHILE SUPPLIES LAST!

STOP BY THE CLOSEOUT SECTION ON OUR WEBSITE, AND SAVE YOURSELF SOME MONEY!**WWW.SHOPMEDVET.COM/CLOSEOUT-PRODUCTS**

Images are used for graphic representation only actual product may be different. Please Inquire

CLOSEOUT Labcoats not included in 95¢ Scrubs special

13822 WEST BOULTON BLVD. METTAWA, IL 60045

WWW.SHOPMEDVET.COM

Phone 800-544-7521

194

Fax 800-204-2177

SCRUBS DEPOT

CLOSEOUT LIMITED SUPPLY

(1) 95¢ CLOSEOUT Scrub with every \$10 purchase While Supplies Last!



X-SMALL

| | | |
|------------|--|--------|
| 33082L1 | TUNIC, TEAL, CROSSOVER, REVERSIBLE, X-SMALL | \$0.99 |
| 46576-111 | TUNIC, CIEL BLUE, EASY-OUT, WOMEN'S, X-SMALL | \$0.99 |
| 46576-1B1 | TUNIC, BORDEAUX, EASY-OUT, WOMEN'S, X-SMALL | \$0.99 |
| 46576-1N1 | TUNIC, NAVY, EASY-OUT, WOMEN'S, X-SMALL | \$0.99 |
| 46581-171 | TUNIC, MARINE BLUE, SILHOUETTE, WOMEN'S, X-SMALL | \$0.99 |
| 46581-421 | TUNIC, CELEBRATION WHITE, SILHOUETTE, WOMEN'S, X-SMALL | \$0.99 |
| 46583-1L1 | TUNIC, TEAL, SQUARE NECK, WOMEN'S, X-SMALL | \$0.99 |
| 46583-431 | TUNIC, CELEBRATION PINK, SQUARE NECK, WOMEN'S, X-SMALL | \$0.99 |
| 46586-701 | TUNIC, INCA, PRINCESS TUNIC, WOMEN'S, X-SMALL | \$0.99 |
| 46815-131 | TUNIC, JADE GREEN, UNISEX, X-SMALL | \$0.99 |
| HX3462-2L1 | TUNIC, TEAL, SQUARE NECK, WOMEN'S, X-SMALL | \$0.99 |
| 46576-1L1 | TUNIC, TEAL, EASY-OUT, WOMEN'S, X-SMALL | \$0.99 |
| 46876N-111 | TUNIC, CIEL BLUE, SET-IN SLEEVE, UNISEX, X-SMALL | \$0.99 |

SMALL

| | | |
|------------|---|--------|
| 33082L3 | TUNIC, TEAL, CROSSOVER, REVERSIBLE, SMALL | \$0.99 |
| 46576-113 | TUNIC, CIEL BLUE, EASY-OUT, WOMEN'S, SMALL | \$0.99 |
| 46576-123 | TUNIC, MISTY GREEN, EASY-OUT, WOMEN'S, SMALL | \$0.99 |
| 46576-143 | TUNIC, WILD PLUM, EASY-OUT, WOMEN'S, SMALL | \$0.99 |
| 46576-1B3 | TUNIC, BORDEAUX, EASY-OUT, WOMEN'S, SMALL | \$0.99 |
| 46576-1L3 | TUNIC, TEAL, EASY-OUT, WOMEN'S, SMALL | \$0.99 |
| 46583-523 | TUNIC, ARIEL GREEN, SQUARE NECK, WOMEN'S, SMALL | \$0.99 |
| 46586-433 | TUNIC, CELEBRATION PINK, PRINCESS TUNIC, WOMEN'S, SMALL | \$0.99 |
| 46587-0101 | TUNIC, TEAL, SNAP FRONT, WOMEN'S, SMALL | \$0.99 |
| 46835-DR3 | TUNIC, DUSTY ROSE, UNISEX, SMALL | \$0.99 |
| 46836-PL3 | TUNIC, PLUM, PRINCESS TUNIC, WOMEN'S, SMALL | \$0.99 |
| 46870-233 | TUNIC, JADE, CROSSOVER, UNISEX, SMALL | \$0.99 |
| 46870-2L3 | TUNIC, TEAL, CROSSOVER, UNISEX, SMALL | \$0.99 |
| 46885-1G3 | TUNIC, ASH GRAY, VNECK, UNISEX, SMALL | \$0.99 |
| HX3462-2L3 | TUNIC, TEAL, SQUARE NECK, WOMEN'S, SMALL | \$0.99 |
| 46576-433 | TUNIC, CELEBRATION PINK, EASY-OUT, WOMEN'S, SMALL | \$0.99 |
| TTPS | TUNIC, TEAL PRINT, SMALL | \$0.99 |
| TTOYS | TUNIC, TOY STORE PRINT, SMALL | \$0.99 |
| TCBS | TUNIC, CIEL BLUE, SMALL | \$0.99 |

SMALL

| | | |
|---------|--------------------------------------|--------|
| TGPGSGS | TUNIC, GRAPE WISEA GREEN, SMALL | \$0.99 |
| THGRBS | TUNIC, HUNTER GREEN W/ROYAL BLUE, SM | \$0.99 |
| THSS | TUNIC, HUNTER SPLASH, SMALL | \$0.99 |
| TJGS | TUNIC, JADE GREEN, SMALL | \$0.99 |
| TMGS | TUNIC, MISTY GREEN, SMALL | \$0.99 |
| TNS | TUNIC, NAVY, SMALL | \$0.99 |

MEDIUM

| | | |
|----------------|---|--------|
| 46576-115 | TUNIC, CIEL BLUE, EASY-OUT, WOMEN'S, MEDIUM | \$0.99 |
| 46576-125 | TUNIC, MISTY GREEN, EASY-OUT, WOMEN'S, MEDIUM | \$0.99 |
| 46576-1B5 | TUNIC, BORDEAUX, EASY-OUT, WOMEN'S, MEDIUM | \$0.99 |
| 46576-1N5 | TUNIC, NAVY, EASY-OUT, WOMEN'S, MEDIUM | \$0.99 |
| 46583-1L5 | TUNIC, TEAL, SQUARE NECK, WOMEN'S, MEDIUM | \$0.99 |
| 46583-525 | TUNIC, ARIEL GREEN, SQUARE NECK, WOMEN'S, MEDIUM | \$0.99 |
| 46583-CB5 | TUNIC, CELEBRATION BLUE, SQUARE NECK, WOMEN'S, MEDIUM | \$0.99 |
| 46584-145 | TUNIC, WILD PLUM, SLOPOVER, WOMEN'S, MEDIUM | \$0.99 |
| 46584-715 | TUNIC, KOALAVILLE, SUPOVER, WOMEN'S, MEDIUM | \$0.99 |
| 46586-745 | TUNIC, PRINCESS TUNIC, WOMEN'S, MEDIUM | \$0.99 |
| 46587-0102 | TUNIC, TEAL, SNAP FRONT, WOMEN'S, MEDIUM | \$0.99 |
| 46587-1S5 | TUNIC, SOUTH SEA GREEN, SNAP V, WOMEN'S, MEDIUM | \$0.99 |
| 46587-785 | TUNIC, VINTAGE FLORAL, SNAP V, WOMEN'S, MEDIUM | \$0.99 |
| 46812-135 | TUNIC, JADE, CROSSOVER, UNISEX, MEDIUM | \$0.99 |
| 46830-SG5 | TUNIC, SILVER GRAY, VNECK, WOMEN'S, MEDIUM | \$0.99 |
| 46851-1P5 | TUNIC, PURPLE, CROSSOVER, WOMEN'S, MEDIUM | \$0.99 |
| HX3462-2L5 | TUNIC, TEAL, SQUARE NECK, WOMEN'S, MEDIUM | \$0.99 |
| X1706-01CBM-MD | TUNIC, CIEL BLUE, SNAP FRONT, WOMEN'S, MEDIUM | \$0.99 |
| TCBM | TUNIC, CIEL BLUE, MEDIUM | \$0.99 |
| TRGPM | TUNIC, ROYAL/GRAY PRINT, MEDIUM | \$0.99 |
| 46576-145 | TUNIC, WILD PLUM, EASY-OUT, WOMEN'S, MEDIUM | \$0.99 |

LARGE

| | | |
|-----------|---|--------|
| 46576-1B7 | TUNIC, BORDEAUX, EASY-OUT, WOMEN'S, LARGE | \$0.99 |
| 46576-1L7 | TUNIC, TEAL, EASY-OUT, WOMEN'S, LARGE | \$0.99 |
| 46576-1N7 | TUNIC, NAVY, EASY-OUT, WOMEN'S, LARGE | \$0.99 |

CLOSEOUT Labcoats not included in 95¢ Scrubs special

13822 WEST BOULTON BLVD. METTAWA, IL 60045

WWW.SHOPMEDVET.COM

Phone 800-544-7521

195

Fax 800-204-2177

CLOSEOUT LIMITED SUPPLY**(1) 95° CLOSEOUT Scrub with every \$10 purchase While Supplies Last!****LARGE**

| | | |
|-----------|---|--------|
| 46582-537 | TUNIC, ARIEL PINK, SIDE TIE, WOMEN'S, LARGE | \$0.99 |
| 46583-1H7 | TUNIC, SHERWOOD, SQUARE NECK, WOMEN'S, LARGE | \$0.99 |
| 46583-527 | TUNIC, ARIEL GREEN, SQUARE NECK, WOMEN'S, LARGE | \$0.99 |
| 46851-1P7 | TUNIC, PURPLE, CROSSOVER, WOMEN'S, LARGE | \$0.99 |
| 46576-117 | TUNIC, CIEL BLUE, EASY-OUT, WOMEN'S, LARGE | \$0.99 |
| 46576-1S7 | TUNIC, SOUTH SEA GREEN, EASY-OUT, WOMEN'S, LARGE | \$0.99 |
| 46576-437 | TUNIC, CELEBRATION PINK, EASY-OUT, WOMEN'S, LARGE | \$0.99 |
| TRGPL-AS | TUNIC, ROYAL/GRAY PRT,ATH.STYLE,LAR | \$0.99 |
| 46586-437 | TUNIC, CELEBRATION PINK, PRINCESS TUNIC, WOMEN'S, LARGE | \$0.99 |

X-LARGE

| | | |
|----------------|--|--------|
| TRGPRXL-AS | TUNIC, ROYAL/GRAY PRT,ATH.STYLE,XL | \$0.99 |
| 46576-119 | TUNIC, CIEL BLUE, EASY-OUT, WOMEN'S, X-LARGE | \$0.99 |
| 46576-1B9 | TUNIC, BORDEAUX, EASY-OUT, WOMEN'S, X-LARGE | \$0.99 |
| 46576-1L9 | TUNIC, TEAL, EASY-OUT, WOMEN'S, X-LARGE | \$0.99 |
| 46576-1N9 | TUNIC, NAVY, EASY-OUT, WOMEN'S, X-LARGE | \$0.99 |
| 46583-529 | TUNIC, ARIEL GREEN, SQUARE NECK, WOMEN'S, X-LARGE | \$0.99 |
| 46584-1R9 | TUNIC, ORCHID, SLOVER, WOMEN'S, X-LARGE | \$0.99 |
| 46584-1S9 | TUNIC, SOUTH SEA GREEN, SLOVER, WOMEN'S, X-LARGE | \$0.99 |
| 46587-0104 | TUNIC, TEAL, SNAP FRONT, WOMEN'S, X-LARGE | \$0.99 |
| 46587-529 | TUNIC, ARIEL GREEN, SNAP 'X' WOMEN'S, X-LARGE | \$0.99 |
| 46835-DR9 | TUNIC, DUSTY ROSE, UNISEX, X-LARGE | \$0.99 |
| 46852-RB9 | TUNIC, REGATA BLUE, KANGAROO, WOMEN'S, X-LARGE | \$0.99 |
| HX3462-2L9 | TUNIC, TEAL, SQUARE NECK, WOMEN'S, X-LARGE | \$0.99 |
| HX3384-1B9 | TUNIC, BORDEAUX, UNISEX, X-LARGE | \$0.99 |
| X1706-01CBM-XL | TUNIC, CIEL BLUE, SNAP FRONT, WOMEN'S, X-LARGE | \$0.99 |
| 46583-CB9 | TUNIC, CELEBRATION BLUE, SQUARE NECK, WOMEN'S, X-LARGE | \$0.99 |

XX-LARGE

| | | |
|----------|--|--------|
| 33082L2X | TUNIC, TEAL, CROSSOVER, REVERSIBLE, XX-LARGE | \$0.99 |
| 33082L2X | TUNIC, TEAL, CROSSOVER, REVERSIBLE, XX-LARGE | \$0.99 |
| 33082L2X | TUNIC, TEAL, CROSSOVER, REVERSIBLE, XX-LARGE | \$0.99 |

XX-LARGE

| | | |
|-------------|--|--------|
| 46576-112X | TUNIC, CIEL BLUE, EASY-OUT, WOMEN'S, XX-LARGE | \$0.99 |
| 46576-1B2X | TUNIC, BORDEAUX, EASY-OUT, WOMEN'S, XX-LARGE | \$0.99 |
| 46576-CB2X | TUNIC, CELEBRATION BLUE, EASY-OUT, WOMEN'S, XX-LARGE | \$0.99 |
| 46584-432X | TUNIC, CELEBRATION PINK, SLOVER, WOMEN'S, XX-LARGE | \$0.99 |
| 46586-432X | TUNIC, CELEBRATION PINK, PRINCESS TUNIC, WOMEN'S, XX-LARGE | \$0.99 |
| 46587-522X | TUNIC, ARIEL GREEN, SNAP 'X' WOMEN'S, XX-LARGE | \$0.99 |
| 46587-HC2X | TUNIC, HOUSE CALL PRINT, SNAP 'X' WOMEN'S, XX-LARGE | \$0.99 |
| 46870-232X | TUNIC, JADE, CROSSOVER, UNISEX, XX-LARGE | \$0.99 |
| 46873-232X | TUNIC, JADE, CAPSLEEVE, UNISEX, XX-LARGE | \$0.99 |
| HX3384-1B2X | TUNIC, BORDEAUX, UNISEX, XX-LARGE | \$0.99 |
| HX3462-2L2X | TUNIC, TEAL, SQUARE NECK, WOMEN'S, XX-LARGE | \$0.99 |
| TSGXXL | TUNIC, SEA GREEN, XX-LARGE | \$0.99 |
| TTRXXL | TUNIC, TEA ROSE, XX-LARGE | \$0.99 |
| TTXXL-AS | TUNIC, TEAL, ATHLETIC STYLE, XX-LARGE | \$0.99 |
| HX3450-1N2X | TUNIC, NAVY, UNISEX, XX-LARGE | \$0.99 |
| 46886-172X | TUNIC, MARINE BLUE, BASEBALL, UNISEX, XX-LARGE | \$0.99 |
| TCBXXL-SF | TUNIC, CIEL BLUE, SNAP FRONT, XX-LARGE | \$0.99 |
| TSGXXL | TUNIC, SEA GREEN, XX-LARGE | \$0.99 |
| TTRXXL | TUNIC, TEA ROSE, XX-LARGE | \$0.99 |
| TTXXL-AS | TUNIC, TEAL, ATHLETIC STYLE, XX-LARGE | \$0.99 |

XXX-LARGE

| | | |
|-------------|---|--------|
| 33082L3X | TUNIC, TEAL, CROSSOVER, REVERSIBLE, XXX-LARGE | \$0.99 |
| 46583-143X | TUNIC, WILD PLUM, SQUARE NECK, WOMEN'S, XXX-LARGE | \$0.99 |
| 46586-433X | TUNIC, CELEBRATION PINK, PRINCESS TUNIC, WOMEN'S, XXX-LARGE | \$0.99 |
| 46586-783X | TUNIC, VINTAGE FLORAL, PRINCESS TUNIC, WOMEN'S, XXX-LARGE | \$0.99 |
| 46587-0106 | TUNIC, TEAL, SNAP FRONT, WOMEN'S, XXX-LARGE | \$0.99 |
| 46587-513X | TUNIC, ARIEL TEAL, SNAP 'X' WOMEN'S, XXX-LARGE | \$0.99 |
| 46870-2L3X | TUNIC, TEAL, CROSSOVER, UNISEX, XXX-LARGE | \$0.99 |
| 46870-2N3X | TUNIC, NAVY, CROSSOVER, UNISEX, XXX-LARGE | \$0.99 |
| ET0019-SP3X | TUNIC, SEA SPRAY, UNISEX, XXX-LARGE | \$0.99 |
| HX3462-2L3X | TUNIC, TEAL, SQUARE NECK, WOMEN'S, XXX-LARGE | \$0.99 |
| TOBSGXXXL | TUNIC, OCEAN BLUE W/SEA GREEN,XXXL | \$0.99 |

CLOSEOUT Labcoats not included in 95° Scrubs special

13822 WEST BOULTON BLVD. METTAWA, IL 60045

WWW.SHOPMEDVET.COM

Phone 800-544-7521

196

Fax 800-204-2177

WARM-UPS**MED-VET'S****SCRUBS DEPOT****CLOSEOUT LIMITED SUPPLY****(1) 95¢ CLOSEOUT Scrub with every \$10 purchase While Supplies Last!****X-SMALL**

| | | |
|-----------|--|--------|
| 46589-141 | WARM-UP, PLUM, TRADITIONAL, WOMEN'S, X-SMALL | \$0.99 |
| 46589-431 | WARM-UP, CELEBRATION PINK, TRADITIONAL, WOMEN'S, X-SMALL | \$0.99 |
| 46590-171 | WARM-UP, MARINE BLUE, COMFORT PLUS, WOMEN'S, X-SMALL | \$0.99 |
| 46589-1A1 | WARM-UP, AZALEA PINK, TRADITIONAL, WOMEN'S, X-SMALL | \$0.99 |
| 46589-661 | WARM-UP, PERFECT PANSY, TRADITIONAL, WOMEN'S, X-SMALL | \$0.99 |
| 46859-FF1 | WARM-UP, FALL FOLIAGE, UNISEX, X-SMALL | \$0.99 |
| 46590-161 | WARM-UP, PARFAIT PINK, COMFORT PLUS, WOMEN'S, X-SMALL | \$0.99 |

SMALL

| | | |
|-----------|---|--------|
| 46593-173 | WARM-UP, MARINE BLUE, STAND UP COLLAR, WOMEN'S, SMALL | \$0.99 |
| 46819-123 | WARM-UP, MISTY UNISEX, SMALL | \$0.99 |
| 46859-FF3 | WARM-UP, FALL FOLIAGE, UNISEX, SMALL | \$0.99 |
| WUMGS | WARM-UP, MISTY GREEN, SMALL | \$0.99 |
| 46593-703 | WARM-UP, INCA, STAND UP COLLAR, WOMEN'S, SMALL | \$0.99 |
| 46864-133 | WARM-UP, GREEN, CVR/COAT, UNISEX, SMALL | \$0.99 |
| 46593-1H3 | WARM-UP, SHERWOOD, STAND UP COLLAR, WOMEN'S, SMALL | \$0.99 |
| 46880-1B3 | WARM-UP, BORDEAUX, TRADITIONAL, WOMEN'S, SMALL | \$0.99 |
| 46589-1T3 | WARM-UP, TIFFANY TURQUOISE, TRADITIONAL, WOMEN'S, SMALL | \$0.99 |
| WUTOYS | WARM-UP, TOY STORE PRINT, SMALL | \$0.99 |

MEDIUM

| | | |
|------------|--|--------|
| 46589-0194 | WARM-UP, TEAL, TRADITIONAL, WOMEN'S, MEDIUM | \$0.99 |
| 46593-175 | WARM-UP, MARINE BLUE, STAND UP COLLAR, WOMEN'S, MEDIUM | \$0.99 |
| 46593-1L5 | WARM-UP, TEAL, STAND UP COLLAR, WOMEN'S, MEDIUM | \$0.99 |
| 46593-705 | WARM-UP, INCA, STAND UP COLLAR, WOMEN'S, MEDIUM | \$0.99 |
| 46880-1B5 | WARM-UP, BORDEAUX, TRADITIONAL, WOMEN'S, MEDIUM | \$0.99 |
| 46589-1G5 | WARM-UP, ASH GRAY, TRADITIONAL, WOMEN'S, MEDIUM | \$0.99 |
| 46589-525 | WARM-UP, ARIEL GREEN, TRADITIONAL, WOMEN'S, MEDIUM | \$0.99 |

LARGE

| | | |
|------------|--|--------|
| 46589-0195 | WARM-UP, TEAL, TRADITIONAL, WOMEN'S, LARGE | \$0.99 |
|------------|--|--------|

LARGE

| | | |
|-----------|---|--------|
| 46589-527 | WARM-UP, ARIEL GREEN, TRADITIONAL, WOMEN'S, LARGE | \$0.99 |
| 46593-177 | WARM-UP, MARINE BLUE, STAND UP COLLAR, WOMEN'S, LARGE | \$0.99 |
| 46819-127 | WARM-UP, MISTY UNISEX, LARGE | \$0.99 |
| 46839-PL7 | WARM-UP, PLUM, TRADITIONAL, WOMEN'S, LARGE | \$0.99 |
| 46880-137 | WARM-UP, JADE GREEN, TRADITIONAL, WOMEN'S, LARGE | \$0.99 |
| WUEGL | WARM-UP, EMERALD GREEN, LARGE | \$0.99 |
| 46880-1B7 | WARM-UP, BORDEAUX, TRADITIONAL, WOMEN'S, LARGE | \$0.99 |
| 3270-137 | WARM-UP, JADE GREEN, KAUM OHIO HEALTH, LARGE | \$0.99 |
| 46589-1C7 | WARM-UP, CARRIBEAN CORAL, TRADITIONAL, WOMEN'S, LARGE | \$0.99 |

X-LARGE

| | | |
|------------|--|--------|
| 46589-0196 | WARM-UP, TEAL, TRADITIONAL, WOMEN'S, X-LARGE | \$0.99 |
| 46880-149 | WARM-UP, WILD PLUM, TRADITIONAL, WOMEN'S, X-LARGE | \$0.99 |
| WUEGXL | WARM-UP, EMERALD GREEN, X-LARGE | \$0.99 |
| 46590-169 | WARM-UP, PARFAIT PINK, COMFORT PLUS, WOMEN'S, X-LARGE | \$0.99 |
| 46864-1L9 | WARM-UP, TEAL, CVR/COAT, UNISEX, X-LARGE | \$0.99 |
| 46589-789 | WARM-UP, VINTAGE FLORAL, TRADITIONAL, WOMEN'S, X-LARGE | \$0.99 |
| 46864-139 | WARM-UP, GREEN, CVR/COAT, UNISEX, X-LARGE | \$0.99 |
| 46593-1L9 | WARM-UP, TEAL, STAND UP COLLAR, WOMEN'S, X-LARGE | \$0.99 |

XX-LARGE

| | | |
|------------|--|--------|
| 46589-0197 | WARM-UP, TEAL, TRADITIONAL, WOMEN'S, XX-LARGE | \$0.99 |
| 46589-142X | WARM-UP, PLUM, TRADITIONAL, WOMEN'S, XX-LARGE | \$0.99 |
| 46819-122X | WARM-UP, MISTY UNISEX, XX-LARGE | \$0.99 |
| 46879-212X | WARM-UP, CEIL BLUE, UNISEX, XX-LARGE | \$0.99 |
| 46839-PL2X | WARM-UP, PLUM, TRADITIONAL, WOMEN'S, XX-LARGE | \$0.99 |
| 46589-522X | WARM-UP, ARIEL GREEN, TRADITIONAL, WOMEN'S, XX-LARGE | \$0.99 |

XXX-LARGE

| | | |
|------------|--|--------|
| 46819-123X | WARM-UP, MISTY UNISEX, XXX-LARGE | \$0.99 |
| 46589-0198 | WARM-UP, TEAL, TRADITIONAL, WOMEN'S, XXX-LARGE | \$0.99 |

CLOSEOUT Labcoats not included in 95¢ Scrubs special

13822 WEST BOULTON BLVD. METTAWA, IL 60045

WWW.SHOPMEDVET.COM

Phone 800-544-7521

197

Fax 800-204-2177

Vials & Containers

Ovals, Prescription Vials, Sharps & Dropper Bottles



Amber Plastic Graduated Ovals

Amber Plastic Graduated Ovals with twist off child resistant caps. Lightweight transparent amber ovals graduated in ounces and milliliters.

| | | |
|--------|--------------|------------|
| ONAL2 | 2 oz 200/cs | \$40.00/cs |
| ONAL4 | 4 oz 200/cs | \$46.00/cs |
| ONAL6 | 6 oz 100/cs | \$33.00/cs |
| ONAL8 | 8 oz 100/cs | \$36.00/cs |
| ONAL12 | 12 oz 100/cs | \$41.00/cs |
| ONAL16 | 16 oz 50/cs | \$33.00/cs |



Amber Prescription Safety Cap Vials

High Quality Tight and light resistant amber vials are excellent for dispensing medication. Available in a large variety of sizes. Each case has 100% Child Resistant Caps with 10% Snap Caps.

| | | |
|---------|---|------------|
| VIAL60 | Height 6.6cm (2.6") Diameter 2.55cm (1") 6 Dram, 600/cs | \$42.00/cs |
| VIAL80 | Height 6.6cm (2.6") Diameter 2.55cm (1") 8 Dram, 410/cs | \$32.00/cs |
| VIAL130 | Height 6.4cm (2.5") Diameter 3.1cm (1.22") 13 Dram, 320/cs | \$35.00/cs |
| VIAL160 | Height 7.9cm (3.1") Diameter 3.1cm (1.22") 16 Dram, 270/cs | \$36.00/cs |
| VIAL200 | Height 6.3cm (2.5") Diameter 4.1cm (1.6") top, 3.5cm (1.4") bottom, 20 Dram, 360/cs | \$51.00/cs |
| VIAL300 | Height 9.1cm (3.6") Diameter 4.1cm (1.6") top, 3.5cm (1.4") bottom, 30 Dram, 240/cs | \$42.00/cs |
| VIAL400 | Height 9.5cm (3.7") Diameter 4.6cm (1.8") top, 4.2cm (1.7") bottom, 40 Dram, 180/cs | \$35.00/cs |
| VIAL600 | Height 6.6cm (2.6") Diameter 2.55cm (1") 60 Dram, 115/cs | \$32.00/cs |



Blue Vials (Safety Cap Vials)

| | | |
|-----------|--|------------|
| VIAL60-B | Height 6.2cm (2.44") Diameter 2.2cm (.866") 6 Dram, Blue, 600/cs | \$42.00/cs |
| VIAL80-B | Height 6.25cm Circumference 2cm, 8 Dram, Blue, 410/cs | \$32.00/cs |
| VIAL130-B | Height 6.4cm (2.5") Diameter 3.1cm (1.22") 13 Dram, Blue, 320/cs | \$35.00/cs |
| VIAL160-B | Height 7.9cm (3.1") Diameter 3.1cm (1.22") 16 Dram, Blue, 270/cs | \$36.00/cs |
| VIAL200-B | Height 6.3cm (2.5") Diameter 4.1cm (1.6") top, 3.5cm (1.4") bottom, 20 Dram, Blue, 360/cs | \$51.00/cs |
| VIAL300-B | Height 9.1cm (3.6") Diameter 4.1cm (1.6") top, 3.5cm (1.4") bottom, 30 Dram, Blue, 240/cs | \$42.00/cs |
| VIAL400-B | Height 9.5cm (3.7") Diameter 4.6cm (1.8") top, 4.2cm (1.7") bottom, 40 Dram, Blue, 180/cs | \$35.00/cs |
| VIAL600-B | Height 13.2cm (5.2") Diameter 4.6cm (1.8") top, 4.2cm (1.7") bottom, 60 Dram, Blue, 115/cs | \$32.00/cs |

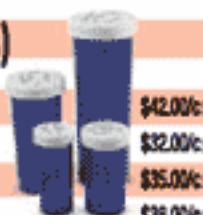

Plastic Gallon Bottle with Screw Top

Plastic Gallon Bottle with Screw Top

140503 1 Gal W/Screw Top

\$179/ea



Spray Bottle

140501 16oz \$1.89/btl
140502 32oz \$1.99/btl



Sharps Containers

For safe disposal of sharps in restricted access areas. Versatile lid accommodates contaminated items of various sizes. Constructed of puncture resistant polypropylene. Locking top flap. Easy to assemble. Meets all EPA and OSHA standards. Nestable containers save space and reduce shipping costs.

| | | |
|-------------|------------|------------|
| SHARP-10 | 1 Quart | \$1.99/ea |
| SHARP-2.5QT | 2.5qt each | \$4.00/ea |
| SHARP-1G | 1 gallon | \$2.50/ea |
| SHARP-2G | 2 gallons | \$3.79/ea |
| SHARP-8G | 8 gallons | \$10.99/ea |
| SHARP-10G | 10 gallons | \$12.99/ea |
| SHARP-16G | 16 gallons | \$29.00/ea |



**Starting At
\$1.99/ea**



Jorvet Sharp's Container

Veterinarians increasingly understand the need to be in compliance with government regulations from agencies like OSHA and the EPA. These regulations require proper disposal of medical waste in containers specifically designed for such use. These red plastic containers are especially designed for easy and proper disposal of items such as hypodermic needles, suture needles, and scalpel blades. The top lid has a special slot that helps removal of hypodermic needles from their hub. When the container is completely full, the lid seals permanently and tightly for proper disposal.

| | | |
|---------|-----------|-----------|
| JOR886 | 4 liter | \$3.30/ea |
| JOR886A | 0.5 Liter | \$2.10/ea |

Jorvet



Amber Dropper Bottle

Plastic amber bottles with dropper caps that can be removed to administer treatment or to allow refilling. Shows ounce and mL markings on bottles and dropper. 12 per box.

| | | |
|------|------------------|------------|
| DB.5 | 1/2 Ounce 12/Box | \$8.95/box |
| DB1 | 1 Ounce 12/Box | \$8.95/box |
| DB2 | 2 Ounce 12/Box | \$8.95/box |



Jorvet Plastic Medicine Dropper

with blue rubber bulb. Graduated in milliliters and teaspoons. 2.5ml (1/2 tsp.) 5/pk. **Jorvet**

| | | |
|---------|-----------------|------------|
| JORR24C | 2 1/2ml, 5 Pack | \$12.00/pk |
|---------|-----------------|------------|



Jorvet Glass Eye Dropper

With black rubber bulb. Handy for giving medication orally or into eyes or ears. Especially for smaller pets or exotics. 1ml calibrated. 5/pk. **Jorvet**

| | | |
|--------|--------------|------------|
| JORR24 | 1-ml, 5 Pack | \$11.10/pk |
|--------|--------------|------------|



13822 WEST BOULTON BLVD. METTAWA, IL 60045

Phone 800-544-7521

198

WWW.SHOPMEDVET.COM

Fax 800-204-2177

Vials & Containers

Sundry Jars

Sundry Jars

These deluxe sundry jars feature unbreakable plastic in either white opaque or clear polystyrene. Jars are permanently labeled in blue and come with clear lids for easy viewing.

| | | |
|--------|-------------------------------|------------|
| 39-800 | White Opaque 5/Set | \$22.00/ea |
| 39-801 | White Opaque, Each, Unlabeled | \$5.00/ea |
| 39-802 | Clear 5/Set | \$22.00/ea |
| 39-803 | Clear, Each, Unlabeled | \$5.00/ea |



Jorvet Sundry Glass Jars Labeled

The standard for every exam or treatment area. Set of five. Labeled:

- Applicators
- Bandages
- Cotton
- Tongue Depressors
- Gauze.

JOR619G Set of 5 \$33.00/pk



Jorvet

Jorvet Sundry Jars Clear Tops

Features clear tops and bases. 4 3/4" dia. x 6 1/2" H. 5/Set. Acrylic (Wall rack not included.)

JOR619 Set of 5, Clear \$28.50/ea

Jorvet

JOR619

JOR619R

Jorvet Sundry Jar Wall Rack

Plexiglass Wall Rack.

JOR619R \$51.00

Jorvet Glass Sundry Jars

| | | |
|---------|------------------|------------|
| JOR619H | Applicator | \$10.50/ea |
| JOR619J | Bandage | \$10.50/ea |
| JOR619K | Cotton | \$10.50/ea |
| JOR619N | Gauze | \$10.50/ea |
| JOR619M | Tongue depressor | \$10.50/ea |



Jorvet

JOR619H-M

JOR619H Unlabeled

Jorvet Sundry Glass Jars

Set of five unlabeled plain glass jars.

JOR619K Unlabeled, set of 5 \$33.00/pk

Jorvet

Sundry Jar w/Cartoon Characters

Front panel labels with funny cartoons. Opaque bases.

JOR619C 5/Set. 4" dia. x 6 1/2" H. Acrylic. \$58.50/ea



Jorvet

Jorvet Alcohol Dispenser

This handy pump bottle dispenses alcohol by pressing down on the top lid. Great for use in the exam room for alcohol wipes, pre-injection in vaccinations. 8 oz. amber polypropylene bottle.

JOR614 8 oz \$12.00/ea



Jorvet P-Cup

P-Cup Urinary Retriever. Getting a decent urine sample from canine patients is a challenging endeavor. The "P" Cup was designed to ease this challenge. It consists of flexible twin metal rods that hold a sterile, shallow plastic specimen dish. The 19" length allows the sample container to be slipped under the patient when they stop to urinate.

JOR889 Complete \$6.40/ea
 JOR889D1 P-cup only, Sterile, 6pk \$7.95/pk



13822 WEST BOULTON BLVD. METTAWA, IL 60045

Phone 800-544-7521

199

WWW.SHOPMEDVET.COM

Fax 800-204-2177

Vials & Containers

Dropper Bottles, Ointment Jars & Pill Supplies



Yorker Dropper Bottle

Removable dropper tips allow refilling. Bottle and tips are made of low density polyethylene. Screw cap made of polystyrene. 12 per box.



| | | |
|---------|--------------|------------|
| 97-5015 | 15ml 12/Box | \$4.80/box |
| 97-5030 | 30ml 12/Box | \$5.60/box |
| 97-5060 | 60ml 12/Box | \$6.20/box |
| 97-5125 | 125ml 12/Box | \$9.00/box |

Ointment Jars

Plastic ointment jars in sizes from 1 oz. to 16 oz. Approx. diameter 1 1/8", height 2 3/4"



| | | |
|------|-------------|------------|
| OJ1 | 1 oz 48/cs | \$16.00/cs |
| OJ2 | 2 oz 48/cs | \$20.00/cs |
| OJ4 | 4 oz 48/cs | \$25.00/cs |
| OJ8 | 8 oz 48/cs | \$30.00/cs |
| OJ16 | 16 oz 24/cs | \$32.00/cs |

Specimen Container

Clear plastic with screw caps, frosted label & graduation showing ounces and mL.



| | | |
|-------|------------------------|------------|
| 30330 | 4oz Sterile 100/cs | \$22.00/cs |
| 30335 | 4oz Non-Sterile 500/cs | \$49.50/cs |

Jorvet Sterile Disposable Specimen Container

Graduated specimen container. A leak proof lid. Wide base for stable reliable use. Seal label assures internal sterility. Green cap.

| | | |
|----------|-------------------------|-------------|
| JOR555 | 4 oz., (120ml) 100/bag | \$27.60/bag |
| JOR555NS | 4 oz., 100, Non-Sterile | \$24.30/cs |



Souffle Cup

Soufflé Cups: Pleated portions are made of one-piece, dry-waxed construction for durability. Rims are tightly rolled for rigidity, and the base is recessed to prevent tipping. Cup doubles as a drinking cup. 3/4 oz.

| | | |
|-----------|---------------------------|-----------|
| NON024215 | Souffle cup 3/4 oz 250/bx | \$3.40/bx |
|-----------|---------------------------|-----------|



Jorvet Fecal Specimen Container with Spoon

A proper fecal exam is an essential part of any wellness program. However getting proper owner compliance is a challenge. The Jorvet fecal specimen containers are an effective way to help assist the pet owner in getting a quality stool sample.

- Clear plastic vial-can readily see sample
- Snap on lid-easy for clients i.e. geriatric to close container
- Flat bottom-can stand right up.
- Spoon attached to cap-can get stool sample with proper hygiene
- Patient stick on label-identifies proper client and patient
- Inexpensive-great for dispensing to client

Note: not designed for use as a floatation chamber

| | | |
|---------|---|-------------|
| JOR1069 | Specimen container 18ml w/spoon push cap. | \$25.50/bag |
|---------|---|-------------|



Plastic Squeeze Bottle with Flip Top

| | | |
|-------|---------------------------------------|-----------|
| B199N | White, 16 oz, 2.5" Diameter, 8" High | \$1.15/ea |
| B302 | White, 8 oz, 2.5" Diameter, 6.5" High | \$0.85/ea |
| B359 | White, 4 oz, 1.5" Diameter, 5.5" High | \$0.70/ea |



Pill Envelope

| | | |
|--------|-------------------------|------------|
| PILL-E | 2 1/2" x 4 1/4", 500/bx | \$19.95/bx |
|--------|-------------------------|------------|



Jorvet Pill Envelopes

Heavy weight tan paper stock with gummed flaps. Imprinted with standard prescription to fill in. Convenient for small pill quantities.



| | | |
|--------|-------------------------|------------|
| JOR934 | 3 1/2" x 2 1/4", 100/bx | \$20.00/bx |
|--------|-------------------------|------------|



Jorvet Pharmacy Folding Cartons

Inexpensive pill dispensing cartons. Heavy white paper board with marked "directions". 100/pkg



| | | |
|---------|----------------------------------|-------------|
| JOR933A | Small, 1 1/4" x 2 1/4" x 1 5/16" | \$19.20/pkg |
| JOR933B | Medium, 2 1/2" x 1 1/2" x 3/4" | \$30.50/pkg |



Pill Crusher-Splitter

Crushes pills to a fine powder Splits pills in halves or quarters. Separate twin compartment to store dry medicine. Great size for travel, fits in your purse. Heavy duty plastic.

| | | |
|--------|-------------|-----------|
| EZPILL | split/crush | \$6.95/ea |
|--------|-------------|-----------|



Jorvet 7-day Pill Case

Certain medications like thyroid, heart and epilepsy treatments need to be given every day to be effective. This pill case is a great aid for increasing owner compliance in administering medications. It is clearly labeled for "Pets Only," and shrink wrapped on an attractive display card.

| | | |
|--------|---------------------|-----------|
| JORR23 | Labeled "Pets Only" | \$1.30/ea |
|--------|---------------------|-----------|



Vials & Containers

Bio Hazard Supplies, Pet Carrier & Cadaver Bags



Cadaver Bag

Made from extra heavy duty black 3 mil, Polyethylene. Sold individually. 100 bags per roll. Dispenser sold separately.

| | | | |
|--------|----------------|-----------|---------------|
| CB2436 | 24" x 36" 3mil | \$0.50/ea | 100+\$0.45/ea |
| CB3048 | 30" x 48" 3mil | \$0.77/ea | 100+\$0.67/ea |
| CB4050 | 40" x 50" 3mil | \$0.95/ea | 100+\$0.85/ea |



Jorvet Cadaver Bags

Heavy-duty 4 mil black plastic. Strong enough to handle the sanitary disposal of animals. Full 35" x 48". 25 bags/pk. (not pictured)

| | | |
|--------|---------|------------|
| JOR108 | 25 pack | \$28.00/pk |
|--------|---------|------------|

Jorvet

Drape Dispenser

Dispenser also available, for full roll quantities*. Can be desk or wall mounted. *Note: For dispenser to be utilized, you must order the entire roll. Only rolls are shipped with the cores necessary for dispenser use.

| | | |
|-----|----------|------------|
| H29 | 24" Each | \$21.95/ea |
|-----|----------|------------|



Bio Hazardous Disposable Pouches

Safely contain sharp-edged objects like scalpel blades and needles for disposal. The 10mm thick paperboard folds to an oval shape. The bottom is secured by double-sided tape on one flap. The fold-down top secures bag when full. English instructions on front, Spanish on back. Inexpensive. 5 1/2" x 13". 100 pouch/pk.

| | | |
|--------|-------|------------|
| JOR723 | 100pk | \$68.00/pk |
|--------|-------|------------|

Shown with JOR724H
Sold Separately



BioHazardous Pouch Stand

Epoxy-Coated Steel Wire Stand attractively holds pouch. Put one in every exam room.

| | | |
|---------|------|------------|
| JOR723H | Each | \$16.20/ea |
|---------|------|------------|

Jorvet

BioHazard Bags

Handy size bag and holder are ideal for collecting lab samples like blood tubes. Bag stays open until you are ready to dispose of it. These 1.5mm thick polypropylene bags can be safely autoclaved. An indicator patch darkens when sterilized. Very inexpensive.

| | | |
|--------|---------------------------|------------|
| JOR724 | 3.6" x 5.1" x 8.4" 100/pk | \$18.30/pk |
|--------|---------------------------|------------|

BioHazard Bag Holder

Epoxy-Coated Steel Wire Holder.

| | | |
|---------|------|------------|
| JOR724H | Each | \$20.70/ea |
|---------|------|------------|

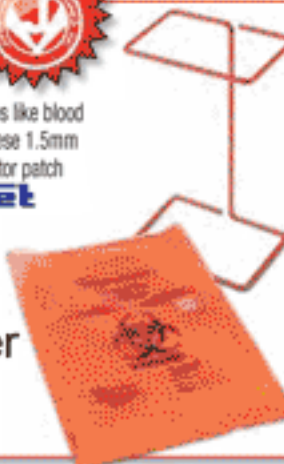

Pet Carrier

200 lbs test white cardboard

- 17"L x 12 3/4"H x 8"W
- Special water based coating provides moisture resistance.
- Safe, no staples, strong glued joints and extra ventilation.
- Recyclable, approximately 70% post-consumer recycled product.
- Printed warning "Do not leave animal(s) unattended in carrier."
- Easy assembly instructions on carriers. Easy one-piece construction.
- Sold by the dozen.

| | | |
|-------|---------|------------|
| PET-C | 12/Case | \$34.50/cs |
|-------|---------|------------|



Pocket Pet Carrier for Small Animals

- 200 lbs test white cardboard
- 10"L x 6 3/4"H x 5 1/2"W
- Special water based coating provides moisture resistance.
- Safe, no staples, strong glued joints and extra ventilation.
- Recyclable, approximately 70% post-consumer recycled product.
- Easy one-piece construction.
- Sold by the dozen.

| | | |
|--------|-----------|------------|
| PET-PC | 12/carton | \$19.75/cs |
|--------|-----------|------------|



BioHazard Waste Disposal "Touch Free" Jorvet

P2.5 gallons, white perfect for benchtop use and includes a removable rigid liner that won't leak or rust.

| | | |
|---------|--------------------------------|-------------|
| JOR991 | 2 1/2 gallon, "Touch Free" | \$69.00/ea |
| JOR991A | 7.3 gallon, each, "Touch Free" | \$130.50/ea |



Jorvet Biohazard Disposal Bags

Orange-red. Look for the sterilization indicator patch. The days have passed when veterinarians simply disposed of their hazardous waste like surgery gloves, drape, and animal body parts in the trash. Medical standards require responsible disposal of medical waste in appropriately marked bags that can be safely autoclaved. A large biohazard symbol and precautionary in four languages are clearly visible for safety. Made of high molecular weight, high density (HMHD/polyethylene) and are steam autoclavable up to 121°C (250°F).

| | | |
|----------|------------------|-------------|
| JOR1067 | 2-4 gallon, 50pk | \$46.60/pk |
| JOR1067A | 6-9 gal, 50pk | \$57.90/pk |
| JOR1067B | 20-30 gal, 50pk | \$114.00/pk |



13822 WEST BOULTON BLVD. METTAWA, IL 60045

WWW.SHOPMEDVET.COM

Phone 800-544-7521

201

Fax 800-204-2177

Intravenous Products

IV Sets, T-Connectors & IV Stands

IV Extension Set

NEXTINJ 30" With Injection Site \$0.75/ea **100+50¢/ea** **TOP SELLER**

Jorvet T-Port Small Bore Extension Set

This set is different in that the "T" port itself is needle free. It will accept male luer lock and slip connections. Male spin luer lock. Micro bore tubing. Female luer lock. 5" length (12.7cm). 0.3ml priming volume. Slide clamp.

JOR467G \$3.70/ea **Jorvet**



Stopcock 3-Way

Directional flow knob is labeled with "off." Useful in recognizing flow direction. Sterile. Vet Use.

3WSTOP 3-Way Sterile \$0.90/ea 100+\$0.75/ea



Jorvet 3-way Stopcock Attached to Male Barbed Fitting

Three-Way Stopcock permanently attached to male-barbed connector. Stopcock has two female luer connectors that can be attached to: a luer syringe, IV-set, or "T" bore connector. The barbed connector can be attached to: Foley, or other catheters, chest drain, or small stomach tubes.

JOR599X Sterile \$6.50/ea **Jorvet**

Jorvet Discifix 3-Way Stop Cock

Directional flow knob is labeled with "off." This is useful in recognizing flow direction. Sterile.

JOR462 \$0.96/ea



Jorvet IV Extension Set w/Stopcock

With three-way stopcock. One end female luer slip and the other end is a male spin luer lock. Sterile. **Jorvet**

JOR1039 \$2.20/ea



Injection Cap

Sterile, single use. Compatible with all IV. Catheters. Ideal for use as a catheter plug. Luer lock.

INJCAP Each \$0.50/ea **TOP SELLER**



Jorvet Danish IV Needle

Intravenous Needle with case. **Jorvet**

JOR50B 3" Shaft, 3mm (-11g). \$27.00/ea
 JOR50A 3" Shaft, 2.5mm (-14g). \$25.50/ea
 JOR50C 3" Shaft, 3mm (-7g). \$45.00/ea



IV Administration Set

Our IV sets features Universal kink resistant tubing with smooth action roller clamp, and Y injection site. Available in 10, 15, 20 and 60 drop per mL sizes Compatible with both bottles and bags.



| | | | | |
|-----|---------|--------------------------|-----------|---------------|
| N10 | 100r/ml | 100" With Injection Site | \$1.00/ea | 100+\$0.75/ea |
| N15 | 150r/ml | 100" With Injection Site | \$1.00/ea | 100+\$0.75/ea |
| N20 | 200r/ml | 72" With Injection Site | \$1.00/ea | 100+\$0.75/ea |
| N60 | 600r/ml | 72" With Injection Site | \$1.00/ea | 100+\$0.75/ea |

IV T-Connector

Distal end has a female luer fitting. Proximal end has male luer lock with latex injection port. Also slide clamp for control. Sterile. 6" length.

T-PORT 6" Standard Bore \$1.95/ea 50+\$1.25/ea **TOP SELLER**
 T-PORT-MB 6" Microbore \$1.95/ea 50+\$1.25/ea



Jorvet IV Extension Set w/Flow Control

With flow rate regulator This 19" extension set has an adjustable dial that controls the flow rate in ml/min. It has a female luer fitting on one end and a male spin luer lock on the other. A "Y" site is located just above below the controller. **Jorvet**

JOR1038 \$4.50/ea



Jorvet IV Extension Set w/two Y Sites

- With two "Y" sites 32" length, with two slide clamps
- Male spin luer lock distal end
- Female luer lock proximal end **Jorvet**

JOR1039A \$1.65/ea



IV Stand

Constructed of durable steel with a large 18" diameter, four-legged base for excellent stability. Two ram's horn style hooks; height adjusts from 47" to 85".

INPOLE Each \$39.99/ea
 INPOLE-DELUXE Each \$89.50/ea Not Pictured

Jorvet Deluxe IV Stand

24" dia. five-leg aluminum base is more stable than the economy model. Brushed chrome, dual caster, and four prong hooks.

JOR266 4 hooks, Adjustable 54"-84"H. \$142.00/ea
 JOR266A 2 hooks \$138.00/ea

Jorvet Economy IV Stand with 2 Hooks

The stand features a 21" dia. painted base, open casters, a knurled twist lock, and a welded two-hook top. Adjustable 45"-83"H.

JOR266E \$60.00/ea

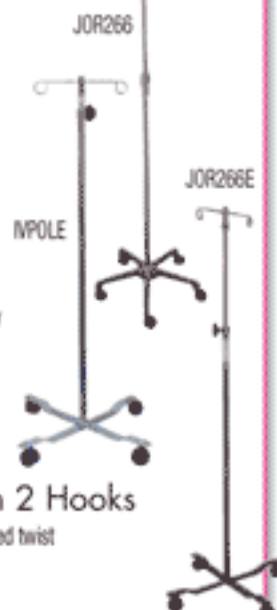

Intravenous Products

Catheters & Infusion Sets

IV Catheter Vet Use

| | | |
|------------|---------------------------|-------------|
| NC16X2.25V | 16 X 2.25" Vet Use 50/box | \$25.00/box |
| NC20X1.25V | 20 X 1.25" Vet Use 50/box | \$25.00/box |
| NC22X1V | 22 X 1" Vet Use 50/box | \$25.00/box |
| NC24X3/4V | 24 X 3/4" Vet Use 50/box | \$25.00/box |
| NC14X2.25V | 14 X 2.25" Vet Use 50/box | \$25.00/box |



Butterfly Infusion Set

| | | |
|-------|--------------------------------|-------------|
| 26702 | 12" tubing, 19g x 3/4", 50/box | \$15.99/box |
| 26703 | 12" tubing, 20g x 3/4", 50/box | \$15.99/box |
| 26704 | 12" tubing, 21g x 3/4", 50/box | \$15.99/box |
| 26706 | 12" tubing, 23g x 3/4", 50/box | \$15.99/box |
| 26708 | 12" tubing, 25g x 3/4", 50/box | \$15.99/box |
| 26709 | 12" tubing, 27g x 3/4", 50/box | \$15.99/box |



Butterfly Infusion Set

Latex free, individually packaged, small vein infusion set. The thin, stainless steel cannula is siliconized for easy insertion. They are sterilized with ethylene oxide and ready for immediate use. Flexible wings hold the needle in position and help to prevent inadvertent pull out.

| | | |
|---------|--------------------------------|-------------|
| D3K223G | 12" tubing, 23g x 3/4", 50/box | \$24.95/box |
| D3K225G | 12" tubing, 25g x 3/4", 50/box | \$24.95/box |
| D3K221G | 12" tubing, 21g x 3/4", 50/box | \$24.95/box |



Winged Infusion Set

Soft, color-coded wings have non-slip grip and safety dots for user protection, and PVC tubing is non-toxic and flexible. Broad range of sizes (27G - 18G) accommodates virtually any patient need.

| | | |
|---------|-----------------------------|-------------|
| PR18G19 | 18g x 3/4 12" tubing 50/box | \$14.99/box |
| PR21G19 | 21g x 3/4 12" tubing 50/box | \$14.99/box |
| PR19G19 | 19g x 3/4 12" tubing 50/box | \$14.99/box |
| PR23G19 | 23g x 3/4 12" tubing 50/box | \$14.99/box |
| PR25G19 | 25g x 3/4 12" tubing 50/box | \$14.99/box |



Jorvet Large Animal IV Catheter

Large animals need large volumes of IV fluids in a short period of time. Naturally, the IV catheter needs to be a large bore, and often is even put in bilaterally to maximize fluid administration speed.

Features:

- Large bore: 10g and 14g catheters. The 10g is the largest available.
- Longer lengths: 51/2" catheter lessens the risk of pulling out the catheter.
- Pebax® catheter implant grade material: much less bioactive to lessen thrombosis formation for long term >3 days placement.
- Kink resistant: other catheters like Teflon will kink upon bending, making them unusable.
- Clear catheter material versus opaque Teflon.
- Suture patch: a thin, flexible patch with twin eyelets. Allows suturing in place or hold with tissue adhesives. Reduces catheter pull-out.
- Competitive pricing and available through JorVet distributors.

| | | |
|---------|-----------|------------|
| JOR457A | 14g x 5.5 | \$10.20/ea |
| JOR457B | 10g x 5.5 | \$10.50/ea |

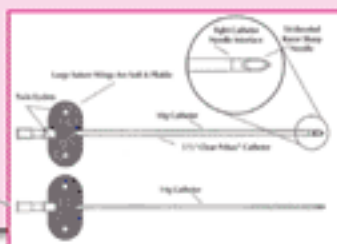

JorVet

IV Catheter

Terumo IV Catheters

| | | | |
|------------|------------|-----------|--------------|
| SR0X1451CA | 14 X 2" | \$1.00/ea | 50+\$0.75/ea |
| SR0X1632CA | 16 X 1.25" | \$1.00/ea | 50+\$0.75/ea |
| SR0X1651CA | 16 X 2" | \$1.00/ea | 50+\$0.75/ea |
| SR0X1664CA | 16 X 2.5" | \$1.00/ea | 50+\$0.75/ea |
| SR0X1864CA | 18 2.5" | \$1.00/ea | 50+\$0.75/ea |
| SR0X1832CA | 18 X 1.25" | \$1.00/ea | 50+\$0.75/ea |
| SR0X1851CA | 18 X 2" | \$1.00/ea | 50+\$0.75/ea |
| SR0X2025CA | 20 X 1" | \$1.00/ea | 50+\$0.75/ea |
| SR0X2032CA | 20 X 1.25" | \$1.00/ea | 50+\$0.75/ea |
| SR0X2051CA | 20 X 2" | \$1.00/ea | 50+\$0.75/ea |
| SR0X2225CA | 22 X 1" | \$1.00/ea | 50+\$0.75/ea |
| SR0X2419CA | 24 X 3/4" | \$1.00/ea | 50+\$0.75/ea |



Extended Use Polyurethane Catheter

Most traditional jugular catheters are Teflon. They can create a thrombosis and crack if left in place for over 48 hours. The development of new materials allows large-bore catheters that can safely be left in-dwelling for up to 10 days. The JorVet Extended Use Catheter softens at body temperature. Many of the common catheter-related problems, such as phlebitis, can be minimized with these catheters.

- 14g and 16g polyurethane catheter over needle
 - Non-thrombogenic and non-cracking
 - Can be safely left in the vein for up to 10 days
 - This same catheter is used in 24 out of 27 U.S. veterinary teaching hospitals
- Suture wings with holes or suture groove attachment

| | | |
|---------|--------------------|------------|
| JOR458B | 16g x 5 1/4" | \$10.50/ea |
| JOR458C | 16g x 3", foal | \$10.80/ea |
| JOR458D | 14g x 3 1/2", foal | \$10.80/ea |
| JOR458A | 14g x 5 1/4" | \$10.50/ea |



Plastic Urethral Catheter

JorVet

Clear Vinyl Intermittent Self Catheters: Suitable for male or female catheterization. Smooth tip, comfort eyes and funnel end. Radiopaque. Male/Universal Clear Vinyl Intermittent Self Catheter.

| | | |
|-----------|-------------------|------------|
| DYND10700 | 14Fr, 16" Length. | \$55.00/cs |
|-----------|-------------------|------------|

Jorvet IV Catheter Guard

JorVet

There is nothing more frustrating than working hard to place an IV catheter in a critically ill patient only to have the patient remove it. The IV Catheter Guards are a quick and inexpensive way to detour your patients from chewing or licking on their IV catheters. They are made of a thin lightweight flexible plastic with holes for air circulation. The IV catheter guard is held in place by velcro straps that wrap around the limb. The rough surface of the velcro seems to deter most patients from licking. Straps are reusable, but also inexpensive to replace if damaged. University tested and recommended. Directions for Use: Select the correct size from the four sizes available. Loosen velcro straps. Place IV Guard over the catheter as shown. Wrap velcro straps around the leg and tighten on IV Guard. Soak or gently scrub with disinfectant solution or bleach between uses. Four sizes available!

| | | |
|---------|----------|------------|
| JOR644S | set of 4 | \$22.20/ea |
| JOR644 | Small | \$4.65/ea |
| JOR644A | Medium | \$4.95/ea |
| JOR644B | Large | \$6.15/ea |
| JOR644C | X-large | \$7.05/ea |



13822 WEST BOULTON BLVD. METTAWA, IL 60045

WWW.SHOPMEDVET.COM

Phone 800-544-7521

203

Fax 800-204-2177

Central Venous Catheter Kit & Infusion Sets/Pumps



Jorvet Central Venous Catheter Kit

These long-term catheters have been the standard of critical care in human medicine for many years. The catheters are placed in the jugular vein using a technique called Seldinger. It uses a guide wire system.

- Non-reactive polyurethane catheter: can be left in place for extended use i.e. 3-4 weeks.
- Single, double or even triple lumen catheters of various lengths: allows administration concurrently of different IV medications.

Kit consists of:

- Polyurethane radiopaque catheter with clamp
- Introducer needle
- Vessel dilator
- Guide wire
- Injection caps
- 5ml syringe
- Illustrated directions



Jorvet

| | | |
|----------|-------------------------------------|------------|
| JOR1040 | 20g X 8cm (3 1/4"), Single lumen | \$15.50/ea |
| JOR1040A | 20g X 13cm (5 1/4"), Single lumen | \$15.50/ea |
| JOR1041 | 18g X 8cm (3 1/4"), Single lumen | \$15.30/ea |
| JOR1041A | 18g X 13cm (5 1/4"), Single lumen | \$15.30/ea |
| JOR1042 | 16g X 13cm (5 1/4"), Single lumen | \$13.00/ea |
| JOR1042A | 16g X 20cm (8"), Single lumen | \$13.00/ea |
| JOR1044 | 4fr X 13cm (5 1/4"), Double lumen | \$27.00/ea |
| JOR1044A | 7fr X 20cm (8"), Double lumen | \$20.00/ea |
| JOR1044B | 7fr X 30cm (12"), Double lumen | \$20.00/ea |
| JOR1045 | 5.5fr X 13cm (5 1/4"), Triple lumen | \$28.00/ea |
| JOR1045A | 7fr X 20cm (8"), Triple lumen | \$24.50/ea |
| JOR1045B | 7fr X 30cm (12"), Triple lumen | \$24.50/ea |

JOR1040

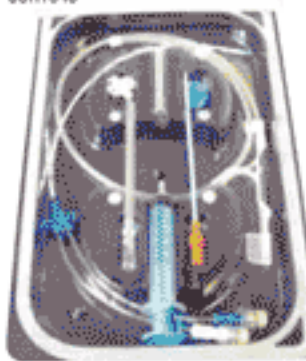

Jorvet Lightweight IV Infusion Pump

IV Set requirement: Standard IV set (10, 15, 20, or 60 drops/ml), or micro drip IV set (60 drops/ml) with 3.4-3.5 mm tubing. Best if Baxter or Abbott IV sets are used.

- Flow rate setting range: 1 ml/h-999 ml/h
- Drip rate setting range: 1 drop/min-333 drops/min
- Flow rate step: 1 ml/h Flow rate accuracy: +/-5% (standard PVC set must first be adjusted)
- Drip rate accuracy: +/- 2%
- Volume infused display: 0-9999 ml
- Volume limit setting range: 0-9999 ml
- Purge rate: 600 ml/h
- Keep Vein Open Flow Rate: 1 ml/h
- Occlusion Pressure: 40kPa-140kPa, 8 levels occlusion sensitivity
- Alarms: Infusion Monitoring: Air in tube, door open, occlusion, pause, infusion complete, abnormal drips, leakage, tube slope, etc.
- Diagnosis malfunctions: Low battery, damage battery, abnormal drip detector, abnormal peristaltic finger pump.
- Power source: 110V/60Hz
- Inner battery: Rechargeable Ni-hydrogen battery, DC12V, 2000mAh
- Charge: 16 hours
- Discharge time: >5 hours
- Power consumption: <15VA
- Weight: 2.1 kg
- Dimensions: 140mm x 168mm x 230mm

JOR1060 5" d x 7" w x 9" h \$990.00/ea



Jorvet



Jorvet Infusible Pressure Infusor

Pressure infuser for collapsible IV bags. IV bag fits inside mesh and nylon bag. A rubber hand pump attached to a 3-way stop cock allows bag to be filled with air, which exerts pressure on the IV fluid bag.

JOR320P 1 Liter \$50.00/ea



Jorvet Complete Infusion Set

Complete Infusion Set that can handle the large volume of fluid therapy necessary in large animals. The Willoughby style tubing stretches to 10', allowing movement to a restrained or stalled animal. It has a collapsible container made for easy storage in a mobile unit. Non-sterile.

JOR64S 5 liter \$28.00/ea
 JOR64SL 20 liter \$39.00/ea

Jorvet Collapsible Plastic Bag for Infusion Set

JOR64B 5-liter bag only, Non-sterile \$18.60/ea
 JOR64BL IV bag with adaptor, 20 liter \$22.20/ea



Jorvet Transfer Bag

Designed to receive blood components or plasma, transfer bags have 2 spike entry ports and a single transfer spike with tubing. Sterile. Do not contain anticoagulants.

JOR520TA 150 ml \$7.50/ea
 JOR520TB 300ml \$9.00/ea
 JOR520TC 600ml \$9.00/ea
 JOR520TD 1 liter \$10.50/ea

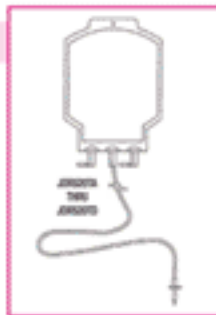

Jorvet Winged IV Infusion Set

These popular sets are commonly known as Butterfly® style IV sets. They are great for short term IV infusion or in difficult venipunctures. Tubing with female luer fitting is 12" long. A 3/4" razor sharp needle is attached to flexible colored coded wings. Priced very inexpensive.

JOR454A 19g. Yellow, Sterile. 100/box. \$25.00/box
 JOR454B 21g. Green, Sterile. 100/box. \$25.00/box
 JOR454C 23g. Blue, Sterile. 100/box. \$25.00/box
 JOR454D 25g. Orange, Sterile. 100/box. \$25.00/box

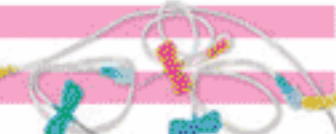

Jorvet Transfusion and Infusion Set

Blood Transfusion and Infusion Set with filter and plastic drip chamber. Roller clamp is flowregulating. Sterile. Disposable. 20 drops/ml.

JOR65 20 drops/ml. \$3.00/ea



Intravenous Products

Blood Collection, Lactated Ringers & IV Splints

Jorvet Small Animal Blood Collection Set

The addition of these blood collection sets allows for easier and proper feline and small animal blood collection. They are a complete closed system that will get better blood component results, i.e., packed RBC or plasma. The bags are provided dry and anticoagulant (JORS22) will need to be added. The sets come in two basic formats: a set with 19g butterfly needle or a 60cc syringe with a 3-way stop cock. Small blood bag collection set.

- 100 dry (blood) collection bag
- 19g butterfly needle with tubing
- complete directions

| | | |
|----------|-------------------------------------|-------------|
| JORS20AB | 19g butterfly needle with tubing | \$6.90/set |
| JORS20AX | 60cc syringe with a 3-way stop cock | \$10.05/set |



Jorvet Single Collection Unit Prefilled CPDA-1 w/anticoag. & needle

CPDA-1 is the anticoagulant of choice in human blood banking. After collection, stored blood will have a 35-day shelf life. Bag comes with 16g diamond point non-detachable needle plus double spike ports.

| | | |
|--------|--------|-----------|
| JORS20 | 450ml. | \$5.75/ea |
|--------|--------|-----------|

Jorvet Blood Bag 250 w/ CPDA #1 Single Collection Unit Prefilled CPDA-1, 250ml.

| | |
|---------|-----------|
| JORS20Q | \$5.40/ea |
|---------|-----------|

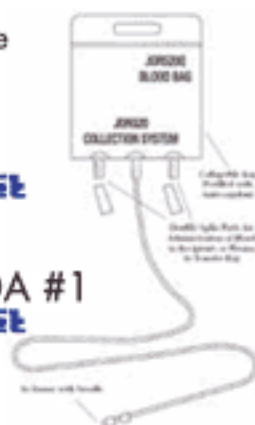

Jorvet Cochran IV Splint

Small animal veterinarians often are confronted with the problem of administering a continuous or uninterrupted IV drip to an unattended patient. The cephalic vein is easily occluded when an animal is in a sternal position with the elbow in flexion. The patented Cochran IV Splint is the first product that allows the animal to lie comfortably and still ensure a continuous IV flow. This IV splint will enable the practitioner to extend the patency and longevity of an IV catheter and administer a more continuous and even flow of IV fluids to critically ill patients.



| | | |
|---------|---------------------------|-------------|
| JOR267A | small | \$33.00/ea |
| JOR267B | medium | \$40.50/ea |
| JOR267C | large | \$45.00/ea |
| JOR267D | x-large | \$48.00/ea |
| JOR267S | Complete set of 4 splints | \$150.00/ea |

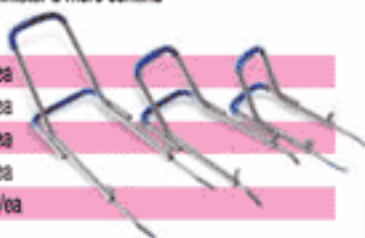

Jorvet Blood Bag

Provide your own anticoagulant for the use of these blood bags. Two spike ports with donor tubing with "Y" injection port. Includes directions for use.

| | | |
|---------|-----------------|------------|
| JORS20A | Dry, 50 - 150ml | \$5.10/ea |
| JORS20B | Dry, 300ml | \$7.80/ea |
| JORS20C | Dry, 600ml | \$7.80/ea |
| JORS20D | Dry, 1 liter | \$8.40/ea |
| JORS20F | Dry, 4 liter | \$22.20/ea |

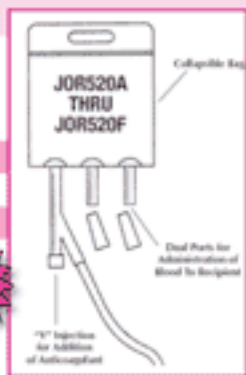

Normosol-R IV Fluids

| | | |
|--------------|--------|-----------|
| RXNORMOSOL-R | 1000ml | \$3.86/ea |
|--------------|--------|-----------|

Lactated Ringers IV Solution

| | | |
|--------------|--------|-----------|
| RXRINGL-250 | 250ml | \$1.60/ea |
| RXRINGL-500 | 500ml | \$1.79/ea |
| RXRINGL-1000 | 1000ml | \$1.99/ea |

with 5% Dextrose IV Solution

| | | |
|--------------|--------|-----------|
| RXRINGL-250 | 250ml | \$1.60/ea |
| RXRINGL-500 | 500ml | \$1.79/ea |
| RXRINGL-1000 | 1000ml | \$1.99/ea |

0.9% Sodium Chloride Injection

| | | |
|-----------------|------------------------|-----------|
| RX0.9NACL-100 | 100ml bag, 4 bags/pack | \$6.62/pk |
| RX0.9NACL-250ML | 250ml bag | \$1.69/ea |
| RX0.9NACL-500ML | 500ml bag | \$1.79/ea |
| RX0.9NACL-K | 1000ml bag | \$1.99/ea |



Jorvet Blood Collection with Attached Transfer Bag

Considered a closed system, this is useful for separating blood components. Collect blood from a suitable donor in the 450ml bag containing the CPDA#1 anticoagulant via standard blood collection techniques. The blood is separated into plasma and red blood cells portions refrigerated upright either via standing gravity or blood centrifuge. Store the bag with the transfer tube on the bottom since concentrated RBCs are heavier. After separation gently snap the white plastic stopper into half to open the transfer channel which allows concentrated RBC to drain into the attached transfer bag. After completion of transfer the connecting tubing is cut and sealed. Benefits include the ability to freeze the plasma portion for an extended period. Concentrated RBC's can be given to an anemic patient in a much smaller volume.

| | | |
|---------|---|-----------|
| JORS20X | Blood Collection with Attached Transfer Bag | \$9.00/ea |
|---------|---|-----------|

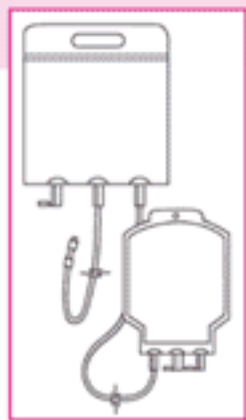

Jorvet Hespan Bag

Hespan (Hetastarch), 500ml. A sterile solution of 6 percent hetastarch in 0.9 percent saline. Hetastarch is colloid solution that acts as a plasma expander in cases of hypovolemic shock.

| | | |
|--------|------------|------------|
| JOR845 | 500ml. bag | \$28.50/bg |
|--------|------------|------------|



Intravenous Products

Jorvet Extension Sets

Jorvet Extension Set 30" w/Male Spin Luerlock

30" (76.2cm) proximal end: female luer. Distal end: male spin luer lock.
4ml priming volume. Side clamp. **Jorvet**

JOR467P \$1.95/ea

Jorvet IV Extension w/ Needleless Valve & Luerslip

Female luer slip needleless valve and opposite end male luer slip. Sterile. 6".

JOR467Y \$2.70/ea

Jorvet IV Extension Set 30" Male Luer Lip

30" with male luer female luer lock. 30" standard bore tubing. Sterile.

JOR467B 30" with male luer female luer lock. \$1.20/ea **Jorvet**

Jorvet Micro Bore "T" Extension w/ Luerlock

Same configuration as JOR467S, only with smaller micro-bore tubing. Sterile.

JOR467R \$2.30/ea

Jorvet Standard Bore "T" Extension w/ Luerlock

The distal end is a female luer slip, the proximal end is a male luer spin-lock. The standard bore tubing is equipped with a slide clamp. Injection port is latex-free. Priming volume is 0.69ml. 5"L. Sterile.

JOR467S \$1.80/ea **Jorvet**

Jorvet Standard Bore "T"-Port Extension

Ultrasite female luer lock needle free. Spin male luer lock. Latex injection port. 7.5" length (19.1cm). 1.3ml priming volume. Slide clamp.

JOR467F 7.5" length (19.1cm). 1.3ml priming volume \$3.20/ea

Jorvet IV Extension w/Needleless Valve & T-Port

The open end is a needleless valve female luer slip. The opposite end is right angle male spin luer lock fitting that also has a latex injection port. Sterile. 13g x 7".

JOR467Z \$2.70/ea **Jorvet**

Jorvet Standard "T" Extension Set

Distal end has a female luer fitting. Proximal end has male luer slip with latex injection port. Also slide clamp for flow control.

JOR467T Sterile. 5"L. \$2.18/ea

Jorvet Micro Bore "T" Extension

Same configuration as JOR467T only with smaller bore tubing that is more suitable for smaller patients. Sterile.

JOR467Q \$1.71/ea **Jorvet**

Jorvet Small Bone Extension Set w/Ultrasite

Ultrasite luer lock needle free valve. Male luer lock. 8" length (20.3cm). 0.61ml priming volume. Slide closure clamp.

JOR467D \$2.05/ea

Jorvet Small Bore "T"-Port **Jorvet**

Ultrasite female luerlock needle free. Spin male luer lock. Latex free injection port. Slide clamp.

JOR467E 5.5" length (14cm). 0.66ml priming volume \$2.40/ea

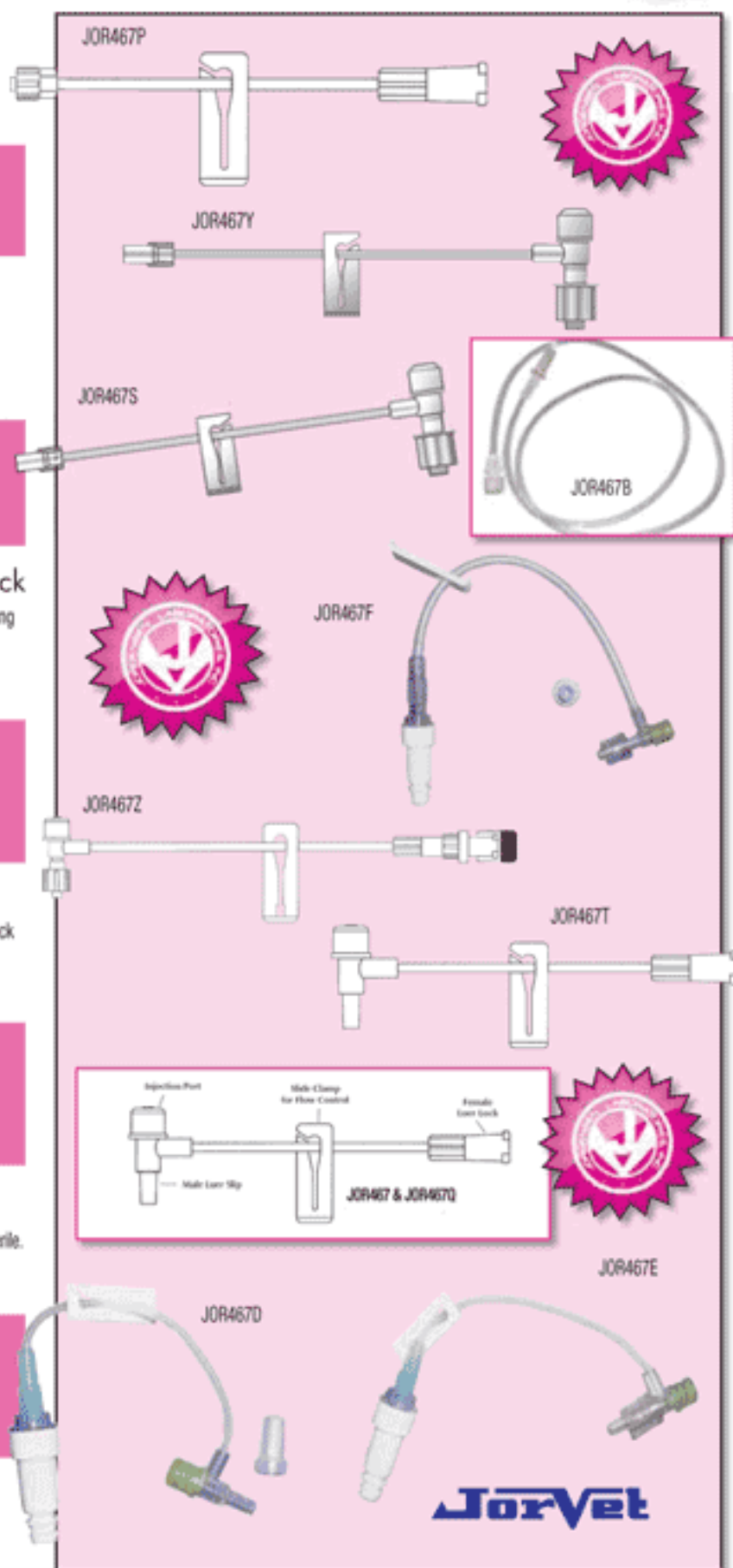

Intravenous Products

Springfusor, Luer Lock Connectors & Adapters

Jorvet Spring Infusor

Jorvet

A simple reusable spring-driver pump used for continuous IV infusions over time, requires no batteries or electricity. The pump is matched with various special sized tubing to determine actual flow rate. Uses include administering oncology and anesthetic drugs, and IV fluids to very small patients.

Features:

- Large variety of flow rates available (e.g., 10ml, 5 minutes to 8 hours)
- Compact and very portable
- Reusable
- No programming required
- Not gravity dependent

| | | |
|---------|-------------------------------|------------|
| JOR831A | Tubing, 10ml/15 minutes, 10pk | \$49.00/ea |
| JOR831B | Tubing, 10ml/30 minutes, 10pk | \$62.00/ea |
| JOR831C | Tubing, 10ml/60 minutes, 10pk | \$62.00/ea |
| JOR831D | Tubing, 10ml/2 hour, 10pk | \$62.00/ea |
| JOR831E | Tubing, 10ml/4 hour, 10pk | \$66.00/ea |
| JOR831F | Tubing, 10ml/8 hour, 10pk | \$98.00/ea |



Jorvet Dual Pinch Tubing Clamp

Slides over tubing for flow control. Accepts up to 6.6m (20ft) tubing.

JOR594 \$3.00/pk **Jorvet**

JOR594

Jorvet Mini-Spike

Great for preparing and dispensing diluent from multi-dose rubber-stopped vials (i.e., Naxcel). Utilizes a bacterial retentive air-venting filter. Female luer lock attachment.

JOR591 Sterile. 5/pk. \$6.30/pk



JOR591

Jorvet Large Bore IV Administration Set

Larger animals such as horses and cattle require tremendous amounts of IV fluids in a short period of time. The standard smaller human IV sets cannot meet the large IV fluid demands of a critically ill 1,200lb horse. The Jorvet Large Bore IV Set can increase the flow rate up to almost 20-liters per hour, a necessary volume in severe colic or equine critical care emergency.

| | | |
|---------|--------------------------|------------|
| JOR400L | Complete Set, Sterile | \$36.00/ea |
| JOR400E | Large Bore Extension Set | \$3.00/ea |
| JOR400T | Large Bore, Transfer Set | \$2.85/ea |

Jorvet



Jorvet Double Christmas Tree Connector

JOR28202 Connects tubing from 4mm to 12mm I.d. 2/pk \$3.00/ea



Jorvet Barbed Connector with Female Luer Lock

Allows connecting of syringe to catheter

JOR28201 Allows connecting of syringe to catheter \$3.30/ea



Jorvet Male Luer Adaptor

Sterile latex injection port with protective cap. Often used to cap catheter

JOR463 Male Sterile \$0.90/ea

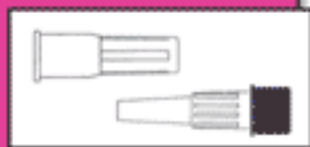

Jorvet Male Luerlock Adapter

Latex injection port. Sterile. 1 1/3"L.

JOR463L \$0.90/ea

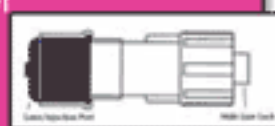

Jorvet Dual Male Adapter

This connector has a male luer lock adaptor on each end. It allows the connection of two female luer fittings. Sterile. 5/pk.

JOR463D 5 pack \$5.10/pk



Injection Adapter

Medline Injection Site: A conventional intermittent injection site; hep lock and prm adapter. Injection Site, Heplock, Pm Adapter.

DYND75030 Hep Lock and PRN Adapter, 200/cs \$136.91/cs



Jorvet Safesite Injection Port

Safesite needle-free injection port w/ cap

JOR463N \$0.93/ea



Jorvet Ultrasite IV Adapter

Allows needle free "syringing" from rubber multi-dose vial bottles without the risk of contamination.

JOR463Q \$1.20/ea



Jorvet Needle Free Multi Dose Vial Adaptor

Allows needle free "syringing" from rubber multi-dose vial bottles without the risk of contamination.

JOR463X \$2.55/ea **Jorvet**



13822 WEST BOULTON BLVD. METTAWA, IL 60045

WWW.SHOPMEDVET.COM

Phone 800-544-7521

207

Fax 800-204-2177

Intravenous Products

IV Bag Holder, IV Pump & IV Holder Track System

Jorvet Cage IV Bag Holder

- The simple design allows easy and quick location change.
- Spring-loaded lock holds and clamps securely onto horizontal cage bar.
- Stainless steel 3/8" solid rod looks attractive and professional.
- Fits any standard size cage door from all manufacturers
- Economical, costs considerably less than other holders
- Cleans and disinfects easily after use

JOR461 4"W x 18"H. 0.65 lbs. \$48.00/ea

Jorvet

Jorvet Space-Saver IV Cage Mount

SpaceSaver Cage Mount will save space and permanently mount on all styles of cages with the ease of dismounting for more flexibility. You can permanently mount and safely secure infusion pumps and IV bags.

JOR461A IV hanger included. \$173.00/ea

Jorvet

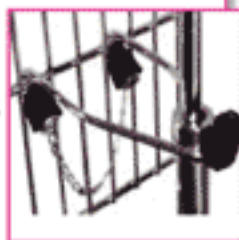

Jorvet IV Latex Surgical Tubing

High quality stretch tubing for a variety of clinical needs. Can be autoclaved. 50'L.

| | | |
|----------|-------------------------------|------------|
| JOR63D1 | 50 ft reel, 3/16" ID | \$36.00/ea |
| JOR63D1A | 50 ft reel 1/8" x 1/32 x 3/16 | \$32.10/ea |
| JOR63D1B | 50 ft reel 1/4" ID x 7/16 | \$52.50/ea |



Jorvet IV Pump

Jorvet

for rapid infusion of large volumes of IV fluids, the rubber bulb pump infuses air into any bottle by needle insertion. Air pressure forces fluid out much quicker than simple gravity.

JOR27R For equine and bovine use. Dark orange. \$12.30/ea



Jorvet IV Set

Simplex IV Bell. High quality latex. 4' tubing. (needle included)

JOR63 Funnel Type \$9.00/ea



Jorvet Complete IV Holder Track System

This simple system puts a moveable IV bag holder on a track that is suspended from the ceiling. The IV holder can be positioned above cages, treatment area, or the surgery table. When not in use, it is simply retracted upward and pushed off to the side.

- Track can be installed into any type of ceiling.
- Lightweight aluminum track comes in any length sections; can be trimmed with hacksaw if needed.
- Four-wheel carrier runs in track. It is locked into position by turning it 360°. A pendant ring is attached to carrier.
- IV holder attached to carrier. It has 4 ram's horns at 90° angle. They each can hold an IV bag. It extends and retracts at the push of a button.
- Oval sections of track are also available. IV holder for four bags (JOR833h)
- Four-wheel carrier with ring (JOR833c)
- Two end caps for track (JOR833e)

Complete IV Holder Track System

JOR833 (track not included) \$270.00/ea

Stationary IV Ceiling Hook

JOR833P (Hardware not included) Suggest attaching JOR833h, IV holder. \$96.00/ea

Splice Plate for IV Track

JOR833S Use to join sections of track over 8' in length. \$5.10/ea

Foot Track Sections (IV Track System)

JOR833T Order track by number of feet desire. 8' maximum for a single piece; splicing needed for longer lengths. \$10.50/ea

IV holder w/ 4 Ring Holder

JOR833H \$214.00/ea

4-wheel Locking Carrier

JOR833C \$62.50/ea

End Cap for IV Track

JOR833E \$5.10/ea



Jorvet

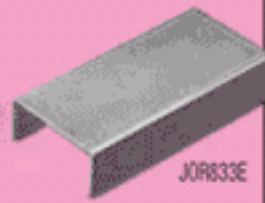
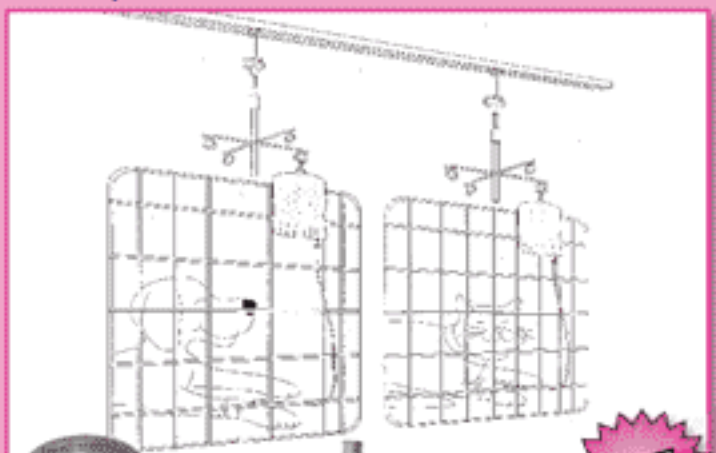

13822 WEST BOULTON BLVD. METTAWA, IL 60045

Phone 800-544-7521

208

WWW.SHOPMEDVET.COM

Fax 800-204-2177

Intravenous Products

IV Fluid Warmer & Large Volume Sets



Jorvet IV Fluid Warmer



Intravenous fluids should be administered as close to body temperature as possible, especially when hypothermia or shock is a concern. The Thermal I.V. is a small, lightweight warming unit that is easily placed over a standard I.V. line to warm the fluids to 100°F. The unit is placed within 18" of the patient. Thermal I.V. features include:

- A flow rate up to 12 ml/minute
- AC- just plug in and turn on
- Electrical current stepped down to 12 volt for safety
- Adjustable hanging strap
- No separate cartridges needed
- One (1) year manufacturer warranty. Made in the USA



JOR900 Warmer unit \$470.00/ea

Bull Pen Thermal IV Warming Station

Administering IV fluids close to body temperature has become increasingly viewed as a valuable therapeutic modality. Veterinary patients, either small in size or in possible hypovolemic shock, benefit greatly from receiving warm IV fluids (~100°F) versus room temperature (70°F) fluids. However, maintaining a ready supply of warmed fluids has been difficult. The Jorvet Bullpen is an IV fluid warming station that maintains unopened IV fluid bags at a ready to use temperature of 100°F. Up to 4 one-liter bags of IV fluids can be warmed and kept ready to use. IV fluids placed on the Bullpen's top can be left for an extended period of time (weeks), warm and ready for the next patient. Simple to use, with no maintenance required, the Bullpen can be left on 24/7. The Bullpen works in conjunction with the Jorvet Thermal IV (J-900). A one-liter bag takes 2 1/2 hours to reach 90°F and 6 hours to reach and maintain 100°F.



JOR900B One-year warranty. 110V 60 Hz. 16"W x 3 1/8"H x 13 7/8"D. 5.3 lbs. \$380.00/ea

Jorvet Intrafix Air IV Set with "Y" Injection Site.



- Same drip chamber features as JOR400
- 78" soft elastic tubing
- "Y" latex injection site 6" from distal end
- Sterile

JOR400Y \$1.50/ea



Jorvet Universal Disposable IV Set

- A new IV set from Jorvet for use on either vented or non vented IV fluid containers.
- Inexpensive for best value in IV sets
- Sterile



JOR400 Sterile \$1.40/ea



Jorvet IV Set Extra Length

These sets eliminate the need for extension sets. There are 2 "Y" sites: one near the drip set and the other 8" from the distal end. Plus, there is a latex injection port at the distal end. 100" (250cm). Sterile.

JOR400A 100" (250cm). Sterile. \$1.35/ea 

Jorvet IV Set Mini-Drip Xtra Length

JOR468MA 100" (250cm). Sterile. \$1.35/ea



Jorvet Mini Basic I.V. Set

60 drop/ml. The standard IV set except has 60 drops/ml drop orifice. This is the preferred set for fine control of fluid administration to really small patients. Sterile. 68"L.

JOR468M 60 dr./ml. \$1.40/ea



Jorvet I.V. Burette Set

This IV is for small precise volumes that can be accurately measured out in calibrated burette versus 1,000ml IV fluid bags. Very useful for very small patients for accurate dosing.

JOR468B \$3.00/ea 



Jorvet Large Bore Fluid Transfer Set

Suggested for equine IV use. Large bore makes for faster administration of solutions. Short tubing is ideal for a standing horse. Sterile.

JOR466 30"L. \$4.80/ea



Jorvet Large Bore IV Set

The Jorvet large-bore IV set is a simple design for the rapid administration of solutions to large animals. Twice the diameter of conventional IV sets, the large bore increases the flow rate by a factor of 16 over standard human IV sets. Sterile.

JOR400X 72" tubing. \$5.40/ea



Jorvet Large Volume IV Solution Bag

New collapsible bag with large-size drip chamber for use with concentrates of lactated ringers. For rapid infusion of large volumes.

JOR400P 3 liter \$24.90/ea

JOR400Q 6 liter \$21.30/ea



13822 WEST BOULTON BLVD. METTAWA, IL 60045

WWW.SHOPMEDVET.COM

Phone 800-544-7521

209

Fax 800-204-2177

Equipment & Furnishings

Stainless Steel Buckets and Feed Bowls



Stainless Steel Kick Bucket

Heavy-duty stainless steel frame. Rubber ball bearing 2" casters. 360 degree bumper on frame. 14 1/2" D x 12" H with bucket.

| | | |
|---------|----------------------|-------------|
| JOR808 | Bucket and frame Kit | \$156.00/ea |
| JOR808F | Frame Only | \$110.00/ea |



Stainless Steel Pails With Handle

Stainless Steel is corrosion resistant. Pails are heavy-duty for everyday use. Cleans and disinfects easily. They will keep their bright shine new look, and are dishwasher safe.

| | | |
|---------|------------------|------------|
| JOR805A | 64oz (2 quart) | \$11.40/ea |
| JOR805B | 128oz (4 quart) | \$15.75/ea |
| JOR805C | 192oz (6 quart) | \$23.70/ea |
| JOR805D | 288oz (9 quart) | \$31.50/ea |
| JOR805E | 416oz (13 Quart) | \$37.50/ea |



Regular Stainless Steel Bowls (A)

Stainless Steel is corrosion resistant, plus almost chew-proof. They are heavy-duty for everyday use. Cleans and disinfects easily. They will keep their bright shine and new look, and they are dishwasher safe. Standard shape, no sharp edges. 9-gauge thickness, 6-gauge on larger bowls.

| | | |
|---------|---------------------|------------|
| JOR802A | 8oz (1/2 pint) | \$2.10/ea |
| JOR802B | 16oz (1 pint) | \$2.50/ea |
| JOR802C | 32oz (1 quart) | \$3.60/ea |
| JOR802D | 64oz (2 quart) | \$4.10/ea |
| JOR802E | 72oz (2.5 quart) | \$5.10/ea |
| JOR802F | 96oz (3 quart) | \$6.15/ea |
| JOR802G | 160oz (5 quart) | \$7.05/ea |
| JOR802H | 240oz (7 1/2 quart) | \$13.50/ea |
| JOR802J | 320oz (10 quart) | \$19.00/ea |



A

Heavy Duty Stainless Steel Bowls (B)

Stainless Steel is corrosion resistant, plus almost chew-proof. They are heavy-duty for everyday use. Cleans and disinfects easily. They will keep their bright shine and new look, and they are dishwasher safe. Standard shape, no sharp edges. Gauge is 50-100% thicker than the regular bowls.

| | | |
|---------|-----------------|------------|
| JOR803A | 16oz (1 pint) | \$4.90/ea |
| JOR803B | 32oz (1 quart) | \$6.20/ea |
| JOR803C | 64oz (2 quart) | \$8.30/ea |
| JOR803D | 96oz (3 quart) | \$10.90/ea |
| JOR803E | 128oz (4 quart) | \$16.05/ea |



B

Non-Tip Stainless Steel Bowls (C)

This heavy-duty bowl features a wide diameter and protective rubber cushion, making it more difficult for animals to tip or knock over the bowl. Less chance for messy water and food spills.

| | | |
|---------|----------------|-----------|
| JOR804A | 8oz (1/2 pint) | \$3.60/ea |
| JOR804B | 16oz (1 pint) | \$4.80/ea |
| JOR804C | 32oz (1 quart) | \$7.50/ea |
| JOR804D | 64oz (2 quart) | \$8.40/ea |



C

Straight-Sided Pail

12-quart stainless steel with handle. This pail takes up less storage space than conventional pails.

| | | |
|---------|-----------|------------|
| JOR398S | 13 quarts | \$69.00/ea |
|---------|-----------|------------|



JorVet

Double Diners

Double-Diner lift out bowls nest in vinyl-coated wire holders. Allows dogs to easily eat without having to chase their bowls. Legs have rubber feet to protect floors. Available in fixed or adjustable height models.

| | | |
|-------|--------------------------|------------|
| CPSF5 | 1/2 Pint Bowls | \$4.00/ea |
| CPSF1 | 1 Pint Bowls | \$4.50/ea |
| CPSF2 | 1 Quart Bowls | \$6.00/ea |
| CPSF3 | 2 Quart Bowls | \$7.50/ea |
| CPSF4 | 3 Quart Bowls | \$9.00/ea |
| CPSF9 | 3 Position 2 quart bowls | \$25.00/ea |



13822 WEST BOULTON BLVD. METTAWA, IL 60045

Phone 800-544-7521

210

WWW.SHOPMEDVET.COM

Fax 800-204-2177

Equipment & Furnishings

Instrument Trays & Stands



Mayo Tray (A)

Fits item# JOR807 and JOR807D

49-363 19 1/8" x 12 5/8" x 3/4" \$41.60/ea

Mayo Tray (B)

Top: 13 3/4" x 10" x 2/3". Bottom: 11 3/4" x 7 1/2" x 2/3".

JOR397 14" x 10" x 2/3" \$33.00/ea

Instrument Tray (C)

Stainless Steel Hospital Ware is manufactured to the exacting standards of the healthcare industry. Every product is manufactured using seamless technology, which eliminates areas that can harbor bacteria growth. All utensils are manufactured of 18-8 nickel-bearing stainless steel to prevent rust, and polished to a mirror finish.

49-365 10" x 6 1/2" x 3/4" \$17.90/ea
 49-367 15" X 10 5/8" X 3/4" \$31.90/ea
 49-368 17" X 11 5/8" X 3/4" \$41.16/ea

Instrument Tray, Strap Handle (D)

Instrument Tray with strap handle on lid. Top: 12" x 8 1/4" x 2 1/4". Bottom: 10 1/2" x 6 1/4" x 2".

JOR393A 10" x 6 1/2" x 2" \$35.70/ea
 JOR393B 12" x 7 3/4" x 2 1/4" \$36.00/ea

Stainless Steel Replacement Tray

JOR807T 19" x 12 1/2" x 3/4" Mayo Tray Only \$78.50/ea

Not Pictured

Instrument or Spay Pack Tray (E)

Below trays without lids. **JorVet**

JOR399A Top: 10 1/4" x 6 3/4" x 2". Bottom: 9" x 5 1/2" x 2". \$28.50/ea

JOR399B Top: 12" x 7 3/4" x 1 15/16". Bottom: 10 1/2" x 6 1/4" x 2". \$33.75/ea

Catheter and Instrument Tray with Flat Cover (F)

49-361 12 1/4" X 7 3/4" X 2 1/4" \$38.25/ea

Catheter and Instrument Tray with Dome Cover (G)

49-369 8 3/4" x 3 1/4" X 1 1/2" \$23.04/ea
 49-370 8 7/8" X 5" X 2" \$29.00/ea
 49-372 17.25" X 4.5" X 2" \$47.24/ea

Catheter & Instrument Tray (H)

JOR398 With cover, Top: 3 1/2" W x 12 1/2" L x 1 3/4" H. (32.4cm x 9.3cm x 4.4cm). Bottom: 12" x 3" x 1 3/4". \$25.50/ea
 JOR398A With cover and strap handle, 3" W x 8 2/3" L x 1 1/2" H. (22cm x 7cm x 3.8cm). \$18.00/ea

Catheter Tray

JOR398C Top: 16" x 3" x 2 1/2". Bottom: 15 3/4" x 2 3/4" x 2". \$45.00/ea

Double Post Mayo Stand (I)

Heavy rectangle base 21" x 20". Two ball-bearing rubber casters. Removable stainless steel trays. Adjustable height: 34" to 54".

JOR807D 21" x 20", Double Post \$146.00/ea

Mobile Instrument Mayo Stand (J)

Stable 5-leg aluminum base, 24" diameter Dual wheel casters. Removable stainless steel trays. Adjustable height: 31" to 50".

JOR807M 5-Leg, adj from 31" to 50" \$168.00/ea

Single Post Mayo Stand (K)

U-shaped heavy chrome base, 18" x 22". Two ball bearing rubber casters. Removable stainless steel trays. Adjustable height: 31" to 50".

JOR807 18" x 22", Single Post \$146.00/ea



Equipment & Furnishings

Stainless Steel



Tumbler (A)

| | | |
|--------|---------------------|-----------|
| 49-344 | 2 7/8" x 3 1/8" 7oz | \$5.90/ea |
| 49-345 | 3 3/16" x 4" 12oz | \$7.90/ea |

Dressing Jar (B)

| | | |
|--------|-------------------------------------|------------|
| 49-333 | 4 1/8" X 2 1/4" With Cover 1/2 Qt. | \$15.58/ea |
| 49-334 | 4 1/8" X 5 1/2" With Cover 1-1/4 Qt | \$19.13/ea |
| 49-335 | 4 1/8" X 6 1/4" With Cover 1-7/8 Qt | \$27.63/ea |

Solution Bowl (C)

| | | |
|--------|-----------------------|------------|
| 49-389 | 13 5/8" x 4 5/8" 7 qt | \$44.53/ea |
|--------|-----------------------|------------|

Sponge Bowl (D)

| | | |
|--------|------------------------|--------------|
| 49-383 | 4 1/4" x 2" 12oz | \$7.00/ea |
| 49-385 | 5 9/16" x 2 9/16" 29oz | \$9.90/ea |
| 49-386 | 6 1/4" x 2 3/4" 36oz | \$13.90/ea |
| 49-387 | 7 9/16" x 3" 64oz | \$22.50/ea |
| JOR394 | 3 1/2" x 1 1/2" deep | \$6.30/ea/ea |

Graduated Measures Cup (E)

| | | |
|--------|----------------------|------------|
| 49-355 | 3 3/4" x 4 5/8" 16oz | \$24.45/ea |
| 49-356 | 4 3/4" x 4 1/4" 32oz | \$33.65/ea |

Iodine Cup (F)

| | | |
|--------|----------------------|-----------|
| 49-341 | 3 7/16" x 2" 6 oz | \$3.96/ea |
| 49-342 | 4 3/8" x 2 5/8" 14oz | \$8.15/ea |

Ointment Jar With Handles (G)

| | | |
|--------|---------------------|------------|
| 49-348 | 3 1/8" x 2 3/4" 9oz | \$17.00/ea |
|--------|---------------------|------------|

Emesis Basin (H)

| | | |
|--------|-------------------------------|------------|
| 49-380 | 9 7/8" x 4 1/2" x 2 1/4" 26oz | \$14.52/ea |
| 49-381 | 6 5/8" x 3 1/2" x 1 1/2" 10oz | \$7.90/ea |
| 49-382 | 8 1/8" x 3 5/8" x 1 5/8" 12oz | \$11.33/ea |

Forceps Jar (I)

| | | |
|--------|-----------------|------------|
| 49-351 | 2 1/4" X 7" | \$22.30/ea |
| JOR396 | 6 1/2" x 2 1/4" | \$22.50/ea |

Thermometer Jar (J)

| | | |
|--------|---------|------------|
| 49-346 | 1" x 4" | \$13.50/ea |
|--------|---------|------------|

Thermometer Jar (K)

Stores glass thermometers. Wide base to give greater stability and avoid tipping over.

| | | |
|---------|-------------------------------------|-----------|
| JOR396A | 3 1/4"H (3.4cm x 9cm) x 1 1/3" dia. | \$9.30/ea |
|---------|-------------------------------------|-----------|

Dressing Jar (L)

1-liter capacity. 5"H (10cm x 12.7cm) x 4" dia.

| | | |
|---------|-------------------|------------|
| JOR395A | (4"d) x (5"h) | \$22.50/ea |
| JOR395B | (5"d) x (6 1/4"h) | \$25.50 |

Medicine Cup (M)

| | | |
|--------|-----------------|-----------|
| 49-343 | 2 1/8" x 2" 2oz | \$4.20/ea |
|--------|-----------------|-----------|

Shop 24 hours a day 7 Days a week
WWW.SHOPMEDVET.COM

Burton Outpatient II

Has all the features of the Outpatient Plus and more. Enhanced illumination plus it's focusable, 7000 foot candles at 24" (40% brighter). Focuses with central removable autoclavable SteriHandle™. Uses three 50-watt halogen bulbs, each with 2000 hour life. Comes with single ceiling mount.

Light shipped directly from manufacturer. Shipping charges billed at actual freight.

224122 Ceiling Mount \$2,295.00/ea

Fleximount Wall Mount Kit

Easy to install. Saves space. Allows 45" arm extension. Light mount shipped directly from manufacturer. Shipping charges billed at actual freight. Mount only. Lights are not included.

100160 Mount only \$600.00/ea

Burton AIM-50 Floor Lamp

Technical Specifications:

- Illumination: 99,000 Lux at 24", 45,000 Lux at 36 inches.
- Color temperature: 3100° K.
- Compact 20-inch/51cm diameter lighthead.
- Larger and adjustable light pattern.
- Uses three 50-watt halogen bulbs with 2000-hour bulb life.
- Extremely smooth focus mechanism with autoclavable handle in the center.
- Y-shaped lighthead promotes light pattern free of cast shadows.
- On/Off standby switch on the lighthead.

A50FL Each \$2,250.00/ea

Light, single Ceiling Mount Kit

100540 \$850.00/ea

Burton Outpatient II Dual Ceiling Light

0P216DC \$4,500.00/ea

Jorvet Animal Stretcher

This stretcher offers much more than any other conventional stretcher. It is equipped with two wheels on one end, and two carrying straps on the other end. This enables one person to move a patient. It can also be used in the conventional two-person carry. The frame is a lightweight aluminum. Stretcher is heavy-duty reinforced nylon. Three 2"-wide straps with buckles can be used to hold patient in position. 48" L x 22" W.

JOR742 up to 180lbs \$87.00/ea

Jorvet Soft Carry Stretcher

Great for injured animal transport. Absence of rigid poles allows carrying of patients in tight corners. Large size for carrying all types of patients. Six padded handles for carrying comfort. Washable nylon.

JOR742B 21" x 34" \$27.00/ea

Gleamer Floor Stand Light

All-purpose, rugged, compact halogen light. Offering 4166 footcandles, a sturdy gooseneck and superior quality components. Provides high intensity, maximum flexibility and extraordinary reliability. It's unique venting system, energy absorbing infrared exchanger and patented reflector filter coatings provide a heat-free beam in a cool, yet compact housing.

960112 Floorstand with casters \$695.00/ea

Halogen Light

You'll be able to work closely with this cool, intense light source to perform suturing, biopsies or any procedure where you need extra light. 20-watt halogen bulb with 1200 hour life provides a 5"-9" prefocused spot. 30000K color temperature. Weighted base with 4 locking casters and 24" heavy duty gooseneck for easy positioning. 3-year warranty. Light shipped directly from manufacturer. Shipping charges billed at actual freight.

152113 4 Caster Base \$768.00/ea

Circulating Warm Water Pump

Hypothermia is a constant risk for the small veterinary surgical patient. Approximately 60-70% of surgery patients become hypothermic. Recent human medical studies have proven that keeping patients warm during and after surgery can markedly improve clinical outcomes. This system places a flat comfortable vinyl blanket under the patient. Warm water is circulated throughout this blanket by a special electrical pump. This pump maintains your selection of temps (96°-107°) within 1.5°F. The pump is matched with the blanket size and material of your choice. This pump has a number of important features:

- Audible Alarm: low water, tilt
- *1 year warranty open sensor and high temperature
- Self-sealing connectors for no water leakage
- Dual thermostats for safety * Includes 8 feet of connecting hose
- 10" (h) X 7" (diameter) weighs 6lbs *Micro Processor Control
- 50 oz. Water reservoir *Digital LED Readout
- Can use tap water *Flow rate 15 gallons/hour
- 8 ft electrical cord *UL approved

JOR783X \$545.00/ea

Vital Signs Monitor

Vital Signs Monitor 300 Series is ideal for Spot Checks or Continuous Monitoring.

This full-featured monitor measures blood pressure (NIBP), pulse rate, MAP and SpO2, plus includes SureTemp® Plus thermometry for oral temperature readings in just 4 seconds. Nellcor® pulse oximetry, SureTemp® Thermometry and an integrated thermal printer are optional. Includes auto blood pressure mode, programmable alarms and built-in memory. R-232 computer interface allows you to upload data to your network or PC. Vital Signs Monitor complete with NIBP, Nellcor SpO2, SureTemp® Thermometry and Printer.

W-A53NTPe1 measures blood pressure (NIBP), pulse rate, MAP and SpO2, plus includes SureTemp® Plus thermometry for oral temperature readings in just 4 seconds \$5,900.00/ea

Equipment & Furnishings

Electrosurgical Units and Electrodes



Jorvet Electrosurgical Unit

The most affordable unit available for today's veterinary surgeon. With more than enough power for any procedure.

Features:

- 3 operating modes at the turn of a dial
- Fully filtered: smooth cutting
- Fully rectified: cutting & coagulation
- Partially rectified: Coagulation: larger bleeders
- 10 different power settings
- Wide selection of electrodes included
- Includes ground plate



| | | |
|---------|----------|-------------|
| JOR470 | 3 modes | \$810.00/ea |
| JOR470A | 220 volt | \$810.00/ea |

Bipolar converter

Bipolar mode of coagulation is especially useful in small species such as birds. It allows for a more precise and controlled coagulation, including in wet field.

JOR470B Plugs into front of JOR470 unit \$138.00/ea to convert to bipolar mode.

Power Cord Only for JOR470

JOR4700PC Power cord for JOR470 only \$18.00/ea

Ground plate
JOR47002 \$39.00/ea



Electrosurgical Unit Electrode **Jorvet**



Autoclavable. 1/16" Use only with J-470 unit NOTE: DO NOT store in liquids.

| | | | | | |
|-----------|--------------|------------|-----------|---------------------|---------------|
| JOR4700T1 | Diamond Loop | \$12.00/ea | JOR4700T5 | Fine Wire | \$12.00/ea |
| JOR4700T2 | Large Loop | \$12.00/ea | JOR4700T7 | Small Oval Loop | \$12.00/ea |
| JOR4700T3 | Small Loop | \$12.00/ea | JOR4700T9 | Ball Electrode | \$12.00/ea |
| JOR4700T4 | Heavy Wire | \$12.00/ea | JOR47003 | Electrode, set of 7 | \$69.00/ea/ea |



Reusable Electrode **Jorvet**

Autoclavable. 3/32"

| | | |
|----------|-------------------------|------------|
| JOR484A1 | Angled Fine Needle | \$51.50/ea |
| JOR484A2 | Angled | \$42.00/ea |
| JOR484A3 | Angled Sharp | \$45.00/ea |
| JOR484A4 | Angle, Ball | \$49.50/ea |
| JOR484A5 | Straight Ball | \$51.00/ea |
| JOR484A6 | Straight Needle | \$48.00/ea |
| JOR484A7 | Long Straight Ball | \$49.50/ea |
| JOR484A8 | Long Straight Needle | \$49.50/ea |
| JOR484A9 | Triangle electrode 1/2" | \$26.50/ea |



Reusable Loop Electrode

Great for removing skin tumors. 3/32", Loop. 3/8" dia

| | | |
|-----------|----------------------|------------|
| JOR484AD2 | Loop. 3/8" dia | \$42.50/ea |
| JOR484AD3 | Re-usable 1/2", each | \$43.00/ea |



Reusable Bipolar Forceps **Jorvet**

Autoclavable

| | | |
|-----------|--------------------------------|-------------|
| JOR484B1 | Fine Forceps. 5" | \$260.00/ea |
| JOR484B2 | Medium Forceps. 5 1/2" | \$260.00/ea |
| JOR484B3 | Curved Fine Forceps. 5" | \$260.00/ea |
| JOR484B4 | Curved Fine Forceps. 7" | \$260.00/ea |
| JOR484B5 | Straight Fine Forceps. 7" | \$260.00/ea |
| JOR484B6 | Bayonet Medium Forceps. 7 1/2" | \$260.00/ea |
| JOR484B7 | Bayonet Fine Forceps. 7 1/2" | \$260.00/ea |
| JOR484BC | Bipolar Cord for JOR484m | \$113.00/ea |
| JOR484MD9 | Foot pedal for bowie 1250 | \$474.00/ea |



Disposable Electrode

3/32"



| | | |
|-----------|-------------------------|------------|
| JOR484AD4 | Standard Needle. 25/box | \$68.00/ea |
| JOR484AD5 | Standard Blade. 50/box | \$88.00/ea |



Equipment & Furnishings

Electrosurgical Units, Electrodes & Nebulizer/Compressor

Bovie 2250 Digital Electrosurge Generator

A more powerful unit is needed when doing specialized endoscopy procedures like OHE's or spays. This unit will work well with Richard Wolf's Powerblade and other brands of bipolar endoscopy equipment. The increased power is the cut format: 200 watts, fulguration: 80 watts, bipolar: 80 watts. Uses the same JOR484 3/32" tips shown on the following page. 12.3"W x 16.3D x 6"H. Accessories included:

- Two disp hand pieces (JOR484mdla)
 - Autoclavable hand piece (JOR484mdlc)
 - Reusable body or ground plate
 - Five different electrodes
 - Two Electrodes - standard needle (JOR484ad4)*
 - x Three Electrodes - standard blade. (JOR484ad5)*
- Two-year warranty Optional Item: JOR484xd1 Bipolar Foot Switch



JOR484X \$5,520.00/ea

JorVet



Bovie Electrosurgical Unit Stand

JOR484TA Table Top Stand \$77.00/ea

Deluxe Electrosurgical Ground Plate and Cord

JOR484D3 \$186.00/ea

Foot Switch

JOR484D2 \$116.00/ea

Autoclavable Handpiece

Bovie 1250 autoclavable handpiece

JOR484MD1C \$48.00/ea

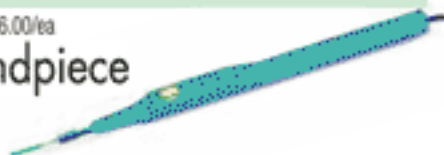

Nebulizer/Compressor

Aeromist® Plus Nebulizer Compressor: Get a high quality nebulizer without the high cost. This new sleek design is easy to pick up with break resistant hinges. It remains stable when laying flat on four non-skid rubber feet due to its low center of gravity. The compact design easily fits on small surfaces and the cord conveniently stores inside the shell when not in use.

- Electrical Requirements: 115 VAC / 60 Hz
- Power Consumption: 75 W
- Dimensions: 4.1" (105 mm) H x 5.7" (145 mm) W x 7.9" (200 mm) D; Weight: 1.6 kg (3.53 lb.)
- Sound Pressure Level: 53 dBA; Max. Comp.
- Pressure: 30 PSIG or greater
- Neb. Operating Pressure: 10 - 14 PSIG; Liter Flow Range: 4 - 8 LPM; Particle Size Less Than: 5 microns
- Maximum nebulizer solution capacity: 10 ml
- Operating Temperature: 10 C - 40 C (50 F to 104 F)
- Operating Humidity: Up to 95% non-condensing
- Storage/ Transport Temperature Range: -20 C - 60 C (-4 F to 140 F);
- Storage/Transport Humidity: Up to 95 % non-condensing.

HCS60004 Compact size with initial circuit \$45.00/ea



Deluxe Bovie Electrosurgical Unit

This is a top-of-the-line Electro surgical unit made by the original Bovie Company. They first invented the Electro surgical unit in the 1920s. The complete table top unit is fitted with veterinary specific equipment. Five modes: cutting, cutting/coagulation, coagulation, fulguration, bipolar. User has option of handpiece finger switch or foot control

- Rotary dial operates power; shown in 1 watt increments via LED readout
- Reusable body pad (ground plate)
- Built-in bipolar (requires optional foot pedal)
- Five 3/32" electrodes; interchangeable with other same size brands
- 101/4"W x 51/2"H x 10"D, 14 lbs.
- U.L. approved Accessories Included:
- Two Disposable Handpieces (JOR484md1a)
- Autoclavable Handpiece (JOR484md1c).



JOR484M NOTE: Bipolar forceps and cord sold separately. \$3,550.00/ea

JOR484MV 220V \$3,430.00/ea

JorVet



Bipolar Footswitch for JOR484X

JOR484XD1 \$214.00/ea



Ground Plate Cord for JOR484M

JOR484MD4 \$98.00/ea

Ground Plate Cord Only

JOR484D3C \$107.00/ea

Ground Plate Only

JOR484D3P \$89.00/ea

Triangle Electrode

Reusable. 3/32".

JOR484A11 1/8" \$26.50/ea



Diamond Electrode **JorVet**

Diamond Electrode. Reusable. 3/32".

JOR484A13 Diamond electrode 1/4" \$26.50/ea

JOR484A14 Diamond electrode 1/8" \$26.50/ea

Electrode Loop

Reusable 3/32" for JOR484 & JOR484M units

JOR484AD1 re-usable 1/4", each \$44.75/ea

JorVet

13822 WEST BOULTON BLVD. METTAWA, IL 60045

Phone 800-544-7521

215

WWW.SHOPMEDVET.COM

Fax 800-204-2177

Equipment & Furnishings

Gas Vak Systems & Accessories

Jorvet Multi-Station GasVak Unit

There is an increasing awareness among veterinarians and their staff about the health hazards of breathing waste anesthetic gases. The JorVet GasVak Scavenger system is an active unit that removes waste anesthetic gases at the pop-off valve on all anesthetic machines or from the end of a non-rebreathing system. The waste gas is then vented outside the clinic via a vacuum fan power unit.

- For facilities with more than one anesthesia location
- Ceiling outlet or balancing valve at each location
- Each anesthesia machine has a scavenger interface or atmospheric equalizer mounted on gas machine

JOR302 Unit comes complete with: \$1,290.00/ea

- Two balancing valves
- Two atmospheric equalizers

Multi-Station GasVak Unit

JOR302W Multi-Station GasVak Unit with Wall Mount Balancing Valves \$1,360.00/ea

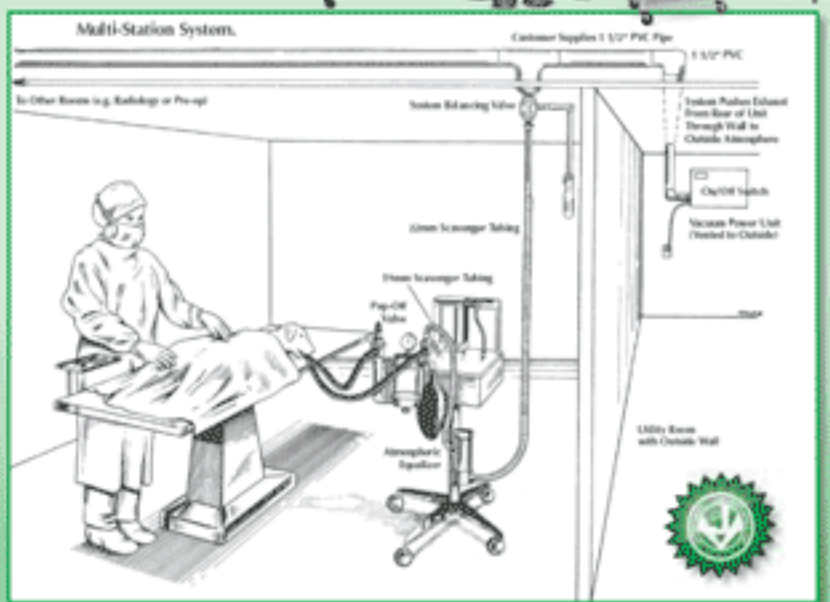

Multi-station Gas-Vaks

JOR302PLUS up to 30 stations \$1,400.00/ea

Equine GasVak System

JOR302E Equine Model \$1,079.00/ea

GasVak Motor & Housing Only

JOR302MH \$760.00/ea 

GasVak™ Active Scavenging System

JOR302R Multi-station with Remote Control. \$1,700.00/ea

Jorvet GasVak™ Scavenging System

The JorVet GasVak Scavenger System is an active unit that removes waste anesthetic gases at the pop-off valve on all anesthetic machines or from the end of a non-rebreathing system. The waste gas is then vented outside the clinic via a vacuum fan power unit.

- Mounted next to outside wall
- Up to 25' of tubing or PVC pipe can be on exhaust, allowing exit through the ceiling or going up and over another room.
- Works best with one anesthesia location and one anesthesia machine.
- Scavenger tubing provided

JOR301 Single Station \$695.00/ea 

Jorvet Gas-Vak Scavenging Tune-up Kit

- Tune-up Kit consists of:
- 22mm corrugated clear tubing, 15'.
- 19mm corrugated blue tubing, 15'.
- Four adaptors, 22mm o.d. x 22mm o.d./15mm i.d.
- Two adaptors (cuffs), 22mm o.d. x 22mm i.d.
- Two adaptors, 19mm i.d./22mm o.d. x 22mm o.d./15mm i.d.

JOR302T \$63.00/ea 



For each anesthesia station the following equipment is required.

GasVak™ Balancing Valve

JOR302D2 One per anesthesia station. \$166.00/ea

GasVak™ Atmospheric Equalizer

JOR302D1 One per anesthesia machine. \$210.00/ea

Jorvet Flowmeter

JOR302D4 \$93.00/ea

JOR302D2W

Wall Mount Balancing Valve

JOR302D2W For each anesthesia station the following equipment is needed \$209.00/ea

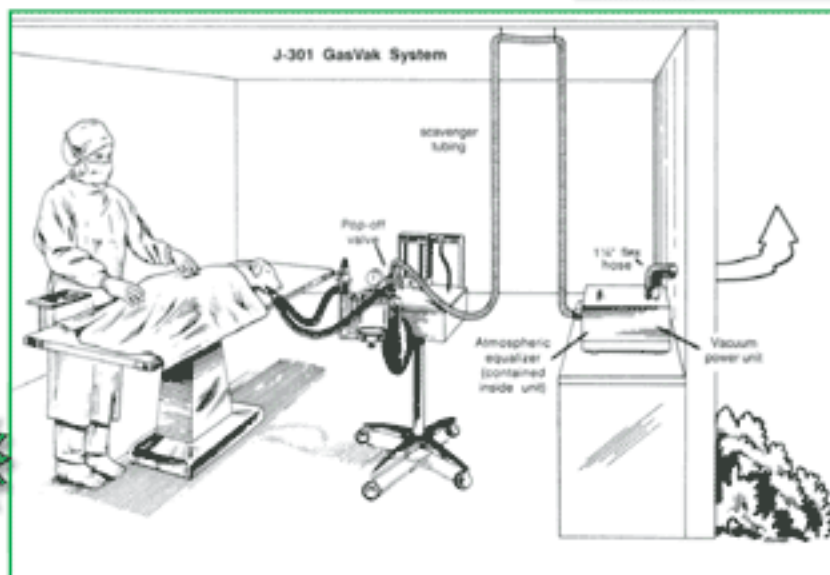

Equipment & Furnishings

Cryosurgery

Small Animal Cryo Kit

This kit uses the mini-cryogun for ease of handling. Includes three different apertures: 18mm cryochamber, 1cm flat probe, malleable extension. Mini cryogun 25cm H, 0.3kg, 0.3-liter capacity.

JOR810 \$670.00/ea

Large Animal Cryogun Kit

For use in large animal or mixed practice. Additional probes or attachments can be added as needed. Includes three different apertures: 18mm cryochamber, 1cm flat probe, malleable extension. Standard cryogun 28cm H, 0.5kg, 0.5-liter capacity.

JOR810A \$670.00/ea

Cryosurgery Accessory Items

| | | |
|---|---|-------------|
| JOR810Z | Ferret Adrenal Gland Probe. Specially designed probe for freezing adrenal gland tumors in ferrets. | \$100.00/ea |
| JOR811Q | Ladle For filling cryogun. | \$140.00/ea |
| JOR810J | Back Vent Adapter | \$28.00/ea |
| <i>Eliminates intermittent spray and increases nitrogen flow when used with small contact probes and smaller apertures.</i> | | |
| Adapt your own needles to this luer lock fitting. | | |
| JOR810U | Luer Lock Adapter | \$28.00/ea |
| Allows easy transport of cryogun with two pockets for probe storage. velcro closure. | | |
| JOR810T | | \$37.00/ea |
| An inexpensive, simple, and efficient way to extract liquid nitrogen from Dewar storage to your cryogun. NOTE: Please supply manufacturer, model number, and capacity of Dewar when ordering. | | |
| JOR811J | Withdrawal Tube | \$330.00/ea |

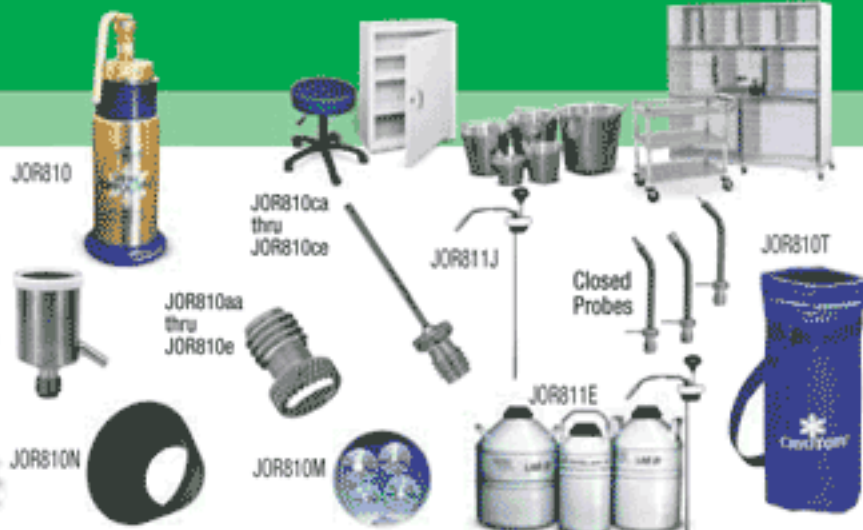

Cryogun® Spray Attachments

A transparent lexan plate with four various size conical openings. Used to concentrate spray within a limited area.

| | | |
|---|----------------------------|---------------|
| JOR810DF | Concave probe 1cm diameter | \$74.00/ea |
| A set of six neoprene cones that are used to concentrate or direct spray within a limited area. | | |
| JOR810N | Cryocones | \$121.00/pk |
| JOR810M | Cryoplate | \$50.00/ea |
| Storage Equipment. New and improved Dewar allows for longer storage of liquid nitrogen—up to 300 days. NOTE: Other sizes of Dewars available. | | |
| JOR811C | Dewar 10 liter | \$740.00/ea |
| JOR811E | Dewar 20 liter | \$1,200.00/ea |
| Allows easy transport of cryogun with two pockets for probe storage. velcro closure. | | |
| JOR810T | | \$37.00/ea |

Jorvet Opening Site Aperture.

Straight Spray Attachments. NOTE: Open spray attachments are used for lesions on patient's outside body. The bigger the aperture, the larger the volume of spray dispensed. 

JOR810AA Opening Site Aperture, 0.04" \$21.50/ea

Jorvet Straight Spray Extension

Used to reach deep recessed areas.

| | | |
|----------|--|------------|
| JOR810CA | Straight Spray Extension, 16g x 1 1/2" | \$32.00/ea |
| JOR810CB | Straight Spray Extension, 18g x 1 1/2" | \$32.00/ea |
| JOR810CC | Straight Spray Extension, 1 1/2" x 20g | \$32.00/ea |
| JOR810CD | Straight Spray Extension | \$53.00/ea |
| JOR810CE | Bent-Tip Spray Extension, 20g x 3" | \$57.00/ea |

Jorvet Cryochamber

Permits precise confined spray. Liquid nitrogen pools over deep lesions. Suggested use with malleable extensions (e.g., JOR810ra)

| | | |
|----------|-------------------|------------|
| JOR810DB | Cryochamber, 10mm | \$69.00/ea |
| JOR810DC | Cryochamber, 15mm | \$69.00/ea |
| JOR810DD | Cryochamber, 18mm | \$69.00/ea |
| JOR810DA | Cryochamber, 6mm | \$69.00/ea |

Jorvet Conical-Shaped Closed Probe

These probes are inserted into large or ulcerated lesions, thereby markedly increasing the surface area of the freeze. Closed Probe. Only the tip is cooled via a hollow tube down the probe. A side port vents the liquid nitrogen. 

| | | |
|----------|---|------------|
| JOR810EA | Conical-Shaped Closed Probe, 1mm | \$75.00/ea |
| JOR810EB | Conical-Shaped Closed Probe, 2mm | \$75.00/ea |
| JOR810EC | Conical-Shaped Closed Probe, 3mm | \$75.00/ea |
| JOR810ED | Conical-Shaped Closed Probe, 4mm | \$75.00/ea |
| JOR810EF | Conical-Shaped Closed Probe, 5mm | \$75.00/ea |
| JOR810EG | Conical-Shaped Closed Probe, 6mm | \$75.00/ea |
| JOR810EH | Conical-Shaped Closed Probe, Sharp Pointed Conical Closed Probe | \$76.00/ea |

Flat Closed Probe

Circular, and useful for wide flat lesions (e.g., squamous cell carcinoma and sarcoids). 

| | | |
|-----------|-------------------------------|-------------|
| JOR810FA | Flat Closed Probe, 1.0cm dia. | \$75.00/ea |
| JOR810FB | Flat Closed Probe, 2.0cm dia. | \$90.00/ea |
| JOR810FC | Flat Closed Probe, 2.5cm dia. | \$102.00/ea |
| JOR810FD | Flat Closed Probe, 3.0cm dia. | \$120.00/ea |
| JOR810GL | Neurectomy Probe | \$150.00/ea |
| JOR810GLA | Neurectomy probe for 16oz. | \$150.00/ea |

Jorvet Mini Closed Probe

Used to treat eyelid margin and corneal lesions. Gently curved to allow visualization and precise control.

| | | |
|----------|---|------------|
| JOR810GA | Mini Closed Probe, 1mm | \$84.00/ea |
| JOR810GB | Mini Closed Probe, 2mm | \$84.00/ea |
| JOR810GC | Mini Closed Probe, 3mm | \$84.00/ea |
| JOR810GD | Mini Closed Probe, 4mm | \$84.00/ea |
| JOR810GE | Mini Closed Probe, 5mm | \$84.00/ea |
| JOR810GF | Mini Closed Probe, 6mm | \$84.00/ea |
| JOR810GG | Mini Closed Probe, Rectangular Mini Closed Probe, 1.5mm x 3mm | \$84.00/ea |
| JOR810GH | Mini Closed Probe, Rectangular Mini Closed Probe, 2.5mm x 5mm | \$84.00/ea |

Jorvet Palate Closed Probe.

Shaft angled at 80° for easier visualization.

| | | |
|--|--------------------------|-------------|
| JOR810HA | Palate Closed Probe, 6mm | \$115.00/ea |
| JOR810RA | Malleable extensions | \$57.00/ea |
| <i>Used with any spray tip or contact probe to change angle of spray while keeping unit upright.</i> | | |
| JOR810RB | Right Angle Adaptor | \$50.00/ea |
| <i>Shaft angled at 80° for easier visualization. </i> | | |

Equipment & Furnishings

Stools & Medical Storage Cabinets

Classic Series Medical Seating

Medical stools in classic chrome construction comprise this collection of timeless favorites. Features: Chrome base construction Easy spin/thread adjustment Steel mounting plate secures seat to 2" base rubber wheel casters. Height ranges from 19" to 25" (approx). Smooth machine screw height adjustment. Solid steel machine screw shaft. Round foot ring. 1" welded tubular frame. Stool frame is completely chrome plated. Heavy duty seat mounting plate. 14" diameter seat. 4 1/2" thick padded seat for comfort. Available in following colors: Black, Gunmetal, Dove Gray, Desert Tan, Cream, Clamshell, China Green, Emerald, Tomato, Yellow, Slate Blue, Wedgwood, Royal Blue, Mulberry, Purple Gray, Burgundy



| | | |
|----------|---|-------------|
| 2100 | w/square foot ring | \$108.00/ea |
| 2100-CC | w/square foot ring and carpet casters | \$119.00/ea |
| 2102-CC | w/round foot ring and 2" dual wheel hooded casters | \$120.00/ea |
| 2102 | w/round foot ring and 2" rubber wheel, ball bearing casters | \$120.00/ea |
| 2102SEAT | For 2102 Clinton | \$30.00/ea |
| 2192 | w/round foot ring, 4" add. Height | \$165.90/ea |

Navy Premium Pneumatic Stool w/Back Rest

5 legged pneumatic stool, easy single lever seat, height adjustment ranging from 16 1/2" to 24 1/2". Easy to clean 16" diameter seat is padded with 4 1/2" foam. The 23" brushed aluminum base is equipped with hooded dual wheel casters.

JOR809PNR \$299.00/ea **Jorvet**



Jorvet Navy Blue Laboratory Stool

5 legged pneumatic stool, easy single lever seat, height adjustment ranging from 16 1/2" to 24 1/2". Easy to clean 16" diameter seat is padded with 4 1/2" foam. The 23" brushed aluminum base is equipped with hooded dual wheel casters.

JOR809PN \$227.00/ea

Jorvet Navy Blue Laboratory Stool

JOR809PLN \$384.00/ea

Jorvet Navy Blue Stool with Back Rest

JOR809NR \$162.00

Jorvet Navy Blue Chrome Base Stool

JOR809N \$139.50/ea **Jorvet**

Treatment Cabinet

2 Doors one drawer. Heavy-duty "Bringing You Closer To Home" Brand. MDR868921 2 door 1 drawer cabinet w/casters \$1,100.00/ea

Metal Cabinet

Heavy-Duty Combination Metal Storage Drawer/Filing Cabinet. Two separate locking systems for storage area and filing drawer. Full suspension locking lateral file drawer accommodates both letter and legal hanging folders. Specify color when ordering. Bringing You Closer To Home is a registered trademark of Medline Industries, Inc. Metal Storage Drawer/Filing Cabinet

MDR907836SD 78"H x 36"W x 18"D \$1,300.00/ea

Supply Cabinet

Our cabinets are built of non-majestic stainless steel and have clear tempered glass for shelves and doors. Stainless steel shelves are also available as an option. Bringing You Closer To Home is a registered trademark of Medline Industries, Inc. 36"W Treatment/Storage Cabinet with two distinct sections separated by a stainless steel work surface

MPH08856 Closed Bottom, Top Glass \$9,500.00/ea



Style Line Series Medical Seating

Good looking and hard working. Style Line offers color coordinated durability to any practice or clinic. Features: Contemporary styling One-piece nylon base Three base colors: black, slate, putty Single-lever pneumatic height control "Soft Feel" laminated polyfoam cushion 19 1/2" to 25" height range (approx). Easy single lever pneumatic height adjustment Dual wheel nylon casters. 23" black nylon composite base. 16" diameter seat. 4 1/2" thick padded seat for comfort. Easy clean upholstery BIFMA tested base

| | | |
|--------|------------------------------|-------------|
| 2130 | Screw height adj, Black base | \$140.00/ea |
| 2135 | Pneum, Black base | \$157.90/ea |
| 2135-P | Pneum, Putty base | \$162.00/ea |
| 2135-S | Pneum, Slate base | \$162.00/ea |



Base Stool Blue Vinyl w/Black Base

This is a pneumatic height adjustable stool. Blue vinyl, base is black color. Five Caster Base.

7100BL Blue Vinyl w/Black base \$111.00/ea



Black Chrome Base Stool **Jorvet**

5 legged pneumatic stool, easy single lever seat, height adjustment ranging from 16 1/2" to 24 1/2". Easy to clean 16" diameter seat is padded with 4 1/2" foam. The 23" brushed aluminum base is equipped with hooded dual wheels casters.

JOR809B \$142.00/ea

Black Premium Pneumatic Stool **Jorvet**

JOR809PB \$242.00/ea **Jorvet**

Black Premium Pneumatic Stool w/Back Rest **Jorvet**

JOR809PBR \$310.00/ea **Jorvet**

Black Laboratory Stool **Jorvet**

JOR809PLB \$384.00/ea

Medical Storage Cabinet

Can be wall mounted or stored at work station. Durable baked-on epoxy powder finish. 2 shelves per cabinet. 2 clear acrylic windows.

| | | |
|-------|--------------------|-------------|
| 3824M | 30"W x 12"D x 30"H | \$446.00/ea |
| 3826M | 30"W x 12"D x 26"H | \$344.00/ea |



Treatment Procedure Cart

Lockable drawers. Swivel casters- 2 locking. Storage space - 22 1/2" W x 13 1/4" D x 28 3/4" H Available in autumn white. No. 3803M: Weight: 60 lbs., Drawers: 3 - 3" No. 3805M: Weight: 65 lbs., Drawers: 3 - 3" & 2 - 5 3/4"

| | | |
|-------|----------|-------------|
| 3803M | 3 Drawer | \$533.00/ea |
| 3805M | 5 Drawer | \$578.00/ea |

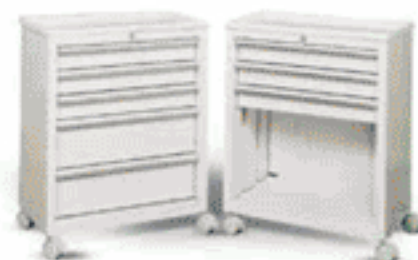

Equipment & Furnishings

Narcotic Cabinets



Narcotic Cabinet **Jorvet**

A narcotic cabinet keeps scheduled drugs safe under lock and key. Our cabinet has two locks that require two different keys for added security. The cabinet also meets DEA guidelines.

- 18g steel in powder-coated beige
- Double lock that has a separate key for each lock
- Spring clip catch keeps door closed
- Can be mounted on a wall or stand alone
- One adjustable shelf
- 56 lbs.

JOR367 24"W x 30"H x 10"D \$400.00/ea

Locking Refrigerator Storage Box

Keep your vaccines or pharmaceuticals requiring refrigeration (i.e. Propofol) safe in a secured lock box inside the refrigerator. Box dimensions 8 3/16"W x 10 7/8"D x 3 1/2"H. Easy to mount inside just about any type of refrigerator. Comes with two keys. Mounting directions.

JOR1053 8 3/16"W x 10 7/8"D x 3 1/2"H \$145.00/ea

Jorvet



Single Door Double Lock Narcotic Cabinet (A)

Perfect for areas short on space or for mobile transit of medications. 20 gauge steel 2 coded tubular cam locks. Available in autumn white.

3802M 8 3/4"W x 6"D x 7 1/4"H \$133.00/ea

Single Door Double Lock Narcotic Cabinet (B)

High security cam locks 1 position key release - will not release in open position Heavy duty 20 gauge steel 1 fixed shelf Available in autumn white

3812M 14"W x 8"D x 12"H \$322.00/ea

Double Door Double Lock Narcotic Cabinet (C)

Heavy duty 20 gauge steel. High security cam lock 1 position key. Second Door 1 adjustable shelf. Available in autumn white

3822M 12"W x 8"D x 15"H \$389.00/ea

Double Door Double Lock Narcotic Cabinet (D)

2 Adjustable shelves. Full length piano hinges. Baked enamel finish. Securely lockable. 1 fixed shelf, 2 adjustable shelves. Fully assembled- ready to use.

3821M 18"W x 8"D x 30"H \$433.00/ea

Single Door Double Lock Narcotic Cabinet (E)

Heavy 18 gauge steel exterior. 2 coded tubular cam lock for superior strength and security. 1 fixed shelf, 2 adjustable shelves. Includes mounting hardware. Available in Beige

3901M-2 23.5"W x 10.5"D x 29.5"H \$522.00/ea

Single Door Single Lock Narcotic Cabinet (F)

Heavy 18 gauge steel exterior. 2 coded tubular cam lock for superior strength and security. 1 fixed shelf, 1 adjustable shelf.

3901M 24"W x 10"D x 30"H \$478.00/ea

Single Door Single Lock Narcotic Cabinet (G)

16 gauge construction 1 adjustable shelf. High security cam locks. 1 position key release - will not release in open position. Available in autumn white. Designed to placed in-wall

3801M 14"W x 3.5"D x 10"H Storage Space \$229.00/ea
Dimensions, Overall Dimensions 16" W x 3 1/2" D x 12" H

Medical Storage Cabinet (H)

Constructed of strong 22 gauge steel. Can be wall-mounted or set under work station. Cylinder lock with 2 keys; spring clip door latch. 1 fixed shelf, 2 adjustable shelves.

3902M 30"W x 10"D x 30"H \$444.00/ea

Small Narcotics Cabinet (I)

Perfect for areas short on space or for mobile clinics. Double lock door with separate keys. Beige. **Jorvet**

JOR367S 8 3/4"W x 7 1/4"L x 6"D. 5 lbs. \$158.00/ea

Keys for JOR367 & JOR367S

JOR367K \$36.00/ea

Jorvet

Equipment & Furnishings

Stainless Steel Carts & Tables

Stainless Steel Utility Cart

These stainless steel regular-duty utility carts are durable and make for easy sanitation. Handle and leg bumpers help protect the cart, walls, corners and legs. Three shelves.

322C 18"W X 27"D X 33"H \$284.00/ea
311C 15" 1/2"W X 24"D X 32 1/8"H \$250.00/ea



Utility Cart

This utility cart features three adjustable heavy-duty grid shelves. Handle and leg bumpers help protect the cart, walls, corners and legs. 550 lbs. max. capacity. Measures 18" x 30" x 33 1/2" high. Chrome-plated. No tools required for assembly!

18306 3 Wire Shelves \$119.99/ea



Gurney

This unit is made of 18 gauge medical-grade stainless steel. Casters are 5" and two come with brakes. Solid and sturdy enough for transferring patients or for moving supplies and

PLSST40 48"W X 24"D X 36"H \$1,115.00/ea



Surgery Table

The high-tech design of our Stainless Steel Surgery Tables provides added support and stability. The 18 gauge top is die-formed from one solid piece of stainless steel and is polished to a smooth satin finish. Raised edge provides anti-drip top and drain hole on the end has a hook for collecting pail. Tie downs on each side of table provide for easy position of patient. Specifically designed for operating ease and suited with a tilt top mechanism. Top measures 22" x 60". 13 quart bucket not included.

EL9000 Electric \$2,225.00/ea
VL9020 Hydraulic \$1,855.00/ea



Gel Foam Cushion

This high-resilient foam cushion is embedded with a pressure reduction gel bladder to equalize weight and pressure distribution. The core is made with a proprietary designed gel bladder encased in high resilient polyurethane foam. The casing is a high density durable foam providing support and comfort. A zippered, navy, fluid resistant, nylon cover with urethane backing and a nylon reinforced grey, vinyl bottom; durable, wipeable and easy to care. 16"x16"x2".

MSCPRC21616 16"x16" \$41.31



Medication Cart

Medline Medication Carts Combine Security and Mobility to Keep Medications Where They're Needed. Medline's medication carts utilize a Best® solid brass interchangeable mechanism to keep medications secure. A narcotic lock is standard for dual-locking requirements. Carts have storage capacity for additional supplies. Bringing You Closer To Home is a registered trademark of Medline Industries, Inc. Medline 24-Bin Medication Cart Includes Twenty-Four 5" Patient Bins. Overall Exterior Size 27"W x 20"D x 43"H

MPHD1WMLAC1 Twenty-Four 5" Patient Bins. Overall \$2,500.00/ea
Exterior Size 27"W x 20"D x 43"H

MPHD1WMLAC2 4 Drawer 50-3" bins \$3,200.00/ea



Exam Table

This exam table features a brushed type-304 stainless steel work surface with curved edges, heavy-duty adjustable chrome-plated steel wire shelf and 1 1/2" diameter chrome-plated steel legs with leveling foot. Comes with 4" casters. Table measures 49" x 24" x 35"H

18308 49"W X 24"D X 35"H \$249.00/ea



Stainless Steel Work Table

A sturdy all-purpose utility table of stainless steel with hemmed and rolled front and rear edges. Includes adjustable undershelf and 1 1/2" backsplash. Made from 18 gauge stainless steel.

PL304 48"W X 30"D X 36"H \$920.00/ea
PL305 60"W X 30"D X 36"H \$1020.00/ea



Table Topper

This heavy-duty light gray vinyl table mat lays over your existing table top. The Table Topper gives groomers better visibility especially with black animals. This non-slip top lifts off for easy cleaning and tub rinsing.

PLTP1 24" X 36" \$39.00/ea
PLTP2 24" X 42" \$48.00/ea

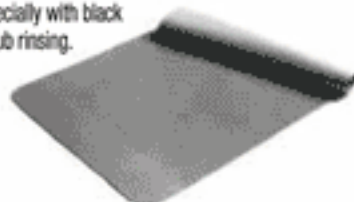

Surgery/Exam Table

A highly versatile table at an affordable price. Provides a 22" x 44" 18 gauge stainless steel top with raised edge. Height adjustable from 28" to 37" with a larger drawer cabinet. Heavy-duty chrome base revolves 360° and locks in any position. Furnished with tie downs. 5-year warranty on pump.

Natural Almond



HY1000 Hydraulic w/Tilt Mechanism and drain hole \$1,262.00/ea
HY1010 Hydraulic, Fixed-Top \$1,040.00/ea

13822 WEST BOULTON BLVD. METTAWA, IL 60045

WWW.SHOPMEDVET.COM

Phone 800-544-7521

220

Fax 800-204-2177

Equipment & Furnishings

Wet tables - Supplies Eyewash Station



Personal Eyewash Station **Jorvet**

Mount on wall to provide immediate relief. This station holds two 32 oz. dosing bottles for thorough decontamination of face and eyes. Comfortable molded eye socket opening allows full flow of solution to completely irrigate affected eye. Imprinted emergency use instructions are on each bottle and station wall. Bottles are shipped empty to fill with water or saline depending on local regulations. Securely mount station with top and bottom holes (hardware included). Measures 17" W x 4" D x 14 1/2" H.

JOR989X Wall-mount \$43.80/ea



Hair Strainer

PL500 3 1/2" Plastic

\$14⁵⁶/ea

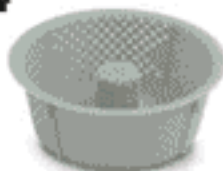

Hair Trap

PL600 PVC

\$70³⁹/ea



Pet Bath Hose

Lightweight durable 5 ft stainless steel hose and spray head. Light enough to be used all day. Spray force and pattern can be altered to work more efficiently

PL972 Spray whose \$99.00/ea

Faucet not included



Wet Table Cabinet

This multi-purpose, bi-level table/bath is available in two models and is ideal for treatment room needs. The 5" deep end is a comfortable space for bathing. Constructed of 18 gauge steel. Prep rack cover, hair trap optional. Sprayer and faucet not included.

1050-60CAB 60" x 24" x 34" Two Cabinet Doors \$2,453.00/ea

All Purpose Wet Table

All Purpose Wet Table with large knee for close-up procedures. Heavy-duty 6" deep 16 gauge stainless steel liner. Three large extension drawers, storage cabinet. Available in two colors. Prep rack cover, hair trap optional. Sprayer and faucet not included.

LTD750-48 48"L x 24"W x 36"H \$1,810.00/ea

Walk-In Stainless Steel Tub

A totally stainless steel tub. All parts are stainless steel. Great for all breeds. Fabricated with heavy 18 gauge 304 stainless steel. Swing-in swing-out 18 gauge stainless ramp. 16 gauge round tubing leg and frame assembly. Removable stainless entry allows complete view. Accommodates breeds up to 300 lbs. Available in 48" or 58" lengths. Plumbing on right or left side. Clean out hair trap. 4 back wall eye-hooks.

AQ48U 48" x 24" x 28"H \$3,109.05/ea

AQ58K 58" x 24" x 58"H \$3,208.28/ea

Wet Table with Cabinet and Drawer

This multi-purpose, bi-level table/bath is available in two models and is ideal for treatment room needs. The 5" deep end is a comfortable space for bathing. Constructed of 18 gauge steel Table has three large full extension drawers, and one large cabinet prep rack. Sprayer and faucet not included.

950-60DR 60" w x 24" d x 34" h One Cabinet Door, Four Draws \$2,068.45/ea

Omni Exam Table with Scale

Omni full flush exam table features 4-full extension drawers and a large cabinet with one adjustable shelf. Available in a choice of two laminate colors. All units are 36" high and 24" wide and are available in a variety of tops and lengths. Flush 18 gauge Stainless Steel/Digital Scale 42" Long

202-42DE 42" Stainless Steel With Scale \$2,350.00/ea

LTD750-48

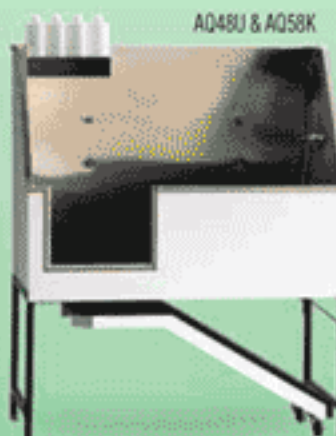

AQ48U & AQ58K

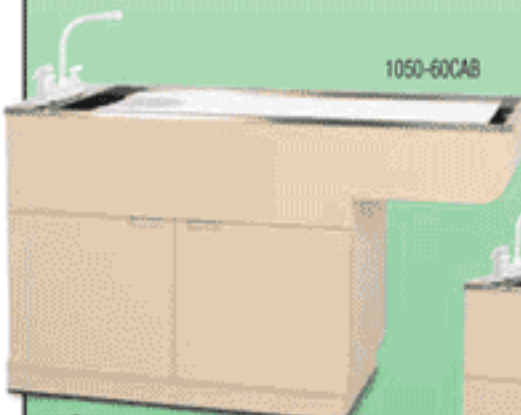

1050-60CAB



950-60DR

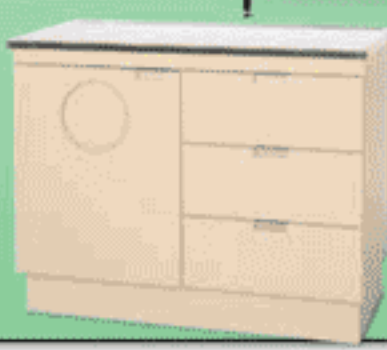

202-42DEv

13822 WEST BOULTON BLVD. METTAWA, IL 60045

Phone 800-544-7521

221

WWW.SHOPMEDVET.COM

Fax 800-204-2177

Equipment & Furnishings

Balances & Scales

Portable Digital Scale w/Stainless Tray

This scale is particularly suited to the veterinary industry. With a capacity of 44 lb (20 kg) and readability of 1/2 oz (10g), the scale will accurately weigh infants or small animals. The scale has a "Hold" feature that will capture an unstable weight and keep it on the display for recording after the weight is taken off. The scale can operate on battery (single 9VDC) or AC (adapter included) and comes with a stainless steel weighing tray.

JOR825SS \$169.00/ea

JorVet

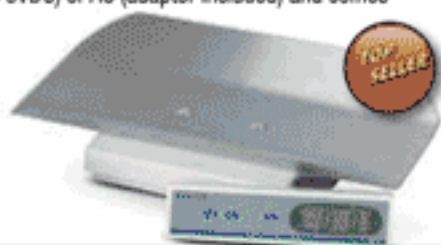

JorVet Walk-On Scale (G)

Clients love to weigh their pets on this walk-on scale. Special software will capture the weight of a moving animal. Stainless steel top with rubber mat to avoid slippage. All units are pre-calibrated and simple to install using the adjustable feet for leveling.

- Weighs Kg (0.1) or pounds (0.2) units with tare function
- Weighs up to 250 Kgs or 500 lbs
- Remote LCD display with 3 meter (10') cord for wall mounting
- 22"W x 36" L x 2"H
- AC with 4 AAA batteries

JOR825PM Has 6' Cord for Wall Mounting, 36" \$699.00/ea

JOR825GM 42" \$765.00/ea



Samson Digital Hand-held Scale

A modern scale offering all the qualities of a traditional hanging balance with the simplicity, convenience and accuracy of digital operation. Large easy to read LCD display. "Hold" feature for one person operation on heavier loads. A robust, compact and lightweight (0.95 lb/430 g) portable scale. A carrying pouch is supplied for protection when not in use. Complete with weighing handle and battery.

JOR826Q 10 kg x 0.01 kg (22 lb x 0.02 lb/1/4 oz) \$114.00/ea

JOR826R 25 kg x 0.02 kg (55 lb x 0.05 lb/1/2 oz) \$114.00/ea

JOR826S 45 kg x 0.05 kg (99 lb x 0.1 lb/1 oz) \$142.00/ea



Triple Beam Pan Balance

- Weighing Units: grams
- Readability: 0.1 g
- Capacity: 610 g (without attachment weights)
- Beam Calibrations: 10 x 0.1 g / 100 x 10 g / 500 x 100 g
- Dimensions: scale — 18" (L) x 3" (W) x 5.5" (H)

JOR826X Weighing Platform — 6 diameter (round) \$120.00/ea



Elite Floor Standing Electronic Scale

Elite Floor-Standing Lateral, Regal 300 Electronic Scale Lift Table

12661-01-GZLWEF \$3,650.00/ea



Equine Platform Weighing Scale

A horse's weight is important to the veterinarian as well as the horseman. This horse weighing scale is the most accurate available. The scale weighs horses up to 1000kg in increments of 0.2kg. Software features animal averaging to ensure accurate weighing even if the horse is not standing perfectly still on the robust walk-on platform (200cm x 100cm x 8.1cm). Complete with rubber mat for durability, safety and noise reduction and a rechargeable battery-powered indicator with backlit display.

JOR825E (200cm x 100cm x 8.1cm)

\$2,300.00/ea

JorVet Walk-On Scale

JOR825PB Battery only for scale.\$50.00/ea



Pocket Balances

This elegant-looking product offers unparalleled weighing performance, with the advantage of low cost and affordability. Standard features include grams, ounces, pennyweights and troy ounce weighing modes, parts counting and auto power off to enhance battery life. Offered in a stylish and tough ABS case with a useful top plate cover that protects the weighing platform from accidental damage, while doubling as a draft shield for more accurate weighing. Batteries and a multilingual user instruction manual are included.

- Modes: weighing (g, oz, dwt, ozt), piece counting, auto power off (standard 120 seconds)
- Function Keys: on/off, tare (zero), count, mode (unit switching)
- Display: 0.5" (13 mm) 7 segment LCD
- Temperature limits: 10° C to 35° C
- Power: 2 x 1.5 V AAA batteries (included)
- Dimensions scale: 5.2" x 3.2" x 0.9" (133 mm x 81 mm x 23 mm)
- weighing platter: 2.4" x 3.0" (61 mm x 75 mm)
- Weight: 0.3 lbs (135 g)

JOR826B 500gm \$135.00/ea



13822 WEST BOULTON BLVD. METTAWA, IL 60045

Phone 800-544-7521

222

WWW.SHOPMEDVET.COM

Fax 800-204-2177



Pet Cage Systems

This cage comes with heavy-duty hinges, removable cage doors for easy cleaning and are made of 3/4" moisture resistant marine plywood with a protective stainless steel molding. Features an advanced latching system that allows for single hand operation of cage doors. Surfaces are fully laminated and have stainless steel moldings for easy cleaning. Trim available in black, dove grey and white. Large 4" heavy-duty casters rotate 360°. Unit sizes below.

Single Units

| | | |
|-------|--------------------|-------------|
| SSAC1 | 18"W x 18"H x 24"D | \$307.04/ea |
| SSBC2 | 24"W x 22"H x 24"D | \$367.64/ea |
| SSCC3 | 36"W x 30"H x 24"D | \$519.14/ea |

Cage Systems

| | | |
|-------|--------------------------------|---------------|
| SSDD4 | 30"W x 36"H x 24"D | \$519.14/ea |
| SSC1 | 4 SSC3 Units | \$2,078.58/ea |
| SSC2 | 4 SSAC1, 3 SSBC2, 2 SSC3 units | \$3,378.00/ea |
| SSC3 | 6 SSBC2 units | \$2,205.84/ea |
| SSC4 | 6 SSBC2, 2 SSC3 units | \$3,245.13/ea |
| SSC5 | 16 SSAC1 units | \$4,940.92/ea |
| SSC6 | 9 SSBC2 units | \$3,308.76/ea |



Banked Cage

These fiberglass cage units are white and come complete with a roller base, floor grates and a unique latching system. Basic unit measures 61" wide x 26" deep x 74 1/2" high. Total shipping weight is 350 lbs. Pans and feeder doors not included.

| | | |
|-------|--|---------------|
| 126W4 | Four Cages Two rows of two 30x30x240 | \$2,359.80/ea |
| 126W5 | Five Cages One row of two 30x30x240 One row of three 20x20x240 | \$2,468.85/ea |
| 126W8 | Eight Cages Two rows of three 20x20x240 One row of two 30x30x240 | \$3,317.40/ea |
| 126W9 | Nine Cages Three rows of three 20x20x240 | \$2,771.85/ea |

Banked Cage Trays

Accessory Trays are made from easy to clean, durable plastic. Designed to fit Banked Fiberglass Cages.

| | | |
|-------|---|------------|
| 126LT | Plastic Tray For 30" x 30" Cages, Crate weight 5lbs | \$35.00/ea |
| 126ST | Plastic Tray For 20" x 20" Cages, Cage 3lbs | \$23.50/ea |

Equipment & Furnishings

Cages & Misc Supplies



Multi Unit Cage

This one-piece chrome-plated cage comes with six sections measuring 24" x 24" x 24". Features six 2' x 2' galvanized pans, one-hand operating latch, bright plating and sturdy casters for mobility. Entire unit measures 48" wide x 24" deep x 72" high. Total shipping weight is 219 lbs and comes in two containers. Floor grates available in a one pack or six pack, and are made of 4- & 9-gauge wire with 1/2" to 1 1/2" openings. Grates are sold separately.

- W67 • 6 Cage Unit \$712.00/ea
- Six heavy-duty, galvanized steel pans
- 4 & 9 Gauge Wire
- Folds flat for storage

Multi Unit Cage Floor Grates

- W67G 6/tbx \$202.50/tbx
- W67G-S Each \$33.00/ea

Jorvet Cage Card Holder

Stainless steel card holder that fits most brands of stainless steel cages by sliding tightly onto cage bars

- JOR461X Stainless Steel ID Card Holder Standard 3 x 5 \$6.00/ea

Multi Cage Adapter Kit

The multi-cage adapter kit reduces cage-drying power requirements to only 3 1/2 amps per cage. Includes three lightweight, durable, heavy-duty 8" (4" dia.) hoses to accommodate three cage locations, snout adapter, three cage attachments and clamps. Fits Sahara HP Turbo Dryer. *Adapter only, Sahara Dryer sold separately.



- F202 Fits Sahara HP Turbo Dryer only \$225.00/ea

Coated Cage Rack

PVC-coated expanded metal floor racks are a must for animal comfort and hygiene. The racks are dipped in plastisol for a uniform 1/8" coating. The diagonal grid is easy to clean with virtually any disinfectant. This coating gives the patient a softer and drier resting place while under your care. The racks are elevated 3/4" allowing the patient to remain dry and clean. Guaranteed against breakage for 3 years. Fits Shor-Line®, Surburban® and VSSI cages.



Jorvet

- JOR840P 15" x 27 3/4", 9 lbs. For 18" cage. \$81.00/ea
- JOR8400 21 1/4" x 27 3/4", 13 lbs. For 24" cage. \$87.00/ea
- JOR840R 25 3/4" x 27 3/4", 16 1/2 lbs. For 30" cage. \$105.00/ea
- JOR840S 32" x 27 3/4", 20 1/4 lbs. For 36" cage. \$136.00/ea



Paper Towel Dispenser

These paper towel dispensers measure 12 1/8" x 5 1/8" x 14 3/8" tall and are available in painted white, chrome and stainless steel. Can be used with multi-fold paper towels. C-chrome, S-stainless steel, W-white enamel.

- PTD-C Chrome Finish \$48.00/ea
- PTD-S Stainless Steel Finish \$69.00/ea
- PTD-W White Enamel Finish \$39.00/ea



Multi-Fold Towel

Multi-fold towels, 9.25" x 9.25", 4000/cs, various manufacturers.

- P-TOWEL White \$22.00/cs

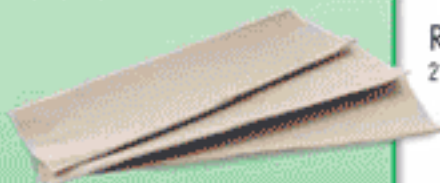

Paper Towel C-Fold

High-quality single towels help prevent waste and cross-contamination.

- TOWEL-CFOLD 2400/Case C-Fold \$27.85/cs



Roll-Around Caddy

Constructed of high-intensity injection molded polystyrene plastic. Features four hooded casters and five removable storage bins that can be hung on top of the cart from either side.

- PL275A Tool Panel for PL2175 \$89.76/ea
- PL2175 12.75W" x 15.50" x 35H" \$270.00/ea

Roll Caddy W/Door Lock

- 2176 \$357.00/ea



Equipment & Furnishings

Video Oscopes & Accessories

Video Oscope System

Rod lens scope offers a great image for viewing the ear canal, oral cavity or other body areas (i.e., the vaginal tract).

JOR6950M \$11,281.25/ea 



Illumination Cable

JOR695EC \$252.00/ea

Jorvet Video Oscope

Rod lens scope offers a great image for viewing the ear canal, oral cavity or other body areas (i.e., the vaginal tract). 5mm Scope with a 2mm channel that has a luer fitting, and a removable ear cone attachment.

JOR695E 3mm, Fully soakable. \$1,740.00/ea

Jorvet Endoscope

JOR511 2.7mm x 18cm \$2,700.00/ea 

JOR511A Sheath 4mm with Stopcock \$350.00/ea

JOR511B Trocar/Obturator \$85.00/ea

Jorvet Operating Sheath

JOR511S 2.7mm with channel \$700.00/ea

Jorvet Light Guide Cable

JOR511C 3.5mm x 180cm \$325.00/ea

Jorvet Biopsy Forceps

JOR511BFA Flexible for 2.7mm Scope \$130.00/ea

Jorvet Rigid Biopsy Forceps

JOR511BR 3mm cup \$510.00/ea

Flexible Biopsy Grasper for 2.7mm scope

JOR511GFA 2.7mm; for flexible 2.7 scope \$130.00/ea

Flexible Endoscope Complete

All endoscopes include:

- Carrying/storage case
- Channel cleaning brush
- Insufflation tubing
- Suction tubing
- One-year warranty

JOR565D1 Forceps 1.8mm x 175cm \$370.00/ea

JOR566 6.4mm x 100cm Complete \$4,800.00

JOR565 8mm x 145cm, submersible \$9,800.00/ea

Jorvet Flexible Endoscope

JOR564 9.9mm x 125cm \$8,100.00/ea 

JOR566 6.4mm x 100cm Complete \$4,800.00

JOR566A 6.6mm x 100cm \$7,560.00/ea

JOR567 3mm x 87 cm \$2,280.00/ea

JOR568 14.4mm x 200cm \$10,080.00/ea

JOR568A Three Meter \$11,760.00/ea

Jorvet Basket Retrieval Forceps

JOR564D7 1.8mm x 180cm \$300.00/ea

Jorvet Basket Retrieval Forceps

JOR568D7 1.8mm x 180cm \$576.00/ea



Mini-Vid Microscope Eyepiece Camera

This is the ideal camera for watching your microscope slides on TV. The small camera slips into your microscope's eyepiece and hooks directly to any TV. Focus through remaining eyepiece. Fits all brands of microscopes and RCA plug-on end fits all TVs or VCRs.

- 400 line resolution
- Very affordable
- 110V adaptor to 12V
- 8' cord
- 3 oz.

JOR822 \$480.00/ea







Minivid 8.1 Megapixel USB Camera

- Camera, plus configured with USB port connection to the computer.
- Includes IBM and windows compatible software
- Captures images to digital file for archiving and transmission
- Client education: allows comparison of normal versus abnormal cases (i.e. semen evaluation)

JOR8220M 8.1 Megapixel \$520.00/ea 

Minivid Camera, 1.3 Mega Pixel

This is the ideal camera for watching your microscope slides on TV. The small camera slips into your microscope's eyepiece and hooks directly to any TV. Focus through remaining eyepiece. Fits all brands of microscopes and RCA plug-on end fits all TVs or VCR's. • Very affordable • 110V adaptor to 12V 

JOR822M 1.3 Mega pixel for JOR822 \$549.00/ea

MiniVid camera w/USB Connectors

- JOR822 camera, plus configured with USB port connection to the computer. 3 megapixels.
- Includes IBM and windows compatible software
- Captures images to digital file for archiving and transmission
- Client education: allows comparison of normal versus abnormal cases (i.e. semen evaluation)

Computer not included

JOR8220 With USB connector \$520.00/ea





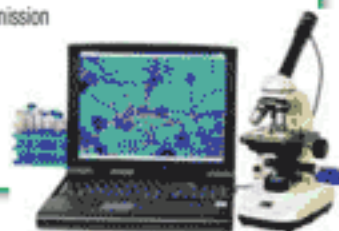

Flushing/Aspiration Pump & Bottle Assembly

JOR695XA \$660.00/ea 

Flushing/Aspiration Pump for Video Oscope

JOR695X \$353.00/ea 

Guttural Pouch Probe

JOR564D3 \$84.00/ea 

13822 WEST BOULTON BLVD. METTAWA, IL 60045

WWW.SHOPMEDVET.COM

Phone 800-544-7521

225

Fax 800-204-2177

Equipment & Furnishings

Medical Cases, Heated Blankets and pads

Mohr Medical Case

This durable heavy-duty veterinary grip helps you organize and take care of large animal pharmaceuticals and equipment. 9"W x 22"L x 12 1/2"H.

- Superb quality and craftsmanship
- Produced from durable Cyclocac material
- Manufactured since 1976
- Designed for rugged use
- Stainless steel hinges and locks
- Individual compartments fit to order
- Rudders on bottom
- Easy aseptic cleaning
- Stain resistant
- Space allowance for 100, 250, & 500cc bottles

JOR346 9"W x 22"L x 12 1/2"H \$446.00/ea



Pocket Spacer

JOR843D1 \$30.00/ea



Push Up Box for Kim Wipes®

The PUSH-UP-BOX™ has been designed to give perfect dispensing of laboratory Kimwipes. The PUSH-UP-BOX™ prevents the top most tissue from falling back into the Kimwipes box. No installation necessary. Also works with Lab wipes JOR869. Kimwipes® is a trade mark of Kimberly Clark

JOR1037 Double High Impact polystyrene, Weight 9.6 oz. \$17.50/ea

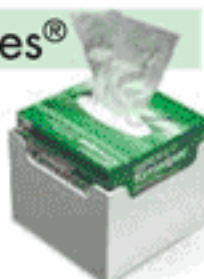

Jorvet E-Z Lift

A simple device to aid in rehabilitation or physical therapy. Any back surgery or hind limb weakness will be helped along with the use of this device. Straps can be adjusted with double-bar buckles. Washable nylon cloth.

JOR743A large \$7.65/ea
 JOR743S set of 2 \$14.25/ea
 JOR743 small \$6.60/ea

Jorvet



Jorvet Thermal Jacket

JorVet Thermal Pad is a very effective, economical source of providing warmth to retain or increase body temperature for your veterinary patients. Thermal heat is circulated by standard warming blanket placed between two sturdy sheets of 21" x 27" polypropylene 5/8" thick. This plastic pad has a smooth surface for easy cleaning and is extremely puncture resistant. This system connects to our Thermal Pump (JOR7831), and comes with connectors to adapt to other circulatory water pumps on the market.

JOR784W \$102.00/ea



Plastipad Urethane Blanket JorVet

Constructed of rugged urethane that is lightweight with extra strength that resists punctures. Seam strength is triple that of vinyl. Urethane is easy to clean.

JOR784D 12" x 18" \$218.00/ea
 JOR784E 22" x 30" \$240.00/ea



Maxitherm Vinyl Blankets

Vinyl material is less expensive but not as durable as the urethane blankets. Large. 24" x 60".

JOR784C 24" x 60" \$64.50/ea
 JOR784B 22" x 30" \$54.00/ea
 JOR784A 12" x 18" \$49.50/ea



JorVet

Y-Connector for Heating Mat

Total length 6ft. 4ft hose then Y's, 2ft length on each Y.

JOR784DC 2ft length on each Y. \$84.00/ea

JorVet



Protect-A-Pad Cover Fits

There is a widespread use of circulating hot water blankets in veterinary medicine. An animal's sharp claws can very easily puncture these blankets. These cover pads are a soft padded, quilted cotton that protects the water blanket and provides comfort for the patient. The blanket has excellent heat transference and is inserted between the pad layers with Velcro closes. Protect-A-Pads work with most brands of circulating hot water blankets. Machine washable.

JOR784Q 18" x 24" \$37.00/ea
 JOR784R 22" x 30" \$46.20/ea

JorVet

Re-usable Connecting Hose

JOR784G \$65.00/ea



Gaymar Blanket/Pump Connectors

These quick-release connectors allow connection to other brands of hot water pumps and blankets (ie., Gaymar and Baxter). All Jorvet blankets come fitted with a male connector and an extra female connector. The female connector allows a hose from any brand pump to be connected to our blanket.

JOR784X Male \$21.00/pr
 JOR784Y Set of male and female \$45.00/pr
 JOR784Z Female \$24.00/pr



JorVet



13822 WEST BOULTON BLVD. METTAWA, IL 60045

WWW.SHOPMEDVET.COM

Phone 800-544-7521

226

Fax 800-204-2177

Equipment & Furnishings

Smoke Shark, Soak Trays & Drenchers

Jorvet Smoke Shark

Noxious smoke is generated when using either an electrosurgical unit or surgical laser. At the very least smoke is a nuisance odor, and at worst, an occupational health hazard. The Smoke Shark is designed to remove smoke and particulate matter generated by electrosurgical generators or lasers at the operative sight. The Smoke Shark unit consists of a smoke evacuation power unit, filter canister, and various tubing attachments. The four stage filter captures particles down to 0.01µm with over 99.99 percent efficiency. The filter has an 18-hour shelf life and contains 24 ounces of carbon giving it superior ability to eliminate odors. Tubing (6') connects the filter to the surgery site. A small arm stand holds the tubing close to the surgical site without contaminating the sterile field. Features:

- Line voltage: 120 VAC ± 10%
- Line frequency: 50-60 Hz
- 17.78 cm (7") W x 29.85 cm (11.75") H x 46.36 cm (18.25") D
- Weight: < 6.5 kg (< 14 lbs.) w/o filter

JOR483 Complete with: \$1,960.00/ea

- Smoke Shark power unit
- Long life filter
- 6' tubing (24/pk)
- Foot switch
- Arm stand

Smoke Shark Accessories

Laser resistant Smoke Shark Wand

For laser use.

JOR483D3 Tubing, 7/8" x 6 ft. (24/pk) \$186.00/ea

Smoke Shark Footswitch

JOR483D4 \$188.00/ea

Smoke Shark Accessories

Smoke Shark power unit only

JOR483D6 \$1,410.00/ea

Smoke Shark Arm Stand

JOR483D5 \$176.00/ea



Jorvet Sink Soak Tray

A perforated tray with handles. Perfect for soaking delicate and sharp instruments after surgery. Eliminates "fishing" out sharp instruments with bare hands. Made from fiberglass reinforced plastic that can be autoclaved up to 350° F.

JOR365 Small \$69.00/ea
JOR365L Large \$84.00/ea





Endoscope Soak Trays

Most rigid endoscopes should be immersed in sterilization solution for 15 minutes before use. This tray consists of a perforated soaking basket that holds the endoscope and is lifted out after proper soaking. Made of fiberglass reinforced plastic that can be autoclaved up to 350° F. Cover included. Tray: 24" x 8" x 57/8".

- Basket: 22 1/2" x 6 3/8" x 4 3/4".
- Cover: 24" x 8" x 1/2".

JOR366 24" \$128.00/ea

JOR366L 36" \$141.50/ea





Light Source Complete

Features high intensity 150w halogen light; controlled manually by a light intensity knob. Automatic air. Factory wired to accommodate both. 

JOR569 110/220 volt \$1,050.00/ea

Metal Halide Illuminator

JOR569MH \$2,640.00/ea

Portable Light Source

This light source comes with a power cord, lithium ion battery, battery charger, and it is a LED light source. Dimensions 8" x 2 1/2". 

JOR569P 8" x 2 1/2" \$702.00/ea



Foot Operated Dispenser with Foot Pump

Blue. Remove cover to refill, capacity 28 fluid oz. (828 ml). Includes wall bracket mount for easy detachment and cleaning. Complete with 6 CE (2 meter) medical grade PVC tubing. 

JOR839 NOTE: spare parts available \$110.00/ea



Water Bottle w/ lid and Tubing for Endoscope

JOR565D7 \$210.00/ea 

Bovine Easy Drencher



The use of old wine glass bottles for drenching cattle is a thing of the past. The Easy Drencher was developed in New Zealand and is used world wide for drenching. Easy grip handle, 1.2 liter capacity/graduated in 100ml increments, 12cm long-safe nozzle, side neck for easy filling of liquid or powders. 

JOR1021 Complete \$21.60/ea

JOR1021D1 Extra Probe (only) for Easy Drencher \$10.70/ea

13822 WEST BOULTON BLVD. METTAWA, IL 60045

Phone 800-544-7521

2271

WWW.SHOPMEDVET.COM

Fax 800-204-2177

Vectra Genisys Systems



Vectra® Genisys Laser System

Large easy to read screen

- 9 cluster style 1040mW total power applicator Laser diodes at 850 nm/200mW (5) LED diodes at 670nm/10mW (4)
- Continuous and pulse operation
- Real time feedback of delivered dosages
- Ergonomically designed laser applicators conform comfortably to the hand
- Therapy can be controlled by the handheld applicator
- Protective laser eyewear IS INCLUDED!
- Two year warranty on unit, one year on laser head

JOR1013 Complete System \$4,200.00/ea

Vectra® Genisys Laser System Parts

Large easy to read screen

- 9 cluster style 1040mW total power applicator Laser diodes at 850 nm/200mW (5) LED diodes at 670nm/10mW (4)
- Continuous and pulse operation
- Real time feedback of delivered dosages
- Ergonomically designed laser applicators conform comfortably to the hand
- Therapy can be controlled by the handheld applicator
- Protective laser eyewear IS INCLUDED!
- Two year warranty on unit, one year on laser head

JOR1013D5 transport laser w/o laser applicator \$1,462.00/ea

JOR1013D6 9 Diode cluster applicator (LED & Laser) \$2,825.00/ea



Equine Vectra® Genisys Laser System

- Same features as JOR1013 small animal system
- 33 cluster style* laser applicator, 1440mW total power Laser diodes at 850nm/200mW (5) SLD diodes at 880nm/25mW and 950nm/15mW (8 + 8) LED diodes at 670nm/15mW (12)
- Two year warranty on unit, one year on laser head

JOR1013E \$4,245.00/ea

Equine Vectra® Genisys Laser System Parts

JOR1013D7 33 Diode cluster applicator \$3,136.00/ea

Therapy System Carrying Bag

Optional accessories for JOR1013

JOR1013D1 \$230.00/ea



Jorvet Intellect® Vet system

Intellect Vet is fully functional in the clinic or in an environment where mobility is a must. An optional battery module lets you perform therapy away from electrical outlets. With the optional carry bag, you can easily transport and store the unit and accessories.

- Veterinary specific software
- 5cm ultrasound applicator
- 2-channel Electro Stim package
- Ultrasound gel
- User manual
- Starter package of Dura-Stick electrodes

JOR2756K Clinical Indications* for Dogs and Horses \$3,830.00/ea

- Electrotherapy
- Muscle relaxation
- Prevention or retardation of disuse atrophy
- Increase local blood circulation
- Muscle re-education
- Maintaining or increasing range of motion
- Pain relief

Ultrasound Therapy

- Pain relief
- Relief of muscle spasm (see previous page for information on lasers)
- Relief of joint contractures

Laser Therapy Unit Optional

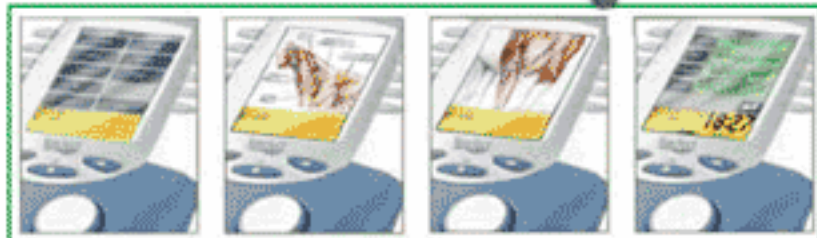

Equipment & Furnishings

Specialty Forceps, Aspiration Supplies & More



Adjustable Head Lamp

Proper lighting insures a better exam and diagnosis. This head lamp illuminates viewing area and is hands free. Focusable with standard and halogen bulbs. Operated by three AA batteries. Battery case on top of head.

JOR699 w/ head mount battery \$125.00/ea



Jorvet Aspiration Kit

A hollow tube with a luer attachment on one end. The flushing of saline allows a sample to be obtained (i.e., a tracheal wash via a syringe). Packaged sterile in tear-open pouches, complete with directions.

| | | |
|---------|---------------|------------|
| JOR727 | 2.0mm x 100cm | \$9.00/ea |
| JOR727A | 2.0mm x 140cm | \$10.50/ea |
| JOR727B | 2.6mm x 140cm | \$7.80/ea |
| JOR727C | 2.6mm x 170cm | \$8.70/ea |
| JOR727D | 2.6mm x 250cm | \$10.50/ea |



Feline Breathe Easy Inhalant Delivery System



A great aid in treating feline asthma has been improved! The "Feline Breathe Easy" has been a very popular product in treating feline asthma. The pocket spacer holds a metered dose inhaler (MDI) to deliver medication.

- The new pocket spacer is called the Vortex and has three advantages over other plastic pocket spacers:
- Anodized Aluminum chamber versus plastic. The anodized aluminum is non-electrostatic and delivers more medication from the MDI to the patient.
- 'Duckbill' shaped valve designed for minimal aspiratory effort, ensures a low loss of medication.
- Vortex Cyclonic aspiratory flow pattern enhances aerosol delivery.

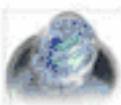

JOR843 \$37.50/ea

Jorvet Aspiration Suction Unit

This portable unit will provide powerful suction via an aspirator pump motor. Intraoperative suction of blood or body fluids. Attach to endoscope to keep field of vision clear or sample collection.

Features:

- Aspiration range 0-27" Hg
- Powerful 1/5 hp motor, most other units have only 1/10 hp
- Compact 14" L x 5 1/2" W x 10 1/2" H (35cm x 14cm x 26cm)
- In line hydrophobic filter protects motor
- 800cc Storage canister
- Lightweight, 12.4 lbs.
- Five-year warranty



JOR459 14"L x 5 1/2"W x 10 1/2"H \$350.00/ea

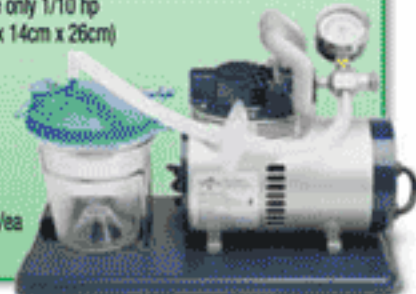

Biopsy forceps Fenestrated Cup w/Needle

JOR564D1
1.8mm x 175cm \$365.00

JOR568D1
2.5mm x 230cm \$365.00

JOR564D1A
1.8mm x 120cm \$365.00

JOR568AD2
for 3 meter scope \$365.00

JOR564D1B
1.6mm x 180cm \$365.00

3-prong grasping forceps

JOR564D2
1.8mm x 175cm \$365.00

JOR564D2B
1.8mm x 180cm \$459.00

JOR568D2
2.4mm x 225cm \$365.00

JOR564D2A
120cm x 1.8mm \$365.00

JOR568AD1
2.3mm x 330cm, for 3 meter scope \$618.00

JOR564D2B
1.8mm x 180cm \$459.00

Alligator Serrated Grasping Forceps

JOR564D5
1.8mm x 175cm \$365.00

JOR568D3
2.4mm x 225cm \$365.00

JOR564D5A
1.8mm x 120cm \$365.00

Alligator Serrated Biopsy Forceps w/ Piercing needle

JOR564D4
1.8mm x 175cm \$365.00

JOR568D4
2.4mm, 225cm \$365.00

JOR564D4A
120cm x 1.8mm \$365.00

JOR568AD3
1.8mm, 3 meter \$618.00

JOR564D4B
1.8mm x 180cm \$460.00

Rat Tooth Grasping Forceps

JOR564D6
1.8mm x 175cm \$365.00

JOR568D6
2.4mm, 225cm \$370.00

JOR564D6A
1.8mm x 120cm \$365.00

13822 WEST BOULTON BLVD. METTAWA, IL 60045

Phone 800-544-7521

229

WWW.SHOPMEDVET.COM

Fax 800-204-2177

Orthopedic Products

Cast Padding, Stockinette & Fiberglass Tape



Cast Padding

This top-quality synthetic cast padding comes rolled and sold in bags. Cast padding provides a smooth, snug, under-cast finish. Comfortably fits contours and prominences without slipping. Makes an excellent under-cast protection.

| | | |
|-----|-------------|-----------|
| CP2 | 12 rolls/Bg | \$6.00/bg |
| CP3 | 12 rolls/Bg | \$6.00/bg |
| CP4 | 12 rolls/Bg | \$6.50/bg |
| CP6 | 6 rolls/Bg | \$6.50/bg |



Cotton Cast Padding

This product is constructed of 100% pure cotton fibers to provide a soft environment under a hard cast.

| | | |
|------|------------------|------------|
| CCP3 | 3" X 4 yds 12/Bg | \$8.99/bg |
| CCP4 | 4" X 4 yds 12/Bg | \$12.99/bg |
| CCP6 | 6" X 4 yds 6/Bg | \$10.25/bg |



BSN Specialist Cast Padding

Cotton and Rayon Blend for excellent absorption. Micropleated design results in conformability, protection, and ease of application.

| | | |
|------|-------------------|------------|
| 9062 | 2" x 4yd, 24/pack | \$14.25/pk |
| 9046 | 6" x 4 yds, 6/pk | \$10.50/pk |
| 9044 | 4" x 4yd, 12/pack | \$14.50/pk |
| 9043 | 3" x 4yd, 12/pack | \$9.50/pk |



Specialist Cast Padding

Made from 100% cotton fibers, Specialist® 100 cast padding is designed to provide under-cast protection and wick away body exudates while offering the comfort and breathability of pure cotton. This cast padding fits body contours without slipping, maximizing patient protection and comfort throughout the healing process.

| | | |
|------|-------------------|------------|
| 9082 | 2" X 4 yds, 24/BG | \$18.58/bg |
| 9083 | 3" X 4 yds, 12/PK | \$12.88/bg |
| 9084 | 4" X 4 yds, 12/PK | \$18.03/bg |
| 9086 | 6" X 4 yds, 6/PK | \$13.00/bg |



Jorvet X-Lite Foam Cast Padding

Light green, lightweight open-cell foam padding. Great for cast padding or protecting bony protuberances.

| | | |
|---------|---|---------|
| JOR759 | 7.5cm (3") x 2.75m (107"). 10 rolls/pk | \$28.50 |
| JOR759A | 13cm (5.2") x 2.75m (107"). 10 rolls/pk | \$40.50 |



Jorvet Cotton Stockinette

Useful for protecting extremities prior to splinting. Use as non-adhesive liner under a splint for small and large animals. Stockinette is removable and washable.

| | | |
|----------|--------------|------------|
| JOR291AC | 1" x 25 yds. | \$12.60/ea |
| JOR291BC | 2" x 25 yds. | \$13.80/ea |
| JOR291CC | 3" x 25 yds. | \$21.60/ea |
| JOR291DC | 4" x 25 yds. | \$23.40/ea |
| JOR291EC | 6" x 25 yds. | \$32.10/ea |



Jorvet Ortho Stockinette

| | | |
|---------|--------------|------------|
| JOR291B | 2" x 25 yds. | \$15.00/ea |
| JOR291C | 3" x 25 yds. | \$22.50/ea |
| JOR291D | 4" x 25 yds. | \$27.00/ea |
| JOR291E | 6" x 25 yds. | \$34.50/ea |



Stockinette

Heavyweight, premium-grade, tubular stockinette for use under and over casts. Protects skin under plaster casts. Dispenser box simplifies cutting for exact fit. Can also be used for other dressing applications. 25 yards per box.

| | | |
|-----|-------------|------------|
| SN2 | 2" X 25 yds | \$6.95/ea |
| SN3 | 3" X 25 yds | \$9.95/ea |
| SN4 | 4" X 25 yds | \$12.95/ea |
| SN6 | 6" X 25 yds | \$17.95/ea |



Orthopedic Stockinette

High-grade, unbleached, absorbent, knitted cotton is an ideal material for undercast layer. Stretches to three times its width. 1 rl/bx.

| | | |
|------|-------------------|------------|
| 9071 | 1" X 25 yds, Each | \$12.35/ea |
| 9072 | 2" X 25 yds, Each | \$28.25/ea |
| 9073 | 3" X 25 yds, Each | \$38.81/ea |
| 9074 | 4" X 25 yds, Each | \$52.06/ea |



Orthopedic Casting Tape

This strong, durable casting tape will allow for sturdy support of those casted limbs. They are easy to prepare, easy to use and very inexpensive! Orthopedic or fiberglass casting tape activates by dipping in water, then sets in seven minutes. Finished casts are lightweight, strong, porous and easily removed with cast cutter. No choice of color. 10

| | | |
|-----|------------|------------|
| FG6 | 6" X 4 yds | \$65.00/bx |
| FG2 | 2" X 4 yds | \$35.00/bx |
| FG3 | 3" X 4 yds | \$45.00/bx |
| FG4 | 4" X 4 yds | \$55.00/bx |
| FG5 | 5" X 4 yds | \$60.00/bx |



3M Fiberglass Casting Tape

A lightweight, strong and durable casting tape that combines the benefits of fiberglass casting tape with the handling ease of plaster. Made from water-activated resin which allows easier, tack-free application. No choice of color.

| | | | |
|-------|----|------------|-----------|
| 3MFG2 | 2" | \$8.50/ea | |
| 3MFG3 | 3" | \$9.50/ea | 10+\$7.90 |
| 3MFG4 | 4" | \$10.50/ea | |
| 3MFG5 | 5" | \$11.50/ea | 10+\$9.90 |



JorVet Fiberglass Casting Tape

fiberglass mesh that is impregnated with polyurethane. It is activated by submersion in water. Many competing tapes are only 3 yards long!

- Lightweight yet durable
- Waterproof
- Easily shaped
- Packaged in foil pouch

| | | |
|---------|--------------------|-------------|
| JOR574A | 2" x 4yds., 5/cs | \$40.00/cs |
| JOR574B | 3" x 4 yds., 5/cs | \$45.00/cs |
| JOR574C | 4" x 4 yds., 10/cs | \$111.00/cs |



We do not stock all Orthopedic Products. Note that Jorvet/Jorgensen brand Products have a \$10 Dropship fee, as well as extra overnight fees.

13822 WEST BOULTON BLVD. METTAWA, IL 60045

WWW.SHOPMEDVET.COM

Phone 800-544-7521

230

Fax 800-204-2177



Delta-Lite Plus Fiberglass Cast Tape

Delta-Lite Plus is a new fiberglass cast tape that combines a fiberglass substrate and advanced water activated polyurethane resin system which provides tack-free properties. The tack-free properties allow ease of application and molding using standard examination gloves.

Features and Benefits
 • Very Smooth surface - Less abrasive finished cast enhances patient comfort while it reduces clothing snags

- Excellent rigid support (immobilization) - Creates long-lasting, light weight cast
- High lamination - Creates a strong bond between layers ensuring a strong finished cast
- New resin formulation - Use exam glove of your choice. Improves unrolling tension improving ease of cast application
- Good conformability - Makes casting application easier with change of anatomy
- Outstanding molding - Produces an anatomically correct cast



| | | |
|---------|-----------------------------|-------------|
| 7345800 | 1" X 2 yds, White, 10/BX | \$46.51/bx |
| 7345801 | 2" X 4 yds, White, 10/BX | \$62.02/bx |
| 7345802 | 3" X 4 yds, White, 10/BX | \$73.64/bx |
| 7345803 | 4" X 4 yds, White, 10/BX | \$91.09/bx |
| 7345804 | 5" X 4 yds, White, 10/BX | \$116.28/bx |
| 7345845 | 2" X 4 yds, Black, 10/BX | \$62.02/bx |
| 7345846 | 3" X 4 yds, Black, 10/BX | \$73.64/bx |
| 7345847 | 4" X 4 yds, Black, 10/BX | \$91.09/bx |
| 7345860 | 2" X 4 yds, Purple, 10/BX | \$62.02/bx |
| 7345861 | 3" X 4 yds, Purple, 10/BX | \$73.64/bx |
| 7345862 | 4" X 4 yds, Purple, 10/BX | \$91.09/bx |
| 7345855 | 2" X 4 yds, Pink, 10/BX | \$62.02/bx |
| 7345856 | 3" X 4 yds, Pink, 10/BX | \$73.64/bx |
| 7345857 | 2" X 4 yds, Deep Red, 10/BX | \$91.09/bx |
| 7345831 | 3" X 4 yds, Deep Red, 10/BX | \$73.64/bx |

| | | |
|---------|-------------------------------|-------------|
| 7345830 | 2" X 4 yds, Deep Red, 10/BX | \$62.02/bx |
| 7345820 | 2" X 4 yds, Deep Blue, 10/BX | \$62.02/bx |
| 7345821 | 3" X 4 yds, Deep Blue, 10/BX | \$73.64/bx |
| 7345822 | 4" X 4 yds, Deep Blue, 10/BX | \$91.09/bx |
| 7345823 | 5" X 4 yds, Deep Blue, 10/BX | \$116.28/bx |
| 7345825 | 2" X 4 yds, Deep Green, 10/BX | \$62.02/bx |
| 7345826 | 3" X 4 yds, Deep Green, 10/BX | \$73.64/bx |
| 7345827 | 4" X 4 yds, Deep Green, 10/BX | \$91.09/bx |
| 7345828 | 5" X 4 yds, Deep Green, 10/BX | \$116.28/bx |
| 7345865 | 2" X 4 yds, Yellow, 10/BX | \$62.02/bx |
| 7345867 | 4" X 4 yds, Yellow, 10/BX | \$91.09/bx |
| 7345850 | 2" X 4 yds, Mixed Pack, 10/BX | \$62.02/bx |
| 7345851 | 3" X 4 yds, Mixed Pack, 10/BX | \$73.64/bx |
| 7345852 | 4" X 4 yds, Mixed, 10/BX | \$91.09/bx |
| 7345832 | 4" X 4 yds, Deep Red, 10/BX | \$91.09/bx |
| 7345866 | 3" X 4 yds Yellow, 10/BX | \$73.64/bx |

Jorvet Dorsi-Flex Assist

Provides light to moderate assistance for normal hind paw placement. Designed for use as a therapy aid or for daily activity. (Not to be used for dogs with severe neurological impairments.)

Uses:

- Reduces knuckling/standing on the dorsum of the paw
- Mobility aid for unstable or weak distal hind legs
- Assists with tarsal/hock flexion and digital extension
- Can be used bilaterally

Features:

- Adjustable, elastic tension straps
- Includes breathable, anti-skid, Thera-Paw boot
- Will not immobilize joints
- Lightweight
- Easy to put on/take off
- Cleans easily by rinsing with warm water



| | | |
|----------|---|-------------|
| JOR1005 | X Small Includes Thera-Paw size S/M #2 (paw 2.5"W x 3"L) and Tibial cuff up to 4.5" circumference | \$74.00/ea |
| JOR1005A | Small Includes Thera-Paw size M (paw 2.75"W x 3.5"L) and Tibial cuff up to 5.5" circumference | \$74.00/ea |
| JOR1005B | Medium Includes Thera-Paw size M/L #2 (paw 3"W x 3.75"L) and Tibial cuff up to 6.5" circumference | \$74.00/ea |
| JOR1005C | Large Includes Thera-Paw size L (paw 3.5"W x 4.25"L) and Tibial cuff up to 8" circumference | \$78.00/ea |
| JOR1005S | Kit of 4 sizes | \$220.00/ea |

We do not stock all Orthopedic Products. Note that Jorvet/Jorgensen brand Products have a \$10 Dropship fee, as well as extra overnight fees.

Orthopedic Products

Gel Cast & Splints



Jorvet Gel Cast

This pink soft cast or bandage is useful for the management of soft tissue sprains or lower leg edema. The cast is actually a bandage material that is 100 percent cotton gauze evenly impregnated with a non-hardening zinc oxide paste. Considered a primary dressing that should be covered with a secondary bandage. Rolled and packaged in individual vacuum sealed pouches. Features and benefits:

- Contains zinc oxide paste to allow bandages to stay moist and comfortable, encouraging ambulation
- Thread-locking edges that prevent unraveling
- Non-gelatin. Does not cake or harden, stays soft over an extended period of time
- No preservatives that may cause allergy or hypersensitivity
- Vacuum sealed pouch prolongs shelf life.

| | | |
|---------|--------------|-----------|
| JOR880 | 3" x 10 yds. | \$7.50/ea |
| JOR880A | 4" x 10 yds. | \$8.10/ea |



Jorvet Quick Splints (Pair)

The latest design in pre-formed splints for small animal use, this splint is made of high impact ABS plastic and is scored for individual sizing. Radiolucent. Excellent replacement for Thomas Schroeder splints. All splints come in a paired left and right leg set. REAR LEG OR TARSAL SPLINT Shaped to follow the hock contour.

| | | |
|---------|---|------------|
| JOR119X | Cats and Small Dogs, Front, Left & Right, 12" Pr. | \$12.80/pr |
| JOR119Y | Medium Dogs, Front, Left & Right, 16" pr. | \$14.80/pr |
| JOR119Z | Large Dogs, Front, Left & Right, 20" pr | \$18.40/pr |
| JOR119Q | Cats and Small Dogs, Rear, Left & Right, 9" pr. | \$10.10/pr |
| JOR119R | Medium Dogs, Rear, Left & Right, 12" pr. | \$12.25/pr |
| JOR119S | Large Dogs, Rear, Left & Right, 16" pr. | \$14.80/pr |

Jorvet Quick Splint (4 Pack)

| | | |
|----------|----------------------------|------------|
| JOR119XL | Small, Front, Left, 4 pk | \$27.90/pk |
| JOR119XR | Small, Front, Right, 4 pk | \$27.90/pk |
| JOR119YL | Medium, Front, Left, 4 pk | \$32.40/pk |
| JOR119YR | Medium, Front, Right, 4 pk | \$32.40/pk |
| JOR119ZL | Large, Front, Left, 4 pk | \$40.50/pk |
| JOR119ZR | Large, Front, Right, 4 pk | \$40.50/pk |
| JOR119QL | Small, Rear Left, 4 pk | \$21.60/pk |
| JOR119RL | Medium, Rear, Left, 4 pk | \$26.10/pk |
| JOR119QR | Small, Rear, Right, 4 pk | \$21.60/pk |
| JOR119SL | Large, Rear, Left, 4 pk | \$39.00/pk |
| JOR119SR | Large, Rear Right, 4 pk | \$39.00/pk |



Splint Rod Bender with Splint Rods

Ideal for veterinarians who wish to save money by making their own splints. 24 per case.

| | | |
|----------|------------------|-------------|
| JOR261A | 3/16" X 6" 24/cs | \$150.00/cs |
| JOR261B | 1/4" X 6" 24/cs | \$144.00/cs |
| JOR261C | 3/8" X 6" 24/cs | \$186.00/cs |
| JOR261SB | Rod Bender only | \$93.00/ea |



Sam Splints

The Sam® Splint is a closed-pore, foamed, coated, malleable aluminum product that is so unique it is patented. This lightweight radiolucent immobilization device, well-accepted in the human field, has been carefully evaluated and improved to meet the unique requirements of veterinary medicine. The Sam® Splint is the lightweight, universal veterinary splint.

- Washable, not affected by water, disinfectants or temperature extremes.
- Compact. May be stored flat or rolled.
- Easily cut with ordinary scissors.
- Radiolucent.

| | | |
|---------|-------------------|------------|
| JOR289 | 4.25" X 36", Roll | \$18.90/rl |
| JOR289P | 10/PK, 4.25" x 2" | \$19.00/pk |



Jorvet Carpal Splints

These splints are made from a heavier material that is reinforced with longitudinal ribs. A recessed area reduces pressure on a carpal pad. A slight bend in the distal end follows the natural resting position. Splints are provided with an open pore foam for comfort.

| | | |
|---------|------------------------------|------------|
| JOR650A | Toy, 7.5" X 1" X 5/8"D | \$9.00/ea |
| JOR650B | Small, 10" X 1-1/4" X 5/8"D | \$9.60/ea |
| JOR650C | Medium, 12" X 1-1/2" X 7/8"D | \$10.05/ea |
| JOR650D | Large, 15" X 1-7/8" X 7/8"D | \$11.70/ea |
| JOR650E | XL, 18" X 2" X 1"D | \$15.60/ea |
| JOR650S | Set Of 5 | \$54.00/ea |

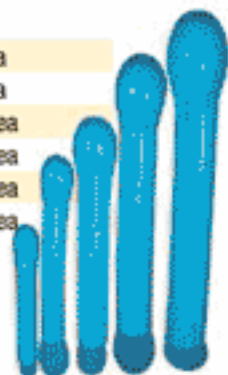

Jorvet Plastic Splints

Made of strong, light-weight plastic and padded with non-irritating foam. Can be contoured at distal end with addition of moderate heat; modified cutout for carpal pad. Radiolucent- will not interfere with X-ray while in place. Familiar green color.

| | | |
|---------|-------------------|-----------|
| JOR119A | Small 1" x 8" | \$2.10/ea |
| JOR119B | Medium 1.5" X 12" | \$2.40/ea |
| JOR119C | Large 2" X 16" | \$3.15/ea |

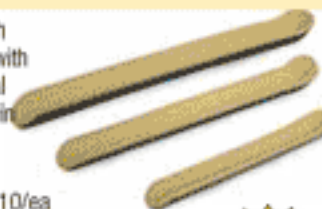

We do not stock all Orthopedic Products. Note that Jorvet/Jorgensen brand Products have a \$10 Dropship fee, as well as extra overnight fees.

13822 WEST BOULTON BLVD. METTAWA, IL 60045

WWW.SHOPMEDVET.COM

Phone 800-544-7521

232

Fax 800-204-2177

Orthopedic Products



Jorvet Splints; Orthopedic, Adjustable & Mason

Jorvet Adjustable Splints

These pre-formed "T" splints offer adjustments over a wide range of sizes. Size adjustable by a simple set screw. The bottom or distal portion of the splint is stainless steel and the upper portion is malleable aluminum. It can be bent or angled for proper fitting. The proper sizing consists of the upper circle diameter, which is not adjustable, and a lower portion, which is adjustable over a maximum or minimum length.

| | | |
|---------|------------------|------------|
| JOR657 | Front Leg Small | \$64.00/ea |
| JOR657A | Front Leg Medium | \$70.00/ea |
| JOR657B | Front Leg Lrg | \$87.00/ea |
| JOR657Q | Rear Leg X-S | \$66.00/ea |
| JOR657R | Rear Leg Small | \$63.00/ea |
| JOR657S | Rear Leg Medium | \$81.00/ea |
| JOR657T | Rear Leg Lrg | \$79.00/ea |

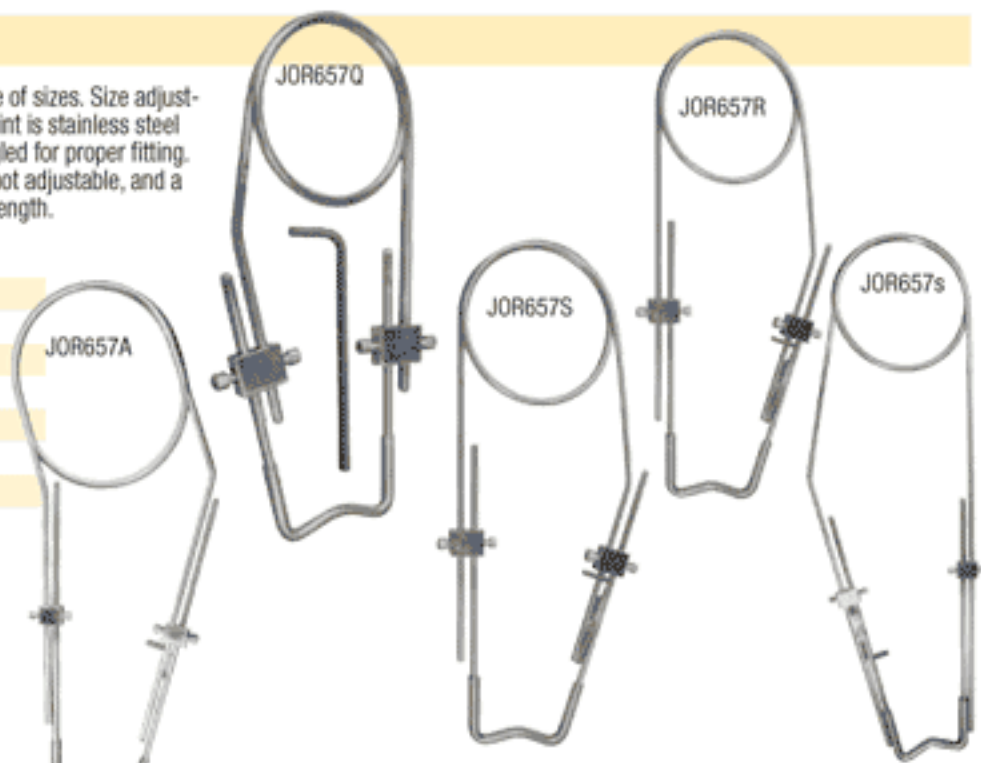

Petite Splint

This very small splint is a malleable aluminum with blue 1/4" thick foam padding. The distal tip has a slight bend to give the spoon shape. Can be trimmed to shape. 1.5cm x 11cm. 3 per package.

| | | |
|---------|--------------------|------------|
| JOR668P | 1.5cm Wx11cm, 3/Pk | \$12.00/pk |
|---------|--------------------|------------|

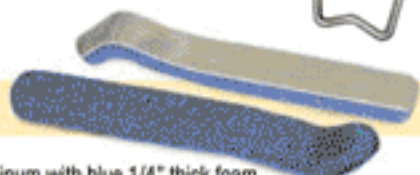

Jorvet Tail Splint

A four-finger malleable aluminum splint with blue foam padding. This splint fits over the end of the tail and is taped in place. 2" length. 3 per package.

| | | |
|--------|---------------|------------|
| JOR668 | Aluminum 3/Pk | \$12.00/pk |
|--------|---------------|------------|

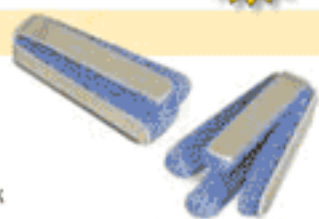

Jorvet Mason-Meta Splint

These are the original lightweight aluminum splints for lower limb injuries. These splints may be used with an extension, if a slightly longer splint is needed. These splints are reusable and designed to last.



Hema Stop Styptic Powder

| | | |
|----------|------------------------------------|-----------|
| JOR1077 | Small "pill vial" size. 14gm 0.5oz | \$4.50/ea |
| JOR1077A | Large screw cap vial. 1.5 | \$9.00/ea |



SAVE ON PET MED SUPPLIES

SHOPMEDVET.COM

- SUTURE**
Skin Staples/Tissue Adhesives
- PHARMACEUTICALS**
Ophthalmics/Antibiotics/Vaccines
- INSTRUMENTS**
Spray Packs/O.R./Goggles
- GLOVES**
Exam/Surgical/Animal Handling
- COTTON/GAUZE**
Sponges/Brown/Roll
- GOWNS**
Surgical/Rainier/Protect



| | | |
|----------|------------------------------------|------------|
| JOR651A | Toy, 1"W, 3 1/4" L | \$5.50/ea |
| JOR651B | Toy, 1"W, 5 1/4" L | \$6.00/ea |
| JOR651BX | Toy Ext, 1"W, 3 1/4" L | \$6.90/ea |
| JOR651C | Small, 1 1/4"W, 5" L | \$6.00/ea |
| JOR651D | Small, 1 1/4"W, 7" L | \$6.75/ea |
| JOR651DX | Sm Extension Ea, 1 1/4"W, 4" L | \$10.20/ea |
| JOR651E | Medium, 2"W, 7 1/2" L | \$6.90/ea |
| JOR651F | Medium, 2"W, 12" L | \$7.50/ea |
| JOR651FX | Med Extension Ea, 2"W, 6 1/4" L | \$10.20/ea |
| JOR651G | Large, 2 1/2"W, 14" L | \$7.80/ea |
| JOR651GX | Lg Extension Ea, 2 1/2"W, 7 1/4" L | \$9.00/ea |
| JOR651H | X-Large, 3"W, 16" L | \$9.00/ea |
| JOR651HX | X-L Extension Ea, 3"W, 7 1/4" L | \$9.30/ea |
| JOR651S | Splints Only | \$48.00/ea |
| JOR651X | Set With Extension | \$90.00/ea |

Mason meta-splints (4-wing nut set)

| | |
|---------|--------|
| JOR651W | \$4.50 |
|---------|--------|

We do not stock all Orthopedic Products. Note that Jorvet/Jorgensen brand Products have a \$10 Dropship fee, as well as extra overnight fees.

Marq-Easy Thermo Plastic Splints



Jorevet Marq-Easy Thermoplastic Splint Sheets

Solid construction 1/8" thick splint sheets offers superior rigidity and tensile strength (180,000 psi), making it ideal for weight-bearing splints in small and large animals (i.e., medium to large dogs, horses, and livestock). The tough, rubberbased material makes a strong, rigid splint, drapes well over contours and bony areas, and adheres to itself when heated to reinforce or patch splint. Radiolucent. Tan.

| | | |
|---------|--|------------|
| JOR940A | 4" x 9". For narrow, long legs | \$12.00/ea |
| JOR940B | 6" x 12" Sheet | \$22.50/ea |
| JOR940C | 12" x 24" Sheet | \$75.00/ea |
| JOR940F | 4" x 6" Sheet | \$9.90/ea |
| JOR940G | 6" x 9" Sheet | \$20.70/ea |
| JOR940H | 9" x 12" Sheet | \$34.35/ea |
| JOR940V | Kit includes: 1" x 36" L strap and 12" hook patch with self-adhesive back side. Both can be trimmed to customize the splint. | \$8.60ea |

Marq-Easy Thermoplastic Splint Sheets Kit

Provides all the basic components to get started with thermoplastic splinting. A wide range of applications can be accomplished with the materials provided along with the comprehensive CD R Kit includes:

- JOR940b Marq Easy 1/8" Thick Splint Sheet. 6" x 12".
- JOR940g Marq Easy 1/16" Thin Splint Sheet. 6" x 9".
- JOR940w Polycushion 1/8" Thick Padding. 18" x 24".
- JOR940x Compact Foam 3/8" Thick Padding. 16" x 24".
- JOR940s Clear Thera-Gel 1/8" Thick Sheet.
- JOR940v Soft Padded Velcro Strapping. 1"W.
- JOR940t Soft Padded Velcro Strapping. 2"W.
- JOR940cd Instructional CD ROM.
- JOR291bc Cotton Stockinette 2" x 25 yd. (also in kit)

JOR940K Starter Kit \$135.00/ea

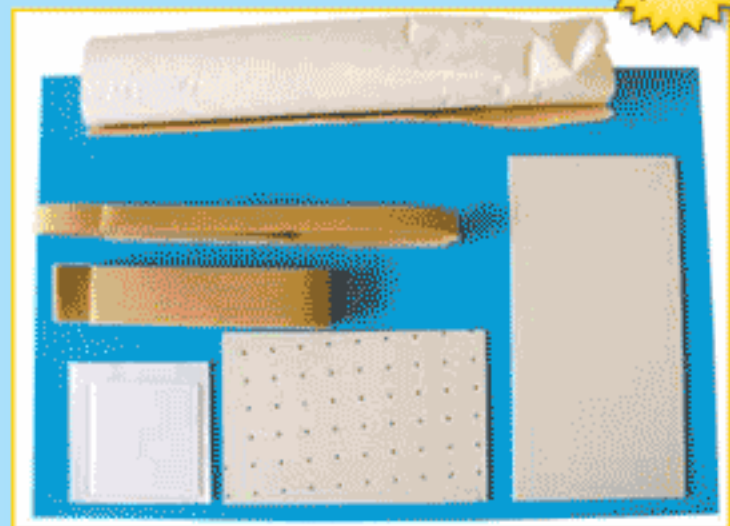

Jorvet Clear Thera-Gel 1/8" Thick Sheet

With self-adhesive back. Cut to fit to protect bony prominences and sensitive areas. Contains mineral oil to help soften and protect delicate skin. Washable with soap and water.

JOR940S Latex-free, 4" x 4". \$24.60/ea

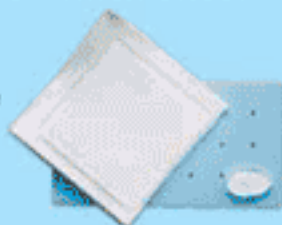

Jorvet Polycushion 1/8" Thick Padding

Self-adhesive back. Closed-cell, soft construction. Adheres to splint sheet prior to heating in water. Applying this padding on splint sheet prior to heating in water takes longer to soften (~5 minutes). For all-purpose use. Wipes clean with damp cloth.

JOR940W Latex-free. Tan. 17 3/4" x 24" \$19.50/ea

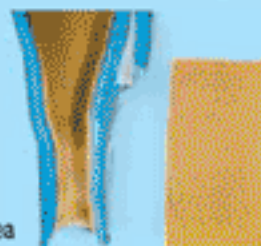

Jorvet Compact Blue Foam

With self-adhesive back. Open-cell, slow-recovery construction. Medium-density, compact foam molds with body heat to contour body parts. Use to pad the splint for increased patient comfort. Contains some latex.

JOR940X 3/8" Thick Padding (for Splints), 16" x 24" sheet \$35.45/ea



Jorvet Soft Padded Velcro Strapping

Velcro Strapping useful for larger animals or to disperse pressure over larger surface areas. Kit includes: 2" x 36" L strap and 12" hook patch with self-adhesive back side. Both can be trimmed or thinned as needed.

JOR940T 2" x 1 yd \$12.90/set



Jorvet Halpa Fleece Liner

With self-adhesive back. Open-cell, extremely softweave. Mild stretch makes it easier to line intricate spaces and contours for use with smaller animals, including small dogs, cats, birds, and exotics. Useful to pad strapping material and for covering minor creases in splints.

JOR940Y Latex-free 100% cotton. Pink. 9" x 16" \$18.75/ea



We do not stock all Orthopedic Products. Note that Jorvet/Jorgensen brand Products have a \$10 Dropship fee, as well as extra overnight fees.

13822 WEST BOULTON BLVD. METTAWA, IL 60045

WWW.SHOPMEDVET.COM

Phone 800-544-7521

234

Fax 800-204-2177



Vet-lite Sheet

This product was a popular product that was discontinued a few years ago in the veterinary field. It is now available once again. Constructed of thermoplastic white mesh. When heated in hot water, it turns into a soft malleable material that can be shaped into any configuration. Hardens as it cools.

- Can be reheated and reshaped
- Partially used material may be retained for future use
- Waterproof
- Gloves not required
- Long shelf life

| | | |
|----------|--------------------------|------------|
| JOR758SA | 3"W x 15"L. 15 sheets/pk | \$51.00/pk |
| JOR758SB | 4"W x 15"L. 15 sheets/pk | \$60.00/pk |
| JOR758SC | 6"W x 15"L. 15 sheets/pk | \$87.00/pk |

Vet-lite Cast Material

This product was a popular product that was discontinued a few years ago in the veterinary field. It is now available once again. Constructed of thermoplastic white mesh. When heated in hot water, it turns into a soft malleable material that can be shaped into any configuration. Hardens as it cools.

- Can be reheated and reshaped
- Partially used material may be retained for future use
- Waterproof
- Gloves not required
- Long shelf life

| | | |
|---------|---------------------------|-------------|
| JOR758A | 2"W x 70"L. 10 rolls/box | \$99.00/pk |
| JOR758B | 3"W x 70"L. 10 rolls/box. | \$125.00/pk |
| JOR758C | 4"W x 70"L. 10 rolls/box | \$159.00/pk |
| JOR758D | 6"W x 70"L. 10 rolls/box | \$217.00/pk |

Vet-lite



Carpo-Flex Sportswraps Light

Jorvet

Available in 3 carpal support products that vary in the degree of support that they provide. Degree of Support Scale (1-10): 1 (provides light support) – 10 (provides complete immobilization) 1) Carpo-Flex Sports Wrap: Provides light support and protection (Scale: 1 – 3). Ideal for mild strains and sprains



| | | |
|-----------|--|------------|
| JOR1004 | XS right Teal. 5"W x 3.5"H; 1.0mm neoprene; 1"W elastic straps | \$25.00/ea |
| JOR1004A | Small, Right, Red. 6"W x 5"H; 1.5mm neoprene; 1"W and 1.5"W elastic straps | \$26.00/ea |
| JOR1004AL | Small, Left, (fits small to medium dogs with up to 5.5" wrist circumference) | \$26.00/ea |
| JOR1004B | Medium, Right, Blue. 7"W x 6"H; 1.5mm neoprene; 1.5"W elastic straps | \$27.00/ea |
| JOR1004BL | Medium, Left, (fits medium dogs with up to 6.5" wrist circumference) | \$27.00/ea |
| JOR1004C | Large, Black. 8"W x 6.75"H; 2.0mm neoprene; 2"W elastic straps | \$28.00/ea |
| JOR1004CL | Large, Left (fits large dogs with up to 7.5" wrist circumference) | \$28.00/ea |

Carpo-Flex-X

Jorvet

Provides moderate support (Scale: 4 - 7). Nylon support straps can be Velcroed on any aspect of the wrap for customized support of the medial, lateral, and/or caudal aspect of the limb.

| | | |
|-----------|---|------------|
| JOR1004JL | X Large, Left | \$54.70/ea |
| JOR1004E | Xsmall, Right | \$43.75/ea |
| JOR1004EL | XSmall-Left | \$43.75/ea |
| JOR1004F | Small-Right | \$47.40/ea |
| JOR1004FL | Small-Left | \$47.40/ea |
| JOR1004G | Medium-Right | \$51.00/ea |
| JOR1004GL | Medium-Left | \$51.00/ea |
| JOR1004H | Large-Right | \$54.70/ea |
| JOR1004HL | Large-Left | \$54.70/ea |
| JOR1004L | (fits small to medium dogs with up to 5.5" wrist circumference) | \$25.00/ea |
| JOR1004J | X Large, Right | \$54.70/ea |



with nylon



NEW

Jorvet Carpo-Splint Kit

Provides heavy support to complete immobilization (Scale: 8 - 10). Thermoplastic sheet can be molded over any aspect of the wrap to produce a custom immobilizing splint. The Kit includes 1 thick, neoprene wrap, foam padding, nylon straps, thermoplastic sheet, and Velcro tabs.

| | | |
|-----------|---------------|------------|
| JOR1004M | X Small-right | \$58.32/ea |
| JOR1004ML | X Small-left | \$58.32/ea |
| JOR1004N | Small-right | \$62.00/ea |
| JOR1004NL | Small-Left | \$62.00/ea |
| JOR1004P | Medium-right | \$65.60/ea |
| JOR1004PL | Medium-Left | \$65.60/ea |
| JOR1004Q | Large-Right | \$69.25/ea |
| JOR1004QL | Large-Left | \$69.25/ea |
| JOR1004R | X Large-Right | \$72.90/ea |
| JOR1004RL | X Large-Left | \$72.90/ea |



Medial splint mold



Lateral splint mold



Palmar splint mold



with splint

We do not stock all Orthopedic Products. Note that Jorvet/Jorgensen brand Products have a \$10 Dropship fee, as well as extra overnight fees.

13822 WEST BOULTON BLVD. METTAWA, IL 60045

WWW.SHOPMEDVET.COM

Phone 800-544-7521

235

Fax 800-204-2177



Jorvet DogLeggs Adjustable

Innovative coverage solution for dog's elbows, provides comfort and protection while allowing dogs complete freedom of movement. Available in 5 sizes. The wide variety of sizes gives veterinarians the ability to comfortably fit each patient.

Therapeutic treatment of:

- Hygroma
- Decubital ulcers
- Elbow Dysplasia
- Calluses
- Arthritis
- Post-surgical coverage
- Easy to use—increases patient compliance
- Durable and machine washable
- Suitable for 24/7 use on chronic patients



DogLeggs®



| | | |
|---------|--|-------------|
| JOR746A | Small. 6 3/4" (fits 5 1/4" to 7 1/4") | \$117.00/pr |
| JOR746B | Medium. 8 1/6" (fits 7 1/5" to 9 1/7") | \$117.00/pr |
| JOR746C | Medium/Large. 10 1/8" (fits 9 1/7" to 11 1/9") | \$117.00/pr |
| JOR746D | Large. 12 1/10" (fits 11 1/9" to 13 1/10") | \$117.00/pr |
| JOR746E | Extra Large. 14 1/10" (fits 13 1/9" to 15 1/11") | \$117.00/pr |

DogLeggs Chest Strap

The Chest Strap holds DogLeggs in the correct position over the dog's shoulders. Not all dogs need one, however, many do. A chest strap is part of the purchase of each pair of DogLeggs. Due to the variety of dogs each pair of DogLeggs fits, sizing is determined at the time of purchase.

| | | |
|----------|------------------|------------|
| JOR746AS | Small, 16" | \$13.50/ea |
| JOR746BS | Medium, 18" | \$13.50/ea |
| JOR746CS | Medium-Large 20" | \$13.50/ea |
| JOR746DS | Large, 22" | \$13.50/ea |
| JOR746ES | X-large, 24" | \$13.50/ea |



Jorvet Orthopedic Surgical Pack

This Orthopedic Surgical Pack provides every piece of surgical instrumentation to get started with orthopedic procedures with an emphasis on IM pins and cerclage wires.

Includes:

- JOR214L Jacob's Hand Chuck.
- JOR250 IM Bone Pin Bag.
- JOR250n K-Wires (6).
- JOR250p K-Wires (6).
- JOR228b Osteotome.
- JOR107 Gigli Wire.
- JOR107h Gigli Wire Handles (2).
- JOR222 Bone Curette #0.
- JOR243 Senn Retractors (2).
- JOR241 Weitlaner Retractor.
- JOR159L Kern's Bone Holding Clamp.
- JOR159 Mini Kern's Bone Holding Clamp.
- JOR218 Cerclage Wire Twister and Cutter.
- JOR260b Cerclage Wire. 20g x 10mm.
- JOR260c Cerclage Wire. 22g x 10mm.
- JOR209f Forman Bone Rasp.
- JOR220ba Pin Cutter.
- JOR226q Freer Elevator.
- JOR224f Friedman Rongeur.
- JOR251b Part Threads Bone Pin. 5.64" (2).
- JOR251c Part Threads Bone Pin. 3.32" (2).
- JOR251d Part Threads Bone Pin. 7.64" (2).
- JOR251e Part Threads Bone Pin. 1.8" (2).
- JOR251f Part Threads IM Pin. 9.64" (2).
- JOR251a Part Threads IM Pin. 1.16" (2).
- JOR228m Gerzog Mallet.

| | | |
|--------|---------------|---------------|
| JOR427 | Complete Pack | \$1,068.00/ea |
|--------|---------------|---------------|

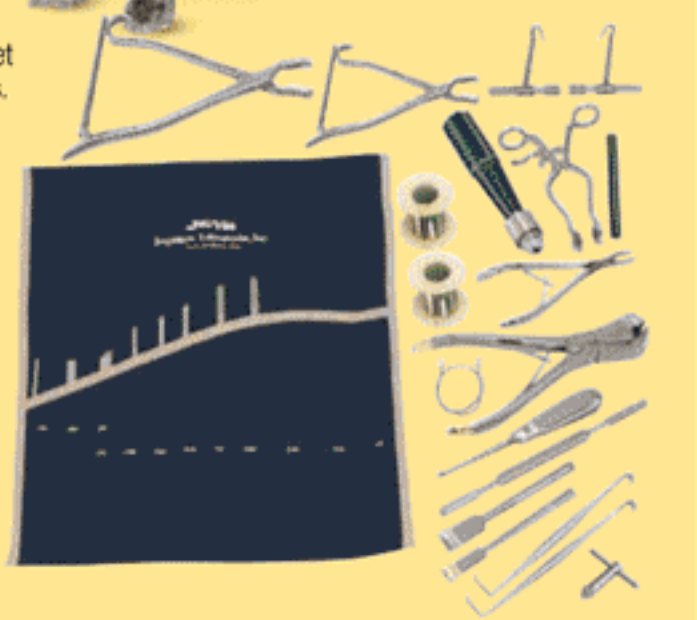

We do not stock all Orthopedic Products. Note that Jorvet/Jorgensen brand Products have a \$10 Dropship fee, as well as extra overnight fees.

13822 WEST BOULTON BLVD. METTAWA, IL 60045

WWW.SHOPMEDVET.COM

Phone 800-544-7521

236

Fax 800-204-2177



Jorvet External Fixation Starter Kit

Basic kit to provide components enough for any type I frame in small and medium size. Ideal for beginning entry into external fixation.

| | | |
|----------|--|-------------|
| JOR371K | Complete Kit | \$442.00/ea |
| JOR371S | Single Fixation Clamp, Small | \$30.00/ea |
| JOR371M | Single Fixation Clamp, Medium | \$25.50/ea |
| JOR371DS | Double Fixation Clamp, Small | \$54.00/ea |
| JOR371DM | Double Fixation Clamp, Medium | \$55.00/ea |
| JOR371PA | 3/32" External fixation pins (4) pt. thrd. | \$16.20/ea |
| JOR371PB | 1/8" External fixation pins (4) pt. thrd. | \$9.75/ea |



Jorvet Small Fixation Type I Kit

The pins of Type-I frame pass through both bone cortices. The clamps and connecting rods are assembled only on one side of the injured leg. Type-I Kit contains:

- 6 Single clamps
- 2 External fixation part thread pins
- 2 Double trocar smooth IM pins
- 1 Connecting rod

| | | |
|----------|----------------------------------|-------------|
| JOR371KS | Small, Pin, 3/32" dia. Rod, 6"L | \$149.00/ea |
| JOR371KL | Large, Pin, 5/32" dia. Rod, 10"L | \$154.00/ea |



Type-II External Fixation Kit

The pins of the Type-II configuration pass through two sides of the limb. Clamps are attached to both ends of protruding pins. Type-II kit contains:

- 4 Double trocar IM pins
- 8 Single clamps
- 2 Connecting bars

| | | |
|-----------|--------------------------------------|-------------|
| JOR371KBL | Large, IM pin, 5/32" x 10" Rod, 10"L | \$216.00/ea |
| JOR371KBM | Medium, IM pin, 1/8" x 9" Rod, 8"L | \$199.00/ea |
| JOR371KBS | Small, IM pin, 3/32" x 8" Rod, 6"L | \$199.00/ea |

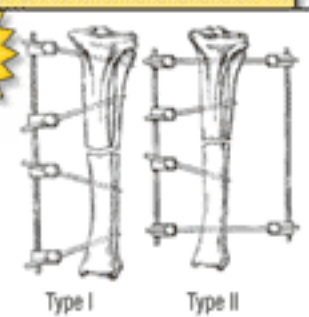

Jorvet Extra-Large or Equine KE

Oversized KE clamps takes a full 1/4" pin.

| | | |
|-----------|--------------------------|-------------|
| JOR371XLD | Double KE Clamp, X-Large | \$140.00/ea |
| JOR371XLS | Single KE Clamp, X-Large | \$77.00/ea |

Jorvet Connecting Rod

A variety of sizes are offered to work with every case.

| | | |
|-----------|--------------------|-----------|
| JOR371RMH | 3/16" x 10" length | \$9.00/ea |
|-----------|--------------------|-----------|



Jorvet Dynamic External Fixator Kit

New design allows KE device to do limb lengthening on a dynamic basis of 1mm per day. KE pins and threaded rods are the same sizes as standard KE parts. External Fixator Kit contains:

- 2 Threaded rods
- 4 Sliding double KE clamps
- 8 Locking nuts
- 2 Raised-center face pins
- 2 Trocar-trocar pins

| | | |
|-----------|--------|-------------|
| JOR371DFL | Large | \$640.00/ea |
| JOR371DFM | Medium | \$505.00/ea |
| JOR371DFS | Small | \$600.00/ea |



Jorvet Connecting Rods

| | | |
|------------|--------------------------|------------|
| JOR371RXLA | 100mm L., 5/16" diameter | \$32.00/ea |
| JOR371RXLB | 200mm L., 5/16" diameter | \$42.00/ea |
| JOR371RXLC | 300mm L., 5/16" diameter | \$52.50/ea |
| JOR371RXLD | 400mm L., 5/16" diameter | \$72.00/ea |



Jorvet KE Starter Kit with raised (positive) Threaded Pins

| | | |
|----------|--|-------------|
| JOR371XB | Medium Pin Kit. JOR371m 8 Medium Single Clamps. JOR371g 4 Positive Profile End-Threaded, medium. JOR371b 4 Positive Profile Mid-Threaded, medium. JOR371rmg 2 Connecting Bars, 8"L. JOR372d Drill Bit, 7/64". | \$279.00/ea |
|----------|--|-------------|

| | | |
|----------|--|-------------|
| JOR371XA | Small Pin Kit. JOR371s 8 Small Single Clamps. JOR371f 4 Positive Profile End-Threaded, small. JOR371a 4 Positive Profile Mid-Threaded, small. JOR371rsf 2 Connecting Bars, 6"L. JOR372b Drill Bit, 5/64". | \$304.00/ea |
|----------|--|-------------|

Jorvet Type-I Half Pin

Partially threaded pins engage the cortex and increase the pull out resistance.

| | | |
|----------|------------|-----------|
| JOR371PC | 5/32" x 5" | \$9.75/ea |
|----------|------------|-----------|



We do not stock all Orthopedic Products. Note that Jorvet/Jorgensen brand Products have a \$10 Dropship fee, as well as extra overnight fees.

13822 WEST BOULTON BLVD. METTAWA, IL 60045

WWW.SHOPMEDVET.COM

Phone 800-544-7521

237

Fax 800-204-2177



Jorvet Dynamic External Fixator Parts. Threaded Rods

| Part Number | Size | Price/ea |
|-------------|----------------|------------|
| JOR371TLA | Large, 100mm. | \$36.00/ea |
| JOR371TLB | Large, 200mm. | \$48.00/ea |
| JOR371TMA | Medium, 75mm. | \$36.00/ea |
| JOR371TMB | Medium, 150mm. | \$48.00/ea |
| JOR371TMC | Medium, 200mm. | \$45.00/ea |
| JOR371TSA | Small, 100mm. | \$21.00/ea |
| JOR371TSB | Small, 100mm | \$30.00/ea |

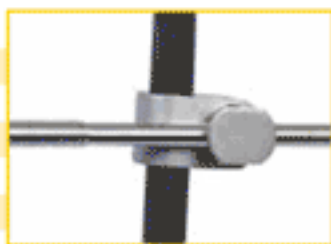

Jorvet External Fixation Clamps

All fixators are high grade surgical stainless steel and will interchange with other brands of fixators. New aesthetic design combined with a lower cost makes Jorvet external fixation equipment the best value.

| | | |
|----------|-------------------------------|------------|
| JOR371DL | Double Fixation Clamp. Large | \$47.00/ea |
| JOR371DM | Double Fixation Clamp. Medium | \$55.00/ea |
| JOR371L | Single Fixation Clamp. Large | \$33.00/ea |
| JOR371M | Single Fixation Clamp. Medium | \$25.50/ea |
| JOR371S | Single Fixation Clamp. Small | \$25.50/ea |

Jorvet External Fixation Rods

| Part Number | Size | Price/ea |
|-------------|----------------------------|-----------|
| JOR371RSA | Small Rod 1/8" D, 1 1/2" L | \$6.00/ea |
| JOR371RSB | Small Rod 1/8" D, 2" L | \$9.00/ea |
| JOR371RSD | Small Rod 1/8" D, 4" L | \$9.00/ea |
| JOR371RSF | Small Rod 1/8" D, 6" L | \$9.75/ea |

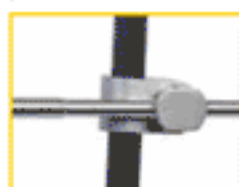

| Part Number | Size | Price/ea |
|-------------|----------------------------|-----------|
| JOR371RMA | Medium Rods, 3/16" D, 2" L | \$6.00/ea |
| JOR371RMC | Medium Rods, 3/16" D, 4" L | \$7.50/ea |
| JOR371RME | Medium Rods, 3/16" D, 6" L | \$8.40/ea |
| JOR371RMG | Medium Rods, 3/16" D, 8" L | \$9.00/ea |

| Part Number | Size | Price/ea |
|-------------|---------------------------|------------|
| JOR371RLA | Large Rods 5/16" D, 4" L | \$7.50/ea |
| JOR371RLB | Large Rods 5/16" D, 6" L | \$7.50/ea |
| JOR371RLC | Large Rods 5/16" D, 8" L | \$13.50/ea |
| JOR371RLD | Large Rods 5/16" D, 10" L | \$12.00/ea |
| JOR371RLE | Large Rods 5/16" D, 12" L | \$9.00/ea |

Jorvet Carbon Fiber ESF Bars

Carbon fiber ESF bars offer two advantages over conventional stainless. They are radiolucent and lighter in weight but comparable in strength. Note: carbon fiber needs to cut with a saw versus stainless pin cutters.

| | | |
|------------|------------------------------------|------------|
| JOR371RMAC | Medium Bars 3/16" D, 2" L | \$7.50/ea |
| JOR371RLAC | Large Bars 5/16" D, 5/16" W x 4" L | \$10.20/ea |
| JOR371RLBC | Large Bars 5/16" D, 5/15" W x 6" L | \$15.00/ea |



Jorvet Fixation Clamp

| | | |
|----------|---------------|------------|
| JOR371SH | Hinged, Small | \$93.00/ea |
| JOR371LH | Hinged, Large | \$96.00/ea |
| JOR371MH | Hinged Medium | \$94.00/ea |



Jorvet Dynamic External Fixator Parts Compatible with System

New design allows KE device to do limb lengthening on a dynamic basis of 1mm per day. KE pins and threaded rods are the same sizes as standard KE parts. External Fixator Kit contains:

- 2 Threaded rods
- 4 Sliding double KE clamps
- 8 Locking nuts
- 2 Raised-center face pins
- 2 Trocar-trocar pins



| | | |
|-----------|---------------------------------|-------------|
| JOR371DLC | Sliding Double KE Clamp. Large | \$108.00/ea |
| JOR371DMC | Sliding Double KE Clamp. Medium | \$96.00/ea |
| JOR371DMS | Sliding Single KE Clamp. Medium | \$46.50/ea |
| JOR371DSS | Sliding Single KE Clamp. Small | \$42.00/ea |
| JOR371KAL | KE Knurled Adjustor. Large. | \$28.50/ea |
| JOR371KAM | KE Knurled Adjustor. Medium. | \$25.50/ea |
| JOR371KAS | KE Knurled Adjustor. Small | \$25.50/ea |
| JOR371LL | KE Locking Nut. Large. | \$5.10/ea |
| JOR371LM | KE Locking Nut. Medium. | \$4.50/ea |
| JOR371LS | KE Locking Nut. Small. | \$4.50/ea |



Jorvet Medium Fixation Type I Kit

The pins of Type-I frame pass through both bone cortices. The clamps and connecting rods are assembled only on one side of the injured leg. Type-I Kit contains:

- 6 Single clamps
- 2 External fixation part thread pins
- 2 Double trocar smooth IM pins
- 1 Connecting rod



| | | |
|----------|-----------------------------------|-------------|
| JOR371KM | Medium. Pin, 1/8" dia. Rod, 8" L. | \$144.00/ea |
|----------|-----------------------------------|-------------|

Jorvet Mid-shaft Positive (Raised) Threaded External Fixation Pins

Positive or raised thread pins have threads extending above the smooth shaft on a portion of the pin. The positive threaded pins have a tougher pull-out resistance and are the external fixation pins used almost exclusively in human orthopedics. There are two choices of pin styles and three different sizes.

1. Threaded portion is in mid-shaft
2. Threaded portion is at the end of the pin

All pins are 316LVM implant quality stainless steel.

| | | |
|---------|---|------------|
| JOR371A | Small. Shaft 3/32" dia., Thread 1/8" dia., Thread Part 3/4" L, Total 4" L, Thread Pitch 0.9mm | \$18.00/ea |
| JOR371B | Medium. Shaft 1/8" dia., Thread 5/32" dia., Thread Part 11/4" L, Total 5" L, Thread Pitch 0.9mm | \$18.60/ea |
| JOR371C | Large. Shaft 5/32" dia., Thread 3/16" dia., Thread Part 11/2" L, Total 6" L, Thread Pitch 0.9mm | \$18.60/ea |



We do not stock all Orthopedic Products. Note that Jorvet/Jorgensen brand Products have a \$10 Dropship fee, as well as extra overnight fees.

13822 WEST BOULTON BLVD. METTAWA, IL 60045

WWW.SHOPMEDVET.COM

Phone 800-544-7521

238

Fax 800-204-2177



JORVET Small Linear Fixator Kit

Jorvet Small Linear Fixator Kit

- 4 each (total of 8) of 2.5mm (JOR1075d1) and 4mm (JOR1075d2) variant clamps
- 1 each size carbon rods lengths (4) J-1075ca, cb, cc, cd
- stainless steel container (JOR1075sc)
- J-1075wa, 7mm wrench
- 6 small linear fixator pins (JOR1075c series)

JOR1075 \$410.00/ea



Small Linear Fixator Pin

| | | |
|-----------|----------------------|-----------|
| JOR1075CM | 80mm x 4mm x 4mm | \$8.10/ea |
| JOR1075CN | 80mm x 4mm x 3mm | \$8.10/ea |
| JOR1075CP | 80mm x 2.5mm x 2.5mm | \$8.10/ea |
| JOR1075CR | 60mm x 2.5mm x 2.5mm | \$8.10/ea |
| JOR1075CS | 50mm x 2.5mm x 2.5mm | \$8.10/ea |
| JOR1075CT | 50mm x 2.5mm x 1.5mm | \$8.10/ea |

Small Linear Hook on Clamp

All parts available individually

| | | |
|-----------|-----------------------|------------|
| JOR1075D1 | uses 1.5mm-2.5mm pins | \$20.00/ea |
| JOR1075D2 | uses 3mm-4mm pins | \$20.00/ea |



Jorvet Small Linear Fixator

| | | |
|-----------|--------------------------------|------------|
| JOR1075CA | Carbon rod, 4mm x 75mm | \$8.00/ea |
| JOR1075CB | Carbon rod, 4mm x 100mm | \$10.00/ea |
| JOR1075CC | Carbon rod, 4mm x 150mm | \$12.00/ea |
| JOR1075CD | Carbon rod, 4mm x 200mm | \$14.00/ea |
| JOR1075CE | Carbon fibre bar 11mm x 150mm | \$28.00/ea |
| JOR1075CF | Carbon fibre bar, 11mm x 200mm | \$32.00/ea |
| JOR1075CG | Carbon fibre bar 11mm x 250mm | \$35.00/ea |
| JOR1075CJ | Carbon fibre bar, 11mm X 350mm | \$42.00/ea |

Wrench

| | | |
|-----------|-----------------|------------|
| JOR1075WB | 11mm | \$12.90/ea |
| JOR1075WC | 11mm Box Wrench | \$42.00/ea |
| JOR1075WA | 7 mm | \$12.90/ea |

Linear Fixation Container Jorvet

JOR1075SC \$290.00/ea

Large Linear Fixator System Jorvet

JOR1075LLK \$881.00/ea

Jorvet

Jorvet 2.7mm Cortical Self Tapping Screws

| | | | | | |
|-----------|----------------------|------------|-----------|----------------------|------------|
| JOR1072AT | 6mm 2.0mm, Titanium | \$27.50/ea | JOR1072GT | 16mm 2.0mm, Titanium | \$29.25/ea |
| JOR1072BT | 8mm 2.0mm, Titanium | \$27.50/ea | JOR1072HT | 20mm 2.0mm, Titanium | \$29.25/ea |
| JOR1072CT | 10mm 2.0mm, Titanium | \$27.75/ea | JOR1072IT | 22mm 2.0mm, Titanium | \$30.00/ea |
| JOR1072DT | 12mm 2.0mm, Titanium | \$27.75/ea | JOR1072JT | 24mm 2.0mm, Titanium | \$30.00/ea |
| JOR1072ET | 14mm 2.0mm, Titanium | \$28.50/ea | JOR1072KT | 26mm 2.0mm, Titanium | \$30.75/ea |
| JOR1072FT | 16mm 2.0mm, Titanium | \$28.50/ea | JOR1072LT | 28mm 2.0mm, Titanium | \$33.00/ea |

Jorvet 3.5mm Cortical Self Tapping Screws

| | | | | | |
|-----------|----------------------|------------|-----------|----------------------|------------|
| JOR1074AT | 16mm 2.5mm, Titanium | \$27.00/ea | JOR1074ET | 24mm 2.5mm, Titanium | \$29.25/ea |
| JOR1074BT | 18mm 2.5mm, Titanium | \$27.00/ea | JOR1074FT | 26mm 2.5mm, Titanium | \$29.25/ea |
| JOR1074CT | 20mm 2.5mm, Titanium | \$27.00/ea | JOR1074GT | 28mm 2.5mm, Titanium | \$30.00/ea |
| JOR1074DT | 22mm 2.5mm, Titanium | \$27.00/ea | JOR1074HT | 30mm 2.5mm, Titanium | \$30.00/ea |

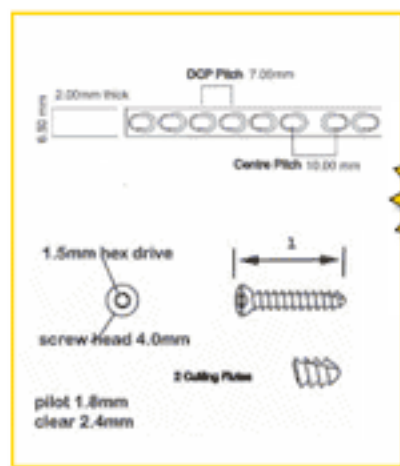

Cancellous Screw, Fully-Threaded, Self-Tapping, 4.0 mm



4mm Cancellous Screw, Full Thread. Use as cancellous screws where greater screw-bone interface is desirable. 6/pk.

| | | | | | |
|----------|--------|------------|----------|--------|------------|
| JOR424AS | 10mm L | \$9.00/ea | JOR424HS | 24mm L | \$10.50/ea |
| JOR424BS | 12mm L | \$9.00/ea | JOR424IS | 26mm L | \$15.00/ea |
| JOR424DS | 16mm L | \$9.00/ea | JOR424JS | 28mm L | \$15.00/ea |
| JOR424ES | 18mm L | \$10.50/ea | JOR424KS | 30mm L | \$15.00/ea |
| JOR424FS | 20mm L | \$10.50/ea | JOR424LS | 35mm L | \$15.00/ea |
| JOR424GS | 22mm L | \$10.50/ea | JOR424MS | 40mm L | \$15.00/ea |
| | | | JOR424NS | 45mm L | \$15.75/ea |

- BUY 1 GET 1 FREE SPECIALS!
- CLOSEOUTS @ DEEP DISCOUNTS!
- LOYAL CUSTOMERS SPECIALS!

Connect with us @:

facebook.com/medvetinternational

@SHOPMEDVET twitter



We do not stock all Orthopedic Products. Note that Jorvet/Jorgensen brand Products have a \$10 Dropship fee, as well as extra overnight fees.

13822 WEST BOULTON BLVD. METTAWA, IL 60045

WWW.SHOPMEDVET.COM

Phone 800-544-7521

239

Fax 800-204-2177



Jorvet Trocar-Trocar I. M. Pin

Highest quality type 316L stainless steel IM pins. Available in the points and diameters listed below. When ordering, please match diameter with point style number. Made in U.S.A.

| | | |
|---------|-------------|------------|
| JOR250I | 1/4" x 12" | \$12.60/ea |
| JOR250H | 3/16" x 12" | \$10.20/ea |



Jorvet IM Pin Starter Kit

IM pin starter kit comes with autoclavable pin bag. Please specify IM pin style desired. Kits include:

- 0.9mm — (.035") k-wire 6 ea.
- 1.1mm — (.045") k-wire 6 ea.
- 1.6mm — (.062") k-wire 6 ea.
- 1.6mm — 1/16" IM pin 2 ea.
- 2.0mm — 5/64" IM pin 2 ea.
- 2.3mm — 3/32" IM pin 2 ea.
- 2.6mm — 7/64" IM pin 2 ea.
- 3.0mm — 1/8" IM pin 2 ea.
- 3.4mm — 9/64" IM pin 2 ea.
- 3.8mm — 5/32" IM pin 2 ea.
- 4.5mm — 3/16" IM pin 2 ea.
- 6.0mm — 1/4" IM pin 2 ea.

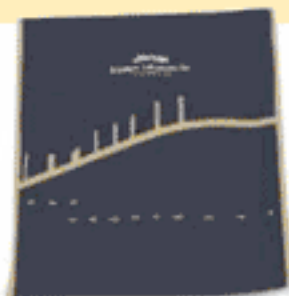

Trocar-Trocar **\$165⁰⁰/ea**
Trocar-Screw **\$200⁰⁰/ea**

| | | |
|---------|--|-------------|
| JOR250K | Trocar-Trocar Pin Starter Kit, kit with autoclavable pin bag | \$165.00/ea |
| JOR250L | Trocar-Screw Starter Kit, kit with autoclavable pin bag | \$200.00/ea |



Jorvet IM Pin Deluxe Kit

IM pin Deluxe Kit comes with autoclavable pin bag.

- 0.9mm — (.035") k-wire 6 ea.
- 1.1mm — (.045") k-wire 6 ea.
- 1.6mm — (.062") k-wire 6 ea.
- 1.6mm — 1/16" IM pin 4 ea.
- 2.0mm — 5/64" IM pin 4 ea.
- 2.3mm — 3/32" IM pin 6 ea.
- 2.6mm — 7/64" IM pin 6 ea.
- 3.0mm — 1/8" IM pin 6 ea.
- 3.4mm — 9/64" IM pin 6 ea.
- 3.8mm — 5/32" IM pin 6 ea.
- 4.5mm — 3/16" IM pin 4 ea.
- 6.0mm — 1/4" IM pin 4 ea.

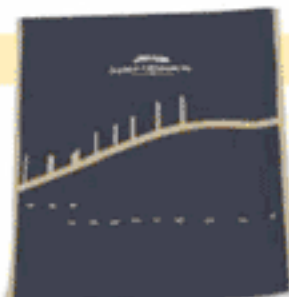

Trocar-Trocar **\$291⁰⁰/ea**
Trocar-Screw **\$330⁰⁰/ea**

| | | |
|----------|-------------------------------|-------------|
| JOR250LD | Trocar-Screw Pin Deluxe Kit. | \$330.00/ea |
| JOR250KD | Trocar-Trocar Pin Deluxe Kit. | \$291.00/ea |



Jorvet Im Pin Bag

IM pin bag that allows IM pin organization in a neat and easy-to-find fashion.

| | | |
|--------|--------------|-----------------------------|
| JOR250 | Autoclavable | \$19⁸⁰/bg |
|--------|--------------|-----------------------------|

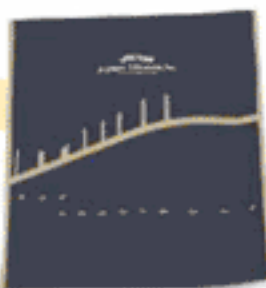

Jorvet Steinman Pin

Highest quality type 316L stainless steel IM pins. Available in the points and diameters listed below. When ordering, please match diameter with point style number. Made in U.S.A.

| | | |
|---------|-----------------------------|------------|
| JOR251A | 1/16" X 7" w/trocar-screw | \$5.25/ea |
| JOR251B | 5/64" X 7", w/trocar-screw | \$5.55/ea |
| JOR251C | 3/32 X 8, w/trocar-screw | \$7.20/ea |
| JOR251D | 7/64 X 8, w/trocar-screw | \$7.20/ea |
| JOR251E | 1/8" x 9", w/trocar-screw | \$6.45/ea |
| JOR251G | 5/32" x 10", w/trocar-screw | \$8.25/ea |
| JOR251H | 3/16" x 12", w/trocar-screw | \$10.65/ea |
| JOR251I | 1/4" x 12", w/trocar-screw | \$11.10/ea |



Round Trocar

Stainless steel with 10 plastic disposable cannulae. 5. shaft.

| | | |
|--------|-----------|------------|
| JOR40P | 5. shaft. | \$94.00/ea |
|--------|-----------|------------|



Equine Trocar/Cannula

Suggested use for cecum puncture.

| | | |
|---------|--|-------------|
| JOR40EK | Very small 3mm dia. x 135mm (5.4") shaft | \$148.00/ea |
|---------|--|-------------|



Corkscrew Trocar with Plastic Stylet

This is the self-retaining bloot trocar used in chronic bloats. Make a small 3/4" incision in hide. Screw the trocar into position. After insertion, the rumen should be pulled up close to the peritoneum by placing a few wraps of gauze between the trocar plate and hide.

| | |
|--------|-----------|
| JOR40F | \$4.80/ea |
|--------|-----------|



Jorvet Pin Cutter

- For cutting intramedullary pins and customizing bone plates
- Stainless steel. 1470g. 48cm(19"L).
- Cuts up to 6.4mm (1/4") pins.
- Narrow jaws allow extra-close pin cutting

| | | |
|--------|------------------------|-------------|
| JOR220 | 19" L, Stainless Steel | \$295.00/ea |
|--------|------------------------|-------------|



IM Bone Pin Protective Tube

Stores Bone Pins in an aluminum autoclavable round tube with a screw-on cap.

| | | |
|---------|--|-------------|
| JOR250X | 320mm long x 30mm diameter | \$104.00/ea |
| JOR250Y | 225mm long x 30mm diameter for "K" wires | \$104.00/ea |



We do not stock all Orthopedic Products. Note that Jorvet/Jorgensen brand Products have a \$10 Dropship fee, as well as extra overnight fees.

Fessa Tubular Fixation System & Cortical Nut

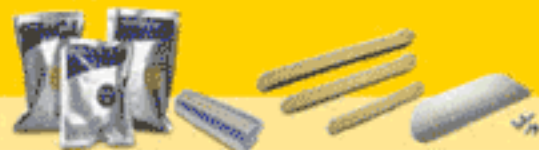

Fessa Tubular Fixator System

This system is widely used in Europe and offers several advantages over conventional fixator systems. The connecting tubes or rods use a simple hexhead set screw as the pin holding or clamping mechanism. The system is very strong for its light weight. The smaller tubes will accept the smallest of K-wire making it extremely useful in fracture management of small exotics and cats.

| | | |
|----------|------------------------------|-------------|
| JOR1050 | 6/7mm Starter Kit | \$520.00/ea |
| JOR1050A | 6mm X 30mm long tube | \$42.00/ea |
| JOR1050B | 6mm X 45mm long tube | \$45.00/ea |
| JOR1051B | 8mm X 150mm tube | \$87.00/ea |
| JOR1051C | 8mm X 200mm l tube | \$87.00/ea |
| JOR1051E | Locking Screws (10) - 8mm | \$21.00/ea |
| JOR1050C | 6mm X 65mm long tube | \$60.00/ea |
| JOR1050D | Hexdriver Allen wrench - 6mm | \$21.00/ea |
| JOR1050E | Locking Screws (10) - 6mm | \$19.50/ea |
| JOR1050F | 6mm hinge | \$60.00/ea |
| JOR1051A | 8mm X 100mm tube | \$66.00/ea |
| JOR1051D | Hexdriver Allen wrench - 8mm | \$15.00/ea |
| JOR1051F | 8mm hinge | \$81.00/ea |

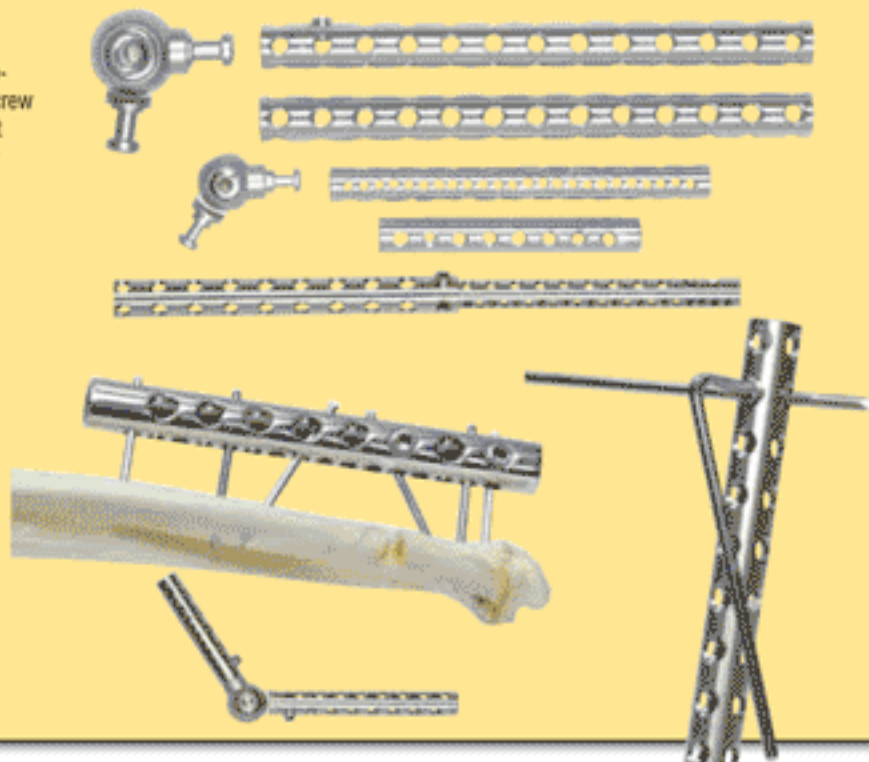

Jorvet Combination Drill Tap & Insert

| | | |
|----------|------------------|-------------|
| JOR1072G | for 2.7mm screws | \$132.00/ea |
| JOR1072H | for 3.5mm screw | \$132.00/ea |



Jorvet 2.0mm Drill Bit Hard

| | |
|----------|------------|
| JOR372BH | \$39.00/ea |
|----------|------------|



Jorvet Cortical Nut

Occasionally tapped threads strip and a larger screw is inappropriate. Lag screws are particularly vulnerable, as only one cortex is available for tapping. A cortical nut manufactured from implant grade nylon can give the screw purchase to allow normal tightening. The thread form is designed to grip the screw to minimize backing out. Sterile.

| | | |
|---------|-------|------------|
| JOR375A | 2.7mm | \$15.00/ea |
| JOR375B | 3.5mm | \$19.50/ea |
| JOR375C | 4.5mm | \$21.00/ea |



Jorvet Pin Removal Forceps

Pin removal is made easy with this forceps. Also useful for bending, holding, and cutting small pins and wires. Parallel action pliers may be used in tandem with bone plate bender for contouring smaller plates.

| | | |
|--------|--------------------------------|-------------|
| JOR442 | Stainless Steel, w/Wire Cutter | \$246.00/ea |
|--------|--------------------------------|-------------|



Jorvet Enclosed Bone Pin Cutter

Completely covers a bone pin up to 4mm (5/32"). Addresses the problems created by open end standard pin cutters. The enclosed shearing action of the pin cutter:

- Eliminates the potentially dangerous flying pin end.
- Removes sharp point that can irritate soft tissue or cut the patient or people coming into contact.
- Eliminates the slightly deformed pin end that could jam the KE clamps.

| | | |
|---------|-------------------|-------------|
| JOR220P | up to 4mm (5/32") | \$224.00/ea |
|---------|-------------------|-------------|



Pincutter with Breakdown Handle

Large pin cutter similar to JOR220 only handles detach to fit into smaller autoclaves. From 490mm (19 3/8") to 260mm (10 3/8"). Gold colored handles with tungsten carbide inserts.

| | |
|---------|-------------|
| JOR220Q | \$340.00/ea |
|---------|-------------|



We do not stock all Orthopedic Products. Note that Jorvet/Jorgensen brand Products have a \$10 Dropship fee, as well as extra overnight fees.

13822 WEST BOULTON BLVD. METTAWA, IL 60045

WWW.SHOPMEDVET.COM

Phone 800-544-7521

241

Fax 800-204-2177



Cortical Self Tapping Screws & Compression Plates

Cortical Self-Tapping Screw 2.7mm



| | | | | | |
|----------|--------|------------|----------|--------|------------|
| JOR419AS | 6mm L | \$9.00/ea | JOR419IS | 22mm L | \$12.00/ea |
| JOR419BS | 8mm L | \$9.00/ea | JOR419JS | 24mm L | \$12.00/ea |
| JOR419CS | 10mm L | \$10.50/ea | JOR419KS | 26mm L | \$12.00/ea |
| JOR419DS | 12mm L | \$10.50/ea | JOR419LS | 28mm L | \$12.00/ea |
| JOR419ES | 14mm L | \$10.50/ea | JOR419MS | 30mm L | \$12.00/ea |
| JOR419FS | 16mm L | \$10.50/ea | JOR419NS | 32mm L | \$12.00/ea |
| JOR419GS | 18mm L | \$10.50/ea | JOR419OS | 34mm L | \$12.00/ea |
| JOR419HS | 20mm L | \$10.50/ea | JOR419PS | 36mm L | \$13.50/ea |
| JOR419HS | 20mm L | \$15.00/ea | JOR419RS | 40mm L | \$13.50/ea |

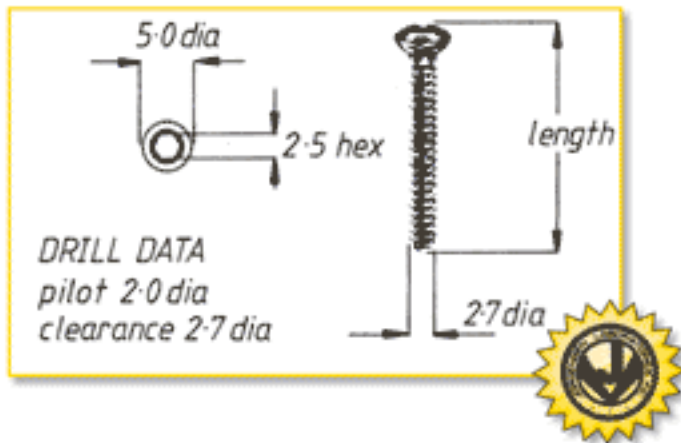

Cortical Self-Tapping Screw 3.5mm



| | | | | | |
|----------|--------------|------------|----------|--------------|------------|
| JOR421AS | 10mm L | \$10.50/ea | JOR421IS | 3.5mm x 26mm | \$10.50/ea |
| JOR421BS | 12mm L | \$10.50/ea | JOR421JS | 3.5mm x 28mm | \$10.50/ea |
| JOR421CS | 14mm L | \$10.50/ea | JOR421KS | 3.5mm x 30mm | \$10.50/ea |
| JOR421DS | 3.5mm x 16mm | \$10.50/ea | JOR421LS | 3.5mm x 32mm | \$11.25/ea |
| JOR421ES | 3.5mm x 18mm | \$10.50/ea | JOR421MS | 3.5mm x 34mm | \$11.25/ea |
| JOR421FS | 3.5mm x 20mm | \$10.50/ea | JOR421NS | 3.5mm x 36mm | \$18.00/ea |
| JOR421GS | 3.5mm x 22mm | \$13.50/ea | JOR421OS | 3.5mm x 40mm | \$15.00/ea |
| JOR421HS | 3.5mm x 24mm | \$14.10/ea | JOR421TS | 3.5mm x 38mm | \$11.25/ea |

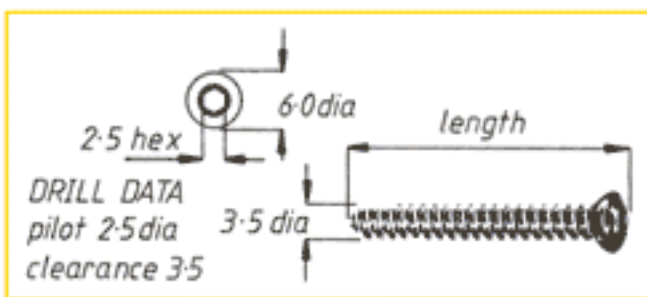

Cortical Self-Tapping Screw 4.5mm

| | | |
|----------|--------|------------|
| JOR426AS | 14mm L | \$13.50/ea |
| JOR426DS | 26mm L | \$13.50/ea |
| JOR426ES | 30mm L | \$13.50/ea |
| JOR426FS | 28mm L | \$13.80/ea |



Jorvet Compression Plates 2.0mm

2mm Compression Plate. Use with 2mm cortical screws if compression is required.

| | | |
|---------|---------------|------------|
| JOR417A | 4 holes, 22mm | \$57.00/ea |
| JOR417B | 5 holes, 27mm | \$57.00/ea |
| JOR417C | 6 holes, 32mm | \$57.00/ea |
| JOR417D | 7 holes, 37mm | \$66.00/ea |
| JOR417E | 8 holes, 42mm | \$66.00/ea |



Disposable Plastic Cannulae

Holes in cannulae allow suture attachment.

| | | |
|---------|-------|---------|
| JOR40PC | 10/pk | \$64.00 |
|---------|-------|---------|



Pearson Raised Thread Pins

Smooth-shank pins have poor resistance to pull out. Negative-thread pins are weak. Positive or raised thread pins offer strength and good pull-out resistance. The Pearson pin addresses three major problems associated with the use of threaded pins:

1. Threads are proud of the shank, eliminating the point of weakness found at the thread-shank interface of negative-thread pins.
2. Existing self-tapping pins impact bone debris at the bone pin interface, causing necrosis and microfractures. The Pearson pin has a unique flute form that collects bone debris as it is formed, minimizing damage to the bonepin interface.
3. Trocar tipped pins cause thermal necrosis if inserted without pre-drilling. Pre-drilling takes time and causes soft tissue damage. The Pearson pin incorporates a unique drill point designed for minimal "skate" on the bone surface. The pin pre-drills its own pilot hole. The Pearson pin is available in 1/8", 5/32", and 1/4" shanks, with either end-thread or mid-thread.

| | | |
|----------|----------------------------------|------------|
| JOR371HP | End-Thread Pin. 5/32" shank, 6"L | \$31.00/ea |
| JOR371BP | Mid-Thread Pin. 1/8" shank, 5"L | \$39.00/ea |



We do not stock all Orthopedic Products. Note that Jorvet/Jorgensen brand Products have a \$10 Dropship fee, as well as extra overnight fees.

Orthopedic Products

Bone Drill Bits & Self Tapping System



Jorvet Bone Drill Bit



For pre-drilling positive profile pins. Pre-drill with a bit slightly smaller than the pin shank.

| | | |
|---------|--|------------|
| JOR372J | 1.9mm for 2.0mm (5/64") Positive KE X-small pins | \$27.00/ea |
| JOR372K | 2.3mm for 2.4mm (3/32") Positive KE small pins | \$26.00/ea |
| JOR372L | 3.0mm for 3.2mm (1/8") Positive KE medium pins | \$27.00/ea |
| JOR372N | 3.8mm for 4.0mm (5/32") Positive KE large pins | \$32.00/ea |

Jorvet Anti-Skid Drill Bits

These drill bits have a sharp needle point tip that penetrates the bone for easier drilling. It helps avoid skipping over the bone especially if drilling at an angle other than 90°. Made from hard 420 stainless steel.

| | | |
|----------|------------------------------------|------------|
| JOR372FX | Bit. 9/64", 3.5mm., Length 13cmv | \$40.00/ea |
| JOR372AX | Bit. 1/16", 1.5mm., Length 6cmv | \$45.00/ea |
| JOR372BX | Bit. 5/64", 2.0mm., Length 10cmv | \$41.50/ea |
| JOR372CX | Bit. 3/32", 2.5mm., Length 11.5cmv | \$41.50/ea |
| JOR372DX | Bit. 7/64", 2.7mm., Length 13cm.v | \$40.00/ea |
| JOR372EX | Bit. 1/8", 3.2mm., Length 13cmv | \$40.00/ea |
| JOR372GX | Bit. 5/32", 4.5mm., Length 13cmv | \$40.00/ea |

For pre-drilling positive profile pins. Pre-drill with a bit slightly smaller than the pin shank.

| | | |
|----------|--|------------|
| JOR372CZ | <ul style="list-style-type: none"> • 2.5mm drill bit. • Standard razor tip • Gold titanium nitride coating finish • Will out-last and out-perform any standard drill bit | \$36.50/ea |
|----------|--|------------|



Orthopedic Drill Case w/9 Drill Bits

Drill Case with 9 different standard drill bits (JOR372A-I).

JOR372XC \$330.00/ea



Stainless Steel Orthopedic Drill Case

This folding box can hold 10 standard size drill bits. Autoclavable. Measures 5 1/2" x 4" x 3/4". Stainless steel. (Bits not included.)

JOR372X \$199.00/ea



Sherman Self-Tapping Plate System

JOR430 3.5mm and 2.7mm \$1,700.00/ea

Includes:

- (1)JOR372c Drill Bit. 3/32", 2.4mm
- (1)JOR372d Drill Bit. 7/64", 2.7mm
- (1)JOR372f Drill Bit. 9/64", 3.5mm
- (1)JOR414 Small Drill Guide. 3.5mm I.d.
- (1)JOR414b Insert Sleeve 3.5/2.7mm
- (1)JOR401c Screwdriver only for 2.7mm Flat head
- (1)JOR401e Screwdriver only for 3.5mm Cruciate head
- (1)JOR853a Bone Plate Benders
- (1)JOR410 Depth Gauge
- (1)Self-Tapping Plating Case with 2.7/3.5mm screw rack



Plates

| | |
|------------|--|
| (1)JOR408a | 8 holes x 104mm |
| (1)JOR408b | 9 holes x 117mm |
| (1)JOR408c | 10 holes x 130mm |
| (1)JOR405c | 2.7mm Round Hole Plate. 4 holes x 27mm |
| (1)JOR405e | 2.7mm Round Hole Plate. 5 holes x 33mm |
| (1)J-405g | 2.7mm Round Hole Plate. 6 holes x 39mm |
| (1)J-407d | 3.5mm Round Hole Plate. 5 holes x 58mm |
| (1)JOR407f | 3.5mm Round Hole Plate. 6 holes x 76mm |
| (1)JOR407g | 3.5mm Round Hole Plate. 7 holes x 82mm |

Screws

| | |
|------------|--|
| (1)JOR404a | 2.7mm Self-Tapping Screw. 6/pk. 10mm L |
| (1)JOR404b | 2.7mm Self-Tapping Screw. 6/pk. 13mm L |
| (1)JOR404c | 2.7mm Self-Tapping Screw. 6/pk. 16mm L |
| (1)JOR404d | 2.7mm Self-Tapping Screw. 6/pk. 19mm L |
| (1)JOR404e | 2.7mm Self-Tapping Screw. 6/pk. 22mm L |
| (1)JOR406c | 3.5mm Self-Tapping Screw. 6/pk. 16mm L |
| (1)JOR406d | 3.5mm Self-Tapping Screw. 6/pk. 19mm L |
| (1)JOR406e | 3.5mm Self-Tapping Screw. 6/pk. 22mm L |
| (1)JOR406f | 3.5mm Self-Tapping Screw. 6/pk. 25mm L |
| (1)JOR406g | 3.5mm Self-Tapping Screw. 6/pk. 28mm L |
| (1)JOR406h | 3.5mm Self-Tapping Screw. 6/pk. 31mm L |
| (1)JOR406i | 3.5mm Self-Tapping Screw. 6/pk. 34mm L |
| (1)JOR406j | 3.5mm Self-Tapping Screw. 6/pk. 38mm L |
| (1)JOR406k | 3.5mm Self-Tapping Screw. 6/pk. 41mm L |
| (1)JOR406l | 3.5mm Self-Tapping Screw. 6/pk. 44mm L |

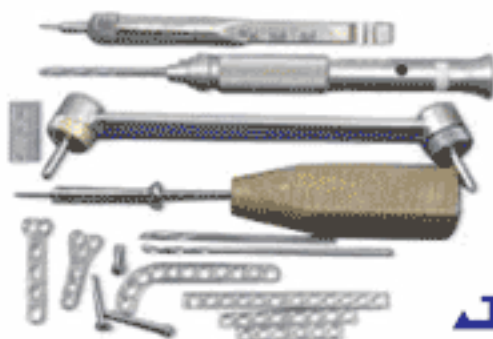

We do not stock all Orthopedic Products. Note that Jorvet/Jorgensen brand Products have a \$10 Dropship fee, as well as extra overnight fees.

13822 WEST BOULTON BLVD. METTAWA, IL 60045

WWW.SHOPMEDVET.COM

Phone 800-544-7521

243

Fax 800-204-2177

Orthopedic Products

Screw Driver with Sleeve, Bone Plate & Self Tapping Screws



Jorvet Screwdriver with Sleeve

| | | |
|---------|---------------------------------|-------------|
| JOR401E | For 3.5mm screw. Cruciate head | \$114.00/ea |
| JOR401A | Only for 2.0mm screw. Flat head | \$105.00/ea |
| JOR401C | Only for 2.7mm screw. Flat head | \$105.00/ea |
| JOR401B | Only for 2.0mm screw. | \$93.00/ea |
| JOR401D | For 2.7mm screw | \$87.00/ea |



Jorvet Self-Tapping Screw, 2.7mm (7/64")

For use with 2.7mm (7/64") round-hole plates in small- to medium-sized patients. 6/pk.

| | | | | | |
|---------|--------|------------|---------|--------|------------|
| JOR404A | 10mm L | \$31.50/pk | JOR404H | 31mm L | \$31.50/pk |
| JOR404B | 13mm L | \$31.50/pk | JOR404I | 34mm L | \$31.50/pk |
| JOR404C | 16mm L | \$31.50/pk | JOR404J | 38mm L | \$31.50/pk |
| JOR404D | 19mm L | \$31.50/pk | JOR404K | 41mm L | \$33.00/pk |
| JOR404E | 22mm L | \$31.50/pk | JOR404L | 44mm L | \$33.00/pk |
| JOR404F | 25mm L | \$31.50/pk | JOR404M | 48mm L | \$33.00/pk |
| JOR404G | 28mm L | \$31.50/pk | JOR404N | 50mm L | \$33.00/pk |
| | | | JOR404O | 57mm L | \$36.00/pk |

Jorvet 2mm Self-Tapping Screw

| | | | | | |
|---------|-----------------|------------|---------|-----------------|------------|
| JOR402A | 2mm x 6mm, 6pk | \$30.00/pk | JOR402E | 2mm x 14mm, 6pk | \$31.50/pk |
| JOR402B | 2mm x 8mm, 6pk | \$30.00/pk | JOR402F | 2mm x 16mm, 6pk | \$31.50/pk |
| JOR402C | 2mm x 10mm, 6pk | \$30.00/pk | JOR402G | 2mm x 18mm, 6pk | \$33.00/pk |
| JOR402D | 2mm x 12mm, 6pk | \$30.00/pk | JOR402H | 2mm x 20mm, 6pk | \$33.00/pk |

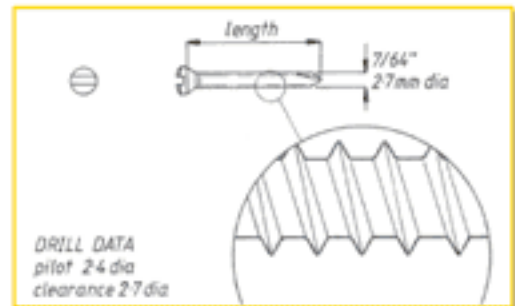
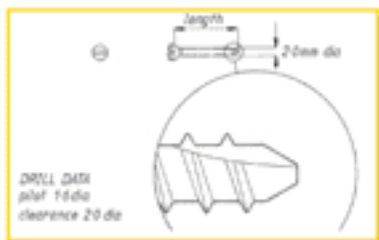

Jorvet 2.0mm Bone Plate (Round Holes)

| | | | | | |
|---------|---------------|------------|---------|---------------|------------|
| JOR403A | 2-hole 13mm | \$18.00/ea | JOR403F | 6 holes, 30mm | \$37.00/ea |
| JOR403B | 4-hole 20mm L | \$25.50/ea | JOR403G | 6 holes, 33mm | \$37.00/ea |
| JOR403C | 4 holes, 23mm | \$25.50/ea | JOR403H | 7 holes, 35mm | \$41.00/ea |
| JOR403D | 5 holes, 25mm | \$30.00/ea | JOR403I | 7 holes, 38mm | \$42.00/ea |
| JOR403E | 5 holes, 28mm | \$30.00/ea | JOR403J | 8 holes, 40mm | \$44.00/ea |
| | | | JOR403K | 8 holes, 43mm | \$47.00/ea |

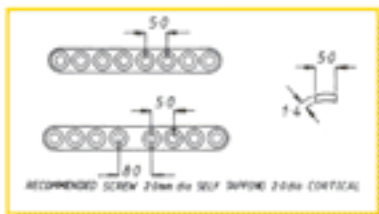

Jorvet Round Hole Plate 2.7mm

6mm W x 2mm thick bone plates for 2.7mm (7/64") screws. The 2.7mm round-hole plate has holes at 6mm intervals, and comes in a range of lengths.

| | | | | | |
|---------|----------------------|------------|---------|----------------------|------------|
| JOR405A | 2.7mm, 2 holes, 15mm | \$18.00/ea | JOR405G | 2.7mm, 6 holes, 39mm | \$34.50/ea |
| JOR405B | 2.7mm, 4 holes, 24mm | \$24.00/ea | JOR405H | 2.7mm, 7 holes, 42mm | \$36.00/ea |
| JOR405C | 2.7mm, 4 holes, 27mm | \$24.00/ea | JOR405I | 2.7mm, 7 holes, 45mm | \$36.00/ea |
| JOR405D | 2.7mm, 5 holes, 30mm | \$28.50/ea | JOR405J | 2.7mm, 8 holes, 48mm | \$42.00/ea |
| JOR405E | 2.7mm, 5 holes, 33mm | \$28.50/ea | JOR405K | 2.7mm, 8 holes, 51mm | \$42.00/ea |
| JOR405F | 2.7mm, 6 holes, 36mm | \$34.50/ea | | | |

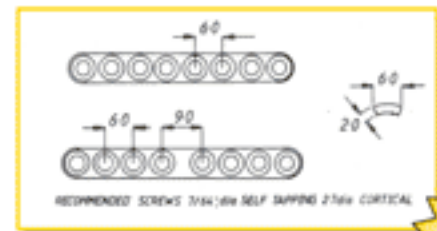

2mm Sherman Self-Tapping Screw Kit

- 2mm Sherman Self-Tapping Screw Kit.
- (1) JOR401a Screwdriver for 2.0mm self-tapping screws.
 - (1) JOR372a Pilot Drill Bit. 1.6mm.
 - (1) JOR372b Drill Bit. 2.0mm.
 - (1) JOR415a Sleeve for 2.0mm bit. For soft tissue protection.
 - (1) JOR430cs Stainless Steel Case with screw rack.
 - (1) JOR410a Depth Gauge Bone Screws: packages of 6 2.0mm Bone Plate. Round holes.
 - (6) JOR402a 6mm
 - (6) JOR402b 8mm
 - (6) JOR402c 10mm
 - (6) JOR403c Bone Plate. 4-hole 23mm L.
 - (6) JOR402b 8mm
 - (6) JOR403e Bone Plate. 5-hole 28mm L.
 - (6) JOR403g Bone Plate. 6-hole 33mm L.



JOR430S \$780.00/ea

Reconstruction Bone Plate (cuttable and malleable)

| | | |
|---------|--------------------------------------|-------------|
| JOR374A | 24-hole. Uses 2.7mm screws. 150mm L. | \$152.00/ea |
| JOR374B | 30-hole. Uses 2.0mm screws. 150mm L. | \$160.00/ea |



We do not stock a. . . products have a \$10 Dropship fee, as well as extra overnight fees.

13822 WEST BOULTON BLVD. METTAWA, IL 60045

WWW.SHOPMEDVET.COM

Phone 800-544-7521

244

Fax 800-204-2177

Orthopedic Products

Sherman Self Taping Screws & Basic Plating Kit



Sherman Self Tap Screws, 3.5mm (9/64")

The 9/64" self-tapping screw has similar pull-out resistance to 3.5mm cortical screws. The main problem with this screw has been a lack of suitable bone plates. Our new range of 3.5mm round-hole plates considerably widens the scope of these self-tapping screws. Cruciate head. 6/pk.

| | | |
|---------|-----------------------------|------------|
| JOR406A | 3.5mm x10mm, 6pk, cruciate | \$33.00/pk |
| JOR406B | 3.5mm x 13mm, 6pk, cruciate | \$33.00/pk |
| JOR406C | 3.5mm x 16mm, 6pk, cruciate | \$33.00/pk |
| JOR406D | 3.5mm x19mm, 6pk, cruciate | \$33.00/pk |
| JOR406E | 3.5mm x 22mm, 6pk, cruciate | \$33.00/pk |
| JOR406F | 3.5mm x 25mm, 6pk, cruciate | \$33.00/pk |
| JOR406G | 3.5mm x 28mm, 6pk, cruciate | \$33.00/pk |
| JOR406H | 3.5mm x 31mm, 6pk, cruciate | \$33.00/pk |
| JOR406I | 3.5mm x 34mm, 6pk, cruciate | \$42.00/pk |
| JOR406J | 3.5mm x 38mm, 6pk, cruciate | \$42.00/pk |
| JOR406K | 3.5mm x 41mm, 6pk, cruciate | \$42.00/pk |
| JOR406L | 3.5mm x 44mm, 6pk, cruciate | \$42.00/pk |
| JOR406M | 3.5mm x 48mm, 6pk, cruciate | \$42.00/pk |
| JOR406N | 3.5mm x 50mm, 6pk, cruciate | \$42.00/pk |
| JOR406O | 3.5mm x 57mm, 6pk,cruciate | \$42.00/pk |

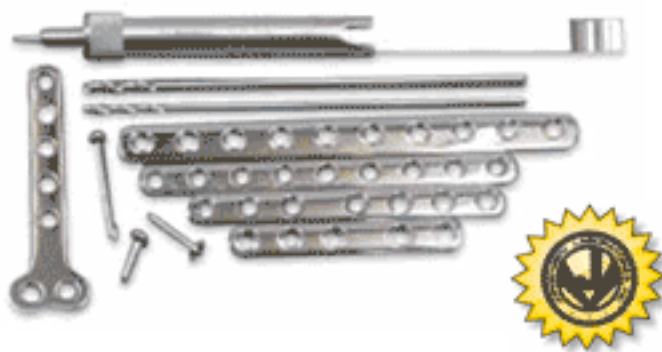

Round-Hole Plate 3.5mm Heavy-Duty

12mm W, 4mm thick heavy-duty plate is stronger than either the 3.5mm compression plate or our 3.5mm standard round-hole plate. Use of this plate makes 3.5mm cortical or 9/64" screws appropriate for the larger canine breeds.

| | | | | | |
|---------|----------------|------------|---------|----------------|------------|
| JOR408A | 8 holes 104mm | \$47.00/ea | JOR408E | 12 holes 156mm | \$64.00/ea |
| JOR408B | 10 holes 130mm | \$54.00/ea | JOR408F | 13 holes 169mm | \$69.00/ea |
| JOR408C | 10 holes 130mm | \$54.75/ea | JOR408G | 14 holes 180mm | \$75.00/ea |
| JOR408D | 11 holes 143mm | \$54.00/ea | JOR408H | 15 holes 195mm | \$82.00/ea |

RECOMMENDED SCREWS 9/64"dia SELF TAPPING 35mm dia CORTICAL
35mm dia CANCELLOUS 4.0 CANCELLOUS

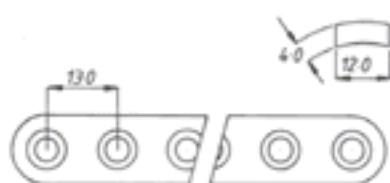

Round Hole Plate 3.5mm

A stronger and less expensive alternative to 3.5mm compression plates. Material is compatible with your choice of cortical or self-tapping screws.

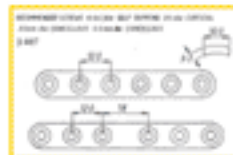

| | | | | | |
|---------|---------------|------------|---------|-----------------|------------|
| JOR407A | 2 holes, 22mm | \$19.50/ea | JOR407I | 8 holes, 94mm | \$47.00/ea |
| JOR407B | 4 holes, 46mm | \$25.50/ea | JOR407J | 8 holes, 100mm | \$47.00/ea |
| JOR407C | 4 holes, 52mm | \$25.50/ea | JOR407K | 9 holes, 106mm | \$49.00/ea |
| JOR407D | 5 holes, 58mm | \$33.00/ea | JOR407L | 9 holes, 118mm | \$49.00/ea |
| JOR407E | 6 holes, 70mm | \$39.00/ea | JOR407M | 10 holes, 118mm | \$54.00/ea |
| JOR407F | 6 holes, 76mm | \$36.00/ea | JOR407N | 10 holes, 130mm | \$55.00/ea |
| JOR407G | 7 holes, 82mm | \$42.50/ea | | | |
| JOR407H | 7 holes, 88mm | \$42.50/ea | | | |

Compression Plating Case

Stainless Steel Case. 2.7/3.5mm screw rack
JOR429D w 2.7/3.5mm Screw Rack \$340.00/ea



Bone Screw Rack

JOR429D2M Rack for JOR429D \$130.00/ea

Compression Bone Plating Basic Kit

The object of compression is to provide primary bone healing. A special guide is used to position the pilot drill hole. The corresponding tap then cuts the thread path. As the cortical screws are tightened through the unique plate holes, they are forced away from the side of the hole toward the fracture site. Compression of both fragments is then achieved. Set includes instrumentation and an assortment of implants for plating and lag screw procedures.

- (1)JOR372cz Drill Bit. 2.5mm
- (1)JOR372f Drill Bit. 3.5mm
- (1)JOR414 Drill Guide with point. 3.5mm i.d.
- (1)JOR414bb Insert Sleeve. 3.5mm o.d., 2.5mm i.d.
- (1)JOR409f Cortical Tap. 3.5mm
- (1)JOR409d Cancellous Tap. 4.0mm
- J-410 Depth Gauge (2.7-4.0mm)
- JOR411c Load/Neutral Drill Guide. 3.5mm plates
- Hex Head Screwdriver for 2.7/3.5/4.0 screw with sleeve
- Tap Handle
- Small Countersink with T-handle (2.7-4.0mm)
- Tap Sleeve
- Plate Benders
- 3.5mm Cortical Screws (6pk)
- (6)JOR421d 16mm
- (6)JOR421e 18mm
- (6)JOR421f 20mm
- (6)JOR421g 22mm
- (6)JOR421h 24mm
- (6)JOR421i 26mm
- (6)JOR421k 30mm
- 4.0 Cancellous Screws (6pk)
- (6)JOR424h 4mm 24mm L
- (6)JOR424j 4mm 28mm L
- (6)JOR424e 4mm 18mm L
- 3.5mm Compression Plates
- (1)JOR422d 5 holes x 62mm
- (1)JOR422e 6 holes x 74mm
- (1)JOR422f 7 holes x 86mm(1)JOR422g 8 holes x 96mm
- (1)JOR429d Stainless Steel Case. 2.7/3.5mm screw rack



JOR429 \$2,150.00/ea

We do not stock all Orthopedic Products. Note that Jorvet/Jorgensen brand Products have a \$10 Dropship fee, as well as extra overnight fees.

13822 WEST BOULTON BLVD. METTAWA, IL 60045

WWW.SHOPMEDVET.COM

Phone 800-544-7521

245

Fax 800-204-2177

Cortical Self Tapping Screws



2.7mm Cortical Screw and Equipment

- JOR412b Hex Screwdriver for 2.7-4.0mm screws with sleeve.
- JOR409b 2.7mm Tap.
- JOR372b 2.0mm Pilot Drill Bit. Round shaft.
- JOR372d 2.7mm Clearance Drill Bit. Round shaft.
- JOR410 Depth Gauge. 2.7-4mm.
- JOR413 Tap Handle for 2.7-4.5mm screws.



All 2.7 Cortical Screw Equipment Sold Individually Only

2.4mm Cortical Self Tapping Screws

Titanium

| | | |
|-----------|-------------------------------|------------|
| JOR1072AT | 6mm 2.0mm, Titanium | \$27.50/ea |
| JOR1072BT | Titanium, 8mm 2.0mm, Titanium | \$27.50/ea |
| JOR1072CT | 10mm 2.0mm, Titanium | \$27.75/ea |
| JOR1072DT | 12mm 2.0mm, Titanium | \$27.75/ea |
| JOR1072ET | 14mm 2.0mm, Titanium | \$28.50/ea |
| JOR1072FT | 16mm 2.0mm, Titanium | \$28.50/ea |
| JOR1072GT | 18mm 2.0mm, Titanium | \$29.25/ea |
| JOR1072HT | 20mm 2.0mm, Titanium | \$29.25/ea |
| JOR1072IT | 22mm 2.0mm Titanium | \$30.00/ea |
| JOR1072JT | 24mm 2.0mm, Titanium | \$30.00/ea |
| JOR1072KT | 26mm 2.0mm, Titanium | \$30.75/ea |
| JOR1072LT | 28mm 2.0mm, Titanium | \$33.00/ea |
| JOR1073LT | 32mm x 2.4mm, Titanium | \$29.70/ea |
| JOR1073MT | 34mm x 2.4mm, Titanium | \$30.00/ea |
| JOR1073NT | 36mm x 2.4mm Titanium | \$30.60/ea |
| JOR1073N | 36mm x 2.4mm Titanium | \$16.20/ea |
| JOR1073PT | 38mm x 2.4mm, Titanium | \$30.60/ea |
| JOR1073P | 38mm x 2.4mm | \$15.75/ea |
| JOR1073QT | 40mm x 2.4mm, Titanium | \$30.90/ea |

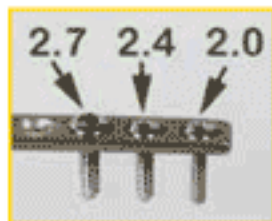

Stainless Steel

| | | |
|-----------|--------------|------------|
| JOR1073AA | 16mm x 2.4mm | \$12.00/ea |
| JOR1073BB | 8mm x 2.4mm | \$12.00/ea |
| JOR1073A | 6mm x 2.4mm | \$12.00/ea |
| JOR1073B | 12mm x 2.4mm | \$12.00/ea |
| JOR1073C | 14mm x 2.4mm | \$13.50/ea |
| JOR1073D | 16mm x 2.4mm | \$13.50/ea |
| JOR1073E | 18mm x 2.4mm | \$14.25/ea |
| JOR1073F | 20mm x 2.4mm | \$14.25/ea |
| JOR1073G | 22mm x 2.4mm | \$14.25/ea |
| JOR1073H | 24mm x 2.4mm | \$14.25/ea |
| JOR1073I | 26mm x 2.4mm | \$15.00/ea |
| JOR1073J | 28mm x 2.4mm | \$15.00/ea |
| JOR1073K | 30mm x 2.4mm | \$15.00/ea |
| JOR1073L | 32mm x 2.4mm | \$15.00/ea |
| JOR1073M | 34mm x 2.4mm | \$15.00/ea |
| JOR1073Q | 40mm x 2.4mm | \$15.75/ea |

Titanium

| | | |
|-----------|--------------|------------|
| JOR1073AT | 6mm x 2.4mm | \$27.00/ea |
| JOR1073BT | 12mm x 2.4mm | \$27.00/ea |
| JOR1073CT | 14mm x 2.4mm | \$27.00/ea |
| JOR1073DT | 16mm x 2.4mm | \$27.00/ea |
| JOR1073ET | 18mm x 2.4mm | \$27.60/ea |
| JOR1073FT | 20mm x 2.4mm | \$27.90/ea |
| JOR1073GT | 22mm x 2.4mm | \$28.20/ea |
| JOR1073HT | 24mm x 2.4mm | \$28.50/ea |
| JOR1073IT | 26mm x 2.4mm | \$28.80/ea |
| JOR1073JT | 28mm x 2.4mm | \$29.10/ea |
| JOR1073KT | 30mm x 2.4mm | \$29.40/ea |

Jorvet 2.4mm Compression Plate

| | | |
|------------|---|-------------|
| JOR1074A | 4 hole 31mm | \$52.00/ea |
| JOR1074B | 5 hole 38mm | \$56.00/ea |
| JOR1074C | 6 hole 45mm | \$60.00/ea |
| JOR1074D | 7 hole 52mm | \$64.00/ea |
| JOR1074E | 8 hole 59mm | \$68.00/ea |
| JOR1074F | 9 hole 66mm | \$80.00/ea |
| JOR1074G | 10 hole 73mm | \$92.00/ea |
| JOR1074H | 11 hole 80mm | \$101.00/ea |
| JOR1074I | 12 hole 87mm | \$111.00/ea |
| JOR1074J | 14 hole 104mm | \$123.00/ea |
| JOR1072A | 1.8mm drill bit hard | \$33.00/ea |
| JOR1072CD | 2.4 clear drill for 2.4 system | \$40.00/ea |
| JOR1073LNG | Load/Neutral Drill Guide for 2.4 system | \$252.00/ea |
| JOR412A | for 2.0mm screws, w/sleeve 1.5 hex screwdriver for 1.5, 2.0 & 2.4mm screws | \$112.00/ea |
| JOR1073SIP | Screw/Equipment box | \$312.00/ea |



2.4 PLATING KIT

- The 2.4 system is available as a boxed kit which
 - includes one of each plate, 5 of each screw up to
 - 30mm, drills, load/neutral guide and screwdriver.
- J-1073dcp 2.4 Plating Kit

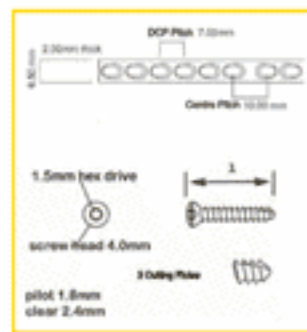

Jorvet Cortical Screws 2.7mm

2.7mm Cortical Screw. Use with 2.7mm compression and 2.7mm reconstruction plates to obtain compression at a fracture site. **Jorvet**

| | | | | | |
|---------|------------------|------------|---------|------------------|------------|
| JOR419A | 6mm Length, 6pk | \$49.50/pk | JOR419J | 24mm Length, 6pk | \$48.00/pk |
| JOR419B | 8mm Length, 6pk | \$49.50/pk | JOR419K | 26mm Length, 6pk | \$48.00/pk |
| JOR419C | 10mm Length, 6pk | \$49.50/pk | JOR419L | 28mm Length, 6pk | \$54.00/pk |
| JOR419D | 12mm Length, 6pk | \$49.50/pk | JOR419M | 30mm Length, 6pk | \$57.00/pk |
| JOR419E | 14mm Length, 6pk | \$48.00/pk | JOR419N | 32mm Length, 6pk | \$57.00/pk |
| JOR419F | 14mm Length, 6pk | \$43.50/ea | JOR419O | 34mm Length, 6pk | \$63.00/pk |
| JOR419G | 18mm Length, 6pk | \$48.00/pk | JOR419P | 36mm Length, 6pk | \$66.00/pk |
| JOR419H | 20mm Length, 6pk | \$48.00/pk | JOR419Q | 38mm Length, 6pk | \$52.50/pk |
| JOR419I | 22mm Length, 6pk | \$51.00/pk | JOR419R | 40mm Length, 6pk | \$63.00/pk |

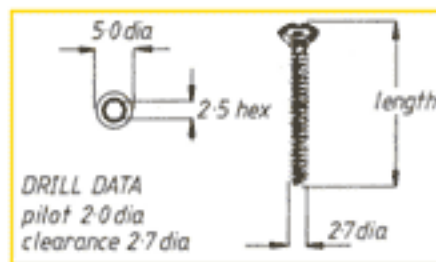

We do not stock all Orthopedic Products. Note that Jorvet/Jorgensen brand Products have a \$10 Dropship fee, as well as extra overnight fees.



Screws & Compression Plates

Jorvet Compression Plate 2.7mm

| | | | | | |
|---------|-----------------|------------|---------|-------------------|-------------|
| JOR420A | 2 holes, 20mm L | \$39.00/ea | JOR420F | 8 holes, 68mm L | \$63.00/ea |
| JOR420B | 4 holes, 36mm | \$48.00/ea | JOR420G | 9 holes, 76mm L | \$69.00/ea |
| JOR420C | 5 holes, 44mm | \$49.50/ea | JOR420H | 10 holes, 84mm L | \$78.00/ea |
| JOR420D | 6 holes, 52mm | \$54.00/ea | JOR420I | 12 holes, 100mm L | \$102.00/ea |
| JOR420E | 7 holes, 60mm L | \$63.00/ea | | | |

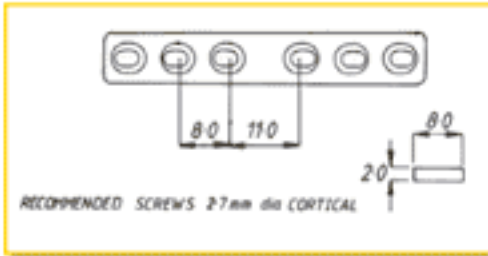

Jorvet

Jorvet Cancellous 3mm Screw

2mm pilot. 2.5 hex head. Self-tapping. Single pack.

| | | | | | |
|----------|-------------------|------------|----------|-------------|------------|
| JOR4190C | 12mm length | \$10.50/ea | JOR419JC | 24mm length | \$10.50/ea |
| JOR419EC | 14mm length | \$10.50/ea | JOR419KC | 26mm length | \$10.50/ea |
| JOR419FC | 16mm length | \$7.16/ea | JOR419LC | 28mm length | \$10.50/ea |
| JOR419GC | 18mm length, 6/pk | \$10.50/ea | JOR419MC | 30mm length | \$10.50/ea |
| JOR419HC | 20mm length | \$10.50/ea | JOR419NC | 32mm length | \$10.50/ea |
| JOR419C | 22mm length | \$10.50/ea | JOR419OC | 34mm length | \$10.50/ea |
| | | | JOR419PC | 36mm length | \$12.00/ea |

Cortical screws now available with self-tapping threads. Sold in single packs. (Add the letter "S" after each code.)

Jorvet

Self-Tapping Screws. Self-Tapping screws save time and work extremely well in most circumstances especially in the proximal tibia for TPLO and TTO. Available in 2.0, 2.4, 2.7 and 3.5mm diameters.

3.5mm Compression Plate. Use with 3.5mm cortical or 3.5mm cancellous screws to produce fracture compression.

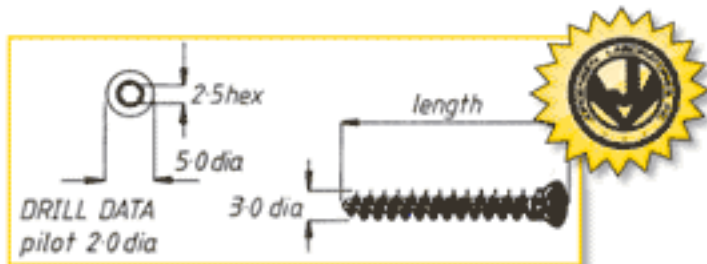

Jorvet Cortical Screws 3.5mm

This is the self-retaining bloot trocar used in chronic bloats. Make a small 3/4" incision in hide. Screw the trocar into position. After insertion, the rumen should be pulled up close to the peritoneum by placing a few wraps of gauze between the trocar plate and hide.

| | | | | | |
|---------|--------|------------|---------|--------|------------|
| JOR421A | 10mm L | \$50.00/pk | JOR421J | 28mm L | \$48.00/pk |
| JOR421B | 12mm L | \$44.00/pk | JOR421K | 30mm L | \$51.00/pk |
| JOR421C | 14mm L | \$42.00/pk | JOR421L | 32mm L | \$51.00/pk |
| JOR421D | 16mm L | \$42.00/pk | JOR421M | 34mm L | \$51.00/pk |
| JOR421E | 18mm L | \$45.00/pk | JOR421N | 36mm L | \$48.00/pk |
| JOR421F | 20mm L | \$45.00/pk | JOR421O | 40mm L | \$48.00/pk |
| JOR421G | 22mm L | \$44.00/pk | JOR421P | 45mm L | \$70.00/pk |
| JOR421H | 24mm L | \$45.00/pk | JOR421Q | 50mm L | \$73.00/pk |
| JOR421I | 26mm L | \$42.00/pk | JOR421R | 55mm L | \$88.00/pk |
| | | | JOR421S | 60mm L | \$60.00/pk |

Jorvet

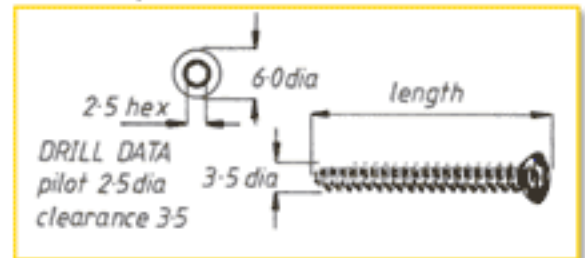

Jorvet Compression Plate 3.5mm

| | | | | | |
|---------|-----------------|------------|---------|-------------------|------------|
| JOR422A | 2 holes, 26mm L | \$48.00/ea | JOR422F | 7 holes, 86mm L | \$57.00/ea |
| JOR422B | 3 holes, 38mm L | \$49.50/ea | JOR422G | 8 holes, 98mm L | \$57.00/ea |
| JOR422C | 4 holes, 50mm L | \$48.00/ea | JOR422H | 10 holes, 122mm L | \$60.00/ea |
| JOR422D | 5 holes, 62mm L | \$57.00/ea | JOR422I | 12 holes, 146mm L | \$60.00/ea |
| JOR422E | 6 holes, 74mm L | \$57.00/ea | | | |

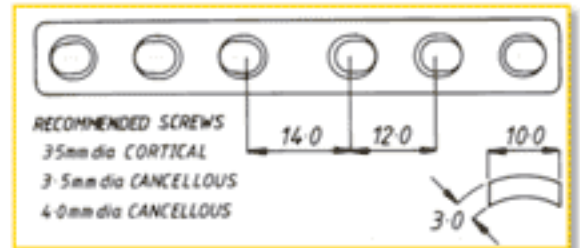

Broad Compression Plate 3.5

3.5mm Broad Compression Plate. Uses the larger width 4.5mm compression plate with holes for 3.5mm cortical screws. A heavy-duty compression plate for bigger dogs.

| | | | | | |
|----------|------------------|------------|----------|-------------------|------------|
| JOR422BA | 6 holes, 74mm L | \$54.00/ea | JOR422BE | 10 holes, 122mm L | \$78.00/ea |
| JOR422BB | 7 holes, 87mm L | \$60.00/ea | JOR422BF | 11 holes, 134mm L | \$84.00/ea |
| JOR422BC | 8 holes, 98mm L | \$69.00/ea | JOR422BG | 12 holes, 146mm L | \$90.00/ea |
| JOR422BD | 9 holes, 110mm L | \$72.00/ea | JOR422BH | 13 holes, 158mm L | \$99.00/ea |

Jorvet

We do not stock all Orthopedic Products. Note that Jorvet/Jorgensen brand Products have a \$10 Dropship fee, as well as extra overnight fees.

Orthopedic Products



Screws & Compression Plates

Jorvet Cancellous Screws 3.5mm **JorVet**

3.5mm Cancellous Screw. 1.75 Pitch. The coarser thread has a much bigger "bite" into the bone. Use on metaphyseal or other cancellous bone. The screw needs its own tap. (JOR409c)

| | | | | | |
|---------|-------------|------------|---------|-------------|------------|
| JOR423A | 10mm L, 6pk | \$36.00/pk | JOR423J | 28mm L, 6pk | \$45.00/pk |
| JOR423B | 12mm L, 6pk | \$36.00/pk | JOR423K | 30mm L, 6pk | \$51.00/pk |
| JOR423C | 14mm L, 6pk | \$36.00/pk | JOR423L | 32mm L, 6pk | \$51.00/pk |
| JOR423D | 16mm L, 6pk | \$36.00/pk | JOR423M | 34mm L, 6pk | \$51.00/pk |
| JOR423E | 18mm L, 6pk | \$36.00/pk | JOR423N | 36mm L, 6pk | \$51.00/pk |
| JOR423F | 20mm L, 6pk | \$45.00/pk | JOR423O | 40mm L, 6pk | \$75.00/pk |
| JOR423G | 22mm L, 6pk | \$45.00/pk | JOR423P | 45mm L, 6pk | \$54.00/pk |
| JOR423H | 24mm L, 6pk | \$45.00/pk | JOR423Q | 50mm L, 6pk | \$60.00/pk |
| JOR423I | 26mm L, 6pk | \$45.00/pk | JOR423R | 55mm L, 6pk | \$66.00/pk |
| | | | JOR423S | 60mm L, 6pk | \$95.00/pk |

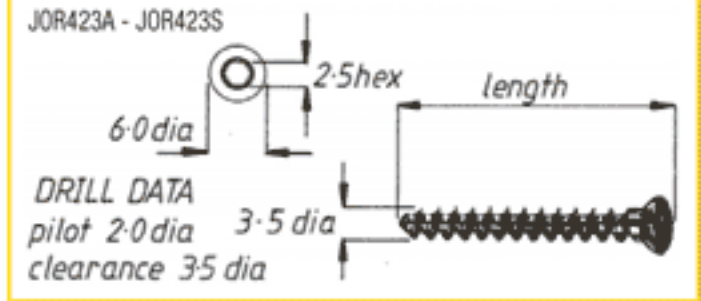

Cancellous Screw, Fully Threaded, 4.0 mm

4mm Cancellous Screw, Full Thread. Use as cancellous screws where greater screw-bone interface is desirable. 6/pk.



| | | | | | |
|---------|--------|------------|---------|--------|------------|
| JOR424A | 10mm L | \$53.00/pk | JOR424H | 24mm L | \$63.00/pk |
| JOR424B | 12mm L | \$50.00/pk | JOR424I | 26mm L | \$87.00/pk |
| JOR424C | 14mm L | \$48.00/pk | JOR424J | 28mm L | \$87.00/pk |
| JOR424D | 16mm L | \$48.00/pk | JOR424K | 30mm L | \$87.00/pk |
| JOR424E | 18mm L | \$60.00/pk | JOR424L | 35mm L | \$87.00/pk |
| JOR424F | 20mm L | \$60.00/pk | JOR424M | 40mm L | \$84.00/pk |
| JOR424G | 22mm L | \$60.00/pk | JOR424N | 45mm L | \$90.00/pk |

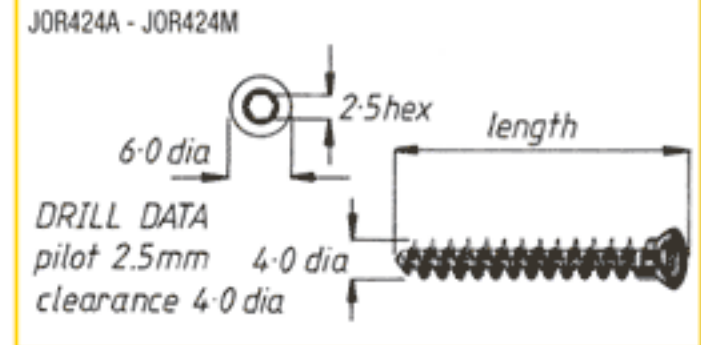

Jorvet Cancellous Lag Screw 4.0mm

4mm Cancellous (Part Threaded) Lag Screw. For use as a lag screw without overdrilling of proximal fragment. 1/pkg.



| | | | | | |
|---------|--------|------------|---------|--------|------------|
| JOR425A | 10mm L | \$7.50/ea | JOR425H | 24mm L | \$9.00/ea |
| JOR425B | 12mm L | \$9.00/ea | JOR425I | 26mm L | \$9.00/ea |
| JOR425C | 14mm L | \$7.50/ea | JOR425J | 28mm L | \$10.50/ea |
| JOR425D | 16mm L | \$9.00/ea | JOR425K | 30mm L | \$15.00/ea |
| JOR425E | 18mm L | \$9.00/ea | JOR425L | 35mm L | \$11.40/ea |
| JOR425F | 20mm L | \$12.00/ea | JOR425M | 40mm L | \$11.40/ea |
| JOR425G | 22mm L | \$9.00/ea | JOR425N | 45mm L | \$15.00/ea |

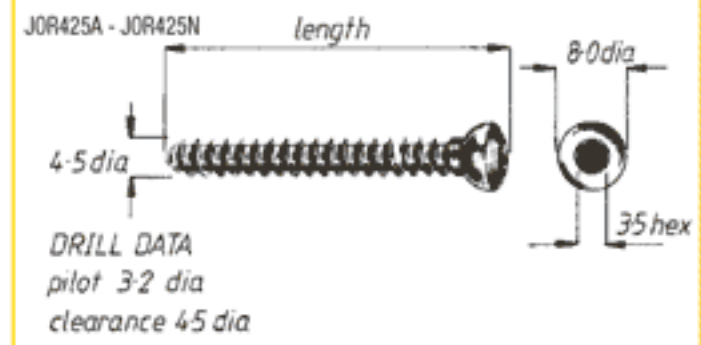

4.5mm Cortical Screw and Equipment

JOR412c Hex Screwdriver for 4.5mm screws.
JOR412cs Sleeve for above hex screwdriver.
JOR409e 4.5mm Cortical Tap.
JOR413 Tap Handle.
JOR372e 3.2mm Pilot Hole Drill bit.

JOR372h 4.5mm Clearance Drill Bit.
JOR411d Load/Neutral Drill Guide.
JOR414g Insert sleeve. 3.2-4.5mm

T-Bar tap 4.5mm Cortical

JOR409TB \$45.00/ea

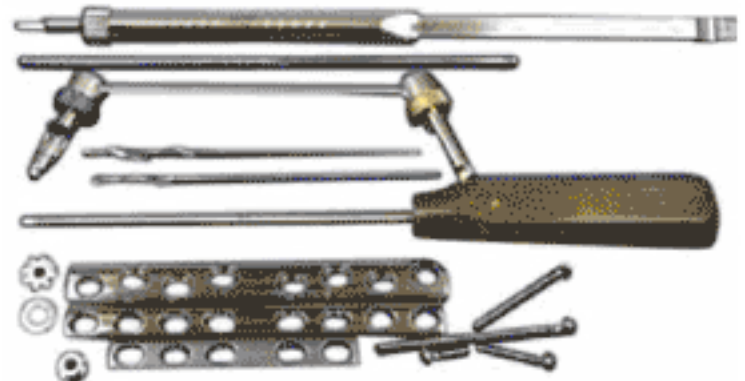

We do not stock all Orthopedic Products. Note that Jorvet/Jorgensen brand Products have a \$10 Dropship fee, as well as extra overnight fees.

13822 WEST BOULTON BLVD. METTAWA, IL 60045

WWW.SHOPMEDVET.COM

Phone 800-544-7521

249

Fax 800-204-2177

Orthopedic Products



Cortical Screws & Compression Plates

Jorvet Cortical Screws 4.5mm

4.5mm Cortical Screw. This cortical screw is suitable for very large dogs and equine patients.

| | | | | | |
|---------|--------------|------------|----------|--------------|------------|
| JOR426A | 14mm L, 6/pk | \$57.00/pk | JOR426H | 42mm L, 6/pk | \$57.00/pk |
| JOR426B | 18mm L, 6/pk | \$48.00/pk | JOR426I | 46mm L, 6/pk | \$86.00/pk |
| JOR426C | 22mm L, 6/pk | \$48.00/pk | JOR426J | 50mm L, 6/pk | \$66.00/pk |
| JOR426D | 26mm L, 6/pk | \$63.00/pk | JOR426K | 54mm L, 6/pk | \$66.00/pk |
| JOR426E | 30mm L, 6/pk | \$48.00/pk | JOR426L | 58mm L, 6/pk | \$78.00/pk |
| JOR426F | 34mm L, 6/pk | \$57.00/pk | JOR416AS | 2mm x 6mm | \$13.50/ea |
| JOR426G | 38mm L, 6/pk | \$57.00/pk | JOR416ES | 2mm x 14mm | \$12.00/ea |
| | | | JOR416FS | 2mm x 16mm | \$12.00/ea |

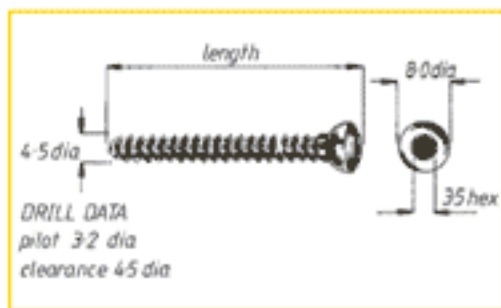

Jorvet Broad Plates 4.5mm

4.5mm Broad Plates. This is the strongest plate available for small animal orthopedics.



| | | | | | |
|----------|------------------|------------|----------|-------------------|-------------|
| JOR4270B | 5 hole, 87mm L | \$60.00/ea | JOR427KB | 13 hole, 215 mm L | \$98.00/ea |
| JOR427EB | 6 hole, 103mm L | \$63.00/ea | JOR427LB | 14 hole, 231mm L | \$105.00/ea |
| JOR427FB | 7 hole, 119mm L | \$69.00/ea | JOR427MB | 15 hole, 247mm L | \$112.00/ea |
| JOR427GB | 8 hole, 135mm L | \$75.00/ea | JOR427NB | 16 hole, 263mm L | \$116.00/ea |
| JOR427HB | 9 hole, 151mm L | \$81.00/ea | JOR427OB | 17 hole, 279mm L | \$119.00/ea |
| JOR427IB | 10 hole, 167mm L | \$88.00/ea | JOR427PB | 18 hole, 295mm L | \$130.00/ea |
| JOR427JB | 12 hole, 199mm L | \$96.00/ea | | | |



Broad 4.5mm Compression Plate

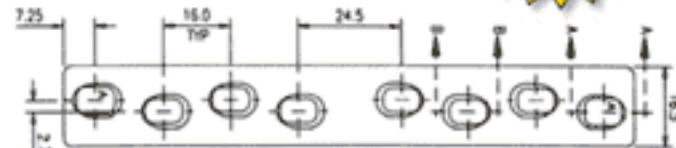

Jorvet Compression Plate 4.5mm

Use with 4.5mm cortical screws to produce fracture-site compression.

| | | | | | |
|---------|------------------|------------|---------|-------------------|------------|
| JOR427C | 4-hole, 71mm L | \$45.00/ea | JOR427G | 9 holes, 151mm L | \$75.00/ea |
| JOR427A | 2 holes, 39mm L | \$30.00/ea | JOR427H | 10 holes, 167mm L | \$81.00/ea |
| JOR427B | 3 holes, 55mm L | \$36.00/ea | JOR427I | 11 holes, 183mm L | \$86.00/ea |
| JOR427D | 5 holes, 87mm L | \$51.00/ea | JOR427J | 12 holes, 199mm L | \$90.00/ea |
| JOR427F | 8 holes, 135mm L | \$69.00/ea | JOR427E | 6-hole, 103mm L | \$59.00/ea |

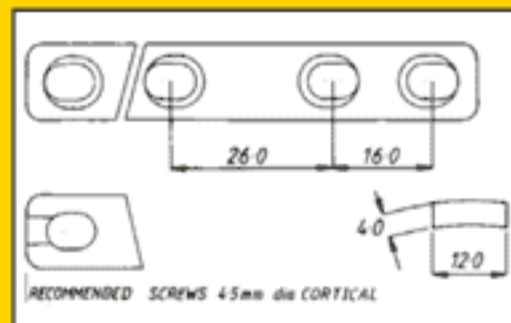

Acetabular Bone Plates

| | | |
|---------|---|-------------|
| JOR373A | Very Small Plate, Uses 2.0mm screws, 4 hole | \$72.00/ea |
| JOR373B | Small plate, Uses 2.0mm screws, 4 hole | \$72.00/ea |
| JOR373C | Medium plate, Uses 2.7mm screws, 6 hole | \$87.00/ea |
| JOR373D | Large plate, Uses 2.7mm screws, 6 hole | \$87.00/ea |
| JOR373E | X-Large plate, Uses 3.5mm screws, 6 hole | \$101.00/ea |
| JOR373F | XX-Large plate, Uses 3.5mm screws, 6 hole | \$101.00/ea |



Jorvet Carpal Arthrodesis Plates

| | | |
|-----------|--|-------------|
| JOR428H | Round Hole 2.7mm/3.5mm, 112mm | \$86.00/ea |
| JOR428J | Compression, 2.7mm/3.5mm, 112mm | \$114.00/ea |
| JOR428JXL | Extended length to increase over metacarpals, 2.7mm/3.5mm, 118mm | \$114.00/ea |
| JOR428K | Compression, 2.0mm/2.7mm, 75mm | \$114.00/ea |
| JOR428L | Round-Hole, 2.0mm/2.7mm, 75mm | \$86.00/ea |
| JOR428M | Broad Compression, 3.5mm/3.5mm, 140mm | \$114.00/ea |
| JOR428N | Broad Round-Hole, 3.5mm/3.5mm, 140mm | \$110.00/ea |
| JOR428W | Carpal Arthrodesis, 1.5/2.0mm DCP, 54mm | \$110.00/ea |
| JOR428Y | Carpal Arthrodesis 2.2mm DCP | \$109.00/ea |
| JOR428Z | Intertarsal Arthrodesis PL, 2/2.7mm | \$117.00/ea |

We do not stock all Orthopedic Products. Note that Jorvet/Jorgensen brand Products have a \$10 Dropship fee, as well as extra overnight fees.

13822 WEST BOULTON BLVD. METTAWA, IL 60045

WWW.SHOPMEDVET.COM

Phone 800-544-7521

250

Fax 800-204-2177

Orthopedic Products

Bone Plates

Jorvet "T"-Plate

Available for 3.5, 2.7, and 2.0mm screws, either cortical or self-tapping. "T" plates are used almost exclusively for the repair of fractures of the distal radius. In addition, they also may be used in a partial carpal arthrodesis.



| | | |
|---------|----------------------------------|------------|
| JOR428A | 2mm, 4 hole, 18mm L | \$34.50/ea |
| JOR428B | 2.0mm, 4-hole. Left angle, 18mm | \$27.00/ea |
| JOR428C | 2.0mm, 4-hole. Right Angle. 18mm | \$27.00/ea |
| JOR428D | 2.7mm, 5-hole, 32mm | \$27.00/ea |
| JOR428E | 2.7mm, 5 hole Left Angled, 32mm | \$28.50/ea |
| JOR428F | 5 Hole Right Angle, 32mm | \$28.50/ea |
| JOR428G | 3.5mm, 6 hole, 55mm | \$49.00/ea |



Hybrid "T" Plates

The problem with many distal radius fractures is the distal segment is so small that it is difficult to place sufficient screws. A "T" plate can help but often the head of the plate is too wide. Hybrid "T" plates can provide a solution.

- Screw holes in the head are smaller and closer together than those in the shaft
- Plate will accept same size screw in the head as in the shaft, but with reduced screw angulations

| | | |
|---------|--|------------|
| JOR829A | 1.5 or 2mm head 2mm shaft 32mm length of shaft | \$86.00/ea |
| JOR829 | 2.7 or 3.5mm head 3.5mm shaft 62mm length of shaft | \$92.00/ea |



Pantarsal Arthrodesis Plate.

The surgical immobilization of the hock joint can be difficult. A medially applied plate appears to best neutralize the effect of the long lever arm created by arthrodesis. Data from the manufacture of 50 custom plates has enabled Jorvet to create a pantarsal plate which fits most medium and large dogs. The proximal portion is standard 3.5mm DCP, broadening over the vulnerable calcaneal region, and finally tapering out over the metatarsals as a 2.7mm DCP.

| | | |
|---------|-------------------|-------------|
| JOR433A | left, 2.7 / 3.5mm | \$165.00/ea |
|---------|-------------------|-------------|

Pantarsal Arthrodesis Plate

For small dogs. Overall length 100mm. 2.7mm/2.0mm screws.

| | | |
|----------|-------|-------------|
| JOR433BL | Left | \$150.00/ea |
| JOR433BR | Right | \$150.00/ea |

Our pantarsal plate is 135° with the middle screw placed in the center of the talus or the center of motion of the joint. This is not a one size fits all, but the only alternative is a custom plate. For cats. Overall length 78mm. 120° angle, better to match feline anatomy especially useful for severe shearing injuries. 2.7mm/2.0mm screw

| | | |
|----------|---------------------------|-------------|
| JOR433CL | Left, 2.0mm, 2.7mm | \$150.00/ea |
| JOR433CR | Right, Left, 2.0mm, 2.7mm | \$150.00/ea |
| JOR433 | Right, 2.7 / 3.5mm | \$158.00/ea |

Intertarsal Arthrodesis Compression Plate

is slightly wider and the holes are positioned to cover the metatarsal more completely. Middle hole picks up the central tarsal bone and T4. 2.0mm/2.7mm (sheltie size). (not pictured) 55mm.

| | | |
|---------|-------------------------------------|-------------|
| JOR428Z | Intertarsal Arthrodesis PL, 2/2.7mm | \$117.00/ea |
|---------|-------------------------------------|-------------|

Jorvet Distal Femur Plate

Fracture repair in the supracondylar femur region can be challenging, particularly in medium to large dogs. Forces acting on this region are complex and must be neutralized. In addition, the bone shape makes the use of standard plates virtually impossible. Jorvet supracondylar plates are designed to fit the distal femur with a minimum of further contouring. These plates are curved on the distal end to follow the natural bone curvature. The plate thickness tapers distally from 1.5mm to 1mm on 2mm plates. In cats and small dogs supracondylar fractures are usually simple and transverse, hence the 2mm plates are relatively lightweight. Medium and larger dogs typically have more complex fractures at this site with multiple fragments, requiring much more plate support. Our 2.7 and 3.5 plate's shape and strength reflect this. Apply the plate when possible to the lateral surface of the femur.

| | | |
|---------|--|-------------|
| JOR428P | 2.0mm Supracondylar Plate, Left, 50mm L | \$93.00/ea |
| JOR428Q | 2.0mm Supracondylar Plate, Right, 50mm L | \$93.00/ea |
| JOR428R | 2.7mm Supracondylar Plate, Right, 70mm | \$139.00/ea |
| JOR428S | 2.7mm Supracondylar Plate, Left, 70mm | \$139.00/ea |
| JOR428T | 3.5mm Supracondylar Plate, Right, 170mm | \$226.00/ea |
| JOR428U | 3.5mm Supracondylar Plate, Left, 170mm | \$220.00/ea |

Supra Condylar Osteotomy Plates (SCOP)

Osteotomy of the distal femur is now a recognized technique for the management of patella luxation in medium and larger dogs with added femoral abnormality. The use of straight plates is difficult due to hole positioning and plate contouring. These supra condylar plates are computer designed to fit this area. Pre-contoured to minimize intra operative adjustments. For complex supra condylar fractures use our large supra condylar plates or distal femoral plates (see above).

| | | |
|----------|--------------|-------------|
| JOR1076 | 2.7mm right | \$135.00/ea |
| JOR1076A | 2.7mm left | \$135.00/ea |
| JOR1076B | 3.5 mm right | \$168.00/ea |
| JOR1076C | 3.5mm left | \$168.00/ea |

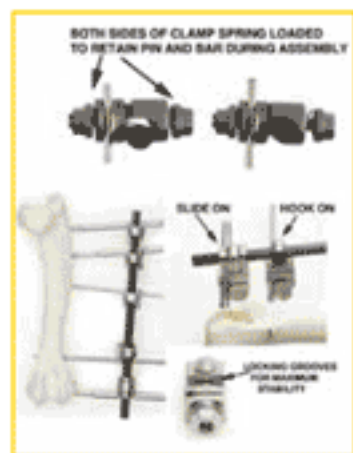

We do not stock all Orthopedic Products. Note that Jorvet/Jorgensen brand Products have a \$10 Dropship fee, as well as extra overnight fees.

13822 WEST BOULTON BLVD. METTAWA, IL 60045

WWW.SHOPMEDVET.COM

Phone 800-544-7521

251

Fax 800-204-2177



Orthopedic Products

Bone Plates & Gauzges

Tibial Wedge Osteotomy Plate

These "T" plates are designed with 3 round holes in the top of the "T" and compression holes along the length of the shaft.



| | | |
|---------|------------------------------------|-------------|
| JOR822A | 6-holes. 39mm L. Uses 2.7mm screws | \$75.00/ea |
| JOR822B | 6-holes. 55mm L. Uses 3.5mm screws | \$103.00/ea |
| JOR822C | 7-holes. 79mm L. Uses 3.5mm screws | \$103.00/ea |
| JOR822D | 6-holes. 26mm L. Uses 2.0mm screws | \$35.00/ea |

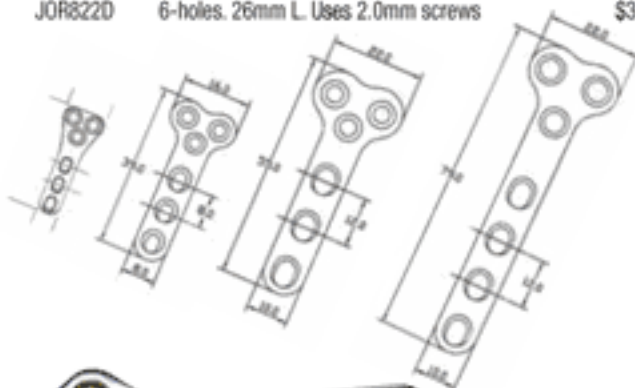

Standard TPLO Plate

JorVet version of the original TPLO plates.

- Made of 316LVM implant grade stainless steel
- Milled, not cast The JorVet plate has been modified in the head region to make contouring easy while retaining the stiffness of 316LVM elsewhere for stability and rapid healing. The lower profile makes closure easier.

| | | |
|---------|--------------|------------|
| JOR438 | 3.5mm, Left | \$87.00/ea |
| JOR438A | 3.5mm, Right | \$87.00/ea |
| JOR438B | 2.7mm, Left | \$87.00/ea |
| JOR438C | 2.7mm, Right | \$87.00/ea |



Standard TPLO Pre Contoured Plates

Standard TPLO pre contoured plates. Made of 316LVM milled material that is pre contoured for easy application.



| | | |
|----------|---------------------------|------------|
| JOR438AC | 3.5mm Precontoured, Right | \$92.00/ea |
| JOR438BC | 3.5mm precontoured left | \$92.00/ea |

Standard TPLO Pre Contoured Plates.

TPLO Guide Pin. End threaded negative pin. Drive directly into tibia for attachment of TPLO jig 3.2mm diameter with 25mm thread lengths.

| | |
|----------|------------|
| JOR438GP | \$13.50/ea |
|----------|------------|

Self-Tap Plating Case w 2.7/3.5mm Screw Rack

Stainless Steel Case. 2.7/3.5mm screw rack



| | |
|---------|-------------|
| JOR430D | \$325.00/ea |
|---------|-------------|



Biological Healing Plates



These plates are designed to bridge a section of shattered long bone. It effectively acts as a buttress plate. No attempt is made to reconstruct. The fracture site is not disturbed to minimize de-vitalization and contamination. The plate maintains the length and permits weight bearing. Use of these plates avoids leaving empty screw holes over the fracture site. Empty holes significantly weaken the construct. Use when proximal and distal sections are intact and the body of the femur are un-reconstructable. All plates have round holes as there is no need for compression.

| | | |
|---------|---|------------|
| JOR433D | 2.0mm 8 hole 65mm long - 6mm wide | \$51.00/ea |
| JOR433E | 2.7mm 6 hole 68mm long - 7mm wide | \$57.50/ea |
| JOR433F | 2.7mm 7 hole 67mm long - 7mm wide | \$57.50/ea |
| JOR433G | 2.7mm 8 hole 75mm long - 7mm wide | \$57.50/ea |
| JOR433H | 3.5mm 7 hole 120mm long - 10mm wide | \$57.50/ea |
| JOR433J | 3.5mm 8 hole 130mm long - 10mm wide | \$57.50/ea |
| JOR433K | 4.5mm 7 hole 138mm long - 10mm wide | \$63.75/ea |
| JOR433M | 4.5mm 8 hole 150mm long - 10mm wide | \$63.75/ea |
| JOR433N | 3.5mm 8 hole (Broad) 130mm long - 10mm wide | \$69.00/ea |

Jorvet Bone Plate Clip

The storage of plates in an orderly fashion is desirable. This inexpensive clip allows plate storage with quick access while making proper plate selection easier.

- Holds up to eight plates
- ID tag identifies each plate size

| | | |
|-----------|-------|------------|
| JOR430PC | 3.5mm | \$19.80/ea |
| JOR430PCA | 2.7mm | \$19.80/ea |
| JOR430PCB | 2.0mm | \$19.80/ea |



Jorvet TPLO Jig

JOR438J

| | |
|---------|-------------|
| JOR438J | \$320.00/ea |
|---------|-------------|



Jorvet Delta Style TPLO Plates (Precontoured)

These precontoured triangular TPLO plates keep additional bending to a minimum. Available in a wide range of sizes.

| | | |
|---------|----------------------|-------------|
| JOR439 | 3.5mm standard left | \$94.00/ea |
| JOR439A | 3.5mm standard right | \$94.00/ea |
| JOR439B | 2.7mm left | \$93.00/ea |
| JOR439C | 2.7mm right | \$93.00/ea |
| JOR439D | 3.5mm broad left | \$102.00/ea |
| JOR439E | 3.5mm broad right | \$102.00/ea |
| JOR439F | 2.4mm left | \$93.00/ea |
| JOR439G | 2.4mm right | \$93.00/ea |



Long T Plate



| | | |
|---------|-------------------|------------|
| JOR439T | 2.4mm 7 hole 52mm | \$84.00/ea |
|---------|-------------------|------------|

We do not stock all Orthopedic Products. Note that Jorvet/Jorgensen brand Products have a \$10 Dropship fee, as well as extra overnight fees.

13822 WEST BOULTON BLVD. METTAWA, IL 60045

WWW.SHOPMEDVET.COM

Phone 800-544-7521

252

Fax 800-204-2177



Suture Screw/Anchor **JorVet**

Suture anchors have many uses, particularly reattachment of a ligament to bone. A screw is placed into bone and the head of the screw has an eyelet for suture placement. The screws are self-tapping after placement of a smaller pilot hole. A special driver is used to insert the screw. Suggested uses include:

- Coxo femoral luxations
- Shearing injuries
- Collateral ligament repairs
- Anchor for CCL lateral sutures

| | | |
|---------|--|------------|
| JOR836 | Cortical Screw, 2.0mm, 10mm L, 1.0mm eyelet dia., 1.5mm pilot hole | \$30.50/ea |
| JOR836A | Cortical Screw, 14mm L, 1.5mm eyelet dia, 2.0mm pilot hole | \$30.50/ea |
| JOR836B | Cortical Screw, 20mm L, 2.0mm eyelet dia, 2.5mm pilot hole | \$30.50/ea |
| JOR836C | Cortical Screw, 24mm L, 2.0mm eyelet dia, 2.0mm pilot hole | \$30.50/ea |
| JOR836D | Cortical Screw, 6mm L, 1.0mm eyelet dia, 1.5mm pilot hole | \$30.50/ea |
| JOR836E | Cortical Screw, 8mm L, 1.5mm eyelet dia, 2.0mm pilot hole | \$30.50/ea |
| JOR836F | Cortical Screw, 12mm L, 2.0mm eyelet dia, 2.5mm pilot hole | \$30.50/ea |

Also Required

| | | |
|---------|-----------------------------|-------------|
| JOR837 | Screw Insertion Tool, 2mm | \$111.00/ea |
| JOR837A | Screw Insertion Tool, 2.7mm | \$98.00/ea |



Bone Plate Press **JorVet**

The JorVet Bone Plate Press is designed for small animal plates and will fit in your autoclave. 2.7-4.5 narrow 12" long

| | | |
|----------|-------|-------------|
| JOR431LP | Large | \$330.00/ea |
|----------|-------|-------------|

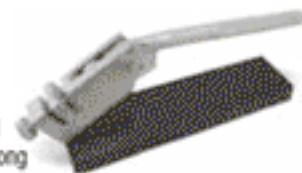

Jorvet Extra Large Bone Plate Press

Very large 16" (410mm) overall length. Suitable for 2.7- 4.5mm broad plates. Wide anvil.

| | | |
|----------|------------|-------------|
| JOR431XL | Wide Anvil | \$340.00/ea |
|----------|------------|-------------|



Jorvet Cortical Self-Tapping Screw

| | | |
|----------|------------|------------|
| JOR416AS | 2mm x 6mm | \$13.50/ea |
| JOR416ES | 2mm x 14mm | \$12.00/ea |
| JOR416FS | 2mm x 16mm | \$12.00/ea |

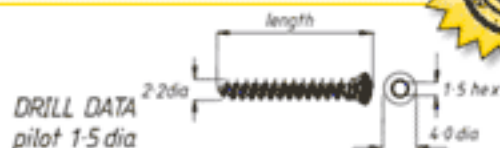

We do not stock all Orthopedic Products. Note that Jorvet/Jorgensen brand Products have a \$10 Dropship fee, as well as extra overnight fees.

TPLO 3.5mm Locking Screw Pre Contoured Plate **JorVet**

The latest generation of TPLO plates involves the use of locking screws. The head of these special screws are threaded to coincide with threads on the inside of the plate hole. JorVet locking screws are made to international standards.

| | | |
|----------|----------------|-------------|
| JOR438AL | Left, 5mm | \$114.00/ea |
| JOR438BL | Right, 3 3.5mm | \$114.00/ea |

Locking Screws 3.5mm

(uses 2.7 mm pilot drill bit)

| | | |
|----------|--|------------|
| JOR438LK | 30mm | \$31.00/ea |
| JOR438LM | 32mm | \$32.50/ea |
| JOR438LN | 34mm | \$32.50/ea |
| JOR438LP | 36mm | \$34.00/ea |
| JOR438LQ | 38mm | \$35.50/ea |
| JOR438LD | 18mm | \$29.00/ea |
| JOR438LE | 20mm | \$29.00/ea |
| JOR438LF | 22mm | \$29.00/ea |
| JOR438LG | 24mm | \$31.00/ea |
| JOR438LH | 26mm | \$31.00/ea |
| JOR438LJ | 28mm will work on other brand of locking TPLO plates | \$31.00/ea |



TPLO Plate

"Y" style plate made by Aesculap. This plate has 3 compression screw holes. It works well when the proximal section will not fit a standard TPLO fit. Pre contoured.

| | | |
|---------|-------------------|-------------|
| JOR438S | Left Standard | \$119.00/ea |
| JOR438T | Right Standard | \$119.00/ea |
| JOR438Y | Plate Left Broad | \$144.00/ea |
| JOR438Z | Plate Right Broad | \$144.00/ea |



Locking Screw Drill Guide

The locking screw requires precise drilling to match threaded screw head to plate. It is essential to screw the guide into the plate prior to drilling the pilot hole.

| | |
|----------|------------|
| JOR438DG | \$92.00/ea |
|----------|------------|



Locking Plug for TPLO Locking Screw

Used to protect locking holes while contouring plate

| | |
|---------|------------|
| JOR438P | \$16.00/ea |
|---------|------------|

- Holes 4, 5, and 6 are for locking screws.
- Holes 1, 2 and 3 are for standard cortical screws.



Orthopedic Products

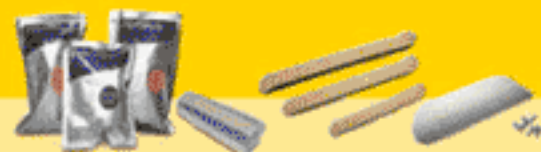

Osteotomy Kit & Cruciate Staples

Triple Tibial Osteotomy Kit **Jorvet**

Kit Includes:

- (1) JOR436a Osteotometer
- (1) JOR436w Osteotomy Wedge
- (1) JOR436g Saw Guide
- (1) JOR436d DVD

JOR436 \$380.00/ea

Jorvet



Saw Guide for TTO **Jorvet**

JOR436G \$135.00/ea

Osteotomy Wedge **Jorvet**

JOR436W \$135.00/ea

Osteometer for TTO **Jorvet**

JOR436A \$135.00/ea



Wedge Osteotomy Gauge Set **Jorvet**

These 14 wedge gauges (8-22°) simplify marking and cutting of an appropriate wedge. Parallel marks on each gauge allow the surgeon to mark and cut a wedge having equal proximal and distal borders. Borders the same length result in a better closure both functionally and cosmetically.

JOR822S 14 Wedge Gauges (8-22°) \$120.00/ea



Wedge Angle Finder Overlay **Jorvet**

A simple acetate overlay helps calculate the tibial plateau angle from which you can easily calculate the size of the wedge to remove. Included lines indicate the normal tibial plateau angle, and a 5° line, regarded as the most appropriate post-op angle. Also on the acetate are actual size outlines of range of TPLO plates to help you select the most appropriate plate.

JOR822X Call For Pricing



Triple Osteotomy Plate **Jorvet**

6-hole plate with 2 holes allowing compression designed specifically for triple osteotomy procedures. For use with 3.5mm x 4.0mm screws. Easily bend plate into desired angle.

| | | |
|---------|---|------------|
| JOR216 | 4.5cm L. Flat. | \$76.00/ea |
| JOR216A | TPO Large Plate, pre-bent, 30° - left side, length 48mm | \$85.00/ea |
| JOR216B | TPO Large Plate, pre-bent 30° - right side, 48mm | \$85.00/ea |
| JOR216C | TPO Small Plate, prebent 30° - left side, 35mm | \$85.00/ea |
| JOR216D | TPO small plate, prebent 30° - right side, 35mm | \$85.00/ea |



Slocum/TPLO Rotation Gauge **Jorvet**

Eleven rotation gauges simplify the TPLO rotation procedure. Correct millimeter measurement readings from the table assists selecting an appropriate gauge. Then mark the bone using the JOR822t scriber or an osteotome. No more need to work with cumbersome rulers. These 5-15mm gauges are on a handy -key ring.

JOR822F rotation gauge \$101.00/ea



Jorvet Cruciate Staples **Jorvet**

Spikes under the head trap the autografts. Barbs on the legs prevent pull out. Cruciate staples provide very secure fixation of fascial autografts behind the femoral condyle. Any mallet can be used to drive the staple into the bone.

JOR838 Staple Introducer. Jaws of staple introducer engage grooves in head of staple giving a very firm grip allowing accurate staple placement. \$210.00/ea

JOR838K Includes Introducer Plus 8 Staples \$750.00/ea

JOR835M Stainless Steel Case Only (for staple kit) \$234.00/ea



We do not stock all Orthopedic Products. Note that Jorvet/Jorgensen brand Products have a \$10 Dropship fee, as well as extra overnight fees.

13822 WEST BOULTON BLVD. METTAWA, IL 60045

WWW.SHOPMEDVET.COM

Phone 800-544-7521

254

Fax 800-204-2177

Orthopedic Products

Epoxy ESF Putty & Technovit



Epoxy ESF Putty **Jorvet**

This putty offers a quick and simple alternative to standard bar and clamp systems. The putty, once mixed, stiffens in five minutes and within one hour is fully cured. The putty comes in a round protective resealable 3/4" dia. tube. The amount required can be clipped off just like cookie dough. It has a pre-measured catalyst that is activated upon kneading or mixing.

Features:

- No liquid and powder mixing required
- No odor
- Immediately very moldable to shape
- Inexpensive compared to clamps/bars
- Applications:
- Different size pin placed at varying angles
- ESF in very small animals (i.e., guinea pig)
- Fractures of the mandible
- Protecting sharp ends of cut pins
- Joining non-standard pins and bars



| | | |
|---------|------------|------------|
| JOR751 | 55g, Tube | \$7.50/ea |
| JOR751A | 110g, Tube | \$16.50/ea |



Protection of Cut Ends of Pins



Stabilization of Opening Wedge Osteotomy



Stabilization of Bilateral Mandibular Fracture



Stabilization of Medial Shearing Injury Hock



Fractured Tibia in a Cat



Tarsal-Metatarsal Arthrodesis



Fractured Tibia in a Guinea Pig

Bone cement is a sterile form of Polymethyl Methacrylate (PMMA) originally formulated for use in hip replacement. It is available with or without antibiotics and a range of viscosities. In addition to hip replacement bone cement, veterinarians have found a wide range of other applications. There are two types that offer different viscosities for different applications. All consist of liquid/powder portions that are mixed together. Now includes sterile mixing bowls with spatula. This makes the process much easier with better odor control.

Bone Cement Type 1: Medium Viscosity

Type 1: Medium Viscosity forms a digitally (finger) malleable putty.

Applications:

- Cement the acetabular component of a hip replacement
- Adjunct to acetabular fracture with pins and screws
- Spinal fractures
- Management of cervical wobblers by distraction fusion
- Filling dead space in equine tooth extractions
- Manufacturing of antibiotic impregnated beads (AIPMMA)
- Choose to add one's choice of suitable antibiotic or pre-added gentamycin, creating a slow release focal antibiotic. Especially useful in the management of refractory rabbit abscesses. Instructions included.



| | | |
|---------|---------------------------|-------------|
| JOR912 | 40gm | \$114.00/ea |
| JOR912G | 40gm with 1gm Gentamycin. | \$110.00/ea |



Bone Cement Type II: Low Viscosity **Jorvet**

When mixed, is suitable for use through a syringe with a large catheter tip. Applications: Cementing the femoral prosthesis



| | | |
|---------|-----------------------------|-------------|
| JOR913 | 40gm | \$108.00/ea |
| JOR913G | 40gm with 1gm of Gentamycin | \$113.00/ea |

Jorvet Technovit Dual Pouch

Technovit: A powder and liquid that when mixed together form a hard acrylic. Methyl methacrylate compound is getting widespread use in veterinary medicine in a number of different applications. These forms require smaller, more specialized packaging than the standard hoof applications. Two relatively new uses include:

1. Acrylic in place of a connecting bar in the use of an external fixator. The acrylic can be shaped to follow body contours. An additional requirement is a tube-shaped container for holding the acrylic's shape while it cures.
2. A second use is in mixing an antibiotic powder together with the acrylic powder portion. Then the liquid portion is mixed in. The resulting mixture is shaped into very small beads that can be strung together like a string of pearls. The beads can be inserted into certain types of refractory wounds or abscesses. The bead acts as a time-release capsule for the antibiotic. The antibiotic leeches out directly into the infection site. The acrylic remains inert and is removed at a later date. The product is packaged in a heavy-duty 3ml sealed bag. The powder and liquid are separated by a plastic removable divider.

| | | |
|---------|---------------------------------|------------|
| JOR860 | 30ml Liquid Pouch/50gm Powder | \$13.50/ea |
| JOR860A | 60ml Liquid Pouch/100gm Powder | \$16.50/ea |
| JOR860B | 120ml Liquid Pouch/200gm Powder | \$24.00/ea |



Technovit (for external fixation use)

- JOR861 Single Tube Configuration Kit Includes: 60ml liquid pouch/100gm powder, 8" section of plastic hollow tube, 22mm, 2 plastic caps. Instructions for use \$18.00/ea
- JOR861A Small Single Tube Configuration Kit Includes: 30ml liquid pouch/50gm powder • 6" section of plastic hollow tube, 15mm, 2 plastic caps. Instructions for use \$18.00/ea
- JOR862 Two-Tube Configuration Kit Includes: 120ml liquid pouch/200gm powder, 18" section of plastic hollow tube, 22mm, 4 plastic caps. Instructions for use \$30.00/ea
- JOR862A Small Two-Tube Configuration Kit Includes: 60ml liquid pouch/100gm powder, 18" section of plastic hollow tube, 15mm, 4 plastic caps. Instructions for use \$24.00/ea

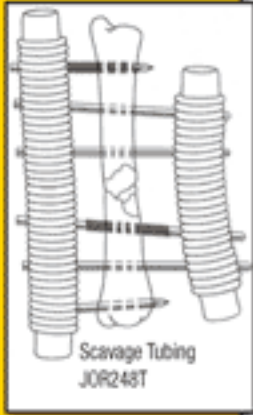

We do not stock all Orthopedic Products. Note that Jorvet/Jorgensen brand Products have a \$10 Dropship fee, as well as extra overnight fees.

Orthopedic Products

Fixation Supplies



Jorvet Surgical Instrument Guards

Jorvet instrument guards are designed to protect valuable instrument tips from damage during sterilization and handling. Sharp and pointed tips can break through sterilization pouches and injure the surgeon. 50/pkg.

- Non-sterile, but can be autoclaved or gas sterilized
- Medical-grade plastic (vented)
- Guards can also work as covers over exposed bone pins.

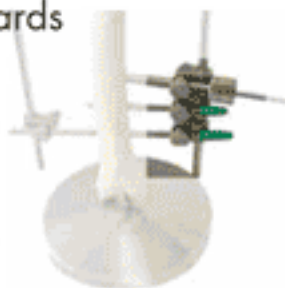

Jorvet

| | | |
|---------|------------------------------------|------------|
| JOR926A | White, 1/16" x 3/4" (1.6mm x 19mm) | \$13.80/ea |
| JOR926B | Blue, 5/64" x 3/4" (2.0mm x 19mm) | \$13.50/ea |
| JOR926C | Green, 7/64" x 3/4" (2.8mm x 19mm) | \$14.10/ea |
| JOR926D | Red, 1/8" x 1" (3.2mm x 25mm) | \$14.10/ea |

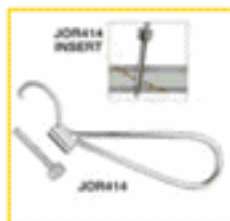

Drill Guide and Insert

| | | |
|---------|--|-------------|
| JOR414 | Small. 3.5mm i.d. For 3.5mm drill bit. | \$124.00/ea |
| JOR414E | Large. 6.5mm i.d. For use with JOR414g insert sleeve and 4.5mm screw system. | \$99.00/ea |

Jorvet Soft Tissue Protection Sleeve

Rotating pins, drills and taps will "pick up" soft tissue, skin, muscle, nerves and blood vessels, causing serious damage. Use of tissue protection sleeves minimizes such damage. The teeth at the top of the guide locate on the bone while the stainless steel tube provides a barrier between soft tissue and implant equipment.

| | | |
|---------|-------------------------|-------------|
| JOR415A | for drill/taps to 2.0mm | \$102.00/ea |
| JOR415B | for drill/taps to 2.7mm | \$98.00/ea |
| JOR415C | for drill/taps to 3.5mm | \$99.00/ea |
| JOR415D | for drill/taps to 4.5mm | \$100.00/ea |



Jorvet Countersinks

This instrument contours the top of the screw hole to fit the screwhead. It is used for lag screw procedures and for the reattachment of small bone fragments.

| | | |
|----------|---|-------------|
| JOR372W | Small Countersink, 2.7/3.5 and 4.0mm. Screw Heads with T-handle | \$82.00/ea |
| JOR372Y | Large countersink, 4.5 and higher screw., Quick Coupling End | \$101.00/ea |
| JOR409LH | Large countersink, T handle, 4.5-6.5mm | \$86.50/ea |

Quick Release Tap Handle

Quick Release Tap Handle Synthes Fit. Fits all taps 2.7mm, 3.5mm, 4.0mm, and 4.5mm.

| | | |
|--------|---------------|-------------|
| JOR413 | 2.7mm - 4.5mm | \$238.00/ea |
|--------|---------------|-------------|



Small Pin/Tap Chuck

| | | |
|---------|------------------------|-------------|
| JOR214S | for 2mm taps 4" length | \$111.00/ea |
|---------|------------------------|-------------|



Jorvet KE Plus clamp

Kirschner-Ehmer (KE) external fixation is a versatile system that has stood the test of time. Recent recommendations include the use of positive or raised profile pins. Traditional or standard KE clamps are difficult to use with positive profile pins. Also, standard KE clamps can only be used with one size pin. The new KE Plus Clamp can be used with positive profile and various sized pins.

| | | |
|----------|---|------------|
| JOR371AD | Small, Largest Thread/Shank 3.6mm (9/64") Smallest Thread/Shank 0.9mm (1/16") | \$30.00/ea |
| JOR371BD | Medium, Largest Thread/Shank 4.8mm (3/16") Smallest Thread/Shank 2.4mm (7/64") | \$33.00/ea |
| JOR371CD | Large, Largest Thread/Shank 6.5mm (1/4") Smallest Thread/Shank 3.0mm (1/8") | \$33.00/ea |

Jorvet Split KE Clamp

The reduction and stabilization of complicated fractures is a time consuming procedure. If additional clamps and pins are found to be needed during surgery the whole frame must be disassembled. The split clamp allows the addition of clamps at any time during the surgery. A centrally placed washer increases holding power.

| | | |
|-----------|--------|------------|
| JOR371SCL | Large | \$60.00/ea |
| JOR371SCM | Medium | \$60.00/ea |
| JOR371SCS | Small | \$60.00/ea |



Jorvet KE Tissue Protector

Soft tissue protection is extremely important during the insertion of KE bone pins. Without soft tissue protection there is a tendency for soft tissue structures such as muscle, blood vessels, and nerves to be wrapped around the pin. This tendency is greatly increased with the use of raised threaded pins or drill bits. Other drill guides and tissue protectors will work when placing free standing pins. However, when placing pins in the middle of a KE frame, they can not be used.

| | | |
|----------|-----|------------|
| JOR371TP | 7"L | \$85.00/ea |
|----------|-----|------------|



Insert Sleeve (for Drill Guide)

| | | |
|----------|--|-------------|
| JOR414AA | 2.0mm i.d. 1.5 for screw: 2.0mm Cortical JOR416 a-j. Fits inside JOR414a. | \$90.00/ea |
| JOR414A | 3.5mm i.d. 2.0 for screw: 3.5mm Cancellous JOR423a-s* | \$90.00/ea |
| JOR414BB | 3.5mm i.d. 2.5 for screw: 3.5mm Cortical JOR421 a-j* | \$90.00/ea |
| JOR414B | 3.5mm i.d. 2.7 for screw: 3.5mm Self-Tapping JOR406a-o* | \$86.00/ea |
| JOR414G | 4.5mm i.d. 3.2 for screw: 4.5mm Cortical Screw JOR426a-L plus Drill Sleeve JOR414f | \$105.00/ea |
| JOR414F | 6.5mm i.d. 4.5 for use with Drill Guide JOR414e | \$105.00/ea |

We do not stock all Orthopedic Products. Note that Jorvet/Jorgensen brand Products have a \$10 Dropship fee, as well as extra overnight fees.

13822 WEST BOULTON BLVD. METTAWA, IL 60045

WWW.SHOPMEDVET.COM

Phone 800-544-7521

256

Fax 800-204-2177



Jorvet TTA Plate Bender

JOR1072B \$156.00/ea



Jorvet TTA Drill Guide

JOR1072C \$216.00/ea



Jorvet 1.9mm Pins for TTA

JOR1072D (set of 2) \$33.00/pr



Jorvet TTA Fork Holder

JOR1072E \$170.00/ea



Jorvet TTA Spreader w/ 6,9 & 12mm Inserts

JOR1072F \$316.00/ea

TTA Stainless Steel Instrument Kit

JOR1072K \$1,390.00/ea



Jorvet TTA Cage

| | | |
|------------|-------------------------|-------------|
| JOR1072JA | 6 X 16 Stainless Steel | \$76.00/ea |
| JOR1072JAT | 6 X 16 Titanium | \$95.00/ea |
| JOR1072JB | 6 X 19 Stainless Steel | \$76.00/ea |
| JOR1072JBT | 6 X 19 Titanium | \$95.00/ea |
| JOR1072JC | 6 X 22 Stainless Steel | \$76.00/ea |
| JOR1072JCT | 6 X 22 Titanium | \$95.00/ea |
| JOR1072KA | 9 X 19 Stainless Steel | \$95.00/ea |
| JOR1072KAT | 9 X 19 Titanium | \$106.00/ea |
| JOR1072KB | 9 X 22 Stainless Steel | \$95.00/ea |
| JOR1072KBT | 9 X 22 Titanium | \$106.00/ea |
| JOR1072KC | 9 X 25 Stainless Steel | \$95.00/ea |
| JOR1072KCT | 9 X 25 Titanium | \$106.00/ea |
| JOR1072MA | 12 X 22 Stainless Steel | \$106.00/ea |
| JOR1072MAT | 12 X 22 Titanium | \$115.00/ea |
| JOR1072MB | 12 X 25 Stainless Steel | \$106.00/ea |
| JOR1072MBT | 12 X 25 Titanium | \$112.00/ea |
| JOR1072MC | 12 X 28 Stainless Steel | \$106.00/ea |
| JOR1072MCT | 12 X 28 Titanium | \$115.00/ea |



Box & Silicone Insert for TTA Equipment

JOR1072BS \$290.00/ea

Stainless Steel Case for TTA Equipemnt

JOR1072Q \$140.00/ea

Silicone Insert for JOR1072Q

JOR1072R \$72.00/ea



TTA Screw Box

JOR1072SB \$200.00/ea

TTA System Pilot Drill - 2.4 System

JOR372CH 2.5mm drill bit hard \$39.00/ea

JOR372CP 1.8mm pilot for 2.4 system \$37.00/ea



Cruciate Repair Kit TTA

JOR1072 2.4 clear drill for 2.4 system \$3,720.00/ea



TTA Cruciate Repair Kit

JOR1072T \$4,750.00/ea

TTA Instrument Kit-Titanium

JOR1072TK \$1,500.00/ea



TTA 2.4 Cross Head Screw Driver

JOR412CH \$148.00/ea

Fork 3 prong Titanium

JOR1072PAT \$39.00/ea

Fork 3 Prong

JOR1072PA \$39.00/ea

Fork 4-Prong

JOR1072PB \$39.00/ea

Fork 4-Prong Titanium

JOR1072PBT \$39.00/ea

Fork 5-Prong Titanium

JOR1072PCT \$52.50/ea

Fork 5-Prong

JOR1072PC \$39.00/ea

Fork 6-Prong

JOR1072PD \$52.50/ea

Fork 6-Prong Titanium

JOR1072PDT \$52.50/ea

Fork 7-Prong

JOR1072PE \$52.50/ea

Fork 7-Prong Titanium

JOR1072PET \$52.50/ea

Fork 8-Prong

JOR1072PF \$52.50/ea



We do not stock all Orthopedic Products. Note that Jorvet/Jorgensen brand Products have a \$10 Dropship fee, as well as extra overnight fees.

Orthopedic Products

Orthopedic Drills & Accessories



Makita Orthopedic Power Drill Set

A power driver with features making it the best on the market. The power source is a high quality cordless reversible Makita driver drill.

- Variable-speed 0-600 RPM vs. Standard model which has 100 or 200 RPM settings.
- No skating effect at start, when drill may skid or jump
- 31/2" cannulated extension with 1/4" Jacobs chuck
- Extension and chuck can be autoclaved separately. The drill can be covered with an autoclaved shroud (order separately).

JOR238 81/4"L. 2.2 lbs. \$330.00/ea

Makita Orthopedic Drill

Variable-speed 0-600 RPM vs. Standard model which has 100 or 200 RPM settings. Do not autoclave.

JOR238PD Drill Only \$180.00/ea

Jorvet Drill Shroud

Autoclavable Drill Shroud with Velcro closure.

JOR238S \$13.35/ea/ea

Disposable Drill Shroud fits any size drill. Special material has impervious inner layer. Provides full fluid repellency; top side has adhesive strip.

Not Pictured

JOR238SD Disposable, Sterile. 5/pk. \$11.10/pk

Jorvet Small Jacobs Chuck

Lightweight blue anodized aluminum. 120g. 14cm.

- Much finer, more delicate, and less than half the weight of standard chucks
- Ideal for small dogs and cats when using "K" wires and small pins up to 5/32". Handle not slotted as JOR214L

JOR214 120g. 14cm \$188.00/dz

Ortho Chuck Extension Only

JOR238D1 Extension Only \$60.00/ea

Jorvet Jacobs Pin Chuck

Unique design on the standard instrument for introducing bone pins. An open slot cut into the handle permits visibility of the pin resting in the chuck, saving time by allowing the surgeon to check pin depth without having to remove the chuck. The stainless steel Jacob's accepts K-wires as small as 0.035" and pins as large as 1/4". The handle and extension piece are lightweight, blue anodized aluminum alloy. Key and extension piece included.

JOR214L Jacobs Chuck, 10 1/2"L. \$189.00/ea

JOR214LD1 Short chuck & key \$112.00/ea

Power Drill Adapter, With Chuck

JOR238D1 \$164.00/ea



Jorvet Orthopedic Punched Hole Gauge

For pre-drilling positive profile pins. Pre-drill with a bit slightly smaller than the pin shank.

JOR372M \$36.00/ea

Bone Screw and Drill Bit Gauge

Bone Screw and Drill Bit Gauge. (Metric)



JOR372P (Metric) \$27.00/ea

We do not stock all Orthopedic Products. Note that Jorvet/Jorgensen brand Products have a \$10 Dropship fee, as well as extra overnight fees.



Aesculap Pneumatic System for TPLO

Designed to ensure accurate positioning of drill holes prior to inserting screws or prostheses. The pointed end is placed at the desired destination for the drill bit. The body of the device is tightened at the point of entry. Device includes 3 drill sleeves: 3.5mm, 2.5mm, and 2.0mm.

JOR238TP Blade not included \$3,390.00/ea

Jorvet-Aesculap Saw Blades

Lightweight with less vibration. Provides high visibility of osteotomy site.

| | | |
|------------|-------------|-------------|
| JOR238SB24 | Radius 24mm | \$445.00/ea |
| JOR238SB30 | Radius 30mm | \$445.00/ea |



Cast Cutters and Cruciate Repair



Cast Cutter & Accessories **JorVet**

Designed with multiple attachments that allow for a wide range of orthopedic procedures, as well as cast removal. The oscillating head permits delicate work or more aggressive cutting as needed.

Suggested procedures:

- Femoral head excision
- Triple Pelvic Osteotomy TPO
- Amputations
- Trochlear wedge osteotomy
- Necropsy
- Cast removal
- Tibial wedge osteotomy
- Saw specifications:
- Oscillations: 14,500/min.
- 9.6V, includes 110V charger and battery



JOR866Y



JOR866B



JOR866S



JOR866C



JOR866E



Cast Cutter Blades

| | | |
|----------|-------------------------------|-------------|
| JOR866 | Power Saw w/ 2 Blades | \$478.00/ea |
| JOR866A | Cast Cutter Blade | \$95.00/ea |
| JOR866B | Sagittal Blade 12 x 7 x 1.2mm | \$91.00/ea |
| JOR866C | Sagittal Blade 9 x 12 x 45mm | \$91.00/ea |
| JOR866D1 | Battery for power saw | \$238.00/ea |
| JOR866D2 | 110V charger for saw | \$147.00/ea |
| JOR866E | Extension piece for blade | \$193.00/ea |
| JOR866K | Complete kit | \$772.00/ea |
| JOR866S | Cloth Shroud | \$32.50/ea |

| | | |
|---------|---------------------------------|------------|
| JOR866F | Saw blades 0.8mm thick 19.5mm w | \$94.00/ea |
| JOR866G | Saw blades 0.8mm thick 9mm w | \$92.00/ea |
| JOR866V | Power saw w/2 blades 220 volt | \$525.00 |

Stryker Saw adaptor - use w/multi blades

JOR866Y \$212.00/ea

Engel Cast Cutter

Engel Cast Cutter. Stainless steel blade. 5 3/4".

JOR94 Stainless steel blade., 5 3/4" \$13.50/ea



Beeson Cast Spreader

Beeson Cast Spreader. Stainless steel. 12".

JOR94H Stainless steel. 12" \$30.00/ea

Cruciate Repair Crimping Forceps

Designed with a flattened area on the forcep jaws that crimps the metal tubes evenly without risk of cutting the nylon suture.

JOR710 7 1/2" L. \$165.00/ea

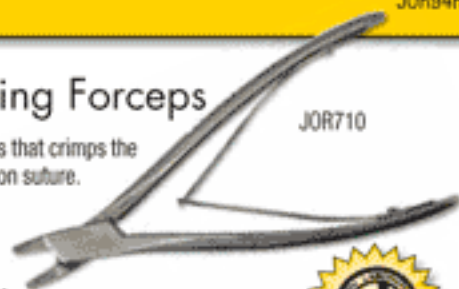

JOR710



Correct - three evenly spaced crimps.

JOR710A-B

Incorrect - not enough crimps.

Incorrect - crimps too close to the end of the tube.



JOR710X

JOR710y

JOR710z

Crimp Tube and Nylon "Ade" Leader Line Configurations

Jorvet Crimp Tube only. Non-sterile.

JOR710B 10mm Crimp Tube Only, For 50 lb. nylon leader line \$6.30/ea

Jorvet Crimp Tube with Nylon Line

JOR710D 10mm Crimp Tube, Plus 500mm 50 lb., (0.7mm) nylon leader line. Tube and Nylon \$15.75/ea

JOR710CG 12mm Crimp Tube, Plus 800mm 100 lb., (1.0mm) nylon leader line. Tube and Nylon \$15.45/ea

JOR710C 12mm Crimp Tube, Plus 800mm 80 lb., (0.9mm) nylon leader line. Tube and Nylon \$15.75/ea

Nylon Line Only **JorVet**

JOR710F 500mm 50 lb. Nylon Leader Line Only. \$6.75/ea

JOR710G 800mm 100 lb. Nylon Leader Line Only. \$6.60/ea

JOR710E 800mm 80 lb. Nylon Leader Line Only. \$6.60/ea

Bulk Nylon Line Only, Non-Sterile.

JOR710EB 80 lb. Nylon Leader Line. 50 yds. Reel, Bulk Nylon Line Only, Non-Sterile \$21.00/ea

JOR710GB 100 lb. Nylon Leader Line. 50 yds. reel, Non-Sterile \$24.00/ea

JOR710FB 50 lb. Nylon Leader Line. 50 yd. Reel, Bulk Nylon Line Only, Non-Sterile \$19.50/ea

Cruciate Needle **JorVet**

Swaged onto nylon suture. Includes crimp tube. Sterile

JOR710K 15mm X-Small Cruciate Needle. Swaged onto 50 lb. nylon leader line with 10mm crimp tube. 500mm L \$13.50/ea

JOR710M 20mm Small Cruciate Needle. Swaged onto 80 lb. nylon leader line with 12mm crimp tube. 800mm L \$13.50/ea

JOR710P 25mm Medium Cruciate Needle. Swaged onto 100 lb. nylon leader line with 12mm crimp tube. 800mm L \$13.50/ea

We do not stock all Orthopedic Products. Note that Jorvet/Jorgensen brand Products have a \$10 Dropship fee, as well as extra overnight fees.



Bone Pin Counter Punch

Useful for tapping in exposed cut ends of small bone pins. Knurled handle. Stainless steel. 135mm length.

JOR215 \$52.00/ea



Hex Screw-Driver

Screwdrivers with screwholding sleeves hold the screw until it has engaged in the threaded hole. The sleeve slides back up the shaft to release the screw without disengaging it.

| | | |
|---------|----------------------------------|-------------|
| JOR412C | for 4.5mm/6.5 mm screws | \$108.00/ea |
| JOR412A | for 2.0mm screws, w/sleeve | \$112.00/ea |
| JOR412B | for 2.7/3.5/4.0 screws, w/sleeve | \$112.00/ea |

Sleeves

| | | |
|----------|------------------------------|------------|
| JOR412AS | Sleeve for JOR412A, w/sleeve | \$93.00/ea |
| JOR412BS | Sleeve for JOR412B | \$90.00/ea |
| JOR412CS | Sleeve for JOR412C | \$90.00/ea |



Depth Gauge

Accurate measurement of hole depth is essential to select the appropriate screw size. A range of gauges is available for the various screw sizes. Hole depth is read from the instrument. Remember to add plate thickness if necessary.

| | | |
|---------|-------------------------------------|-------------|
| JOR410 | for 2.7-4.0mm screws. Range 6-40mm. | \$200.00/ea |
| JOR410A | for 2.0mm screws. Range 6-20mm. | \$202.00/ea |

Fixation Pins Positive Threaded Portion at End of Pin

Positive or raised thread pins have threads extending above the smooth shaft on a portion of the pin. The positive threaded pins have a tougher pull-out resistance and are the external fixation pins used almost exclusively in human orthopedics. There are two choices of pin styles and three different sizes.

1. Threaded portion is in mid-shaft
2. Threaded portion is at the end of the pin

All pins are 316LVM implant quality stainless steel.

| | | |
|---------|--|------------|
| JOR371F | Small. Shaft 3/32" dia., Thread 1/8" dia., Thread Pitch 1" L, Total 4" L, Thread Pitch 0.9mm | \$13.50/ea |
| JOR371G | Medium. Shaft 1/8" dia., Thread 5/32" dia., Thread Part 1 1/4" L, Total 4 1/2" L, Thread Pitch 0.9mm | \$13.50/ea |
| JOR371H | Large. Shaft 5/32" dia., Thread 3/16" dia., Thread Port 1 1/2" L, Total 6" L, Thread Pitch 0.9mm | \$15.10/ea |



Jorvet Goniometer Plastic 360

The goniometer can be used for the calculation of tibial plateau angles, wedge resections, angles of anteversion plus others. It also can be used to measure pre- and post-op range of motion to evaluate post-op physiotherapy. White background assures ease of seeing number on any color dog.

JOR752P Medium for dogs over 60lbs. 6" (15 cm). \$18.00/ea

Jorvet Goniometer

Canine Rehab Goniometer 5m

| | | |
|---------|----------------------------|------------|
| JOR752M | Small for dogs under 16lbs | \$20.00/ea |
| JOR752 | Large | \$99.00/ea |



Adjustable Drill Guide Jorvet

Designed to ensure accurate positioning of drill holes prior to inserting screws or prostheses. The pointed end is placed at the desired destination for the drill bit. The body of the device is tightened at the point of entry. Device includes 3 drill sleeves: 3.5mm, 2.5mm, and 2.0mm.

| | | |
|----------|---|-------------|
| JOR414H | 3.5mm, 2.5mm and 2.0mm sleeves. | \$260.00/ea |
| JOR414HL | 4.5mm sleeve. | \$191.00/ea |
| JOR414HX | for use with JOR414HL 5.5mm sleeve (equine) 13cm length spread. | \$68.00/ea |



Load/Neutral Drill Guide

To exert compression at a fracture site, the pilot bit must be positioned precisely in the slot in the compression plate. The load/neutral drill guide has two sleeves, one for compression (load) and one where no compression is exerted (neutral). There is one combined guide for each screw size.

| | | |
|---------|--|-------------|
| JOR411 | for 2.4mm plate and 1.8mm pilot hole bit. | \$270.00/ea |
| JOR411B | for 2.7mm plates. Uses 2.0mm pilot hole drill bit. | \$336.00/ea |
| JOR411C | for 3.5mm plates. Uses 2.5mm pilot hole drill bit. | \$330.00/ea |
| JOR411D | for 4.5mm plates. Uses 3.2mm pilot hole drill bit | \$330.00/ea |

We do not stock all Orthopedic Products. Note that Jorvet/Jorgensen brand Products have a \$10 Dropship fee, as well as extra overnight fees.

13822 WEST BOULTON BLVD. METTAWA, IL 60045

WWW.SHOPMEDVET.COM

Phone 800-544-7521

260

Fax 800-204-2177



Jorvet CCL Lateral Suture System Double Swaged-On Line and Needle.

Some CCL deficient patients benefit from the use of double sutures. This is particularly true of very large dogs and 100 lb line. Passing a second needle behind the fabella risks damaging the first line and the peri-fabellar structures which ultimately will hold the nylon sutures. Double line, Swaged-on sutures allow the placement of two lines with one pass of the needle. Available as single sterile packs with or without crimps. The double line is supplied Swaged on as a loop and will, therefore, be of interest to those surgeons using the self-locking McKee/Miller knot (VCOI 1999/12:78-80)

Jorvet Double Line and Needle

| Without crimp tube | | | |
|--------------------|---|--|-----------|
| JOR710KD | 500mm x 2 Line. 50 lb. / X-Small Needle | | \$9.00/ea |
| JOR710MD | 800mm x 2 Line. 80 lb./Small Needle | | \$9.00/ea |
| JOR710PD | 800mm x 2 Line. 100 lb./Medium Needle | | \$8.10/ea |

Jorvet Double Line, Needle and Crimps

| | | |
|----------|--|------------|
| JOR710KE | 500mm x 2 Line. 50 lb. / X-Small Needle, Plus 10mm Crimps. | \$19.50/ea |
| JOR710PE | 800mm x 2 Line. 100 lb. / Medium Needle, Plus 12mm Crimps. | \$19.50/ea |
| JOR710ME | 800mm x 2 Line. 80 lb. / Small Needle, Plus 12mm Crimps. | \$20.25/ea |

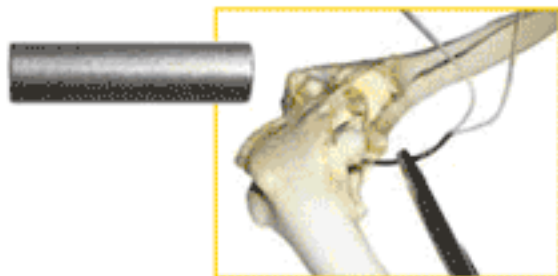

Jorvet Mason Nylon Line

Mason nylon line 100yd spools.

| | | |
|---------|---------------|------------|
| JOR714 | 20lb, 100 yds | \$28.50/ea |
| JOR714A | 40lb | \$42.00/ea |
| JOR714B | 60lb | \$63.00/ea |
| JOR714C | 80lb | \$75.00/ea |
| JOR714D | 100lb | \$88.00/ea |



Jorvet Cruciate Suture Needle

Cruciate Suture Needle. Designed for use with heavy nylon in the lateral suture repair method for cranial cruciate ruptures. Needles are specially curved along with a heavier body, making passage around the femur/fabella area much easier. Stainless steel.

| | | |
|----------|-------------|-------------|
| JOR710XA | Small, 6/pk | \$264.00/ea |
|----------|-------------|-------------|

Jorvet Cruciate Suture Needle

Cruciate Suture Needle. Designed for use with heavy nylon in the lateral suture repair method for cranial cruciate ruptures. Needles are specially curved along with a heavier body, making passage around the femur/fabella area much easier. Stainless steel.

| | | |
|----------|--------------------------|-------------|
| JOR710W | X-Small, 15mm dia. 6/pk. | \$8.10/pk |
| JOR710XA | Small, 6/pk | \$264.00/ea |
| JOR710Y | Medium, 6/pk | \$8.70/pk |
| JOR710Z | Large, 6/pk | \$8.70/pk |



Jorvet Meniscus Probe

Visualization of the caudal horns of the meniscus can be a challenge. Often the process of exposing the caudal horn can result in distortions. A normal meniscus can look damaged or a "bucket handle" tear can sit back and look normal. It is helpful to gently probe the meniscus to establish its true condition. Dimensions refer to length of tip. Use 1mm in dogs <30kg and for dogs >30kg use a 2mm.

| | | |
|----------|------------------------|------------|
| JOR710N | 2mm (nerve hook) Probe | \$23.50/ea |
| JOR710NA | 1mm Probe | \$21.00/ea |



Mason Line Crimp Tubes

These crimp tubes are specifically designed to be compatible with Mason brand of nylon line also used in the Securos® brand crimp tube range. All stainless implants grade with polished seamless tubing. Mason line swaged on various special sterile cruciate needles.

| | | |
|----------|----------------------|---------------|
| JOR1070 | 40# crimp tube 15pk | \$60.00/ea/pk |
| JOR1070A | 80# crimp tube 15pk | \$60.00/pk |
| JOR1070B | 100# crimp tube 15pk | \$60.00/pk |

Mason line swaged on various special sterile cruciate needles.

| | | |
|-----------|--|------------|
| JOR1070KA | 40lb nylon with medium cruciate needle | \$57.00/pk |
| JOR1070KB | 40lb double nylon line with medium cruciate needle | \$57.00/pk |
| JOR1070KC | 40lb double nylon line with small cruciate needle | \$57.00/pk |
| JOR1070M | 80lb nylon with large cruciate needle | \$57.00/pk |
| JOR1070MB | 80lb nylon with small cruciate needle | \$57.00/pk |
| JOR1070MD | 80lb double nylon line with medium needle | \$57.00/pk |
| JOR1070ME | 80lb double nylon line with large needle | \$57.00/pk |
| JOR1070MF | 80lb double nylon line with small needle | \$57.00/pk |

We do not stock all Orthopedic Products. Note that Jorvet/Jorgensen brand Products have a \$10 Dropship fee, as well as extra overnight fees.

13822 WEST BOULTON BLVD. METTAWA, IL 60045

WWW.SHOPMEDVET.COM

Phone 800-544-7521

261

Fax 800-204-2177



Jorvet CCL Suture System Starter Kit

- JOR710SA • Crimping forceps \$240.00/ea
 • 2 pkg. of each (3) different sized cruciate needles swaged onto nylon line and crimp tubes. Sterile. (6 total) (implants for 6 procedures)
 • Procedure instructions on CD-ROM
- JOR710S Cruciate Repair Starter Kit \$395.00/ea



Jorvet Tensioning Clamp

These small stainless steel clamps feature knurled knobs that lock onto the nylon suture. After that, they are attached to a standard Gelpi or Weillaner retractor and tension applied to the proper level. No need to throw away crimp tubes or purchase expensive tensioning instruments.

- JOR710R Pair \$54.00/pr



Heavy-Duty Needle Driver

Tungsten carbide jaws. Especially designed to grip cruciate needle and ease passage around tough fabella tissue. 7"L.

- JOR710Q 7"L \$68.00/ea

Cruciate Repair CD/Rom

Complete procedure available at nominal cost.

- JOR710V FREE with CCL Suture System Starter Kit

Compound Action Crimper

- JOR710X 7 1/2" \$8.70/pk



Jorvet LigaFiba Braided Polyethylene Fiber (Material Only)

Monofilament nylon has been the standard suture material for the lateral suture technique for repair of CCL damage. Newer materials are made of braided polyethylene fiber and offer several advantages over nylon.

- Significantly stronger (up to 15 times)
- Better flex fatigue resistance and abrasion
- Knots tie easier This makes LigaFiba suture material an ideal material for ligament and tendon repair. Its available packages are:
- LigaFiba suture material only
- Provided with attached cruciate needle and straight needle
- LigaFiba with toggle buttons in bone tunnel procedures in both cruciate and hip repairs



| | | |
|---------|-----------------------------|------------|
| JOR444A | 150 lb test X 500mm length | \$15.00/ea |
| JOR444B | 250lb. Test x 600mm sterile | \$17.50/ea |
| JOR444C | 500 lb test X 600mm length | \$20.00/ea |

Jorvet LigaFiba Lateral Suture

LigaFiba lateral suture with swaged on needles one end has attached cruciate needle for fabella ligament passage. The other end a straight needle for passing through tibial crest. The LigaFiba ties easily but also can be crimped (require JorVet fiber crimper instrument JOR710x) and JorVet fiber crimp JOR448a. Sterile package.

- JOR444D 20lb w/needles \$31.50/ea
 JOR444E 500lb w/needles \$31.50/ea



Jorvet LigaFiba ISO Toggle Suture

A newer technique for extra capsular repair of CCL damage uses a bone tunnel between iso metric point on the femur. A set of small toggles are used instead of passage through the fabella ligament. The LigaFiba is passed through the bone tunnel with an attached straight needle. Step by step guidelines available The LigaFiba can be readily tied by the toggle button. Step by step guidelines available. The LigaFiba can be readily tied by the toggle button

- JOR444F 250 lb test (dogs up to 50lbs) Bone tunnel use JOR372cx, 2.5mm drill \$88.00/ea



Graft Passer with Small Eye



Instrument with handle and thin 3cm radius curved tip with small eye. The small eye will hold the large nylon suture used in cruciate repair. The curved end is used to access tight areas (i.e., between the fabella and femoral condyle).

- JOR236SE 6"L., Stainless Steel \$95.00/ea

Bone Tunnel Borer



The borer is a small handle with an attached drill bit. This hand instrument is used to create a bone tunnel quickly and easily without having to set up a complete orthopedic drill (i.e., CCL repair through tibial tuberosity). Stainless steel. 18cm.

- JOR236T 2.7mm \$81.00/ea
 JOR236TC w/Counter Sink \$102.00/ea

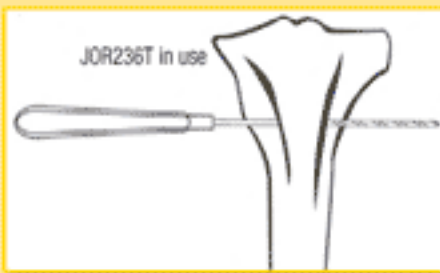

JOR236T

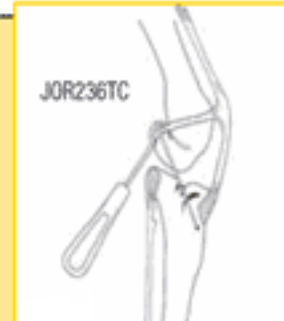

JOR236TC

We do not stock all Orthopedic Products. Note that Jorvet/Jorgensen brand Products have a \$10 Dropship fee, as well as extra overnight fees.

13822 WEST BOULTON BLVD. METTAWA, IL 60045

WWW.SHOPMEDVET.COM

Phone 800-544-7521

262

Fax 800-204-2177

Hohman Retractors, Graft Passer & Meniscus Clamp



Hohman Retractor

Jorvet

JOR235A

Greatly improve exposure and access in the small surgical field of joint surgery. Stainless steel.

| | | |
|---------|--|------------|
| JOR235A | 12mm W x 24cm L (9"). Medium breeds | \$67.00/ea |
| JOR235B | 18mm W x 24cm L (9 1/2"). Large breeds | \$61.00/ea |
| JOR235C | 8mm | \$61.00/ea |



Mini Hohman Retractor

Jorvet

Greatly improve exposure and access in the small surgical field of joint surgery. Stainless steel.

| | | |
|---------|------------|------------|
| JOR235M | 6mm x 16cm | \$45.00/ea |
|---------|------------|------------|

JOR235M

Super Mini 4mm Hohman Retractor

| | | |
|----------|-----|------------|
| JOR235MA | 4mm | \$62.00/ea |
|----------|-----|------------|

Stainless Steel Spike Washer

Used for ligament attachment or fixation to spread load or retain wire or sutures. Autoclavable.

| | | |
|----------|--------------------------|------------|
| JOR375WC | for use with 2.7mm screw | \$9.60/ea |
| JOR375WD | for use with 3.5mm screw | \$14.40/ea |
| JOR375WE | for use with 4.5mm screw | \$11.25/ea |



Duck-Billed Mini-Rongeur

This X-small rongeur was designed specifically for use in delicate spinal cord surgery. It is especially effective in removing the final layer of bone overlying the spinal cord in laminectomy procedures. Stainless Steel.

| | | |
|--------|------------------|-------------|
| JOR224 | 2mm bite, 5 1/4" | \$164.00/ea |
|--------|------------------|-------------|



Ecklin-Duckbill Rongeur

Double action. 3mm bite, 8 1/2".

| | | |
|---------|----------------------------------|-------------|
| JOR225E | Double action, 3mm bite, 8 1/2". | \$190.00/ea |
|---------|----------------------------------|-------------|



Jorvet Stifle Lever

Jorvet

Examination and management of meniscal injuries is made extremely difficult by the limited access to the medial meniscus during routine approaches. Exposure of the medial meniscus is typically achieved by either use of a stifle distractor or by a Hohman retractor. Hohman retractors are not designed for levering against articular cartilage in that the blade does not "fit" the trochlea. The stifle lever is designed to substitute the Hohman. The caudal surface of the stifle lever is contoured to fit the trochlea of large dogs. The load is dissipated over a large area minimizing trauma. The ring style handle is convenient for retraction by the surgeon using the thumb. The tip atraumatically hooks behind the caudal aspect of the tibial plateau.

| | | |
|---------|--------------------|------------|
| JOR235S | 9" (225mm) length. | \$61.00/ea |
|---------|--------------------|------------|

Jorvet Curved Graft Passer

Used in anterior cruciate repairs such as the "over the top procedure." Using the Graft Passer lessens the risk of damage to joint surfaces and ancillary structures. Stainless steel.

| | | |
|----------|---------------------------|-------------|
| JOR236XS | X-Small, 2.0cm dia. head. | \$106.00/ea |
|----------|---------------------------|-------------|



Jorvet Graft Passer with Small Eye

Instrument with handle and thin 3cm radius curved tip with small eye. The small eye will hold the large nylon suture used in cruciate repair. The curved end is used to access tight areas (i.e., between the fabella and femoral condyle).

| | | |
|----------|-----------------------|------------|
| JOR236SE | 6"L., Stainless Steel | \$95.00/ea |
|----------|-----------------------|------------|



Micro Tooth Meniscus Clamp

Management of meniscal injuries is very important. In medium and small dogs space limits access. The toothed minimeniscus forceps are designed to grasp damaged meniscus tissue to facilitate removal using micro blades.

| | | |
|---------|--|------------|
| JOR236H | The toothed minimeniscus forceps are designed to grasp damaged meniscus tissue to facilitate removal using micro blades. | \$36.00/ea |
|---------|--|------------|



Jorvet Meniscus Knife

A specially-designed knife for use in the limited space of the canine stifle.

| | | |
|---------|------|-------------|
| JOR236M | 15cm | \$102.00/ea |
|---------|------|-------------|

JOR236M



Double Loop Cerclage Wire Tightener

Cerclage wire tightener with two tightening knobs for double loop eyed wire. Fiber handle

1. Use single tightener for single wire
2. Use both tighteners for double loops

| | |
|----------|-------------|
| JOR218LD | \$140.00/ea |
|----------|-------------|



Jorvet Stifle Lever

Jorvet

Examination and management of meniscal injuries is made extremely difficult by the limited access to the medial meniscus during routine approaches. Exposure of the medial meniscus is typically achieved by either use of a stifle distractor or by a Hohman retractor. Hohman retractors are not designed for levering against articular cartilage in that the blade does not "fit" the trochlea. The stifle lever is designed to substitute the Hohman. The caudal surface of the stifle lever is contoured to fit the trochlea of large dogs. The load is dissipated over a large area minimizing trauma. The ring style handle is convenient for retraction by the surgeon using the thumb. The tip atraumatically hooks behind the caudal aspect of the tibial plateau.

| | | |
|---------|--------------------|------------|
| JOR235S | 9" (225mm) length. | \$61.00/ea |
|---------|--------------------|------------|

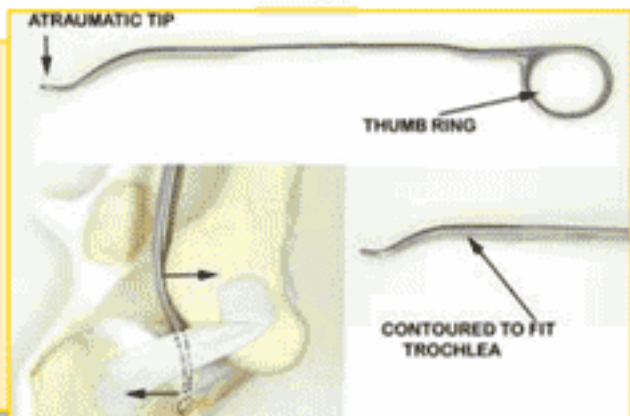

We do not stock all Orthopedic Products. Note that Jorvet/Jorgensen brand Products have a \$10 Dropship fee, as well as extra overnight fees.

13822 WEST BOULTON BLVD. METTAWA, IL 60045

WWW.SHOPMEDVET.COM

Phone 800-544-7521

263

Fax 800-204-2177

Orthopedic Products

Miscellaneous



Bone Wax **JorVet**

This natural wax will control the seepage of blood from cut/cancellous bone, which obscures the visual field. The wax acts as a physical barrier.



JOR9120 This natural wax will control the seepage of blood from cut/cancellous bone, which obscures the visual field. The wax acts as a physical barrier. \$113.00/lb

Autoclavable Cases **JorVet**

Designed to ensure accurate positioning of drill holes prior to inserting screws or prostheses. The pointed end is placed at the desired destination for the drill bit. The body of the device is tightened at the point of entry. Device includes 3 drill sleeves: 3.5mm, 2.5mm, and 2.0mm.

JOR429C 3.5mm, 2.5mm, and 2.0mm \$325.00/ea

Bone Screw Rack Only

JOR429D2 Rack for JOR429 \$110.00/ea

Bone Screw Rack for JOR430D

JOR430D2M for JOR430D \$120.00/ea

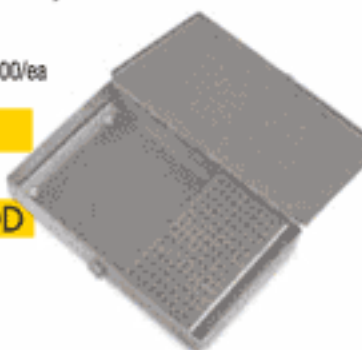

Jorvet Cerclage Wire Passer

This is a simple instrument for passage of cerclage wire around fracture sites. Stainless steel. 15cm.

- Minimizes trauma to surrounding tissue
- Saves surgical time
- Double-ended for a whole range of bone sizes

JOR217 \$42.00/ea

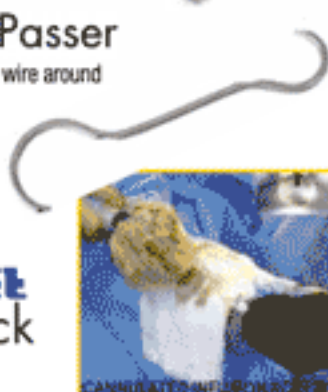

JorVet Cannulated Luer Lock

JOR343 16mm \$145.00/ea

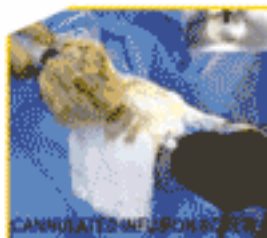

Plate 3-Hole SS

JOR1072NA \$39.00/ea

Plate 3-Hole Titanium

JOR1072NAT \$45.00/ea

Plate 4-Hole SS

JOR1072NB \$39.00/ea

Plate 4-Hole Titanium

JOR1072NBT \$45.00/ea

Plate 5-Hole SS

JOR1072NC \$39.00/ea

Plate 5-Hole Titanium

JOR1072NCT \$45.00/ea

Plate 6-Hole SS

JOR1072ND \$51.00/ea

Plate 6-Hole Titanium

JOR1072NDT \$60.00/ea

Plate 7-Hole SS

JOR1072NE \$52.50/ea

Plate 7-Hole Titanium

JOR1072NET \$60.00/ea

Plate 8-Hole SS

JOR1072NF \$52.50/ea

Plate 8-Hole Titanium

JOR1072NFT \$60.00/ea

Bone Washer

JOR375F-JOR375H

Plain bone washers. Stainless steel.

JOR375F Plain Washer 1.5/2.0/2.2mm screw \$5.95/ea

JOR375G Plain Washer 2.7mm/3.5mm/4.0mm screw \$5.95/ea

JOR375H Plain Washer 4.5mm screw \$8.65/ea



Stainless Steel case w/Screw Rack

Stainless Steel Case with screw rack.

JOR429CS \$325.00/ea

Jorvet Stifle Retractor

The examination of the meniscus and intraarticular structure during anterior cruciate repair is a real necessity. This visualization often is difficult even in the largest of dogs. The stifle retractor allows gentle retraction between the femur and tibia, exposing the entire stifle joint to a thorough exam without damaging the joint surface. Stainless steel.

JOR240W \$210.00/ea

JOR240WB (<50 Kg), X-Small \$158.00/ea

JOR240WS Wallace \$135.00/ea



Modified Stifle Retractor

Designed for medium and large dogs (the group with the highest incidence of meniscal damage), this improved model has longer jaw tips which are self protecting when the instrument is in the closed position. Once inserted atraumatically into the stifle, distraction exposes the longer tips for maximum grip. The best instrument to examine the caudal horn of the medial meniscus.

JOR240WM (15-50 Kg), 7 1/2" \$213.00/ea

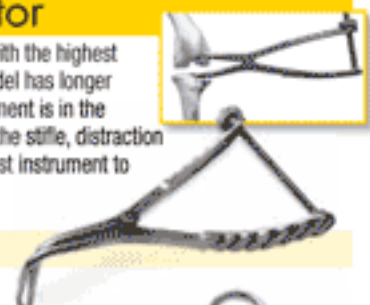

Jorvet Small Stifle Retractor

5", 6mm profile. The small overlapping tips allow atraumatic entry into small arthrotomies and small stifles.

JOR240WA (5-50 Kg) \$161.00/ea



Stifle Distractor w/Spinlock

The working tips of our spinlock are the same as the ratchet version. The spinlock offers more secure distraction as it is less likely to slip. The spinlock also offers an infinite range of position versus the ratchet.

JOR240WAS Small \$180.00/ea

JOR240WBS X-Small \$180.00/ea



We do not stock all Orthopedic Products. Note that Jorvet/Jorgensen brand Products have a \$10 Dropship fee, as well as extra overnight fees.

13822 WEST BOULTON BLVD. METTAWA, IL 60045

WWW.SHOPMEDVET.COM

Phone 800-544-7521

264

Fax 800-204-2177



Jorvet Small Fragment Forceps

Single pointed reduction forceps typically applies pressure at the exact point where it is desirable to place an implant. Splitting the tips allows implants to be placed at the ideal position (e.g., repair of lateral condyle fractures).

JOR212S 5 1/4" \$122.00/ea

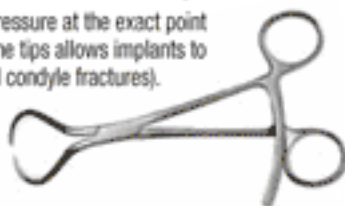

JOR212L Extra Large, 8". May be used to provide temporary stabilization of osteotomy while the plate is contoured and placed. \$128.00/ea

JOR212LS Large, Spin Lock Closure. 7 1/2" \$163.00/ea

JOR212M Medium, 135mm. \$119.00/ea



Esophageal Foreign Body Forceps

- One day you will need these!! An especially long forceps that can remove foreign bodies such as fish hooks or lodged bones from even the distal esophagus or trachea.
- Backward facing teeth for maximum grip
- shaft diameter small as possible to allow placement of endoscope alongside

JOR212EFB 25cm shaft x 3.0mm diameter \$160.00/ea



Twin-Point Fragment Forceps

Single pointed reduction forceps typically apply pressure at the exact point where it is desirable to place an implant. Splitting the tips allows implants to be placed at the ideal position (e.g., repair of lateral condyle fractures).

JOR212TC Curved Tip, 6 1/2" \$133.00/ea

JOR212TS Straight Tip, 6 1/2" \$123.00/ea



Bone Plate Holding Forceps

These forceps are designed to maintain plate position through a hole in the plate. The ball, just behind the point of the jaw, locates in bone plate screw hole causing minimal interference elsewhere in the operation site. Also, useful as a reduction forceps in soft young bone, as the balls prevent over-penetration of the bone.

JOR212P 6" (15 cm). \$133.00/ea



Reduction Forceps with Spinlock

Spin lock. Provides incremental secure control, round ends.

JOR212GS Standard, 6" (15cm). \$104.00/ea



Baby Kerns Bone Forceps

German made, Stainless steel. **Jorvet**

JOR159L Standard, 8" (21cm) \$169.00/ea

JOR159 15cm, 6" \$147.00/ea



Mini Baby Kerns Bone Holding Forceps

JOR159M 10cm, 4" \$105.00/ea

Jorvet Verbrugge Forceps

JOR213VA 6.5" \$192.00/ea

JOR213VB 9.5" \$220.00/ea

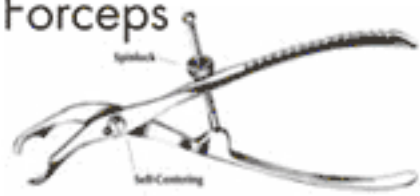

Bone Holding Forceps

- For small dogs and cats
- Wide jaws offer maximum compression
- Bone screws and IM pins can be inserted through the center

JOR213 Stainless steel, 15 cm. 6" \$133.00/ea



Pig OB Forceps

Danish model. These forceps open sideways, making it practically impossible to catch the uterine lining. The piglet is gently grasped either around the head or the hips. No need of inserting your hand to place the instrument.

JOR22 23" L. \$24.00/ea



Condyle Clamp

An improvement over the old style rectangular plexi-glass condyle clamp. This triangular, stainless steel, two-sided clamp fits over the humeral condyles and allows greater alignment. A lag screw can be inserted through the hole in the middle of the triangular plate. Reduction may be checked by radiography prior to lag screw fixation. Pressure should be applied proximo-laterally not just purely laterally.

JOR213C \$106.00/ea



We do not stock all Orthopedic Products. Note that Jorvet/Jorgensen brand Products have a \$10 Dropship fee, as well as extra overnight fees.

13822 WEST BOULTON BLVD. METTAWA, IL 60045

WWW.SHOPMEDVET.COM

Phone 800-544-7521

265

Fax 800-204-2177



Jorvet Bone Plate Benders

Proper contouring of bone plates is a necessity for proper reduction of fractures. Used in pairs, bone plate benders are the most cost-effective method of plate contouring. Stainless steel.

- JOR853 Small Bender. 1.5mm/2.0mm. Used for small 1.5/2.0mm plates. 140mm L. Pr/Pk. \$59.00/pr
- JOR853B Heavy Bender. 4.5mm. Used for 3.5mm broad and 4.5mm plates. 200mm L. Pr/Pk. \$82.00/pr



Jorvet Plate Bending Pliers

Double-sided roller-type. Used for 3.5mm narrow, 3.5mm broad and 4.5mm narrow plates. Stainless steel with aluminum handles.

- JOR852 15" (380mm) L. \$307.00/ea



Jorvet Reconstruction Plate Pliers

Used for 3.5mm reconstruction plates. Stainless steel.

- JOR852A 290mm L. \$212.00/ea



Plate Bending Pliers TPLO Guide Wire Bender

Also useful for bending guide pins for the TPLO technique. Stainless steel with satin finish.



- JOR854X Contours 2.7/3.5mm narrow bone plates \$445.00/ea

Jorvet Bone Scriber

- JOR822T \$32.00/ea



Leighton Bone Pin Introducer

designed to help reduce overriding fractures and facilitate insertion of the intramedullary pin into the distal segment of a fracture.

- JOR158 (see illustration for explanation of use) \$170.00/ea



We do not stock all Orthopedic Products. Note that Jorvet/Jorgensen brand Products have a \$10 Dropship fee, as well as extra overnight fees.

Jorvet Bone Toggle only

The toggle insertion process is commonly difficult due to use of home-made or other commercial devices. Typically problematic is the toggle coming back out of the hole in the acetabulum. The toggle insertion device deposits the toggle reliably and safely into the pelvic canal through the 4.5mm hole in the acetabulum. Pulling back on the LigaFiba while retaining the insertion device in the hole "flips" the toggle, preventing pullout. The LigaFiba line which passes through the hole in the toggle is passed down through the drilled hole in the femoral head and neck. Use of an adjustable drill guide (JOR414h) ensures accurate placement of this hole.

- JOR863T Double-wrapped in sterile pouch with LigaFiba (JOR2001b) and button. \$43.00/ea



Jorvet Toggle Insertion Kit

The hip toggle is a well-proven method of management of coxo-femoral luxations. A tunnel is drilled up through the femoral head and neck, plus through the acetabulum where the round ligament normally attaches. The toggle is placed through the acetabulum. It turns cross ways on the medial side of the pelvis. LigaFiba runs the length of the tunnel, and tension is applied to the toggle, keeping the hip in place.

- JOR863 Includes insertion device and one sterile toggle with 180 lb. LigaFiba (JOR2001b) and button. \$130.00/ea



OMROD Orthopedic Button

- JOR863X \$13.50/ea



Deluxe Bone Toggle Kit

Includes: JOR414H Drill Guide, JOR863 Toggle Insertion Kit with 1 toggle, JOR863T Insertion Toggles (5) with buttons and LigaFiba Line. Sterile. JOR863X Omrod Button.

- JOR863K Includes: JOR414H Drill Guide, JOR863 Toggle Insertion Kit with 1 toggle, JOR863T Insertion Toggles (5) with buttons and LigaFiba Line. Sterile. JOR863X Omrod Button. \$550.00/ea



NEW

Buff's Corkscrew Trocar

Buff's Corkscrew Trocar with metal stylet.

- JOR40C \$18.90/ea





Currettes, Elevators & Rongeurs

Volkman Bone Curette



| | | | |
|------------------|---------|--|------------|
| JORGENSEN | JOR222A | Excellent for OCD lesions. Oval cutting surface. German-made. Stainless steel. 22cm., #000 | \$37.50/ea |
| | JOR222A | Excellent for OCD lesions. Oval cutting surface. German-made. Stainless steel. 22cm., #000 | \$37.50/ea |

NEW

Hatt Spoon Curette



An alternative to the disarticular in large dogs. The edge of the spoon is very sharp. A fiber handle for balance. 230mm (9.4") Oval shaped scoop.

| | | |
|---------|-------------------|------------|
| JOR222N | 17mm x 30mm scoop | \$73.00/ea |
| JOR222P | 12mm x 18mm scoop | \$73.00/ea |
| JOR222Q | 7mm x 12mm scoop | \$73.00/ea |

Jorvet House Curette

| | | |
|---------|--------------------|------------|
| JOR222H | 2.5mm + 3.0mm ends | \$47.00/ea |
|---------|--------------------|------------|



Key Periosteal Elevator

Slightly curved blade.



| | | |
|---------|---|------------|
| JOR226A | German, Stainless Steel, 190mm. (7 1/2"), Blade, 6mm | \$64.00/ea |
| JOR226B | German, Stainless Steel, 190mm. (7 1/2"), Blade, 12mm | \$64.00/ea |
| JOR226C | German, Stainless Steel, 190mm. (7 1/2"), Blade, 19mm | \$64.00/ea |

Jorvet

Freer Elevator

Knurled double-ended elevator with curved fine spatula tips. Useful for lifting of tissue layers.



| | | |
|---------|-------------------------------------|------------|
| JOR2260 | Stainless Steel, German, 7" (18cm). | \$48.50/ea |
|---------|-------------------------------------|------------|

Jorvet

Periosteal Elevator

A popular configuration available in 6mm curved up. Lightweight fiber handle.

| | | |
|---------|---------------------------------|------------|
| JOR226S | 180mm. (7 1/2"), Curved 6mm tip | \$68.00/ea |
| JOR226R | 180mm. (7 1/2"), Square 6mm tip | \$63.50/ea |

Jorvet



Jorvet Ruskin Rongeur

German-made. Stainless steel.

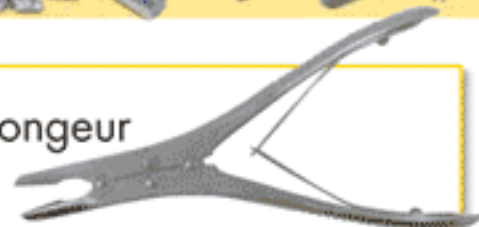

| | | | |
|------------------|---------|--|-------------|
| JORGENSEN | JOR225C | Curved, German, Stainless Steel, 4mm bite, 18cm (7") | \$190.00/ea |
|------------------|---------|--|-------------|

Eqiune Dental Compound Rongeur

Large 6mm bite is used to aggressively remove pieces of tooth. They bite with a strong compound action. Also, useful to remove heavy plaque from teeth. Slightly curved head.

| | | |
|---------|-----------|-------------|
| JOR225X | 9" length | \$110.00/ea |
|---------|-----------|-------------|

Jorvet



Micro Friedman Rongeur Curved

| | | | |
|------------------|---------|---|-------------|
| JORGENSEN | JOR224F | Very delicate. 5 1/2" (14cm) Curved Jaw, 1.3mm W. | \$102.00/ea |
|------------------|---------|---|-------------|



Stille-Luer Rongeur

| | | |
|---------|---------------------------------|-------------|
| JOR225L | Curved, 8mm bite. 22cm (8 1/2") | \$190.00/ea |
|---------|---------------------------------|-------------|

Jorvet



Laminectomy Rongeurs

| | | |
|-----------|------------|-------------|
| JOR225LRA | 2mm x 16cm | \$135.00/ea |
| JOR225LRB | 3mm x 16cm | \$135.00/ea |
| JOR225LRC | 4mm x 16cm | \$135.00/ea |



Liston Bone Cutting Forceps

Single action forceps

| | | | |
|------------------|--------|---------------------------------|-------------|
| JORGENSEN | JOR223 | German, Stainless Steel, 5 1/2" | \$170.00/ea |
|------------------|--------|---------------------------------|-------------|



We do not stock all Orthopedic Products. Note that Jorvet/Jorgensen brand Products have a \$10 Dropship fee, as well as extra overnight fees.

13822 WEST BOULTON BLVD. METTAWA, IL 60045

WWW.SHOPMEDVET.COM

Phone 800-544-7521

267

Fax 800-204-2177

Orthopedic Products

K-Wire & Bone Instruments

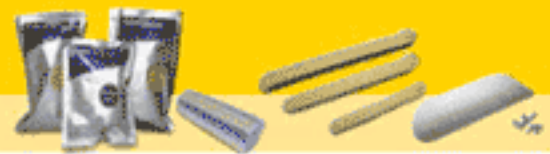

Jorvet Steel Stainless K-wire

K-Wire or Fine Orthopedic Wire. Highest quality stainless steel type 316LVM. U.S.A. made. Double Trocar Point.

| | | |
|---------|-----------------|------------|
| JOR250M | .035" X 7" 6/Pk | \$16.80/pk |
| JOR250N | .045" X 7" 6/Pk | \$16.80/pk |
| JOR250P | .062" X 7" 6/Pk | \$19.50/pk |



Jorvet Steel Stainless K-Wire

Highest quality stainless steel type 316LVM. U.S.A. made. Double Trocar Point.

| | | |
|----------|---------------------------------|-----------|
| JOR250MA | .035 x 7" | \$3.10/ea |
| JOR250PA | .062 x 7", double point, single | \$3.10/ea |
| JOR250NA | Single, .045 x 7" | \$3.00/ea |

Jorvet Small Pin Vise

JOR214K 3 ft" L holds small K-wires and pins up to 2.5mm (3/32") \$78.00/ea



Jorvet K-Wire Cutter

JOR2206B Tungsten Carbide Inserts, \$210.00/ea
Cuts wire up to 2.2mm. 9"L.



Jorvet Smaller K-wire/Small Pin Punch

JOR215A Small. 1.6mm fine tip. \$54.00/ea



Jorvet Small Angles Bone Cutter

Especially useful for small dogs and cats. The jaws have the ideal size and angle for:

- Femoral head and neck excision
- Tibial crest translocation
- Many other small bone cutting procedures

JOR223S 15mm blade. 6 1/2" (170mm) length. \$125.00/ea



Jorvet

Jorvet Bone Chisel

Striking button for easier use with Gerzog mallet. German-made.

| | | |
|---------|--|------------|
| JOR227A | Stainless Steel. 6mm, 17cm L (6 1/2") | \$54.00/ea |
| JOR227B | Stainless Steel, 12mm, 17cm L (6 1/2") | \$54.00/ea |

Jorvet

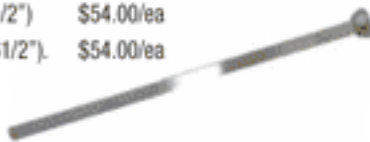

Orthopedic Distractor **Jorvet**

Can be used with ESF Pins 3.2-4.0mm. Distractors are useful instruments for the proper repositioning and compression of long bone fractures. The distractor will hold the bone in anatomical alignment and allow the placement of either bone plates, K-E external fixation devices, or bone screws. The instrument will greatly reduce the amount of manipulation that goes on when trying to maintain alignment during surgery, and allows the surgeons to concentrate their efforts on applying the proper fixation device.

JOR237 \$610.00/ea



Stille Liston Bone Cutting Forceps

33-1668 10.5", Double Action 4mm jaw \$129.00/ea



Gerzog Mallet **Jorvet**

Hollow handle with 16 oz. lead-filled head. 25 x 35mm head. German-made. 18cm (7 1/4"). Stainless steel.

JOR228M 18cm (7 1/4"), German-made, Stainless steel. \$54.00/ea



Jorgensen Osteotome **Jorvet**

JOR228B Stainless Steel. 13.5cm (5"), Blade 16mm W \$42.00/ea

JOR228A Stainless Steel. 13.5cm (5"), Blade 10mm W \$42.00/ea



Jorvet Small Lowman Bone Clamp

Developed from standard human Lowman clamp. This clamp grips bone up to 15mm diameter and will also hold small plates in position.

JOR213Q 3" (70mm) length. \$120.00/ea



We do not stock all Orthopedic Products. Note that Jorvet/Jorgensen brand Products have a \$10 Dropship fee, as well as extra overnight fees.

13822 WEST BOULTON BLVD. METTAWA, IL 60045

WWW.SHOPMEDVET.COM

Phone 800-544-7521

268

Fax 800-204-2177

Sterilization, Disinfectants & Cleaners

Iodine Scrub/Solution, Autoclave Tape & Sterilization Pouches



Povidone Iodine Scrub Solution

Generous foaming action helps loosen foreign matter on skin. Rinses easily, leaving no residue. Emollient formulation is soft and non-drying to the skin.

| | | |
|----------|----------|------------|
| PVPSCR-G | 1 Gallon | \$29.99/gl |
| PVPSCR-P | 16oz | \$4.29/ea |



Povidone Iodine Solution

Prep solutions contain 10% weight by volume. Effective for skin and mucous membrane preparation prior to surgical prescrub. Solutions are antimicrobial solutions with surfactants, and contain 7.5% weight by volume Povidone Iodine, USP solution equivalent to 0.75% available iodine. Effective as a surgical scrub or first aid antiseptic.

| | | |
|----------|----------|------------|
| PVPSOL-G | 1 Gallon | \$29.99/gl |
| PVPSOL-P | 16oz | \$4.29/ea |



Surgery Sterilization Pack Wraps

These non-woven, soft but tough surgical wraps are useful for wrapping surgery packs during sterilization and storage. They can also be used for actual surgery drapes in precut sizing. The green Sontara fabric is very durable but economical. It withstands steam sterilization for a superior barrier against air and water borne bacteria.

| | | |
|---------|-----------------|------------|
| JOR258A | 18" x 18", 50pk | \$7.80/pk |
| JOR258B | 24" x 24", 50pk | \$14.00/pk |
| JOR258C | 30" x 30", 50pk | \$20.95/pk |
| JOR258D | 36" x 36", 50pk | \$34.00/pk |
| JOR258E | 45" x 45", 50pk | \$46.00/pk |

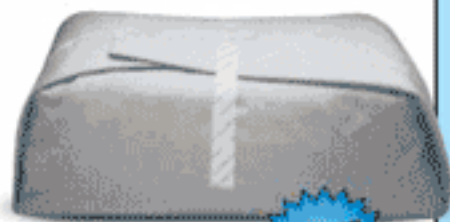

Steam Indicator Strips

Shows a distinctive blue to black color change that is not reversible. Indicated for use in gravity and vacuum cycles

| | | |
|--------|-----------|------------|
| 200100 | 4" 250/bx | \$7.95/bx |
| 200150 | 8" 250/bx | \$12.95/bx |



Steam Autoclave Tape

Sterilizer tape is placed on outside of bag or instrument wrap. Indicates when sterilization is complete. Available in 3 widths. Cut to size as needed.

| | | |
|-------------|---------------|-------------|
| AUTOTAPE1 | 1" x 60 yds | \$3.95/ea |
| AUTOTAPE1/2 | 1/2" x 60 yds | \$3.99/roll |
| AUTOTAPE3/4 | 3/4" x 60 yds | \$3.50/roll |



Sterilization Tubing

Deluxe sterilization rolls with gas/steam indicator. 100 Foot Rolls.

| | | |
|-------|-----------|------------|
| TUBE3 | 3" X 100' | \$7.95/ea |
| TUBE4 | 4" X 100' | \$9.95/ea |
| TUBE6 | 6" X 100' | \$11.95/ea |



Jorvet Sterilization Tubing

Sterilization Tubing for sterile packaging of instruments. Cut off appropriate length from 100' roll. Blue-tinted side for visualization, other side paper-backed. Will work for either ethylene oxide or steam autoclaving.

| | | |
|---------|---------------------|------------|
| JOR481A | 2" x 100', 10 bx/cs | \$11.80/ea |
| JOR481B | 3" x 100', 10 bx/cs | \$13.55/ea |
| JOR481C | 4" x 100', 10 bx/cs | \$17.10/ea |
| JOR481D | 6" x 100', 10 bx/cs | \$20.70/ea |



Sterilization Pouches

Top quality sterilization pouches at low, low prices. Compare our prices to those of others and stock up now to save! Self-Sealing. 200 per box

| | | |
|--------|-------------------------|------------|
| 442090 | 2 3/4" X 10", 200/bx | \$10.50/bx |
| 442100 | 3 1/2" X 5 1/4", 200/bx | \$10.50/bx |
| 442101 | 3 1/2" X 9", 200/bx | \$11.50/bx |
| 442102 | 5 1/4" X 10", 200/bx | \$16.50/bx |
| 442103 | 7 1/2" X 13", 200/bx | \$27.50/bx |
| 442104 | 8" X 16", 200/bx | \$29.95/bx |



Sterilization Pouch

Pre-formed pouches with self-adhering adhesive tape features one blue-tinted side for visualization of contents, with other side paper-backed. Will work with either steam autoclave or ethylene oxide gas sterilization.

| | | |
|---------|------------------------|------------|
| JOR480A | 3.5" x 10", 200-pack | \$23.25/ea |
| JOR480B | 5.25" x 11", 200-pack | \$42.00/ea |
| JOR480C | 7.375" x 13", 200-pack | \$54.50/ea |



Sterilization Envelope

Sterilization Record Envelopes for Steam or Gas Loads Keep Data Organized. Med-Checks' pre-printed 9" x 12" (23cm x 30cm) envelopes are designed for storing Bowie Dick test sheets, recordings and other pertinent data.

| | | |
|------------|--------------|------------|
| MDS2009000 | 9x12" 200/cs | \$53.02/bx |
|------------|--------------|------------|





Instrument Cleaning

Instrument Brush

| | | |
|--------|-----------|-----------|
| 40-200 | Nylon | \$1.80/ea |
| 40-205 | Stainless | \$1.80/ea |
| 40-210 | Brass | \$0.99/ea |

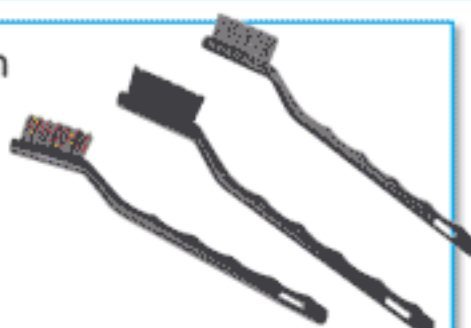

Nylon Brush

For proper cleaning of expensive surgical instruments. These brushes will remove all tissue residue and dried blood from hard to reach areas on surgical instruments.

JOR364 7"L \$1.80/ea

Stainless Steel Brush

Stainless Steel Bristle for burrs and rasps.

JOR364S \$1.80/ea

Double Sided Brush

Double-Sided Brush with both nylon and stainless steel bristles.

JOR364D \$2.25/ea



Foaming Autoclave Cleaner

Foaming Autoclave Cleaner. The steam autoclave is a workhorse in today's veterinary clinic. Its heavy use even with distilled water results in dark brown scale deposits on the inside chamber. If not regularly cleaned, these deposits will foul the surgical pack and affect the performance and longevity of the autoclave. It is recommended to clean the autoclave after every 20 cycles, or once per month if used everyday. The JorClave foaming autoclave cleaner will remove all rust spots, stains, and corrosion. In addition scale, alkaline and mineral deposits on the inside chamber walls of autoclave. It also works well on stainless steel carts, trays, or surfaces.

- Mild acidic solution removes rust, stain, spotting, and corrosion
- Most other solutions are slightly alkaline, but the actual deposits are alkaline in pH.
- Foaming action stays on surface longer than standard liquid spray
- Pump spray goes on easily and quickly
- Restores original finish
- No more noxious odor from walls of autoclave

JOR646 \$12.75/ea



Surgical Instrument Milk

An absolute necessity for lubricating and protecting expensive surgical instruments. Use after every cleaning to extend the life of all types of stainless steel surgical instruments. Contains a special additive which

- dissolves organic debris that may build up in the box lock.
- Inhibits corrosion. Deposits anti-corrosive microfilm onto instrument surface
- Gentle ingredients. Formulated with non-aggressive and near neutral pH (7-8)
- 1 gallon makes 7 gallons of lubricant
- Available 4 gallons/case

JOR648 \$33.00/ea



Pink Germicide

An inexpensive disinfectant that allows the submerged instrument to be quickly used after just 10 minutes. It has an anti-corrosive agent that makes it safe to use with stainless steel instruments.

Germicide's advantages:

- Quaternary ammonium compound
- Fast acting
- Low Toxicity
- Ready-to-use, no dilution needed

JOR883 1 Gallon \$16.50/gl



Nolvasan S Cleaner

For disinfection of inanimate objects to aid in control of numerous canine, bovine, and equine Infectious viruses. Concentrated, mix with clean water.

RXNOLS-16 1 pint \$23.50/btl



Surgical Enzyme Cleaner

This cleaner is excellent for removing stubborn organic debris that can stain your surgical instruments. It is a blend of four different enzymes to be the most effective cleaner available. Free of metal attacking agents. Does not contain scale forming phosphates, chlorides or hydroxides

- Concentrated for best economy. Only 1 oz. (30ml) is needed for 1 gallon of wash solution
- Cleans a wide range of metal surfaces. Safe and effective for stainless steel, aluminum, tungsten carbide, copper and brass instruments
- Available 4 gallons/case

JOR649 1 gallon \$48.00/ea



Instrument Cleaners



Enzymatic Instrument Cleaner (A)

Enzymatic Detergent is a specially formulated presoak and cleaner designed to provide one-step cleaning of delicate fiber optic equipment such as endoscopes and cytoscopes, as well as other surgical instruments including those for eye, cardiovascular and general surgery. It is designed as a soak solution for surgical instruments to be used immediately following their use in a surgical procedure. Hemolytic Neutral pH Bacteriostatic Double Enzyme, Non-corrosive, Free rinsing. Safe for scopes Can be used in ultrasonic cleaners. Cleans hard to reach surfaces One gallon bottle

B9 1 Gallon \$29.95/gl

Ultrasonic Cleaning Solution (B)

Concentrated cleaning solutions are non-ammoniated. This concentrated solution is designed to dilute one part concentrate to ten parts water. It is specially formulated to provide a mild yet effective solution for cleaning instruments. Properly used, it will easily remove blood and other body fluids for longer instrument life. One gallon.

JOR382G 1 Gallon \$56.25/gl

Manual and Ultrasonic Instrument Detergent (C)

This Manual and Ultrasonic Instrument Detergent is specially formulated for both manual and ultrasonic cleaners. It is safe for metals, plastics, glassware and rubber. This LOW FOAM cleaner is designed for use in mechanical washers, disperses quickly, and is well suited for automatic injection systems. When hand processing instruments heavily laden with gross organic debris, the use of this cleaner is recommended prior to disinfecting. It contains no animal enzymes and maintains a pleasant odor. It contains four enzymes and three enhancers that make it exceptionally effective in breaking down protein, blood and fat from lumens, box locks and channels. One Gallon bottle

LSD 1 Gallon \$21.00/gl

Enzymatic Instrument Pre-Cleaner Gel (D)

This product is designed for removal of proteinaceous matter from instruments and medical apparatus by coating these surfaces and sustaining moisture during transporting. Cleaner is biodegradable, non-corrosive, and will not stain instruments or equipment made of glass, metal, plastic or rubber.

ENZ220Z 22 oz \$10.95/btl

Instrument Lubricant (E)

Instrument Lubricant (sometimes called milk or milk bath products) is a ready-to-use product that extends instrument life. It helps keep scissors sharp with regular use, and ensures proper operation of hinges, box locks and joints to inhibit growth of bacteria, yeast and fungi. Just use after cleaning or before sterilization or decontamination.

IL220Z 22oz, ready to use \$10.95/btl

Instrument Lubricant Concentrate (F)

Surgical Instrument Lubricant Milk is used after every use of the instrument. Not only does this product lubricate all moving parts, but it helps prevent spotting, staining and rusting of your most precious instruments. This product is not a detergent or sterilizer. Instruments must be autoclaved after Surgical Instrument Lubricant Milk has been applied. The lubricant bath should be replaced at least weekly or more frequently depending on number of instruments processed. Ingredients: Water Polybutene Oleth-2 Oleic Acid Triethanolamine Methylparaben Propylparaben Hydrogenated Castol Oil One gallon makes SEVEN GALLONS of lubricant

ILG 1 gallon, concentrated \$21.00/gl

Surgical Neutral Detergent (G)

Ultrasonic and manual cleaning detergent for surgical instruments.

- Very concentrated. 5ml makes 1 gallon
- Works on metals, rubber, plastic and glass
- High suds with rust inhibitor
- Dispenser pump included
- Available 4 gallons/case

JOR647 Gallon \$48.00/ea



A



B



C



D



E



F



G



Sterilization, Disinfectants & Cleaners

Sterilization Trays

Jorvet Sterilization Cassette Tray

Useful for sterilizing and for storage between procedures.

JOR973H \$29.00/ea



Compact Dental Instrument Sterilization Cassette

This compact tray holds up to eight dental hand instruments. Fits into ultrasonic cleaners, plus is autoclavable up to 270°F. End covers snap off/on, for easy removal (left off when using a mouth mirror). A locking strap secures instruments.

JOR943C 4" x 7" x 5/8" \$30.40/ea

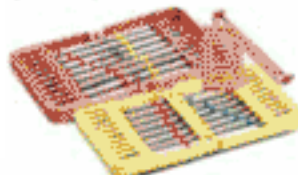

Jorvet Steri Container

A small sterilizable kit that holds a few special instruments. This hinged-lid container fits into ultrasonic cleaners, plus is autoclavable.

JOR943X 8" x 1 3/4" x 1 3/4" \$13.80/ea

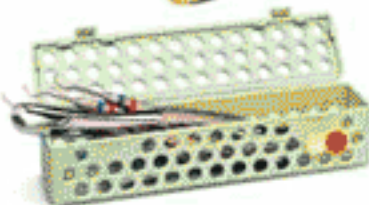

Knife Storage Tray (Sterilization Tray)

This autoclavable tray holds small knives like test or tendon knives via two silicon bars.

JOR667 6" x 21/2" x 3/4" \$30.00/ea

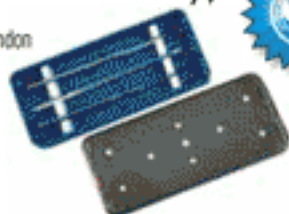

Jorvet Sterilizing Tray

Holds a spay surgery pack.

JOR665L X-Large, Two layers, 15" x 10" x 2 1/2" \$465.00/ea
 JOR665 Large, 15" x 10" x 1" \$280.00/ea



Cold Sterilization Storage Tray

Three piece soaking and sterilization set is ideal for cold soaking instruments. The perforated tray can be lifted out of any solution.

- Stainless steel latches seal the tray
- Can be autoclaved up to 300° F
- Red fiberglass reinforced plastic

JOR369 6" W x 9 3/4" L x 4 1/2" H. \$92.00/ea
 JOR369L 11" W x 17" L x 6" H. \$162.00/ea

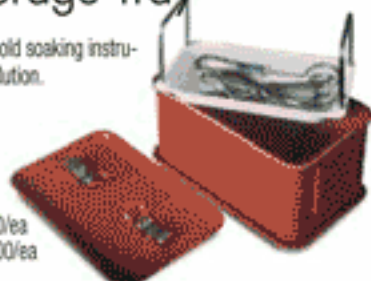

Sterilization Tray

This two layer tray can hold any type of instrument. The rubber mat allows instruments to lay in any configuration. It is autoclavable and can be cold sterilized.

JOR41T Two later tray, 10" x 6" x 1.5" \$158.00/ea

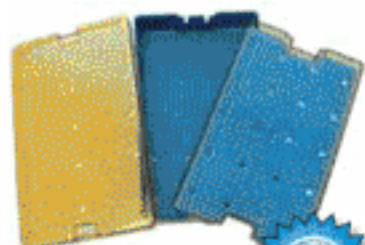

Sterilization Tray w/Mat

Autoclave Tray with rubber mat.

JOR664T 6" X 4" With Mat \$39.00/ea

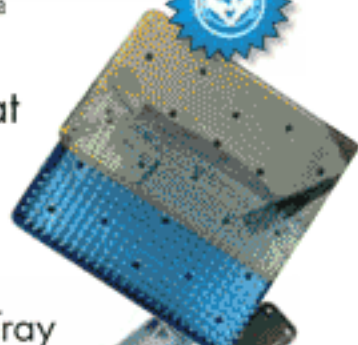

Rigid Endoscope Storage Tray

Two silicone bars hold scope in safe carrying/storage case.

JOR666 16" x 21/2" x 11/2" \$125.00/ea



Jorvet Small Soaking Tray

Cold Sterilization Soaking Trays. Durable plastic made to withstand disinfectants and sterilants. All have drain baskets that allow lifting the tray out of solution and having the solution drain back into the main container. Equipped with fitted sealed lid.

JOR882B 10" x 5" x 3" Grey \$85.00/ea
 JOR882C One-pint volume, 3-1/2" W x 8" L x 2-1/4" H. \$55.00/ea

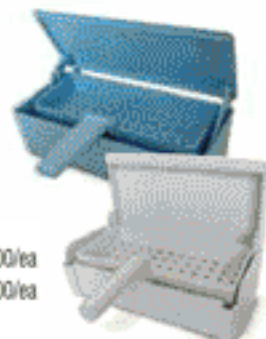

Clear Cold Sterilization Tray

Durable plastic made to withstand disinfectants and sterilants. All have drain baskets that allow lifting the tray out of solution and having the solution drain back into the main container. Equipped with fitted sealed lid.

JOR882 20" x 12" x 6" Large \$196.00/ea
 JOR882A 12" x 10" x 6" Medium \$50.00/ea

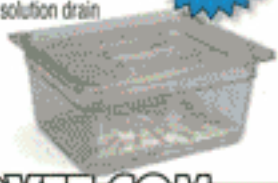

Sterilization, Disinfectants & Cleaners

Disinfectants, Cleaners & Wipes



Germicidal Disinfectant Detergent

A quaternary-based all-purpose bactericidal, virucidal and fungicidal disinfectant detergent with unique neutral pH formula which will not leave a film. Use in veterinary hospitals, kennel rooms, cages and on food and water bowls. Effective against most pathogenic organisms found in veterinary clinics and kennels including Salmonella, Staphylococcus, Pseudomonas, Escherichia coli, Trichophyton, Canine distemper, feline picornavirus, Herpes Simplex Type 1 & 2, HIV-1, HIV-2, Infectious bovine rhinotracheitis, Influenza A2, Pseudorabies and Vaccinia according to the criteria established by the U.S. Environmental Protection Agency for registration and labeling of a disinfectant product as a bactericide, fungicide, or virucide.

RNAL 1 Gallon \$19.95/gl



Cavicide Disinfectant

Cavicide is an effective, ready to use, multi-purpose, broad spectrum solution for use on the surfaces of inanimate objects. Especially useful in O.R.'s, E.R.'s, isolation areas, labs and other critical areas where environmental infection control is necessary.

CV1000 1 Gallon \$26.95/gl
CV1024 24 fl Oz \$10.95/btl



Cavicide Wipes

The power of Cavicide in a wipe! Pre saturated with Cavicide, the cloth wipes are proven to kill both TB and Hepatitis B. Durable, non-woven, non-abrasive towels that don't bunch up during use. Does the job of three products- cleaner, disinfectant and decontaminant. 160 per tub.

CV1100 160 wipes \$10.34/btl



Disinfecting Wipes

For use on Environmental surfaces. Disinfect and Deodorize conveniently with easy pop-up dispenser. For use on hands and nonporous surfaces. 50 Pre-saturated Wipes. Double extra large wipes are three times the size of regular wipes.

DISWIPE 50 wipes \$24.74/ea



Parvosan Disinfectant

RXPARVOSAN gallon \$33.00/gl



Hose End Sprayer

Heavy-duty hose-end sprayer is built tough for professional use. Automatically meters cleaner/ disinfectant concentrate to the exact ratio. Combines attachments for both heavy-duty blasting and foaming. Features a quick-disconnect coupling reservoir.

ACE-950GFMR adjusts to ratios of 0.5, 1, 2, 4.5 and 6 oz/gal



\$72.80/ea

Glutaraldehyde Cold Sterilization Solution

Glutaraldehyde is used as a cold sterilant to disinfect and clean heat-sensitive equipment such as dialysis instruments, surgical instruments, suction bottles, bronchoscopes, endoscopes, and ear, nose, and throat instruments. This chemical can also be used as a tissue fixative in histology and pathology labs and as a hardening agent in the development of x-rays.

| | | |
|--------|-----------------|------------|
| MX1400 | 14 day 1 Gallon | \$21.00/gl |
| MX1405 | 14 day 1 quart | \$9.50/qt |
| MX2800 | 28 day 1 Gallon | \$24.10/gl |
| MX2805 | 28 day 1 quart | \$10.40/qt |



Metrimist Deodorizer

MetriMist is a natural, aromatic deodorizer that eliminates offensive odors by cleaning the air, not masking the smell. MetriMist is non-toxic, biodegradable, non-flammable and safe to use on all surfaces.

MX1151 1 oz spray \$2.39/btl



Disinfectant Cleaner

Surface Disinfectant that kills a wide range of pathogens in ONE MINUTE. Meets OSHA's Bloodborne Pathogen Standard.

DISG 1 Gallon \$23.95/gl
DISQT 1 Quart \$9.95/qt



Wavicide Sterilizing Solution

The preferred solution for items like endoscopes, that cannot be autoclaved. A 30-day, 2.65 percent glutaraldehyde sterilizing solution. It is a true sterilant versus just a disinfectant. Wavicide is similar to other glutaraldehydes (i.e., Johnson and Johnson's Cidex). Wavicide is similar to other solutions as in:

- 2 percent glutaraldehyde solution
- Must preclean instruments before immersion
- Must rinse with sterile water before use
- Wavicide's advantages:
- No separate activator chemical needed
- Ready-to-use, no mixing or shaking
- Unused bottled solution keeps for full year
- 30-day reuse
- Use at room temperature
- Lemon scented

JOR881 quart \$12.90/ea
JOR881G gallon \$36.00/gl



Floor Squeegees

Speed drying of your kennels and floors! "All-surface" neoprene squeegees. Nonmarking heads with a rim splash guard.

ACE-FS-K30 30" neoprene with 55" aluminum handle \$49.73/ea
ACE-FS-K 22" neoprene with 55" aluminum handle \$43.66/ea



Sterilization, Disinfectants & Cleaners

Deodorizers, Antiseptic & Rubbermaid Clean Up



Aerosol Deodorizer

These deodorizers represent the state of the art in odor control. This breakthrough formulation contains all the performance of a dry type freshener but with excellent bloom, greater suspension time, ultra-fine particles and no fallout residue. It is also safe for the ozone. These sprays use only the finest ingredients to insure a fantastic fragrance and superior odor neutralizers that work in seconds on odors from: SMOKE, DECAY, URINE, FECES, SOLVENT, VOMIT, COOKING, ANIMALS AND MORE!!! Each can contains up to 3400 controlled sprays.

| | | | |
|--------|--------------|-----------|--------------|
| 208-12 | Citrus 7 oz | \$4.50/ea | 12+\$3.95/ea |
| 211-12 | Spice 7 oz | \$4.50/ea | 12+\$3.95/ea |
| 217-12 | Vanilla 7 oz | \$4.50/ea | 12+\$3.95/ea |



Aerosol Dispenser

The Stratus 2 Aerosol Dispenser includes:

- 5, 10, 15 and 20 minute multiple spray intervals.
- Day, night and 24 hour operation.
- Unique one battery design lasts for one year under normal conditions.
- Low battery/refill indicators.
- Serves 6000 cubic feet.
- Operates with one "D" alkaline battery (not included).

| | | |
|-----|---------------|------------|
| 999 | Air Dispenser | \$39.99/ea |
|-----|---------------|------------|



Rubbermaid WaveBrake® Mop Bucket with Ringer

The WaveBrake® mop bucket and wringer system reduces splashing, which means a safer environment, cleaner floors, and improved productivity.

- High efficiency side press wringer.
- Lasts 58 times longer than comparative wringers.
- Tested to exceed 50,000 wringing cycles, average wringers perform approximately 860 cycles.
- Premium tubular steel and Structural Web molded plastic.

| | | |
|---------|---------------------------|------------|
| 7480-10 | 26 qt. mop bucket wringer | \$66.49/ea |
|---------|---------------------------|------------|

Rubbermaid® Mop Heads

For disinfection of inanimate objects to aid in control of numerous canine, bovine, and equine Infectious viruses. Concentrated, mix with clean water.

| | | |
|---------|-----------------|------------|
| V118-71 | Mop Head, 3/pkg | \$11.49/pk |
|---------|-----------------|------------|

Rubbermaid® Mop Handle

| | | |
|---------|------------------------------|------------|
| U716-71 | Rubbermaid Mop Handle w/Head | \$13.69/ea |
|---------|------------------------------|------------|



Antiseptic Hand Gel

70% ethyl alcohol. Helps prevent cross-contamination when soap and water are not available. Fast-acting, waterless. No sticky or tacky residue.

| | | |
|------|-------|------------|
| AGEL | 18 oz | \$9.95/btl |
|------|-------|------------|



Hand Antiseptic

| | | |
|-----------|---------------------------------|-----------|
| MSC097040 | Foaming Instant Hand Sanitizer. | \$5.99/ea |
|-----------|---------------------------------|-----------|

Antiseptic Towelette

Towelettes provide both an antiseptic and bactericidal with cleansing action. Benzalkonium chloride is ideal for general antiseptic cleaning. Cleansing towelettes are perfect for quick, antiseptic cleansing for patients and staff. Castile soap towelettes are either used for general cleansing or cleansing the perineal area before collection of any clean-catch urine specimens.

| | | |
|-------|--------|-----------|
| AT100 | 100/bx | \$2.99/bx |
|-------|--------|-----------|



Castile Soap Towelette

Gentle cleansing agent, pH balanced.

| | | |
|------|--------|-----------|
| 1304 | 100/bx | \$2.99/bx |
|------|--------|-----------|



Obstetrical Towelette

Obstetrical towelette for gentle cleansing throughout parturition process or whenever cleansing/refreshing is required. Contains benzalkonium chloride solution 1:250, to yield 1:750, Alcohol 5%, Chlorothymol.

| | | |
|------|------------------|-----------|
| 1302 | 5" x 7", 100/box | \$2.29/bx |
|------|------------------|-----------|



Cleansing Towelette

Cleansing towelette for general wash-up...cleans and refreshes hands, face and body without soap and water. Contains alcohol 5%, benzalkonium chloride 1:200.

| | | |
|------|------------------|-----------|
| 1301 | 5" X 7", 100/Box | \$2.29/bx |
|------|------------------|-----------|



Nice n' Fresh Moist Towelettes

Antiseptic towelette for general wash-up in convenient pop-up canister. 20% Alcohol content. 70 per canister.

| | | |
|------|-----------------------------------|-----------|
| 1305 | 5.5" x 8", Pop Up Canister, 70/ct | \$2.29/ct |
|------|-----------------------------------|-----------|



Sterilization, Disinfectants & Cleaners

All American Portable Sterilizer



A complete self-contained sterilizer with an immersion heating element, automatic thermostatic control, automatic release valve and pilot light. First in the field to develop an immersion type Pressure Sterilizer for all physicians' offices, hospitals and laboratories. Connects to any outlet and ready for use instantly. This compact and portable unit will quickly pay for its low cost in the saving of time alone. There are no additional supplies to purchase nor is there any maintenance cost other than the electric power consumed. The sterilizer is made of a high quality cast aluminum alloy with the special features of the famous ALL-AMERICAN Pressure Cookers. The portable electric automatic sterilizer meets all requirements for physicians, dentists, first aid stations, hospitals and laboratories. It will provide a complete and efficient sterilization facility with an extremely low cost. The ALL-AMERICAN Sterilizer is automatic in operation, controlled by a Fenwal thermostat and pilot light. Only a small amount of water is needed to create the dry steam. At a temperature of 250 degrees F. or 15 P.S.I., it penetrates the bandages or instruments, making them sterile in 30 minutes. (note: Sterilization time count begins when temperature and pressure levels are reached.)

- Available in 120v or 240v
- Operational on 50hz or 60hz
- Calrod immersion heating element
- 120 Volt AC, 1050 watt, 8 3/4 amps or 240 Volt AC, 1050 watt, 4.38 amps
- Fenwal thermostatic control
- Heavy cast aluminum cover & bottom construction
- Aluminum alloy seamless inset container
- Large sterilizing capacity (831 cubic inches)
- Aluminum rack
- Complete and effective sterilization at lowest possible cost
- Flexible metal exhaust tube
- Dial gauge and control valve
- 3-wire grounded cord and plug for safety
- Metal-to-metal seal (no rubber gaskets)
- Shipping weight: 30 lbs
- Packed in individual corrugated cartons



**TOP
SELLER**



| | | |
|--------------------|-----------------------|-------------|
| 25X-120V | 120 Volt | \$828.00/ea |
| 25X-240V | 240 Volt | \$848.00/ea |
| Accessories | | |
| 25X-2156 | Aluminum Inner Basket | \$61.20/ea |
| GAUGE-S | Steam Gauge | \$15.50/ea |

Ultrasonic Cleaner

For the highest quality specialized instruments we now introduce a premium line of ultrasonic cleaners and cleaning solutions that keep your instruments spotless for longer lasting performance. What is ultrasonic cleaning and how does it work? High frequency sound waves are used to produce more than 40,000 alternating high and low pressures per second. As these waves travel through a specially formulated cleaning solution, millions of microscopic bubbles form and violently implode. This process, known as cavitation, creates a scrubbing action capable of cleaning up to 16 times more efficiently than hand scrubbing. In minutes, all body fluids and foreign particles are removed, even from the tightest grooves, cracks and interior surfaces of the instrument being cleaned. These ultrasonic cleaning systems represent the most advanced technology in ultrasonic cleaning available today.

Features:

Heavy-duty transducer. 25 percent heavier. Providing greater power and better dissolution in the tank.

- Operation at higher Hz. Cleaner operates at 60,000 Hz. This higher Hz equals a short wave-length that increases efficiency in cleaning small crevices. Standard units operate at 35,000-40,000 Hz.
- Extended limited warranty of 2 1/2 years.



| | | |
|----------|---------------------------------------|-------------|
| JOR382A | Standard 3-3/8 Quarts unit | \$680.00/ea |
| JOR382AB | Standard 3-3/8qt Basket | \$153.00/ea |
| JOR382B | 1- 1/2 gallon Unit | \$996.00/ea |
| JOR382BB | Deluxe 1-1/2 gallon Basket (Optional) | \$169.50/ea |

13822 WEST BOULTON BLVD. METTAWA, IL 60045

WWW.SHOPMEDVET.COM

Phone 800-544-7521

275

Fax 800-204-2177

Odor Control

KOE Kennel Odor Eliminator Concentrate

Eliminates, not masks, odors. It even works on old, impregnated odors from cages, runs, walls and other large areas. Creates a mild, outdoor fresh odor. Concentrate (0.25 oz per gallon of water)

| | | |
|-------|--------|-------------|
| KOE | 8oz | \$10.95/btl |
| KOE-G | gallon | \$79.00/gl |



AOE Deodorizing Wipes

Eliminates, not masks, odors from anal gland secretion, tom cat spray, necrotic tissue, urine, feces, emesis, etc. Used on animals, accidents, bedding, cages, litter or any place with companion malodor. Spray directly on the source of the odor. Can also be used as an air freshener. Ideal for deodorizing cat litter boxes and neutralizing tomcat spray in the home.

| | | |
|-------|---------------|------------|
| AOE-W | 80 wipes/pack | \$7.95/pk |
| AOE-S | 8oz | \$4.50/btl |



Cat-Odor Off

Eliminates animal odors in carpets, upholstery and other porous surfaces from urine, tomcat spray, feces, emesis and more. Works where other products haven't and won't. Contains no enzymes so may be used without loss of efficacy with or after detergents (carpet shampoo) and germicides. Soaker, penetrates to the source of the odor. Sprays and powders only treat surface problems. Removes many Stains.

| | | |
|-------|------------------|-------------|
| CO-O | 16oz | \$5.00/btl |
| CO-OC | 16oz concentrate | \$11.99/btl |



Dog-Odor Off

Eliminates undignified dog odors including normal body odors, urine, feces, emesis and necrotic tissue. Used on dogs, accidents, cages, bedding or anywhere there is an animal related odor problem. Not an enzyme, bacteria or mask thus may be used after shampoos, cleaners, germicides without loss of efficacy. Eliminates odors without bathing. Fleas and ticks hate its natural cedar fragrance. Works better than cedar bedding because it stays with the dog wherever it goes.

| | | |
|-------|-----------|------------|
| DO-O | 8oz spray | \$4.50/btl |
| DO-OC | 16oz | \$4.85/btl |



OdorzOut

OdorzOut products consist of a blend of Zeolites. They have a honeycomb-like structure with pores which absorb and trap unpleasant and noxious odors. Zeolites have a negative molecular charge which attracts the dust particles, which in turn will eliminate the unwelcome odors. Zeolites unusual longevity is a result of millions of tiny micro-pores that give the material a great absorbent surface.

| | | |
|----------|----------------------------|------------|
| OAPG-875 | All Purpose Granules, 875g | \$18.95/ea |
| OPP-799 | Powder, 755g | \$18.95/ea |



Skunk-Off

Stops skunk odor instantly and permanently on contact. Removes all traces of skunk spray from dogs, other pets, people, clothes, cars, homes, anybody or anything a skunk has sprayed or anything a skunk-sprayed animal has rubbed against. Safe, will not damage or irritate sensitive tissue of eyes, ears or nose. Liquid is applied full strength as a spray or soaker from the easy-to-use squeeze bottle. Shampoo is thoroughly applied to the entire animal and then rinsed.

| | | |
|-----|-------------------|-------------|
| S08 | 8oz liquid soaker | \$4.59/btl |
| S00 | 32oz liquid spray | \$19.99/btl |
| S05 | 8oz shampoo | \$5.05/btl |



Citrus II Deodorizer

Citrus spray leaves a fresh, clean, citrus scent that is neither too overpowering or too weak. Excellent to have on hand to freshen up the room during the summer! Room Deodorant Non-Aerosol.

| | | |
|-------|------------|------------|
| CT40Z | 4oz bottle | \$5.99/btl |
| CT70Z | 7oz bottle | \$7.99/btl |



Sterile Swann-Morton Scalpel Blades

Made from the finest carbon steel. Sizes stocked: 10,11, 12, 15, 20, 21, and 22. These sharp blades are the result of years of experience plus modern production methods. Individually wrapped. 100/pkg.

| | | |
|---------|------------------|------------|
| JCR54SD | size 15, 100/pkg | \$28.50/bx |
|---------|------------------|------------|



Stethoscopes



Littmann Classic II S.E Stethoscope

Featuring a two-sided chest piece, the Littmann Classic II S.E. Stethoscope offers high acoustic sensitivity for superior performance. A tunable diaphragm on one side augments the traditional bell function of the opposite side. Traditional bell combined with a tunable diaphragm that conveniently alternates between low- and high-frequency sounds without the need to turn over the chest piece

- Excellent acoustic seal and comfortable fit with patented 3M Littmann® Snap Tight Soft-Sealing Eartips
- Comfortably angled, anatomically correct headset
- Patient-friendly, non chill rim and diaphragm
- Single-lumen tubing in multiple colors
- Three-year warranty

| | | |
|------|----------------------|------------|
| 2201 | Black, 28"L | \$94.45/ea |
| 2203 | Gray, 28"L | \$94.45/ea |
| 2205 | Navy, 28"L | \$94.45/ea |
| 2206 | Caribbean Blue, 28"L | \$94.45/ea |
| 2208 | Hunter Green, 28"L | \$94.45/ea |
| 2209 | Purple, 28"L | \$94.45/ea |
| 2211 | Burgundy, 28"L | \$94.45/ea |
| 2210 | Raspberry, 28"L | \$94.45/ea |



Dual Head Stethoscope

This quality stethoscope features chrome binaural silver chest piece, 22" Y tubing and a pair of mushroom ear tips. Overall length is 30". No color choice.

STDH Dual Head, 28"L \$8.99/ea



Single Head Stethoscope

Offers an economical solution for those situations that require a quality listening device. Features a chrome binaural silver chest piece, 22" Y-tubing and a pair of mushroom eartips. Overall length is 30". Single head. No color choice.

STN Single Head, 30"L \$5.99/ea



Sprague-Rappaport Stethoscope

The most popular stethoscope on the market today. Heavy walled 22" tubing blocks out extraneous sounds even in the noisiest conditions. The overall length is 32". No color choice.

STSR Sprague-Rappaport, 22"L \$15.90/ea



Littmann Select Stethoscope

This unique patented chest piece is specifically designed for healthcare professionals general examination needs including heart, lung, blood pressure and other body sounds. Only 3M™ Littman™ delivers this degree of excellence in a stethoscope.

| | | |
|------|----------------------|------------|
| 2290 | Black, 28"L | \$57.65/ea |
| 2291 | Caribbean Blue, 28"L | \$57.65/ea |
| 2293 | Burgundy, 28"L | \$57.65/ea |
| 2294 | Purple, 28"L | \$57.65/ea |
| 2298 | Royal Blue, 28"L | \$57.65/ea |



JorVet Dual Head Stethoscope

Affordable stethoscope with great performance

- Dual head swivels for cardiac exams and breathing
- Auscultation
- Wide range of fun colors.
- 30" Long tubing length.

| | | |
|---------|------------|------------|
| JOR205G | Gray, 30"L | \$24.15/ea |
| JOR205R | Red, 30"L | \$24.15/ea |



Littmann Master Cardiology Stethoscope

A tunable diaphragm and superb craftsmanship offers the ultimate performance in a superior stethoscope. The Littmann Master Cardiology stethoscope meets the exacting standards of healthcare professionals who demand very high acoustic response.

- Tunable diaphragm conveniently alternates between low and high-frequency sounds without the need to turn over the chest piece
- Handcrafted solid stainless steel chest piece
- Two-in-one tube design eliminates tube rubbing noise
- Portable convenience of a single-sided chest piece
- Excellent acoustic seal and comfortable fit with patented 3M Littmann® Snap Tight Soft-Sealing Eartips
- Comfortably angled, anatomically correct headset
- Patient-friendly, non chill rim and diaphragm.
- Special procedures adaptor for difficult site or pediatric auscultation
- Available in multiple tube colors
- Seven-year warranty

| | | |
|------|--------------------|-------------|
| 2160 | Black, 27"L | \$249.15/ea |
| 2163 | Burgundy, 27"L | \$249.15/ea |
| 2164 | Navy, 27"L | \$249.15/ea |
| 2165 | Hunter Green, 27"L | \$249.15/ea |





Littmann Master Classic II Stethoscope

The excellent acoustic sensitivity of a tunable diaphragm is the hallmark of the low-profile Littmann Master Classic II stethoscope. Award-winning design combines high performance and portable convenience in this stethoscope with a single-sided chest piece.

- Tunable diaphragm conveniently alternates between low- and high-frequency sounds without the need to turn over the chest piece.
- Excellent acoustic seal and comfortable fit with patented 3M™ Littmann® Snap Tight Soft-Sealing Eartips.
- Portable convenience of a single-sided chest piece.
- Comfortably angled, anatomically correct headset.
- Patient-friendly, non-chill rim and diaphragm.
- High-performance, single-lumen tubing in multiple colors.
- Three-year warranty.



| | | |
|-------|----------------------|-------------|
| 2143 | Purple, 28"L | \$130.65/ea |
| 2144L | Black, 28"L | \$130.65/ea |
| 2146 | Burgundy, 28"L | \$130.65/ea |
| 2147 | Navy, 28"L | \$130.65/ea |
| 2630 | Caribbean Blue, 28"L | \$130.65/ea |
| 2632 | Hunter Green, 28"L | \$130.65/ea |



Littmann Cardiology III Stethoscope

Outstanding acoustic performance and exceptional versatility characterize the Littmann Cardiology III stethoscope. The innovative design offers a tunable diaphragm on each side of the chest piece. The large side can be used for adult patients, while the small side is especially useful for pediatric or thin patients, around bandages, and carotid assessment.

- Two tunable diaphragms conveniently alternate between low- and high-frequency sounds without turning over the chest piece.
- Solid stainless steel chest piece.
- Two-in-one tube design eliminates tube rubbing noise.
- Excellent acoustic seal and comfortable fit with patented 3M™ Littmann® Snap Tight Soft-Sealing Eartips.
- Comfortably angled, anatomically correct headset.
- Patient-friendly, non-chill rim and diaphragm.
- Available in multiple tube colors.
- Five-year warranty.



| | | |
|------|--------------------|-------------|
| 3128 | Black, 27"L | \$206.20/ea |
| 3129 | Burgundy, 27"L | \$206.20/ea |
| 3130 | Navy, 27"L | \$206.20/ea |
| 3134 | Hunter Green, 27"L | \$206.20/ea |



Littmann Classic II S.E. Combination Kits



Littman™ Match Mates kit
INCLUDES:

- Littman Classic II S.E. scope.
- Easy to read gauge with luminescent dial.
- Color coordinated adult-size nylon cuff and zippered carrying case.

| | | |
|------------|--------------|-------------|
| 12-260-021 | Black | \$139.55/ea |
| 12-260-071 | Burgundy | \$139.55/ea |
| 12-260-201 | Purple | \$139.55/ea |
| 12-260-241 | Navy | \$139.55/ea |
| 12-260-251 | Hunter Green | \$139.55/ea |

Littman Classic S.E. II Stethoscope
FEATURES:

- Traditional bell combined with the patented tunable diaphragm.
- Single-lumen tubing.
- Non-chill rim.
- Soft-sealing eartips.
- Three-year stethoscope warranty.



FREE GIFTS with your purchases

Your Choice
(1) \$100 American Express (with \$2,000 Purchase OR)
(1) Digital Camera (with \$1000 Purchase OR)
(1) US Savings Bond (with Qualifying Purchase)

13822 WEST BOULTON BLVD. METTAWA, IL 60045

WWW.SHOPMEDVET.COM

Phone 800-544-7521

278

Fax 800-204-2177

Stethoscopes & Laryngoscope Blades



Ultrascope Stethoscope



Enormously popular in the human medical field. The stethoscope head is pressure sensitive for assessment of heart and lung sounds. The scope will filter noises, such as barking dogs, while amplifying heart and lung sounds. Combines great acoustics with your choice of 15 custom colors (call for choice of color) & 25 custom designed heads. Features cardiology style tubing. Total weight 4 oz. The head design features an acoustic resonant amplifier with frequency range 20- 35 kHz and solid acrylic one-piece design weighing 2 oz. Ultrascoopes are custom made to order, therefore they are non-returnable. NOTE: If diaphragm wears out due to normal wear, it will be replaced for free.

| | | |
|-----------|---|-------------|
| JOR205U | Head, Regular, 2" diaphragm. | \$97.00/ea |
| JOR205UC | Ultrascope Classic Stethoscope. 1- Binaural Tubing, 1 head/2 stems for "experienced, mature users". | \$114.00/ea |
| JOR205UD | Duo Stethoscope. Two same or different size heads, one tubing. | \$154.00/ea |
| JOR205ULA | Large Animal Stethoscope. Includes two extension tubes, maximum 50"L. | \$134.00/ea |
| JOR205UN | Head, Neonatal. 1/2" diaphragm. Clear or color swirl. | \$97.00/ea |
| JOR205UP | Head, Pediatric. 1 1/4" diaphragm. | \$97.00/ea |
| JOR205UT | Trio Stethoscope. Three same or different size heads, one tubing. | \$205.00/ea |
| JOR205UTE | Teaching Stethoscope. Includes two binaural tubings for both instructor and student. | \$108.00/ea |



Custom Heads. Additional designer heads, background colors, and engraving available upon request.



Custom Tubing, 29"L. Other colors available upon request. Latex free!

Ultrascope Stethoscope Parts

| | | |
|-----------|----------------------------------|------------|
| JOR205UE | Custom engraving for Ultrascope. | \$14.00/ea |
| JOR205UET | Ear-tips only for JOR205U | \$4.50/ea |

JOR205UTE



JOR205U



JOR205UC



Miller Laryngoscope Blade

Straight shaft with gentle curved tip.

| | | |
|---------|-------|------------|
| JOR449A | 53mm | \$54.00/ea |
| JOR449B | 80mm | \$54.00/ea |
| JOR449C | 130mm | \$54.00/ea |
| JOR449D | 173mm | \$54.00/ea |
| JOR449E | 180mm | \$54.00/ea |

Designed to work for swine intubations. **Not Pictured**

| | | |
|---------|------------|------------|
| JOR449F | 12" Length | \$84.00/ea |
|---------|------------|------------|



McIntosh Laryngoscope Blade

Curved along entire length of blade.

| | | |
|----------|-------|------------|
| JOR449AM | 60mm | \$39.00/ea |
| JOR449BM | 66mm | \$39.00/ea |
| JOR449CM | 85mm | \$39.00/ea |
| JOR449DM | 110mm | \$39.00/ea |
| JOR449EM | 140mm | \$39.00/ea |



Laryngoscope Handle

Special Pentlight Handle only. Works great for cats.

| | | |
|---------|-----------------------|------------|
| JOR449P | Uses 2-AA batteries | \$30.00/ea |
| JOR449M | Uses 2 "C" batteries. | \$30.00/ea |



Laryngoscope Replacement Light Bulb.

| | | |
|----------|--|-----------|
| JOR449R | Short Bulb. Used for JOR449a through JOR449em blades. Sizes 10mm and 3mm. | \$7.50/ea |
| JOR449RL | Long Bulb. Used for JOR449b through JOR449f and JOR449bm through JOR449em blades. Sizes 12 mm and 6mm. | \$9.00/ea |



Rechargeable Battery

| | | |
|-------|-------------------|------------|
| 72000 | Welch Allyn, 2.5v | \$40.00/ea |
|-------|-------------------|------------|

Otosopes & Ophthalmoscopes



Diagnostic Set

Medium battery handle.

Uses two "C" (2.5v) batteries (not included)

- Otoscope head, 4x magnification
- Three veterinary long specula
- 80mm x 6mm
- 80mm x 4mm
- 58mm x 5mm
- One spare bulb
- One ophthalmoscope head
- Case



JOR45 Uses two "C" (2.5v) batteries \$169.00/ea

Otoscope

Gowland's Otoscope with veterinary length specula.

JOR45A 4x. Uses two "C" batteries \$146.00/ea



Otoscope Cone

Use cold sterilization only. For use with lightsource

JOR114S For use with lightsource JOR114bh \$5.40



Otoscope Cone

23834 4mm, Welch Allyn, Macroview Otoscope \$5.50/ea

23835 5mm, Welch Allyn, Macroview \$5.50/ea

Welch Allyn Diagnostic Kit

WelchAllyn®

We offer two Welch Allyn Diagnostic Kits, each comes complete with a standard ophthalmoscope, choice of otoscope, a direct plug-in rechargeable handle and a soft case. Set One includes:

- 3.5v standard ophthalmoscope.
- 3.5v otoscope (operating or pneu), complete with three polypropylene specula sizes 4, 5 and 7mm.
- Direct plug-in rechargeable 3.5v handle, 100-130v, 50/60Hz.

96121 Kit w/Pneumatic otoscope \$607.16/ea

96171 Kit w/Operating otoscope \$711.17/ea



Reister Diagnostic Kit

The Reister Diagnostic Kit offers a battery operated bayonet with multiple instrument heads.

Operates with two "C" batteries (not included)

This kit includes:

- Chrome-plated bent arm illuminator.
- Two chrome-plated Laryngeal Mirrors (3.0mm & 4.0mm).
- May ophthalmoscope with lens wheel and correcting lens diopter ranging from -20 to +20.
- Chrome-plated nasal speculum that manually opens & closes.
- Chrome-plated otoscope.
- Three reusable specula.
- Swivel magnifying lens and an outlet for pneumatic testing.
- Chrome-plated tongue blade holder that holds wooden & plastic blades.
- Traditional hard storage case.



20-205 Complete Kit \$216.35/ea

Otoscope/Ophthalmoscope Combo Kit

This outstanding Ri-Mini Combination Kit features both an otoscope and an ophthalmoscope and includes a connector for pneumatic testing, replacement ear specula, replaceable 2.5V halogen lamp and is packaged in a traditional hard storage case. Operates with two AA batteries (not included).

20-312 Combo Kit \$272.75/ea



Ri-Mini Ophthalmoscope

The Reister Ri-Mini Ophthalmoscope is designed for the examination of the eye and its background. Correcting lenses with diopter ranges of 0 to +20 and 0 to -20 can be adjusted on the lens wheel and four different aperture and/or filters can be selected. Operates with two "AA" batteries (not included).

20-311 Mini-Ophthalmoscope \$180.00/ea



Reister Otoscope

The Reister Economy Otoscope offers superior optics and craftsmanship. Unit comes complete with bayonet otoscope head, three reusable specula, swivel magnifying lens, and comes in a vinyl storage pouch. Operates with two C batteries (not included).

20-660 Reister Kit \$81.80/ea



Replacement Otoscope Bulb

Replacement Bulb

23-390 Fits 20-660 Otoscope \$7.50/ea

23-600 Fits #20-310 Otoscope \$20.00/ea

23-605 Fits #20-311 Otoscope \$25.00/ea



Ri-Mini Otoscope

When combined with an ear speculum, the Reister Ri-Mini Otoscope is the ideal instrument to use for lighting and examining the auditory canal. Includes replaceable 2.5V halogen lamp and traditional hard storage case. Operates with "AA" batteries (not included).

20-310 Mini-Otoscope \$125.45/ea



Otosopes & Ophthalmoscopes



Welch Allyn 3.5V Coaxial Ophthalmoscope Head

The Welch Allyn ophthalmoscope comes with a Halogen HPXTM lamp that provides 30% more light output, for true tissue color and consistent, long-lasting illumination, coaxial optical system for shadow-free spot and easier entry into undilated pupil, crossed linear polarizing filter to reduce corneal reflection, red-free filter for use with any aperture, 18 possible aperture combinations for greater versatility and sealed optics. Handle not included.



| | | |
|-------|------------------------|-------------|
| 11720 | Coaxial Ophthalmoscope | \$258.94/ea |
| 11730 | AutoStep Coaxial | \$310.73/ea |

Welch Allyn 3.5V Standard Ophthalmoscope Head

The Welch Allyn ophthalmoscope comes with a halogen light for true tissue color and consistent, long-lasting illumination. Six aperture selections for general and specialty uses, 28 lenses (-25 to +40 diopters) for better resolution, rubber brow rest and illuminated lens dial clearly identifying setting. Handle not included.



| | | |
|-------|-----------|-------------|
| 11710 | Head Only | \$238.40/ea |
|-------|-----------|-------------|

Welch Allyn 3.5v Rechargeable Handle

These Welch Allyn 3.5v rechargeable handles are universal, accepting all Welch Allyn 3.5 instrument heads. Chrome plated with smooth, non-abrasive knurled finishes to ensure a no-slip grip, well-balanced and fit comfortably in the hand with the weight distributed evenly end to end, come with a long-lasting nickle-cadmium battery, have a safety switch to prevent accidental draining of the battery and metal head connectors for durability.



| | | |
|---------|--------------|-------------|
| 71000-A | Handle, 3.5V | \$151.78/ea |
|---------|--------------|-------------|



Welch Allyn Diagnostic 2.5V Otoposcope with Specula

This Welch Allyn 2.5v Diagnostic Otoposcope uses a halogen light for true tissue color and consistent, long-lasting illumination. Its fiber-optics produce cool light with no reflection, no obstruction. The wide angle viewing lens allows instrumentation under magnification.



| | | |
|-------|-----------|-------------|
| 24031 | Head Only | \$151.79/ea |
|-------|-----------|-------------|

Digital MacroView™ Veterinary Otoposcope

The Welch Allyn Digital MacroView™ Veterinary Otoposcope is a simple, affordable tool that lets you see, explain, and save digital images of the ear.

Improves

- Communication which can lead to better client compliance
- Gives you an excellent training aid for educational purposes
- Offers you the ability to view small details of ears, mouth, and teeth
- Allows you to store digital images in patient records for enhanced documentation of exam findings
- Provides you the ability to share images with other providers as visual descriptive reference
- Compatible with all Welch Allyn 3.5 V power sources



| | |
|-------|---------------|
| 23960 | \$2,200.00/ea |
|-------|---------------|



Welch Allyn 3.5V Pneumatic Consulting Otoposcope Head

The Welch Allyn Pneumatic Consulting Otoposcope comes with a Halogen HPXTM lamp that provides 30% more light output, for true tissue color and consistent, long-lasting illumination, two viewing lenses for dual observation, teaching and consulting, fiber-optic illumination for cool light, a sealed system for pneumatic otoscopy and a rotatable head for left and right side viewing. Handle not included. Comes with 3 polypropylene specula: sizes 4, 5 & 7mm.



| | | |
|-------|-----------|-------------|
| 20262 | Head Only | \$496.19/ea |
| 20260 | Head Only | \$231.98/ea |

Welch Allyn 3.5V Operating Otoposcope Head

The Welch Allyn Pneumatic Otoposcope comes with a Halogen HPXTM lamp that provides 30% more light output, for true tissue color and consistent, long-lasting illumination, open system for convenience during procedures, rotatable lens and speculum for ease of use and fiber-optic illumination for cool light. Handle not included. Comes with 3 polypropylene specula: sizes 4, 5 & 7mm.



| | | |
|-------|-----------|-------------|
| 21760 | Head Only | \$227.46/ea |
|-------|-----------|-------------|





Pocket scopes & Bulbs

Welch Allyn Pocketscope Power Sources

- Adjustable rheostat controls light intensity.
- Compact pocket clip.
- Accepts all Welch Allyn 2.5v PocketScope instrument heads.
- Compact, lightweight, well-balanced, and comfortable in the hand.

| | | |
|-------|---------------------------------------|-------------|
| 72800 | Handle with Rechargeable Battery | \$121.43/ea |
| 72600 | 2.5V Battery only | \$37.01/ea |
| 72801 | Handle without Battery | \$86.61/ea |
| 72830 | Handle with AA Batteries | \$65.19/ea |
| 79290 | Desk Charger, 2.5V, 100-130V, 50-60HZ | \$327.96/ea |



Welch Allyn Pocketscope 2.5V Otoscope

The Welch Allyn 2.5v PocketScope™ Ophthalmoscope features a halogen light for true tissue color and consistent, long-lasting illumination, built-in throat illuminator/penlight, wide angle viewing lens for instrumentation under magnification, sealed system for pneumatic otoscopy and fiber-optic illumination for cool light with no reflections or obstructions and is compact.

| | | |
|-------|------------------------|-------------|
| 22800 | Rechargeable batteries | \$240.19/ea |
| 22820 | Uses 2 AA batteries | \$210.71/ea |



Welch Allyn 3.5v Rechargeable Battery

Replacement NiCad Rechargeable Battery

| | | |
|-------|--------------------------|------------|
| 72200 | 3.5V | \$45.79/ea |
| 72300 | 3.5V FOR 71000A & 71000C | \$45.79/ea |

WelchAllyn®

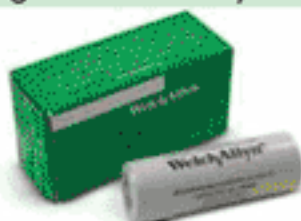

Vacuum Lamp

Welch Allyn® 7v Vacuum Lamp Model 02000-U

| | | |
|---------|------------------|-----------|
| 02000-U | For light# 45003 | \$4.14/ea |
|---------|------------------|-----------|



Welch Allyn 2.5v Pocketscope Ophthalmoscope

The Welch Allyn 2.5v PocketScope™ Ophthalmoscope features a halogen light for true tissue color and consistent, long-lasting illumination, 5 aperture selections for general and specialist use, 48 lenses for better resolution, a polarized filter to reduce corneal reflection and is compact.

| | | |
|-------|---------------------------|-------------|
| 12800 | with rechargeable battery | \$295.54/ea |
| 12820 | with AA battery | \$271.20/ea |



Welch Allyn Desk Charger

Featuring advanced circuitry for consistent automatic safe charging and optimum lamp performance and life. They are compact for easy mobility and convenience and come with optional wall brackets for permanent mounting on walls or cabinets. Charger fits both 3.5v and 2.5v handles. Available with internal specula tray (5" x 7" x 2 1/4").

| | | |
|-------|-------------------------|-------------|
| 71140 | Charger | \$233.04/ea |
| 71630 | Holds 2 3.5V Handles Wa | \$490.20/ea |

WelchAllyn®



Indirect Viewing Lens

Jorvet

Aspheric 20 diopter hand held lens. This 20 diopter all glass indirect convex lens combined with a source of direct illumination i.e. bright penlight allows for 'indirect' ophthalmoscopy of the fundus. The veterinarian holds the lens in front of the animal's eye. At arm's length, the veterinarian direct light at lens:

- Provides a larger field of view of the fundus than is possible with a standard ophthalmoscope
- Exam at safe distance with fractious animals
- Comes with blue velour storage bag

| | | |
|--------|-----------------------|------------|
| JOR992 | 2 1/2" d x 1/2" thick | \$52.00/ea |
|--------|-----------------------|------------|



Illuminators, Speculums & Bulbs



Welch Allyn 3.5v Wall Transformer

The 767 Wall Transformer is designed to put everything needed for fast, accurate diagnoses at arm's length. And it does this in a convenient, modular package. Features handle-based rheostat for quick light-intensity adjustments, contoured handles that are easy to hold and maneuver, a high-impact ABS housing, modular coiled cords that are guaranteed for 10 years and new Halogen HPX lamps that provide 30% more light.



| | | |
|-------|-----------------------------|-------------|
| 76710 | Wall Transformer | \$466.09/ea |
| 76720 | Wall Transformer with clock | \$525.01/ea |
| 76730 | Third Handle Module | \$260.23/ea |
| 71420 | Bracket | \$56.26/ea |

WelchAllyn®

Welch Allyn IndirectViewing Lens

20 diopter all-glass indirect convex viewing lens allows for less distortion while providing for a larger field of view. Allows for examination at a safe distance from fractious animals. Combined with a source of direct illumination, allows a veterinarian to perform monocular indirect ophthalmoscopy. At arms length, the examiner directs light on the viewing lens, which then reveals an inverted picture of the fundus.

| | | |
|-------|------------|------------|
| 12300 | 20 Diopter | \$81.60/ea |
|-------|------------|------------|



WelchAllyn®

Polypropylene Specula

The material used in the Welch Allyn Reusable Polypropylene Specula is lightweight but durable. The specula may be autoclaved, boiled, or sterilized in solution and can be attached easily.

| | | |
|---------|-----|-----------|
| 24303-U | 3mm | \$2.50/ea |
| 24304-U | 4mm | \$2.50/ea |

These fit Diagnostic Scopes only



Welch Allyn Illuminator 3.5V

Featuring the new Halogen HPXTM lamp that provides 30% more light output, for true tissue color and consistent, long-lasting illumination, fiber-optic illumination for cool light and is convertible to a throat illuminator/penlight.



| | | |
|-------|----------------------------------|------------|
| 26530 | Nasal illuminator w/9mm speculum | \$98.20/ea |
| 26535 | Nasal illuminator | \$44.64/ea |

WelchAllyn®

Welch Allyn 3.5v Transilluminator

Featuring a HPXTM lamp, fiber-optic transmission for cool distal light and fully sterilizable. Optional cobalt blue filter.

| | | |
|-------|---|-------------|
| 41100 | Finoff Ocular transilluminator | \$91.07/ea |
| 41101 | Finoff Ocular transilluminator w/Cobalt Blue Filter | \$136.90/ea |
| 41102 | Cobalt Blue Filter | \$32.13/ea |
| 43300 | Curved Transilluminator | \$109.83/ea |

WelchAllyn®



Welch Allyn Halogen Lamp

Lamp bulbs provide a halogen light for true tissue color and consistent, long-lasting illumination.



WelchAllyn®

| | | |
|---------|---|------------|
| 03900 | Fits Scope# 12810 & 11110 | \$22.25/ea |
| 04900 | Fits Scope# 11720, 11730, 11620, 11630 | \$30.02/ea |
| 03000 | Fits Scope# 11710, 11600, & 11610 | \$22.88/ea |
| 03100 | Fits Heads # 25020, 21700, 20200, 20202 | \$21.18/ea |
| 06000-U | Fits Laryn. Handle# 60803 & 60804 | \$22.65/ea |

MED-VET'S SCRUBS DEPOT

(1) 99¢ CLOSEOUT Scrub with every \$10 purchase

CLOSEOUT SCRUBS 99¢/ea

While Supplies Last!



13822 WEST BOULTON BLVD. METTAWA, IL 60045

WWW.SHOPMEDVET.COM

Phone 800-544-7521

283

Fax 800-204-2177

Diagnostic Supplies

Basic & Binocular Microscopes & Accessories



Basic Laboratory Microscope

Premiere Brand

- Real optical glass lenses
- 10x widefield eyepiece
- 3 Achromatic objective lenses 4x, 10x, 40x Power
- Magnification from 40x to 400x
- 90mm x 90mm Stage with clips
- 6 Hold disc diaphragm
- 5 prepared glass slides
- Overall size: 4" x 6" x 11"

MFL-02 Complete Scope kit \$112.00/ea



Ultimate Laboratory Microscope

The same great optics are now even more versatile on a new base with a rechargeable battery light source. The detachable AC power cord can be used to power the light or recharge the battery for portable use "in the field". Battery lasts for hours and can be recharged hundreds of times for years of valuable scientific research!

MFL-05 Complete Scope kit

\$130.00/ea



Binocular Microscope Replacement Bulb

MA13 For MFL-02 \$10.00/ea

Binocular Microscope

Technical Features:

- 30 degree inclined binocular Seidentopf style head, rotatable 360 degree
- Eye piece: 10x wide-field
- 4 DIN objectives: 4x (N.A. 0.10), 10x (N.A. 0.25), 40x (N.A. 0.65), 100x (oil immersion, N.A. 1.25)
- Magnification: 40x to 1600x
- 4 1/2" X 5" (120x125mm) Mechanical stage with coaxial drive/rack and pinion adjustment, left hand controls
- Abbe condenser NA 1.25 with iris diaphragm
- Filter (Blue and Green)
- Coaxial coarse and fine focusing and low knob position
- Built in variable intensity halogen illuminator, 6V 15W
- UL approved 3 wire cord
- Plano-concave mirror (reflector) for ease in outdoor use
- Spare bulb and fuse
- Eye piece pointer for learning aid (optional)
- Size: 6"x8"14 1/2"H, H.W. : 11 lb

MRJ-03 Complete Scope kit \$595.00/ea



Accessories

Binocular Microscope Eye Piece Pointer

MA03 Eyepiece Pointer \$10.00/ea

Binocular Microscope Replacement Bulb

MA07 For MRJ-03 \$10.00/ea

16X Eyepiece for MRJ-03 Binocular Microscope

EYEPIECE 16X Eyepiece \$17.14/ea

Binocular Microscope Fuse

MA01 For MRJ-03 3/Pk \$10.20/pk



Microscopes & Accessories

Deluxe Microscope w/Plan Objectives

A deluxe version of the Revelation III, this microscope has all the same features plus the following upgrades:

- Objectives are plan giving increasing clarity of the image especially on the fringes
- Super-wide eyepiece tube of 30mm provides a huge field of view
- Larger and modern looking frame
- Larger mechanical stage, 160mm x 140mm

JOR334MP \$1,710.00/ea



Binocular LabScope

JOR334MY \$1,495.00/ea

Binocular LabScope w/Plan Objectives

JOR334M2P \$1,450.00/ea

Binocular Microscope

JOR334M5P (10,20,40,50, 100X) Objectives \$1,880.00/ea

M5 Trinoc Labscope

JOR334M5PTL with LED Light \$2,230.00/ea



Binocular Scope w/Phase Turret

10,40,50, & 100X \$2,310.00/ea



Binocular Microscope with Phase Turret

JOR334MPP \$2,500.00/ea



JOR334MPP

Accessories

Microscope Objective 50X Oil

\$359.00/ea

Objection Lens DIN Plan 20x

JOR334MPD20 \$154.00/ea

Hard case for JOR334MP and JOR334MS

Custom Carrying Case for JOR334mp and JOR334ms labscopes. Durable metal construction. Secured with lock, comes with 2 keys.

JOR334MC \$180.00/ea



Eyepiece W/ Pointe (for M series only)

Eyepiece with pointer (JOR334mp series)

JOR334MEP \$81.20/ea

10X Phase Contrast Kit

JOR334PCA \$410.00/ea

40X Phase Contrast Kit

JOR334PCB \$410.00/ea

100X Phase Contrast Kit

JOR334PCC \$410.00/ea

Bulb only

JOR334D1 \$13.50/ea

Infinity LabScope

This new model has a beautiful design with a number of important features.

- Infinity optics usually found only on very expensive microscopes. Best optical system for highest clarity and resolution.
- LED illumination: gives bright almost daylight illumination with very long-lasting bulb, with cool temperature
- 4 semiplan objectives, flat field across 95% of your view
- 10x/20 super wide high-point eyepieces, higher focal point means you can wear glasses and see more of your specimen at each magnification power.
- Ergonomic design
- Can rest your arms and hands flat on the table with all controls in easy reach.
- Optional 50x oil infinity objective
- The highest resolution objective available, which doubles the view of the 100x oil for faster scanning and counting.



JOR334Q \$1,120.00/ea

Infintiy Trinocular LabScope w/Phase Kit

JOR334TIP \$2,489.00/ea

Infinity Binocular Labscope w/Phase Kit

JOR334BIP \$2,390.00/ea

Infinity LabScope Carrying Case

JOR3340C \$199.00/ea

Inspector Zoom Dissecting Microscope

A high resolution stereo zoom microscope, also called a dissecting microscope, with both lower (transmitted) and variable upper (reflected) illumination. Its clean 3D imaging and broad field of view make it perfect for selecting viable embryos. Use the lower transmitted, dim the upper light, and zoom the magnification from 6.5x to 45x to see the structure and condition of each embryo. High magnification options up to 72x or 90x are available. Frosted glass stage with two holding clips.



JOR755 \$1,100.00/ea





Semen Evaluation LabScope

Semen Evaluation LabScope, is perfect for veterinarians interested in live specimen microscopy including: semen evaluation, live biological specimen analysis, and standard brightfield applications. Motility analysis should be performed at 37°C to keep sperm active. The heated stage has a digital temperature control unit permitting temperature settings between 25-50°C and maintains accurate and stable temperatures within +/-0.5° during observation. Unplug the cord from the stage, and the LabScope looks and functions like a standard laboratory-grade microscope. The PLAN phase objectives and turret condenser allow flatfield, high contrast viewing of live, unstained specimens, and easy magnification changes

with the flip of the thumb. Simply turn the turret condenser wheel to switch between brightfield, darkfield, phase 10x, phase 40x, and phase 100x settings. System Features:

- Laboratory binocular microscope
- 10x/20 high-point, oversized WF eyepieces
- Complete semen evaluation system
- X-Y mechanical stage for precise slide movements
- Built-in heated stage with removable cord
- Variable digital temperature control 25-50°C
- Set temperature in 1° increments
- Displays actual temperature in 0.1° increments
- Accurate within 0.5°C
- Reaches temperature with 1-2 minutes
- Switchable power input 110V or 220V AC
- Digital temperature control unit
- 84mm (3.4"W) x 225mm (9")L x 153mm (6.5")H
- 2.5 kg (5.5 lbs.)
- Turret condenser with phase contrast and brightfield
- PLAN flat-field phase contrast - Phase 10x, Phase 20x, phase 40x, phase 100x
- DIN PLAN flat field objectives
- Variable halogen 20 watt Koehler illumination
- Includes blue-green-yellow filters, immersion oil, dust cover & manual
- Microscope specifications
- 200mm (77/8")W x 270mm (105/8")L x 420mm (161/2")H
- 9kg (20 lbs.)
- 110V or 220V AC power
- Lifetime warranty on mechanical and optical components,
- 1-year warranty on electrical components



| | | |
|----------|--|---------------|
| JOR334X | | \$3,989.00/ea |
| JOR334XC | Case for JOR334X | \$199.00/ea |
| JOR334XP | Without heated stage. | \$2,050.00 |
| JOR334XS | Microscope heated stage only | \$1,420.00/ea |
| JOR334XT | Trinocular Head with Camera Connections (optional) | \$4,200.00/ea |

Phase Contrast (option package)

JOR334PC \$1,400.00/pk



Microscope, Portable (w/battery)

JOR334P \$750.00/ea

Phase Contrast Kit

JOR334MPC \$1,080.00/ea

Phase Contrast Kit

JOR334MPC \$1,080.00/ea

Reticle

Reticle for JOR334mp series

JOR334MPD4 \$58.00/ea

M5 LabScope w/Trinocular C-mount Oil Objectives

JOR334M5PT \$2,140.00/ea

Trinocular Head Laboratory Microscope

This is the deluxe microscope with video imaging capabilities. It comes with a C-mount for a variety of camera attachments. It can be used with the JorVet BioVID camera for live video or any standard digital camera for still images.

- Excellent for educating clients, technicians, and sharing information with colleagues.
- Able to capture images without disrupting binocular viewing.

JOR334MPT \$2,250.00/ea

Trinocular Infinity LabScope

JOR334QT \$1,369.00/ea



Trinocular LabScope w/ C-mount

JOR334MX \$2,100.00/ea

Trinocular LabScope w/c-mount phase turret

JOR334M2PTX \$2,500.00/ea

Trinocular Repro

A number of different microscopes can be combined with a camera system. the camera system is then connected to a monitor or computer.

JOR333D Trinocular Semen evaluation Labscope with phase contrast and heated stage with BioVid camera \$4,320.00/ea

Trinocular Scope

JOR334M2PT w/C-mount Objectives, 10,40,50,100X \$1,734.00/ea

Trinocular with Phase Turret

JOR334MPPT \$2,800.00/ea

Trinocular Scope

A number of different microscopes can be combined with a camera system. the camera system is then connected to a monitor or computer.

JOR333B (50 X oil) with Biovid camera \$2,550.00/ea

JOR333C Trinocular Labscope with 10x, 20x, 40x, 50x oil, and 100x oil objectives with BioVid camera \$2,850.00/ea

Trinocular scope w/Biovid camera

A number of different microscopes can be combined with a camera system. The camera system is then connected to a monitor or computer.

JOR333A \$2,380.00/ea





Revelation III Microscope & Pulse Oximeter

Revelation III Microscope

Revelation III Microscope is an improved version of our previous model "Revelation." Excellent for the veterinary in-clinic laboratory. Use for fecal floatation on 10x to cytology on 100x oil immersion. Mechanical stage with coaxial controls (140mm x 140mm) Binocular head with wide field 10x eyepieces Four DIN achromatic objectives: 4x, 10x, 40x, and 100x.

- Moveable ABBE condenser N.A. 125
- 12V 20 watt halogen bulb
- Fine and coarse focus adjustments
- Dust cover
- Inexpensive



| | | |
|-----------|--|-------------|
| JOR334A | Complete | \$795.00/ea |
| JOR334AT | Trinocular head, Optional | \$400.00/ea |
| JOR334AC | Hard Carrying Case for Rev III Microscope. | \$105.00/ea |
| JOR334ACS | Soft Carrying Case for Rev III Microscope. | \$61.00/ea |
| JOR334AD1 | Digital camera adaptor for microscope | \$97.50/ea |
| JOR334AD2 | Reticle for Rev III microscope. | \$69.00/ea |

Revelation 3 microscope with MiniVid RCA

A number of different microscopes can be combined with a camera system. the camera system is then connected to a monitor or computer.

| | |
|---------|---------------|
| JOR333X | \$1,050.00/ea |
|---------|---------------|



Revelation 3 microscope with MiniVid USB

This is the deluxe microscope with video imaging capabilities. It comes with a C-mount for a variety of camera attachments. It can be used with the JorVet BioVID camera for live video or any standard digital camera for still images.

- Excellent for educating clients, technicians, and sharing information with colleagues.
- Able to capture images without disrupting binocular viewing.

| | |
|---------|------------|
| JOR333Y | \$1,185.00 |
|---------|------------|

TonoVet

The use of tonometry to measure Intra Ocular Pressure (IOP) is the only real tool for the screening of glaucoma. Traditional tonometers determine pressure by repeatedly pushing an instrument against the cornea and calculating the force necessary to flatten the cornea. The TonoVet uses a newer technology called "rebound" tonometry. The portable hand held unit is positioned 1/4" away from the cornea. At the push of a button, a tiny probe painlessly and rapidly reaches out and touches the cornea. Six rapid measurements are taken in seconds! The unit is self-calibrating with its own software and it is the size of a cell phone. It has been approved for use on all veterinary patients. It has a limited four year warranty. It runs on 4 AA batteries and has a measurement range of 1-99 mm Hg.

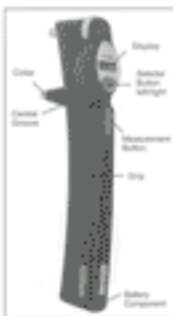

| | | |
|-----------|---|---------------|
| JOR1000 | Complete unit with 100 extra probes and a storage case. | \$3,260.00/ea |
| JOR1000D1 | 100/pack Probes | \$164.00/pk |

Veterinary Pulse Oximeter with Thermistor

Measures oxygen saturation and temperature. Small pulse oximeter with adjustable alarms and LED display that runs continuously. Includes a lingual sensor and rectal sensor with thermistor.

- Intended for continuous pulse oximetry
- Portable with alarms and two LED displays 12-hour NiCad or continuous AC-powered operation
- Adjustable pulse tone levels
- Pitch changes with rise or fall in oxygen saturation
- Adjustable alarm levels for oxygen saturation and pulse rate
- Previous alarm settings are recalled from memory
- Output port for data communication to other instruments. Unit has a five year warranty and sensors each have a 1 year warranty.



| | | |
|------|------------|-------------|
| 340V | Model 340V | \$795.00/ea |
|------|------------|-------------|

Replacement Sensor for Medi-Aid 340V Pulse Oximeter

| | | |
|----------------|--------------------|-------------|
| SENS-MEDIAID-L | Lingual, 9ft Cable | \$160.00/ea |
| SENS-MEDIAID-R | Rectal, 9ft Cable | \$160.00/ea |

Pulse Oximeter Universal Lingual Sensor for Nellcor

| | | |
|--------------|--------------------|-------------|
| CST090-51209 | Lingual, 9ft Cable | \$95.00/ea |
| CST080-51209 | Rectal, 9ft Cable | \$105.00/ea |

Pulse Oximeter Universal Lingual Sensor for Nonin

| | | |
|--------------|--------------------|-------------|
| CST090-51259 | Lingual, 9ft Cable | \$95.00/ea |
| CST080-51259 | Rectal, 9ft Cable | \$105.00/ea |

Pulse Oximeter Universal Lingual Sensor for Surgivet

| | | |
|--------------|--------------------|-------------|
| CST090-51049 | Lingual, 9ft Cable | \$95.00/ea |
| CST080-51049 | Rectal, 9ft Cable | \$105.00/ea |



MEDIAID

Diagnostic Tests



Reagent Strips

High quality test strips at affordable prices. Large Selection of test strip configurations. Easy to read color chart. Uniform read times.

D10 10 Tests, Glucose, Protein, Ketone, pH, Blood, Bilirubin, Urobilinogen, Nitrite, Specific Gravity, Leukocytes 100/Btl \$39.95/ea



Vet-10 Urine Reagent Strips

These urine test strips offer two major advantages:

- Veterinary specific: for urine specific gravity these strips allow values for what veterinary medicine requires
 - Priced at considerable savings over other brands
- These test strips are a high quality grade product made in the USA. The 10 colors on the strip are configured in the same order as the Ames Multistix-10® to avoid confusion and maintain continuity.

The expanded test strip now has the 10th test for leukocytes. 100 test strips per bottle. The strips test for: 1. Nitrite 2. Urobilinogen 3. Protein 4. pH 5. Specific Gravity 6. Ketone 7. Bilirubin 8. Glucose 9. Blood 10. Leukocytes

JOR630X 100/pk \$44.00

JOR630X



Vet-BUN Reagent Strips

These sensitive color-coded test strips use one drop of whole blood to give blood urea nitrogen (BUN) reading. They are a quick and simple screening test for this important blood parameter. Made in the USA.

JOR630Y 25 strips per bottle. \$27.00/ea



Urine Reagent 5

- Tests for:
- Blood
 - Ketone
 - Glucose
 - Protein
 - pH

JOR630W 100 pack \$28.50/ea



JOR893

pH Indicator Paper

JOR892 w/pH range 4-9 \$8.40/ea

pH Indicator Strips

JOR893 w/pH range 5-9 \$17.10/ea



Jorvet Ketone Urine Test Strip

Ketone-Only Test Strip. Screening for ketosis in cattle and sheep.

JOR630K \$10.50/ea

Jorvet Glucose Urine Test Strip

Glucose-Only Test Strip. Suggested for monitoring diabetic cases.

JOR630G 100 pack \$12.00/ea



Fecatector Diagnostic Kit

A unique, sanitary, leak-proof collection device, to be used by the client for obtaining fecal samples from pets. The same container then doubles as the laboratory flotation device. This eliminates the need for technicians to transfer or contact the stool sample. Comes complete with laboratory instructions card and easy-to-follow client instruction sheets. Comes in a compact display box for wall-mounted or counter use.

606-2799 50 kits per box \$17.99/box 6+\$15.99/ea



Zinc Sulfate Fecal Flotation Medium

RX0VA-GAL 1 gallon \$10.99/gal

Fecal-Ova Float Kit

A fecal flotation exam is a necessary part of every routine physical exam as well as many diagnostic workups. Various internal parasite eggs can be detected through this simple test by the use of flotation solutions, which cause the ova to rise to the top of these solutions. Often times, the client is asked to bring a stool sample from home, which is not an easy task in most cases. The fecal ova float is a two-part plastic container for use as both a fecal collection container and a flotation exam container. The inexpensive containers facilitate a simple and hygienic collection of fecal material. Upon arrival at the clinic, the containers will hold the flotation solution, with no spillage, for a flotation exam. Packaged in handy 50-kit dispensing

JOR950 Fecal Ova Float, Dispensing Box with 50 Kits. 7 1/2" x 5 1/2" x 5" \$19.50/ea

Fecal-Ova Float Refill

JOR950B Fecal Ova Float. 50 Kits/Bulk. (dispensing box not included) \$15.90/bx



Con-Trate® Fecal Filters

Contrate fecal filters are especially useful when used in conjunction with swing arm centrifuges for fecal exams. The filter is designed to seat on top of conical test tubes. It is used to filter out particulates and debris from fecal solution after the flotation solution has been mixed with the sample. The contrate fecal filter helps eliminate messy spills and is a good substitute for gauze sponges or tea bag strainers.

JOR952 5/pk. Tray not included. \$12.90/pk

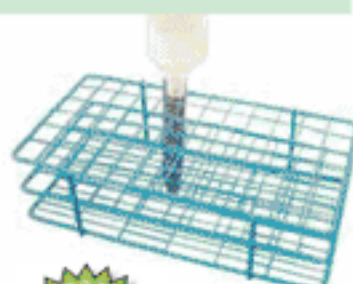

Disposable Polystyrene Tube

Conical shaped tube with graduations.

JOR546A 15ml 100/bx \$12.60/ea



Blood Flow Monitor

Doppler Ultrasonic Blood Flow Monitor

Hypertension (high blood pressure) is often overlooked during diagnosis, treatment and routine physical exams in small animals. In addition, many hypotensive (low blood pressure) patients, such as those suffering from shock, benefit greatly from Doppler measurement of blood pressure when knowing the pressure can mean effective and timely treatment. Combining Doppler with an appropriate size "cuff" for small animals, provides the veterinarian with the same non-invasive method for testing blood pressure as is available in human medicine. A small probe is placed over a peripheral artery, e.g., digital or coccygeal. An ultrasonic crystal in the probe transmits pulse wave sounds back to the amplifier. The pressure cuff is then placed proximal to the probe. The cuff is inflated until the pulse sounds are no longer audible. The cuff is slowly deflated, using the manometer, until pulse sounds are audible once more, at which point the manometer displays a numeric value of the animal's systolic pressure.

Features:

- Lightweight, hand-held unit
- High quality, veterinary-specific "cuff"
- (sphygmomanometer)
- Comes with two cuffs (2.5 cm and 5.0 cm)
- Run on 9-volt battery, included
- Complete with carrying case

JorVet



JOR563 Complete with case \$1,045.00/ea

JOR563



Headset for Doppler

JOR563D8 \$30.00/ea **JorVet**

Doppler Sphygmomanometer

JOR563D3 SPHYGMOMANOMETER ONLY \$126.00/ea

Doppler Cuff

| | | |
|----------|--------|------------|
| JOR563D4 | 2.5cm | \$54.00/ea |
| JOR563D5 | 5.0cm | \$45.00/ea |
| JOR563D6 | 7.5cm | \$45.00/ea |
| JOR563D7 | 10.0cm | \$80.00/ea |

JOR563D

Doppler BP Cuff 1.9cm

Cuff only, 1.9cm.
JOR563D4A \$54.00/ea **JorVet**



Jorvet Disposable Blood Pressure Cuff

These cuffs are made from a soft white vinyl. They feature a Velcro closure and will fit all models of blood pressure measurement systems. A single tube. Made in the USA, and inexpensive. White. 5/pk. Proper Size is 40 percent of the circumference of the limb when the cuff is being applied. These sizes should cover just about all small animals. Cuff size ranges in centimeters.

| | | |
|---------|----------------------|------------|
| JOR563D | 3.5cm W. 9.6-14.3 L. | \$46.50/pk |
| JOR563R | 3.0cm W. 8.5-12.7 L. | \$46.50/pk |
| JOR563S | 2.5cm W. 7.2-10.7 L. | \$46.50/pk |
| JOR563V | One of each size | \$46.50/pk |

JorVet

Microhematocrit Capillary Tubes



These capillary tubes are designed for both safe blood collection as well as an accurate microhematocrit determination. Precision molded, they provide excellent sample retention during centrifugation. Tubes fill rapidly without affecting specimen integrity. Tube 1.15mm i.d. x 1.55mm o.d. 75mm length. Packaged in a protective snap cap vial. 100 tubes/vial/10 vials/cs

JOR543 Red Tip, Heparinized Tube, 100/vial \$33.00/cs

JorVet

Jorvet Capillary Sealant Tray

Leak-tight sealant formed quickly from unique compound designed to withstand centrifugation. Non-toxic, non-drying, non-hardening.

JOR545 Tip resistant tray for upright storage of 24 tubes. \$6.30/ea

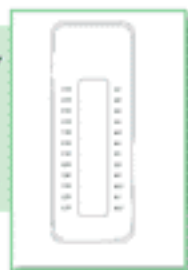

Alkaline Battery

| | | |
|--------|---------------|-----------|
| BAT-AA | Size AA 24/Bx | \$7.95/bx |
| BAT-C | Size C 6/Pkg | \$1.99/pk |

Microhematocrit Reader Card

A laminated chart necessary for determining PCV values from hematocrit tubes. (not pictured)

JOR501RC \$15.00/ea

JorVet

Clinical Refractometer

A high-quality clinical hand-held refractometer for quick and accurate urine specific gravity plus serum total protein measurements. Adjustable focus. Comes with protective case.

JOR351 7" With Case

\$195.00/ea





Intelect® Transport Ultrasound **Jorvet**

Therapeutic ultrasound provides deep tissue-heating to treat musculoskeletal injuries, as opposed to superficial heat treatment. Ultrasound also delivers non-thermal pulse down effects. The combination of deep heating and non-thermal effects makes this a unique and versatile therapy. This unit is transportable featuring logical control system; a large easy-to-read graphical LCD display, and user defined protocols. **FEATURES:** Ergonomically designed applicators, 10cm² head size for equine patients, fully functional 1 and 3.3MHz frequencies, pulsed and continuous therapy, head warming function on applicators, two year warranty on unit, 90 days on sound heads.

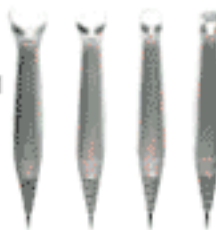

JOR1015ED1 10cm Ultrasound applicator head

\$342.00/ea

Jorvet Optivisor®

Jorvet

Optivisor is a precision binocular headband magnifier which permits unrestricted user efficiency—leaving both hands free, while reducing eye strain—allowing three dimensional vision. It can be worn over prescription eyeglasses. Equipped with these unique features:

- Optical glass prismatic lenses. Ground and polished to precision optical standards.
- Bevel edged and mounted in interchangeable plastic frame.
- Adjustable pivots allow the visor to be tilted out of the way when not in use, and at your fingertips when magnification is needed.
- Adjustable headband conforms to fit all head sizes. Fabricated from a special blend of lightweight material. Comfortable when worn for long periods of time.
- High impact visor is tough, durable, and always new in appearance.
- Genuine leather comfort band is padded with orthopedic felt to add comfort.
- Magnifies 2.5 times at 8".
- Optivisor is perfect for eye exams, (i.e. corneal foreign body, distichiasis). Varying magnifications and focal lengths available:

| | | |
|---------|----------------|------------|
| JOR801 | 2 1/2 X at 8" | \$63.00/ea |
| JOR801B | 1 3/4 X at 14" | \$63.00/ea |
| JOR801C | 2 X at 10" | \$63.00/ea |
| JOR801D | 2.75 X at 6" | \$63.00/ea |
| JOR801E | 3.50 X at 4" | \$63.00/ea |

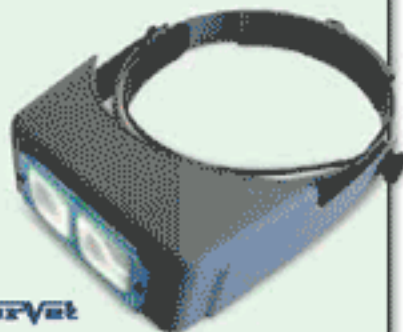

Jorvet Optiloupe®

Jorvet

- An attachable lens that adds the additional power of an eye loupe to the Optivisor.
- Designed for monocular use and easily flips up or down providing additional 2 1/2 X magnification.
- Easily attached to either eye of Optivisor.

| | | |
|---------|-----------------------|------------|
| JOR801L | 2 1/2 X magnification | \$14.40/ea |
|---------|-----------------------|------------|

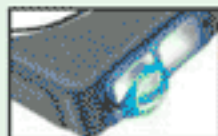

Replacement Lens Plate

Only for optivisor. These lenses interchange by removing two screws.

Jorvet

| | | |
|-----------|--------------------------------------|------------|
| JOR801LPA | 1.5 Magnification, 20" Focal Length | \$44.40/ea |
| JOR801LPB | 1.75 Magnification, 14" Focal Length | \$44.40/ea |
| JOR801LPC | 2 Magnification, 10" Focal Length | \$44.40/ea |
| JOR801LPD | 2.5 Magnification, 8" Focal Length | \$44.40/ea |
| JOR801LPE | 2.75 Magnification, 6" Focal Length | \$44.40/ea |
| JOR801LPF | 3.5 Magnification, 4" Focal Length | \$41.40/ea |

Ultrasound Gel

An aqueous coupling medium for diagnostic and electrical/medical procedures.

TRANS-GEL5L 5 Liter w/ 9 oz dispenser bottle \$24.99/ea

Ultrasound gel

An aqueous coupling gel for both diagnostic and therapeutic procedures (i.e., ultrasound or doppler).

| | | |
|----------|--------------|------------|
| UGEL-8OZ | 8oz Ea | \$3.99/ea |
| JOR554 | 8 oz. bottle | \$5.10/ea |
| JOR554B | 5 liter bulk | \$27.00/ea |



Head Magnifier

Head Lighted Multi-Power Head Magnifier includes:

- Both side light attachment (4 AAA batteries, not included).
- Light weight, approx: 1/4lbs.
- Coated acrylic lens.
- Easy self-locking adjustable head strap with swivel head.
- Wide body, can be used while wearing reading glasses.
- Multiple magnification from: 2.2x to 4.8x with 3 lens/loupe, fixed lens, flip lens 1.1x, loupe 1.5x.
- Clean with soft lint free cloth with natural cleaning agent.

Head Magnifier Multi-Power (Loupe) includes:

- Light weight, approx: 1/4lbs.
- Coated acrylic lens.
- Easy self-locking adjustable head strap w/swivel head.
- Wide body, can be used while wearing reading glasses.
- Multiple magnification, from: 2x to 4.8x with 3 lens loupe, fixed lens 2.2, flip lens 1.1x, loupe 1.5x.
- Clean with soft lint-free cloth with natural cleaning agent.

| | | |
|---------|----------------------------|------------|
| MH1042C | Head Magnifier-not lighted | \$29.95/ea |
| MH1043C | Head Magnifier- Lighted | \$34.95/ea |



Visor Head Light

Provides hands-free light where you need it. Pack mounted on head band. Xenon laser beam emits 6000 candle power. Operates ~5-6 hours with 2 AA batteries.

JOR801V Head Light \$38.00/ea

Visor Light Replacement Bulb

JOR801VD1 2 pack \$19.20/1pk



Visor Sold Separately

Centrifuge Tube

Conical shaped tube with graduations.

Jorvet

JOR546A Disposable Polystyrene Tube. 15ml. 100/box \$12.60/ea



Ultraviolet Light

- Special fluorescent bulbs produce UVA at approximately 360 nm wavelength.
- Available with magnifier and white bulbs.
- 4-light magnifier models include optically ground and polished glass 5 diopter magnifier lens with 2.25X total power magnification and focal length of 8".
- 6,000 hour average bulb life.
- 5-year warranty. Made in the USA.

UV503 U.V Woods Light \$485.00/ea



Woods Light

UV59B Bulb \$13.00/ea
 UV59 Light w/bulb \$63.00/ea



Replacement Bulb for Portable Woods Light.
 JOR312B Replacement Bulb for Portable Woods Light. \$17.10/ea

Disposable Pen Light

Lightweight penlight for a variety of hospital uses. Selected pinpoint bulbs for high intensity. Clips easily onto your pocket.

JOR315 6/pk. \$18.60/pk



Halogen Penlight

The JorVet Penlight with halogen bulb offers 400 percent more candle power than standard penlights.

JOR114BH Uses two "AA" batteries, included. \$33.00/ea



Jorvet Ultraviolet Wood's Light 220v

- A hand-held lamp with 220V plug-in. High impact plastic housing.
- Ultraviolet light at wavelength of 365nm with intensity of 180uW/cm² at 6"
- 7 5/8" x 2 7/8" x 2". 1 lb.
- 4-watts

JOR312QF 4 watt, 220-volt \$148.00/ea
 JOR312SF 6 watt, 220V \$197.00/ea



Jorvet Ultraviolet Wood's Light 110v

- A hand-held lamp with 110V plug-in. High impact plastic housing.
- Ultraviolet light at wavelength of 365nm with intensity of 180uW/cm² at 6"
- 7 5/8" x 2 7/8" x 2". 1 lb.
- 4-watts

JOR312Q 4 watt, 110V AC \$148.00/ea
 JOR312QB Replacement bulb for 4 watt light \$36.40/ea



Ultraviolet Wood's Light

- Uses 110V plug-in.
- Ultraviolet light at wavelength of 365nm
- 14 9/10" x 3 9/10" x 2 1/2". 2 lbs.
- 6-watts

JOR312S 6 watt, 110V AC \$197.00/ea
 JOR312SB For 6 watt light Bulb Only \$37.20/ea



Jorvet White Slit Light



Designed with a high intensity white slit for cataract evaluation, checking the anterior chamber or for corneal edema.

JOR314A AA batteries included. \$51.00/ea



Disposable Pen Light

Lightweight penlight for a variety of hospital uses. Selected pinpoint bulbs for high intensity. Clips easily onto your pocket.

JOR315 6/pk. \$18.60/pk

Halogen Penlight

The JorVet Penlight with halogen bulb offers 400 percent more candle power than standard penlights.

JOR114BH Uses two "AA" batteries, included. \$33.00/ea

Jorvet Endolight

New and improved, this small penlight has an attached flexible metal rod with a small wheat-head-size bulb. A small endotracheal tube 5mm easily slides over the rod. Gives rigidity and great illumination when intubating small dogs and cats. Makes a small keyhole task simple.

JOR167Q Operates on "AA" batteries (included). 10" shaft. \$22.50/ea
 JOR167QD1 Bulb only \$10.80/ea



Scales

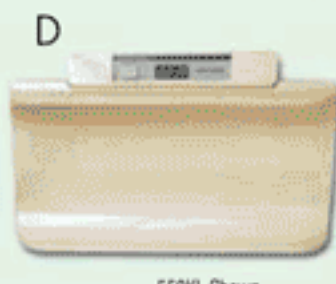

Portable Pediatric Scale (A)

Accurate weights of your smaller patients are important. Small changes in weight can indicate disease. An accurate weight is also important for proper dosing of medication plus your clients like to know their animal's weight. Tray dimension: 10 1/2" x 21 1/2". Scale dimensions: 10 1/2" x 11 1/2"

- Accurate, instant and easy-to-read LED display, 4 digits 1/2" high
- Lock-in weight with zero/tare function
- Automatic power off function
- 44 lbs. (20 kg) capacity
- Graduation: 0-20 lbs. x 1 oz. (0-10kg x 20g); 20-44 lbs x 2 oz. (10-20kg x 50g)
- Uses 4 AAA batteries (included)

JOR825 Portable, 5.5lb \$169.00/ea

Portable Mechanical Pediatric Scale

The Health O Meter 386S-01 portable mechanical pediatric scale is well suited to the medical environment. The sanitary tray provides maximum safety, and the poise beam is easy to read. This scale reads in lbs. Drop ship charges may apply

386S01 Standard Weight, 50 lb. Cap. \$149.00/ea
386G501 Metric Weight, 26 kg. Cap. \$149.00/ea

Portable Pet Scale (C)

Easy Read® LCD display with weight hold and auto shut-off after 5 minutes. 7" x 8 5/8" stainless steel platform. 6 lb. capacity. Includes rechargeable battery (50 hour in use) and 120V AC adapter/recharger. One year limited warranty.

FS6 7" X 8 5/8", 6lb capacity \$396.00/ea

Electronic Pet Scale (D)

Lightweight heavy-duty scale with a low profile base makes it an ideal choice for small animal practice. Features auto zero, auto weight lock, auto shut-off after 3 minutes and low battery indicator. Easily removed and cleaned 21" x 12 1/2" x 4 3/4" tray. Engineered for optimum accuracy and repeatability of weights. 44 lb. capacity. Uses a 9 volt battery (not included). One year warranty.

550KL 44lb capacity \$654.00/ea
522KL Digital Pediatric Tray Scale, 50 lb. capacity \$352.00/ea
553KL Digital Pediatric Scale, 44 lb. weight capacity \$311.00/ea
597KL Digital Physicians Scale W/ Measuring Rod, 600 lb. capacity \$622.00/ea

Elite Floor Standing Electronic Scale (E)

Elite Floor-Standing Lateral, Regal 300 Electronic Scale Lift Table

12661-01-GZLWEF Elite Floor-Standing Lateral, Regal 300 Electronic Scale Lift Table \$3,650.00/ea

Electronic Pro Series Veterinary Scale (F)

Designed for time-saving, convenient operation. Has remote electronic control indicator with bright, easy-to-read LED display, auto zero, push-button tare and weight lock-in with pound/kilo readings. A significant breakthrough in sensitivity and exacting accuracy compensates for animal movement. Quality construction for long-term dependability. Rugged stainless steel 42" x 22" x 1.5" platform. Includes rechargeable battery, 120V AC adapter/recharger and removable grey mat for easy cleaning. Full two year warranty, full one year warranty on battery.

2842KL Pro Series, 600lb capacity \$1,157.00/ea



Hanging Scale

This durable scale has a steel body, powder coated for extra durability. It has two sturdy 4" steel hooks (one on top and one on bottom). This hanging mechanical scale has a 220 pound / 100 kilogram capacity with 2 pound / 1 kilogram resolution. Drop ship charges may apply **Not Shown**

7820-000-000 Hanging Scale, capacity 220 lbs. \$46.00/ea



WWW.SHOPMEDVET.COM

13822 WEST BOULTON BLVD. METTAWA, IL 60045

WWW.SHOPMEDVET.COM

Phone 800-544-7521

292

Fax 800-204-2177



Physicians Balance Beam Scale (G)

The 402KL Physician Beam Scale offers an astonishing 500 lb (200 kg) capacity with 1/4 lb (100 g) graduation when used with the included additional counter weights. The 402KL scale reads in either pounds or kilograms, just rotate the easy to read poise bars with a twist of the wrist. The poise bars have permanent, engraved numerals, and are powder coated inside and out for long life. The heavy duty 10 1/2" by 14" steel platform is strong and durable with ample foot room and an ABS plastic platform cover for easy cleaning. The 402KL Physician Balance Beam Scale also features a professional dual read height rod for monitoring growth. The smoothly operational height rod measures in 1/8" (1 mm) increments and has a measuring range of 23 5/8" (60 cm) to 84" (213 cm). This fine scale comes to you factory calibrated to ensure accuracy. And now with an incredible new 10 Year Warranty! Drop ship charges may apply.

402KL Physicians Balance Beam Scale W/ Height Measuring Rod, 500 lb. capacity \$244.00/ea

Portable Digital Baby Scale (H)

The Health-O-Meter 549KL Digital Baby Scale has an easy to clean sanitary tray and a 44 pound maximum capacity. The 549KL operates on one 9 volt battery. Other features include a 2 minute auto-off function and a 2 minute auto-hold to display the weight after the baby has been removed from the scale. Drop ship charges may apply

549KL Portable Digital Baby Scale, 44 lb. weight capacity \$197.00/ea

Jorvet Cardiofax ECG

Cardiofax GEM ECG-9020K is a multi-channel interpretive electrocardiograph which incorporates a large waveform display and recorder in a compact and lightweight package.

- Features:
- Large LCD
- Special ECG analysis program
- Operable with AC and Battery Power
- Easy Operation
- Paper saving recording
- Compact body



JOR851 ECG Unit \$3,390.00/ea

Jorvet Cardiofax Paper

JOR851-D 100 sheets, 20 printouts. \$17.60/1

Televet ECG Electrodes

JOR1002D1 \$21.60/ea

Dura Stick II Electrodes

JOR1014D3 1 1/4" round \$96.00

JOR1014D4 2 3/4" round \$96.00



ECG Machine

The ECG is one of the most under utilized diagnostic parameters in veterinary medicine. An ECG is an absolute necessity for proper cardiac diagnostics. The Jorvet Single Channel ECG and monitor offers what veterinarians need at a very reasonable price. The all-important lead II rhythm strip can be run for screening purposes; and if further evaluation is deemed necessary, all 6 common leads can be run for more thorough diagnostics.

Features and Benefits:

- One touch keypad buttons allow for easy set up and operation
- Large screen is well lit and easy to read
- Single channel displays and prints one lead at a time
- Features both MANUAL and AUTO modes
- Dimensions are 12"L x 8 7/8"W x 2 5/8"H
- Weighs just 6.25 lbs
- Operates on either AC or 12 volt NiMH rechargeable battery
- Patient comfortable electrode clips
- Built in paper printer
- Supports patient monitoring via onscreen tracing, i.e., lead II
- Supports diagnostic evaluation via the printed tracing
- 3 year warranty on the ECG unit, 1 year on battery and leads

JOR1010 12"L x 8 7/8"W x 2 5/8"H \$1,080.00/ea



ECG Paper Rolls

JOR1010D3 Extra (each) \$4.50/ea



Schiotz Tonometer

The most economical method for measuring ocular pressure. Kit comes complete with conversion chart and storage case.

JOR506 German-made.

\$210.00/ea

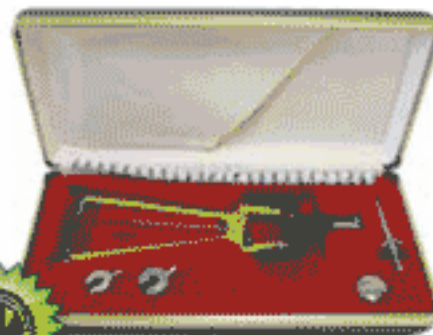

Vet Tech Kit

Included in the soft side zipper pouch:

- 1 Stethoscope
- 2 Pen Lights
- 1 2-130
- 1 2-145
- 1 4-510
- 1 4-511
- 1 Nye Model Tourniquet

VETTECHKIT 8 piece \$29.95/ea





Biocam 2.0 -

Biocam 2.0 Video Otoscope

- JOR1100 Video Otoscope Includes \$650.00/ea
Includes software
- 3 interchangeable speculums
 - 4 speculums with working operating channel
 - Optical Format 1/4.5 inch VGA CMOS
 - Sensor Resolution 660H X 507V, 334,620 pixel
 - Effective Pixels 640H x 480V, 307,200 pixel
 - Camera Function Live & capture, record, focus
 - Sensor Pixel Size 3.6 m x 3.6 m
 - One Year Limited Warranty on Parts & Labor.



The New Revolution in clinical diagnosis

Biocam 2.0 Accessories

Disposable Speculum

- | | | |
|------------|-----------------------------|------------|
| JOR1100D12 | Small, 3mm x 32mm, 50/pk | \$34.50/bx |
| JOR1100D13 | Medium, 4.6mm x 45mm, 50/bx | \$34.50/bx |
| JOR1100D14 | Large, 5.2mm x 52mm, 50/bx | \$34.50/bx |

INTERCHANGEABLE SPECULUM



FOCUS DIAL



FREEZE BUTTON



USB PORT

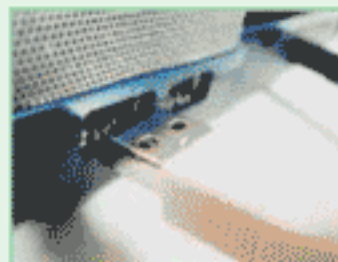

The portability and high-resolution imaging and video recording make clinical diagnosis simple and practical. It educates the client in understanding the process resulting in increased compliance. This one of a kind video otoscope has multi-use capabilities in one device. Designed with precision and cutting edge technology. Features:

- **Portable.** This device can be plugged into any Microsoft platform computer with a USB2.0 port.
 - **Power.** No batteries or external power source is needed. It is powered through the USB port.
 - **Light Source.** 6 LED bulbs allow 10,000 working hours.
 - **High Resolution Imaging and Video Capture.** The Bio-Cam 2.0™ with a quad VGA of 1280H x 960V, 15fps creates sharp and accurate imaging for easy diagnosis. The BioCam 2.0™ also records real-time video through live capture.
 - **Multi Usage.** With its live capture, easy one-touch record and focus functions, the BioCam 2.0™ allows before and after imaging. It is capable of being used for multiple diagnosis as in skin lesions, dental tartar, ear infections and more.
 - **Interchangeable Speculum.** Interchangeable disposable speculums offer medical professionals more flexibility for diagnosing. The portability and high-resolution imaging and video recording make clinical diagnosis simple and practical. It educates the client in understanding the process resulting in increased compliance. This one of a kind video otoscope has multi-use capabilities in one device. Designed with precision and cutting edge technology. Features:
 - **Portable.** This device can be plugged into any Microsoft platform computer with a USB2.0 port.
 - **Power.** No batteries or external power source is needed. It is powered through the USB port.
 - **Light Source.** 6 LED bulbs allow 10,000 working hours.
 - **High Resolution Imaging and Video Capture.** The Bio-Cam 2.0™ with a quad VGA of 1280H x 960V, 15fps creates sharp and accurate imaging for easy diagnosis. The BioCam 2.0™ also records real-time video through live capture.
 - **Multi Usage.** With its live capture, easy one-touch record and focus functions, the BioCam 2.0™ allows before and after imaging. It is capable of being used for multiple diagnosis as in skin lesions, dental tartar, ear infections and more.
- Interchangeable Speculum. Interchangeable disposable speculums offer medical professionals more flexibility for diagnosing.*



Respirator/Alarm & Vagiscopes

Vet-Alarm Respiratory Monitor **JorVet**

This respiratory monitor is a simple yet reliable indicator of apnea. The sensor is placed in the breath pathway and detects each breath. If a breath does not take place in a selected time interval an alarm will sound. A flashing liquid crystal screen shows the last time a breath was detected. 2" x 5" x 5".

- Small, 1 1/2 lbs.
- Rechargeable battery
- Mounting bracket

JOR166M 2" x 5" x 5" \$495.00/ea



Vet-Alarm Respiratory Monitor Accessories

JOR166MD1A Sensor Wire with Connector \$48.00/ea
 JOR166MD2 Rechargeable battery \$36.00/ea
 JOR166MD3 AC adaptor recharger \$24.00/ea



Jorvet Breathe Safe Respiration Monitor

This tiny—smaller than a cigarette pack—monitor makes a great apnea alert monitor. The small microprocessor beeps with every breath with a very high sensitivity.

- Easy to use: just connect between endotracheal tube and anesthesia circuit
- No adjustments: a sophisticated algorithm recognizes and indicates every breath with a beep, working from a 1 lb. kitten to a 200 lb. St. Bernard.
- Apnea alert: a distinctive alert sounds if patient fails to breathe for 45 seconds
- Auto shut-off
- A high density long-life lithium battery provides years of service
- One-year warranty

JOR166RM 1/2"W x 2 1/4"L x 1 1/2"D. 3oz \$200.00/ea

JorVet



Canine Vaginoscope

Can also be used as a proctoscope.

JOR1140M Medium 6" x 5/8" \$14.40/ea
 JOR1140S Small 6" x 1/2" \$14.40/ea
 JOR1140L Large 6" x 3/4" \$14.40/ea



JorVet

Large Animal Vaginoscope

Equine and heifers. Autoclavable.

JOR114H 1 1/2" I.D. x 18" \$18.90/ea
 JOR114I 2" I.D. x 18" \$22.20/ea



JorVet

Llama Vaginoscope

JOR114L 1" I.D. x 12" \$18.00/ea



Vaginal Speculum

Exterior surface is silicon-coated and one end is rolled smooth for ease of insertion. The interior surface is lined with aluminum foil for optimum light reflection. Individually wrapped. Disposable

JOR271 Sterile, 11.4" dia. 18"L 50/pk \$99.50/pk

JorVet

Bovine Heavy-Duty Laryngoscope

Withstands chewing. Autoclavable.

JOR114J 11 1/2" x 18" \$21.00/ea

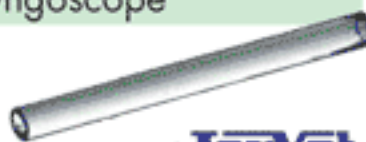

JorVet

Canine Gastroscope

Excellent for visualizing the upper GI. Large. Not autoclavable.

JOR114NL Large 18" x 5/8" \$14.40/ea
 JOR114NS Small 18" x 1/2" \$14.40/ea



JorVet

Light Conducting Rod with Clip

JOR114KM (Clip/light shown attached to scope) \$7.50/ea

Not autoclavable.



JorVet

Check Out Our Anesthesia Section for a full selection of products



13822 WEST BOULTON BLVD. METTAWA, IL 60045

WWW.SHOPMEDVET.COM

Phone 800-544-7521

295

Fax 800-204-2177



Petchek Heartworm PF Antigen Test
 RXPETCHEK-D 192 tests/box
\$510⁰⁰/bx

Schirmer Tear Test
 RXSCHIRMERS0 50 strips per box
\$58⁸⁹/bx

Witness Heartworm Antigen Test
 RXWITHW-25 25 tests/box
\$145⁰⁰/bx

Witness FelV Test Kit
 RXWITFELV-10 10 tests/kit
\$107⁶⁶/pk

Witness Parvo Test
 RXWITPARVO-10 10 tests/box
\$235⁰⁰/bx

Dermatophyte Test Medium
 RXDTM-CULTURE 10 cultures/box
\$154⁰⁰/bx

No returns on pharmaceuticals • Prices subject to change without notice.
 Shipping charges for refrigerated items are a flat charge based on UPS Zone.
 Customer accepts full responsibility for condition of products upon receipt.

Idexx Snap Test
 RXCOMBO-150 FelV Ag/FV Ab Combo, 15 tests/box \$447.00/bx
 RXCOMBO-300 FelV Ag/FV Ab Combo, 30 tests/box \$699.00/bx

RXGIAR-150 Giardia, 15 tests/box
\$199⁰⁰/bx

RXPARVO-5D Parvo Antigen, 5 tests/box
\$103⁰⁰/bx

RXFELV-150 FELV Antigen Test, 15 tests/box \$265.00/bx

RXFELV-300 FELV Antigen Test, 30 tests/box \$395.00/bx

RXHEART-150 Heartworm Antigen, 15 tests/box \$199.00/bx

RXHEART-300 Heartworm Antigen, 30 tests/box \$321.75/bx

RXDEX-3DX-30 3DX for heartworm, ehrlichia, lyme, 30 tests/box
\$519⁹⁹/bx

Idexx Test

| | | |
|-----------|---|-------------|
| RXDEXALP | Alkaline Phosphatase 25 tests/box | \$130.00/bx |
| RXDEXAMYL | Amylase 25 tests/box | \$130.00/bx |
| RXDEXBUN | BUN 25 tests/box | \$130.00/bx |
| RXDEXCRE | Creatinine 25 tests/box | \$130.00/bx |
| RXDEXGHP | General Health Profile (GHP), 12 chem/profile, 2 profiles/box | \$65.00/bx |
| RXDEXLIP | Lipase 25 tests/box | \$130.00/bx |
| RXDEXPAP | Pre-Anesthetic Profile (PAP), 6 chem/panel, 4 panels/box | \$93.00/bx |
| RXDEXALT | ALT 25 tests/box | \$130.00/bx |

Jorvet Surgicutt Bleeding Time Devices

A simple automatic incision making handheld device for determining bleeding time i.e. buccal mucosal bleeding time. White color. 1 mm depth blade for large dogs. Single use product.

JOR522S Adult \$6.60/ea
 JOR522J 1" x 1" x 3/8", Surgicutt Junior \$6.60/ea
 JOR522P Surgicutt blotting paper \$18.75/ea



Handy Tech Pet Parking System **Jorvet**

The new "hands free" secure pet parking system secures a dog safely in one quick and simple move. It is useful for both clients and clinic staff. The system can be mounted just about anywhere. Useful near or at the reception desk, in exam or treatment rooms. Spiral shaped with no sharp hooks. Epoxy-coated stainless steel. Two mounting screws with anchors provided. 4/box.

| | | |
|---------|--|------------|
| JOR762B | Blue, 2 3/4"W x 2 1/2"H x 2 1/2"D | \$12.90/pk |
| JOR762G | Gray, 2 3/4"W x 2 1/2"H x 2 1/2"D | \$12.90/pk |
| JOR762R | Red, 2 3/4"W x 2 1/2"H x 2 1/2"D | \$12.90/pk |
| JOR762Y | Yellow, 2 3/4"W x 2 1/2"H x 2 1/2"D | \$12.90/pk |
| JOR762 | Set of all 4 colors, 2 3/4"W x 2 1/2"H x 2 1/2"D | \$48.00/pk |



Hemo Nate Blood Filtration System

Removes small volumes of particulate debris through an 18 micron stainless steel filter which allows viable blood product to pass through with ease. Especially useful with "syringe" method of transfusion used in feline medicine.

JOR522H Attaches to any male fitting. \$6.60/ea

Hemo Tap Filter Spike

This spike has a filter and can be used on any blood bag or transfer component bag. Used for adding blood compatible medications or syringe access.

JOR522T \$4.80/ea





Thermometers

Digital Thermometer

Features a variety of high-tech innovations that make it ideal for veterinarians and technicians. It provides accurate temperatures at a fast pace. The portable lightweight high quality thermometer offers a wide temperature range: -40deg to 400deg F (-40deg to 150degC) with 0.10F resolution and a system accuracy of +0.210F or + 0.2% of readings.

Features:

- Operations status (F or C) is indicated on the display.
- Detachable fast-acting probe can be stored in a durable case when not in use.
- 3 1/2"L with reinforced connection. Final temperature readout within 60 seconds.
- Warranty: 1 year on unit, 90 days on probe.

| | | |
|----------|-------------------------|-------------|
| JOR285B | Battery Unit with probe | \$269.00/ea |
| JOR285EC | Extension cord, 10 ft. | \$47.00/ea |
| JOR285P | Probe only | \$79.00/ea |

Quick Read Handheld Digital Thermometer

This thermometer gives a quick reading with an audible beep. The special design is a very ergonomic hand-held angle that works well for all animals large and small. Uses two AAA batteries (included). You can select either Fahrenheit or Celsius. Automatically shuts off if not in use.

| | | |
|--------|--------------------------|------------|
| JOR188 | Reading in 10-60 seconds | \$30.00/ea |
|--------|--------------------------|------------|



Audible Digital Thermometer

Features a variety of high-tech innovations that make it ideal for veterinarians and technicians. It provides accurate temperatures at a fast pace. Features: The portable lightweight high quality thermometer offers a wide temperature range of -40° to 400°F (-40° to 150°C) with 0.1°F resolution and a system of accuracy of +0.21°F or +0.2% of readings. Operations status (F or C) is indicated on the display. The detachable fast-acting probe can be stored in a durable case when not in use. 3 1/2"L with reinforced connection. Final temperature readout within 60 seconds.

| | | |
|---------|--|-----------|
| JOR134A | 5"L. Available with or without a case. | \$5.60/ea |
|---------|--|-----------|



Probe Covers

NOTE: Not recommended for use in large animals.

| | | |
|----------|------------------|------------|
| JOR134AC | Sterile, 100 pk. | \$10.50/ea |
|----------|------------------|------------|



Jorvet Plastic Thermometer Case

Heavyduty plastic, will hold large animal thermometer (sold separately) has clip for shirt/jacket pockets.

| | | |
|---------|-----|-----------|
| JOR187F | 5"L | \$1.20/ea |
|---------|-----|-----------|



Jorvet Digital Thermometer Flexible Tip

More patient-friendly than the standard rigid thermometer. Reads fahrenheit scale and has an audible beep when ready.

| | | |
|---------|------------------|-----------|
| JOR134F | Battery operated | \$6.00/ea |
|---------|------------------|-----------|



Fecal Loop

Inexpensive plastic loop with slotted ends for quick and easy fecal samples. Reusable. This can easily be inserted into the rectum and a small amount of fecal material trapped in the loop. Can be cleaned, disinfected, and used repeatedly. Two convenient sizes available.

| | | |
|---------|------------------------------------|-----------|
| JOR147 | Standard size. 9" x 3/8" | \$2.55/ea |
| JOR147P | Puppy & Kitten size. 4 3/4" x 1/4" | \$2.55/ea |



Anti Kick Device

Bron screw down model for use on Achilles Tendon.

| | | |
|-------|------------|------------|
| JOR66 | Bovine Use | \$78.00/ea |
|-------|------------|------------|



Anti-kick Bar

| | | |
|--------|------------|------------|
| JOR66B | Bovine Use | \$21.00/ea |
|--------|------------|------------|



Aspir-Gun

12cc. The Aspir-gun is combined with a 12cc syringe for precise fine needle aspiration biopsy. It can be used on any nodule that can be palpated or visualized with X-ray or ultrasound. It is especially useful for superficial lumps, allowing one hand to remain free to immobilize the lesion. Autoclavable.

| | | |
|--------|-----|------------|
| JOR645 | 6"L | \$70.00/ea |
|--------|-----|------------|



Michele Trephine

Perfect instrument for a bone biopsy or drilling a small hole into the sinus. 6mm head. German-made. Stainless steel. Autoclavable.

| | | |
|--------|---------------------------------|----------|
| JOR229 | German, Stainless steel, 7 1/2" | \$113.00 |
|--------|---------------------------------|----------|



Jorvet Foreign Body Retriever

For small animals. This instrument can be inserted into gastroscop to grasp any lodged foreign body.

| | | |
|--------|-----|---------|
| JOR103 | 24" | \$27.00 |
|--------|-----|---------|

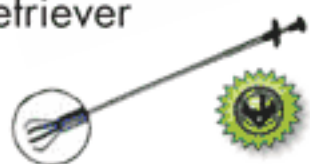

Anesthesia Products

Anesthesia Units



Accessories

Encased Flowmeter .2-4 LPM

JOR559D6 \$239.00/ea

Pop-off Valve

JOR559D7 \$162.00/ea

Table top base only

JOR559TB \$330.00/ea

Mobile Anesthesia Unit

Small Animal Lexus Anesthesia System. Performance for a high standard of care with economy of initial investment. Precise machined fittings for an airtight connection. Powder coat finish is attractive and easy to clean. Protected, enclosed flowmeter with 200cc to 4 lpm setting. Integrated O2 flush valve set at 15 lpm. Soda lime canister is protected by its location under block. Smaller size, 970cc, versus standard 1300cc. Also quick turn knob for each change of exhausted soda lime. Pop-off valve attaches to a standard scavenger unit. Manometer pressure gauge for proper bagging of animal.

- Includes two anesthesia circuits, one universal "F" circuit and one non-breathing circuit.
- Available in mobile and table top models.
- Will accept most vaporizers.
- Available with Tech II or Tech IV vaporizer.

| Item# | Details | Price |
|---------|--|---------------|
| JOR559 | Mobile Unit without Vaporizer | \$1,998.00/ea |
| JOR559A | Mobile Unit With Vaporizer | \$2,868.00/ea |
| JOR559B | with Refurbished Drager Isoflurane Vaporizer | \$2,868.00/ea |
| JOR559Z | Anesthesia Machine w/ Tech V Vaporizer | \$2,868.00/ea |

Manometer

JOR559D8 \$49.00/ea

Storage Shelf for Anesthesia Machine

JOR559S \$108.00/ea

Wall Mount Anesthesia Units

JorVet

| | | |
|-----------|-----------------------|---------------|
| JOR559W | w/o Vaporizer | \$1,430.00/ea |
| JOR559WB | with Drager Vaporizer | \$2,250.00/ea |
| JOR559WC | w/Tech V Vaporizer | \$2,230.00/ea |
| JOR559WSA | w/Tech III Style | \$2,370.00/ea |

Rodent Anesthesia Machine

JorVet

| | | |
|----------|---|---------------|
| JOR559R | w/Isoflurane Vaporizer, without CO2\$1,995.00/ea absorber | |
| JOR559RW | Wall Mount No Vaporizer w/o CO2 | \$1,300.00/ea |

Wall Mount Anesthesia Machine w/Arm

| | | |
|-----------|--------------------------------------|---------------|
| JOR559WS | w/Arm & No vaporizer | \$1,664.00/ea |
| JOR559WSC | w/Arm & Tech V vaporizer | \$2,500.00/ea |
| JOR559WSB | w/Arm & Refurbished Drager Vaporizer | \$2,470.00/ea |

Retractable Lift Assisted Anesthesia Machine

| | | |
|----------|----------------------|---------------|
| JOR559Y | w/o Vaporizer | \$2,636.00/ea |
| JOR559X | w/ Tech IV Vaporizer | \$3,195.00/ea |
| JOR559X3 | w/Tech II Vaporizer | \$3,990.00/ea |

Table Top Anesthesia Unit

| | | |
|----------|--------------------------------------|---------------|
| JOR559T | w/o Table Top Unit | \$1,482.00/ea |
| JOR559BT | w/o Table Top Unit without vaporizer | \$2,435.00/ea |
| JOR559TC | w/low/Tech V vaporizer | \$2,400.00/ea |
| JOR559TV | w/o Vaporizer | \$1,482.00/ea |

Isoflurane Vaporizer

Brand new vaporizers in familiar Tech III style. Features precision delivery and temperature compensation. Standard funnel fill, and can be mounted onto any brand anesthesia machine. Vaporizers shipped directly from manufacturer. Shipping charges billed at actual freight. THIS IS ISOFLURANE!!!

Refurbished. The standard vaporizer that has been a work horse of the veterinary field for many years. Vaporizers shipped directly from manufacturer. Shipping charges billed at actual freight.

- Temperature compensation.
- Precision delivery.
- One year warranty.



| | | |
|---------|-------------------------|---------------|
| JOR562A | Isoflurane Tech III | \$1,500.00/ea |
| JOR561 | Isoflurane Re-Furbished | \$1,050.00/ea |

Tech Vaporizer

Refurbished. For many years the veterinary industry's most popular vaporizer was the Tech III. The Tech IV is the next generation of vaporizer and offers many improvements. Vaporizers shipped directly from manufacturer. Shipping charges billed at actual freight. Can be tipped over and still function accurately. Increased accuracy to lower flow rates. Fits most standard machines. One year warranty.

- Temperature compensated.
- Precision delivery.

| | | |
|---------|----------------------|---------------|
| JOR561B | Tech III Refurbished | \$1,090.00/ea |
| JOR561A | Tech IV Refurbished | \$930.00/ea |



Tech IV

Tech III



Tech III Isoflurane Vaporizer 250cc

JOR562C \$1,700.00/ea

Anesthesia Products

Vaporizers & Supplies



Sevoflurane Vaporizer

Brand new vaporizers in familiar Tech III style. Features precision delivery and temperature compensation. Standard funnel fill, and can be mounted onto any brand anesthesia machine. Vaporizers shipped directly from manufacturer. Shipping charges billed at actual freight. THIS IS SEVOFLURANE!!!

| Item# | Details | Price |
|---------|----------------------|---------------|
| JOR562S | Sevoflurane Tech III | \$1,765.00/ea |

Sevoflurane Anti-Spill Pour Spout

This handy adapter screws onto gas agent bottle top and the other end fits snugly into the filling funnel on the gas vaporizer. It makes vaporizer refilling spill free. Color coded for agent type.

| | |
|---------|------------|
| JOR562Y | \$51.00/ea |
|---------|------------|

Halothane Anti-Spill Pour Spout

| | | |
|---------|-------------|------------|
| JOR562Z | 45cm X 35cm | \$51.00/ea |
|---------|-------------|------------|

Drager Isoflurane Vaporizer

North American Drager refurbished isoflurane vaporizer. These temperature compensated precision vaporizers have enjoyed wide-spread use in human hospitals. JorVet is offering fully refurbished units that fit standard veterinary anesthesia machines. Three-year warranty included.

| | | |
|---------|-------------------------------|-------------|
| JOR562D | Three-year warranty included. | \$936.00/ea |
|---------|-------------------------------|-------------|

Drager Sevoflurane Vaporizer

| | | |
|---------|-------------|---------------|
| JOR562E | Refurbished | \$1,100.00/ea |
|---------|-------------|---------------|

Sevoflurane Tech IV Refurbished Vaporizer

| | |
|---------|---------------|
| JOR562B | \$1,425.00/ea |
|---------|---------------|

Isoflurane Inhalant Anesthetic

| | | |
|-----------|------------|--|
| RXISO-100 | \$9.99/btl | |
|-----------|------------|--|

| | |
|-----------|-------------|
| RXISO-250 | \$21.50/btl |
|-----------|-------------|

Tech V Isoflurane Refurbished Vaporizer

Tec V Isoflurane Vaporizer. 250cc. Refurbished the newer model of the Tec Ohmeda series

| | | |
|---------|-------------|--|
| JOR561X | \$930.00/ea | |
|---------|-------------|--|

End Cap for vaporizer Male - Female

| | | |
|----------|---------|--|
| JOR561VC | \$56.00 | |
|----------|---------|--|

End Cap for vaporizer Male - Female

| | | |
|-----------|------------|--|
| JOR561VCM | \$36.00/ea | |
|-----------|------------|--|

Large Humidifier with Oxygen Dilutor

This device works by oxygen bubbling through a diffuser in a fluid. The humidifier has a dilutor to adjust the oxygen going through the diffuser.

| | |
|---------|------------|
| JOR948H | \$12.00/ea |
|---------|------------|

Thermoblocker Recovery Bag

Same heat reflective core material. The recovery bag works like a sleeping bag with two sides stitched together and integral Velcro strips on the other two sides.

| | | |
|---------|-------------|------------|
| JOR955A | 70cm x 45cm | \$36.00/ea |
| JOR955B | 45cm x 35cm | \$21.00/ea |

Oxygen Sensor Only

| | | |
|---------|-------------|--|
| JOR948S | \$180.00/ea | |
|---------|-------------|--|



Tracheotomy Tube

Pape's model. Nickel -plated brass.

| | | |
|---------|---------------------------------|------------|
| JOR144A | Papes Model 18mm I.D. 22mm O.D. | \$33.00/ea |
| JOR144B | Papes Model 22mm I.D. 28mm O.D. | \$33.00/ea |

Carbon Dioxide Absorbent

| | | |
|-------------|---------|-----------|
| RXS00A-SORB | 3lb bag | \$9.92/ea |
|-------------|---------|-----------|

Non-Rebreather Mask

Latex-free and available in a variety of styles, each mask is designed for patient comfort with a soft, anatomical form. Barbed fittings help prevent patient from disconnecting the mask while the elastic straps and adjustable nose clips secure it for a better fit. Pediatric. Non-Rebreather Mask, Reservoir Bag, Safety Vent, Check Valve, 7" (2.2m) tubing

| | | |
|---------|---|-------------|
| HCS4642 | Non-rebreathing Mask, Reservoir Bag, Safety Vent, Check Valve, 7" (2.2m) tubing | \$149.00/cs |
|---------|---|-------------|

Soda Lime

JorVet soda lime is a high-grade granular product that effectively absorbs carbon dioxide that is produced as an anesthesia by-product. It is a mixture of calcium hydroxide Ca(OH)₂ also known as lime plus a smaller amount of sodium hydroxide NaOH. Upon exposure to carbon dioxide CO₂, the calcium hydroxide converts to calcium carbonate CaCO₃. This prevents CO₂ buildup in a re-breathing circuit. The sodium hydroxide acts as a catalyst in the process. No potassium hydroxide (KOH) is present in JorVet soda lime; this helps to avoid the formation of toxic compounds such as Compound A and carbon monoxide. JorVet soda lime has a pH color change indicator that changes from white to violet when the soda lime needs to be changed. It will eventually return to its original color if not changed. Therefore, a good rule of thumb is to replace the soda lime every time the vaporizer is filled.

- Minimal dust
- No KOH-minimizing chance of anesthetic reactions that produce toxins
- Irregular particle size-creates more surface area
- Saturation indicator built-in changes from white to violet
- Particle size 4-8 USP Mesh (2.5mm-5mm)

| | | |
|---------|--------------------|------------|
| JOR553 | 3 lb. bag | \$7.50/ea |
| JOR553B | 5 Gallon container | \$84.00/ea |



Soda-Lime Canister

Pre filled canister is preferred by many clinics. Comparable with other brands of canister - identical in size and weight.

| | | |
|----------|-----------|-------------|
| JOR559D4 | 920 grams | \$220.00/ea |
|----------|-----------|-------------|



Jorvet Soda Lime Pre-Filled Canister

| | | |
|---------|---|-----------|
| JOR533C | Soda lime pre-filled canisterAudio-visual alarm | \$9.45/ea |
| JOR553C | Prefilled, 920 gramsAudio-visual alarm | \$9.45/ea |

Jorvet Audio-visual Alarm

This alarm both emits an audible alarm and a blinking signal when the oxygen pressure drops too low. Can be away from tank.

| | | |
|----------|-------------------------------------|-------------|
| JOR533AV | Audio-visual alarm | \$660.00/ea |
| JOR533EM | Dual tank manifold with switch port | \$864.00/ea |
| JOR533PS | Single setting pressure switch | \$408.00/ea |



13822 WEST BOULTON BLVD. METTAWA, IL 60045

WWW.SHOPMEDVET.COM

Phone 800-544-7521

299

Fax 800-204-2177

Anesthesia Products

Oxy Cage & Buster Cage

Jorvet Vapor Wand

Vapor Wand. Veterinarians often treat ferocious or vicious animals such as aggressive cats and dogs, small zoo animals, wildlife, primates, reptiles, and other exotic species. For proper examination or surgery, these animals need to be anesthetized. Older methods such as pole syringes and darts are high risk to both the animal and the veterinarian. Anesthesia chambers have size limitations, and transferring the patient safely into chambers can be risky. The development of anesthetic agents such as isoflurane can make induction faster, quieter, and safer.

David S. Hodgson DVM, DACVA at Kansas State

University Veterinary Teaching Hospital, developed the innovative Vapor Wand to deliver anesthetic vapors into enclosed cages and pet carriers. The Vapor Wand is a small round stainless steel vented probe with a cotton

wick. It is attached to a 400ml air pump. When a pre-measured

dose of liquid isoflurane is added to the wick, and the air pump is cycled, the liquid isoflurane is vaporized. Any animal may be quickly anesthetized by use of the Vapor Wand inserted into the sealed environment. The example shown is a transport kennel placed into a plastic bag. The Vapor Wand is inserted into the kennel and the air pump is cycled. The round viewing window allows for observation of the animal during induction of anesthesia. When induction is complete, the bag is opened. The animal may be maintained via mask or other anesthetic techniques.

Vapor Wand Kit. Includes:

- Vapor wand 32 1/2" L x 3/4" D
- 400ml reusable syringe
- Small viewing port with window
- Laminated dosage calibration chart
- Instructional CD-ROM

JOR990 \$180.00/ea

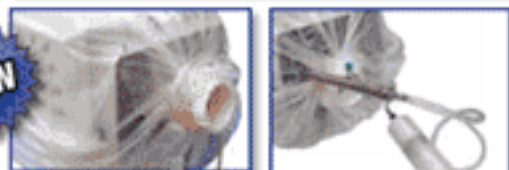
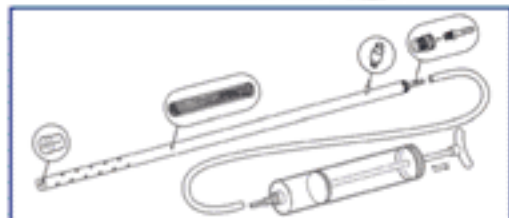
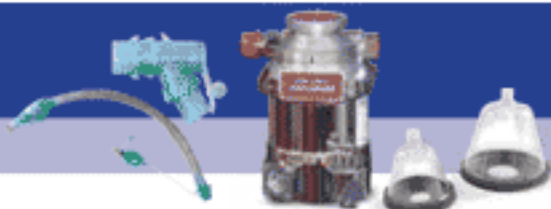

Jorvet Oxy Cage

This portable cage serves a variety of critical care needs. (Product may vary slightly from picture.) Includes:

- Oxy cage
- Two 9cc nebulizers (JOR949n)
- Humidifier canister (JOR653)
- Four lengths oxygen tubing, 7' L (JOR655)
- Christmas tree connector (JORS95c)
- Two 90° elbow connectors

The Oxy Cage is a specially modified lightweight transport kennel. Side windows are clear plexiglass. Special vents can be opened for ventilation. The door grill is backed with a removable clear plexiglass. A special lining in the door frame provides a tight seal when the door is closed. The floor has a raised comfortable floor grill (1/2 hH). Both temperature and humidity information are

provided via a digital monitor. Special connectors allow attachment of oxygen tubing, humidifiers, and medicated nebulizers. Any oxygen source with a flowmeter can be used (i.e., oxygen tank or oxygen concentrator).

| | | |
|---------|-------------------|-------------|
| JOR947 | Small, Complete | \$424.00/ea |
| JOR947A | Medium, Complete | \$570.00/ea |
| JOR947B | Large, Complete | \$670.00/ea |
| JOR947C | X-large, Complete | \$750.00/ea |



Buster ICU Cage

The Buster ICU cage offers the most affordable intensive care unit available. It can simply fold up into a small nylon bag for storage after use.

- Controlled oxygen therapy
- Can double as an anesthesia chamber
- Collapsible for daily storage and set up anywhere i.e. standard stainless cage Specifications on design
- PVC lined for easy cleaning
- Clear vinyl window covers for visualization
- Either warmth or cooling can be provided with reusable gel packs

Accessories include: oxygen accessory kit (JOR1057q)

- 6 color coded venturi oxygen delivery nozzles
- Small nebulizer
- Connecting T-piece
- Oxygen tubing 7ft (2.1m)

Oxygen Accessory Kit

6 color coded venturi oxygen delivery nozzles

- Small nebulizer
- Connecting T-piece
- Oxygen tubing 7ft (2.1m)

JOR1057Q Oxygen Accessory Kit (JOR1057q) \$48.00/ea

Buster Comfort Mattress

- Fits inside Buster ICU cage for soft patient comfort
- Waterproof black nylon cover with zipper
- Can be scrubbed clean then drip dry in minutes
- Withstands most disinfectants
- Includes gel pack that can provide heat (microwave) or cool (refrigerator)
- Gel packs are non-toxic if accidentally consumed
- Buster kennel mattress available separately with gel packs.



| | | |
|----------|-------------------------|-------------|
| JOR1057 | Small, 18" x 14" x 14" | \$220.00/ea |
| JOR1057A | Medium, 24" x 18" x 18" | \$260.00/ea |
| JOR1057B | Large, 44" x 26" x 26" | \$472.00/ea |

| | | |
|----------|--------------------------|-------------|
| JOR1058 | Small, 18" x 12" x 3.2" | \$54.00/ea |
| JOR1058A | Medium, 24" x 18" x 3.2" | \$86.00/ea |
| JOR1058C | Large, 26" x 24" x 3" | \$170.00/ea |

| | |
|---|---------------------|
| Therma-Kool  | |
| JOR1057X | 10" x 15" \$7.20/ea |

Anesthesia Products

Oxygen Concentrators & Supplies

Integra & Ragalia Oxygen Concentrators

Oxygen concentrators separate air into primary components such as oxygen and provide the lowest cost mechanism to do so. The Ragalia offers an ideal and innovative system for supplying oxygen to anesthesia machines and for emergency oxygen needs. This concentrator will extract medical grade O2 directly from the air and deliver it to a desired location.

The digital flow rate meter delivers 1-7 lpm or 1-10 lpm of continuous O2. If the flow meter rate is set at 1 lpm it will deliver a 95 percent O2 concentration, 5 lpm will deliver 90 percent concentration. Made specifically for the veterinary market.

Features:

- Reliable O2 production with constant delivery pressure
- Eliminates need for O2 tank
- Compact, lightweight, yet rugged environmentally tolerant design
- Quiet operation
- Easy-to-read digital flow meter
- Control knobs are large and easily accessible
- Self cleaning, minimal maintenance
- Low operating cost, 5 watt power consumption
- 14.7"W x 26"H x 10.1"D. 54 lbs. (24 Kg)

Three year warranty

Performance:

- Flow rate: variable 1/2-7 lpm (JOR744) or 1/2-10 lpm (JOR744a)
- O2 pressure 5 psi (37.9 Kpa) minimum
- O2 Concentration 95-92 percent at 0-3 lpm 95-90 percent at 3-5 lpm
- Designed for anesthesia machines, 2 maximum.

| | | |
|---------|--|---------------|
| JOR744 | 0-7 lpm Flow Rate. 16"W x 20"H x 8 1/2"D | \$1,599.00/ea |
| JOR744A | (JOR744) only with 0-10 lpm flow rate. 16"W x 20"H x 8 1/2"D | \$2,150.00/ea |



JOR744A



Oxygen Booster 90PSI with Relief Valve

The use of an oxygen booster, delivering oxygen at 5-7 PSI, may be combined with an oxygen concentrator. In cases where central oxygen or long oxygen hose lines are needed the oxygen booster should be used to increase oxygen pressure. Free standing metal cabinet uses 110V AC power via a 3-pronged plug. (not pictured)

JOR744C 16"W x 20"H x 8 1/2"D. 16"W x 20"H x 8 1/2"D \$3,250.00/ea

Oxygen Booster 55PSI

JOR744B 16"W x 20"H x 8 1/2"D. 36 lbs. 16"W x 20"H x 8 1/2"D \$2,106.00/ea

Pop-Off Valve Restrictor

The restrictor is placed on the pop-off valve exhaust port and the scavenge tubing is attached to the other end. The button on the device top is depressed to close the exhaust, thus allowing the bagging of the animal. The restrictor allows the anesthetist to leave the pop-off valve open, but the animal still may be bagged when necessary. This prevents the chance that the pop-off valve may be left accidentally closed, a situation which causes high pressure within the system, and can lead to respiratory damage and pneumothorax. Made from Delran, a sturdy, durable material.



JOR55903 \$57.00/ea **Jorvet**

Repair kit for JOR744 & JOR744A

Kit to rebuild compressor for Integra concentrators.

JOR744RK \$110.00/ea



Jorvet Booster Repair Kit

JOR744CRK \$96.00/ea



Jorvet Extension Piece for 2nd Vaporizer

JOR55902 \$39.00/ea



Jorvet Hose Assembly Kit for JOR744C

JOR744HK \$48.00/ea



Isoflurane Inhalant Anesthetic

A non-flammable, non-explosive Inhalation anesthetic.

Starting at **\$9.99**

RXIS0-100 100ml \$9.99
RXIS0-250 250ml \$21.50

Prices subject to change Call before ordering



YOUR ONE STOP SHOP FOR VET/MED SUPPLIES

13822 WEST BOULTON BLVD. METTAWA, IL 60045

WWW.SHOPMEDVET.COM

Phone 800-544-7521

301

Fax 800-204-2177

Anesthesia Products

Chambers, Masks & Tubes



Jor-Vet Fresh Breath Canister Installation Kit

Breath Fresh Anesthesia Gas Filter. Activated charcoal canisters remove up to 50g of waste anesthetic gas. They attach to standard 19mm scavenger hose.

Features:

- Inexpensive refills available
- Lasts 12-15 hours of anesthesia
- Simple to use: connect and ready to go
- Mounts right on anesthesia machine pole

Mounting Kit includes:

- Mounting Bracket for attachment to anesthesia pole
- Breath Fresh Canister
- 19mm Tubing 40" L

| | | |
|---------|-----------------------|------------|
| JOR304K | Mounting Kit Complete | \$21.60/ea |
| JOR304 | Canister Only | \$9.00/ea |
| JOR304K | Mounting Kit Complete | \$21.60/ea |

Breath Fresh Refill Pack, 200 gram

| | | |
|---------|--|-----------|
| JOR304R | DIMENSIONS: H 15 CM (6") WEIGHT OF ACTIVE COMPONENTS: 200g DIAMETER: 7.5CM (3") CONNECTOR: 19MM O.D. | \$5.10/ea |
|---------|--|-----------|



Disposable Anesthesia Mask

A crystal clear plastic material with inflation/deflation valve for better patient fitting. Inexpensive. 15mm OD fitting. Five different sizes. This one-way valve inflates with any standard syringe.

| | | |
|----------|----------------|------------|
| JOR298DA | Large | \$8.70/ea |
| JOR298DB | Med-Large | \$8.70/ea |
| JOR298DC | Medium | \$9.00/ea |
| JOR298DD | Medium-Small | \$9.00/ea |
| JOR298DE | Small | \$9.00/ea |
| JOR298DS | Set Of 5 Sizes | \$34.50/ea |

Disposable Respiratory Masks

| | |
|-------------|-----------|
| JOR298DC-DE | \$9.00/ea |
|-------------|-----------|



Anesthesia Chamber **Jor-Vet**

The Lexan anesthesia chamber provides a simple method of induction. Chamber induction reduces physical restraint which minimizes stress and reduces the chance of injury to the operator and animal. The divider system allows for up to four different chamber sizes within one unit: 18" x 9" x 9" / 12" x 9" x 9" / 6" x 9" x 9" Unit weighs 10 lbs.

| | | |
|--------|-----------------------|-------------|
| JOR265 | 18" x 9" x 9", 10 Lbs | \$198.00/ea |
|--------|-----------------------|-------------|



Anesthesia Breathing Tube

Corrugated black rubber conductive breathing tubes with natural rubber 22mm cuff inserts.

| | | |
|---------|-------|------------|
| JOR249H | 36" L | \$42.00/ea |
| JOR249J | 40" L | \$48.50/ea |

Anesthesia Scavenging Hose

Anesthesia Scavenging Hose 19mm

| | | |
|---------|-----------------|-----------|
| JOR248Q | 19mm, 10ft Roll | \$7.80/ea |
| JOR248T | 22mm, 10ft Roll | \$6.00/ea |



Halls Anesthesia Mask

Soft, malleable black rubber. This mask will conform to the animal's muzzle shape, allowing a custom fit. Standard 15mm connection to anesthesia circuit.

| | | |
|----------|--------|-------------|
| JOR298HA | Small | \$126.00/ea |
| JOR298HB | Medium | \$126.00/ea |
| JOR298HC | Large | \$129.00/ea |

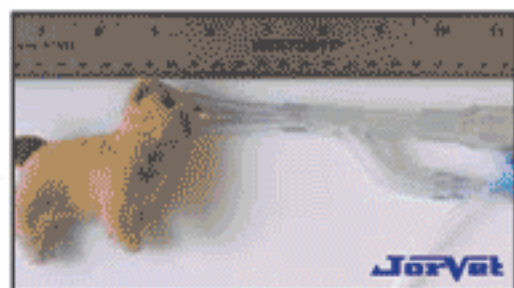

Exotic/Small Animal Anesthesia Mask and Non-Rebreathing Circuit

These especially small masks were specifically designed for use on small exotics such as pocket pets and birds. The small circuit hooks up the same way as a nonrebreathing circuit does to an anesthesia machine.

The masks fit tight around the nose and mouth. Soft conforming cone can be trimmed to custom fit animal's nose. The oxygen/gas tube position can be adjusted inside mask. Also circuit can be taped to the table to help keep it positioned on the animal's nose or muzzle. **Jor-Vet**

| | | |
|----------|----------------------------|------------|
| JOR297AN | 9 mm Opening, 10" tubing | \$29.00/ea |
| JOR297BN | 12.5mm Opening, 10" tubing | \$29.00/ea |
| JOR297CN | 14.0mm Opening, 10" tubing | \$29.00/ea |
| JOR297DN | Set of all three sizes | \$79.30/ea |



Mask One Way Valve

Stop anesthesia gas. This handy valve allows the fresh gas to be shut off when not needed. Fits inline between mask or endotracheal tube and anesthesia circuit. Especially useful when using anesthesia mask. **Jor-Vet**

| | | |
|----------|------------|------------|
| JOR298MV | Valve Only | \$55.00/ea |
|----------|------------|------------|



Jorvet Anesthesia Mask

Anesthesia Masks with low dead space. Clear plexiglass masks with black rubber diaphragm.

| | | |
|-----------|-------------------------|------------|
| JOR298C | Canine 5" Opening | \$30.00/ea |
| JOR298CD1 | Diaphragm Only (Canine) | \$13.50/ea |
| JOR298F | Feline 3.5" Opening | \$30.00/ea |
| JOR298FD1 | Diaphragm Only (Feline) | \$13.50/ea |

13822 WEST BOULTON BLVD. METTAWA, IL 60045

WWW.SHOPMEDVET.COM

Phone 800-544-7521

302

Fax 800-204-2177

Anesthesia Products

Breathing Bags & Oxygen Systems



Reusable Black Rubber Breathing Bag **Jorvet**

Our oval/flat breathing bags are manufactured from black conductive natural rubber. High quality and long lasting.

| | | |
|----------|--------------------------|------------|
| JOR249R | 3 Liter 22mm Neck Insert | \$22.50/ea |
| JOR249R2 | 2 Liter 22mm Neck Insert | \$22.50/ea |
| JOR249S | 3 Liter 22mm Neck Insert | \$24.00/ea |
| JOR249T | 4 Liter 22mm Neck Insert | \$32.40/ea |
| JOR249V | 5 Liter 22mm Neck Insert | \$33.00/ea |
| JOR249E | 6 liter 22mm Neck Insert | \$38.00/ea |



Disposable Breathing Bag **Jorvet**

High quality latex breathing bags. **Jorvet**

| | | |
|------------|------------------------|------------|
| JOR249A | .5 Liter | \$6.00/ea |
| JOR249B | 1 Liter | \$6.00/ea |
| JOR249B2 | 2 Liter | \$6.00/ea |
| JOR249C | 3 Liter | \$6.00/ea |
| JOR248EAD1 | 1 Liter w/bleed valve | \$12.00/ea |
| JOR248ED1 | .5 Liter w/bleed valve | \$13.50/ea |



Jorvet Resuscitation Bag



For emergency artificial respiration. This device is ideal for administering either pure oxygen or room air to oxygen deprived patients. Special valve allows lung inflation upon compression of bag and passive exhalation of CO2 while fresh air refills the compressor bag. Two options feature your choice of hooking up to a central oxygen source or detaching and using room air. Attachment B will fit standard endotracheal tube or can be used with an airtight mask. Compression bag is heavy duty blue rubber.

| | | |
|---------|--------------------------|------------|
| JOR247A | 3 Liter 22mm Neck Insert | \$50.10/bq |
| JOR247 | 3 Liter 22mm Neck Insert | \$57.00/ea |

JOR686



Tank not included

JOR686A



JOR687A



NEW

Tank not included

JOR687



Tank not included



Oxygen Cylinder/Tank Racks and Carts

Oxygen tanks are cumbersome and top-heavy items. The danger to clinic personnel from a dropped or toppled oxygen tank can be minimized with proper storage and handling. Jorvet offers a number of oxygen tank racks and carts to safely handle the common "H" or "E" cylinders used in veterinary facilities. Various regulators and yokes are also available.

| | | |
|---------|----------------------------------|-------------|
| JOR686 | 12"W x 8"L x 39"-44"H. 71/2 lbs. | \$54.00/ea |
| JOR686A | 9 1/2"D x 4 1/2"H. 7 1/2 lbs. | \$39.00/ea |
| JOR686B | 5"W x 5"L x 16"H. 4 lbs. | \$90.00/ea |
| JOR687 | 14"W x 20"L x 49"H. 29 lbs. | \$260.00/ea |
| JOR687A | 19"W x 12"L x 39"H. 30 lbs. | \$82.00/ea |
| JOR688 | "E" Cylinder oxygen tank | \$89.00/ea |
| JOR686W | Wrench for "E" Tank | \$6.00/pk |

Barbed Oxygen Connector

| | | |
|---------|-------------|-----------|
| JOR686X | 15mm id 2pk | \$6.00/pk |
|---------|-------------|-----------|

Portable Oxygen Delivery System

The need for an emergency oxygen source can arise at any time. A clinic should be adequately prepared with the proper equipment that is made readily available and is stand-alone. Most clinics do not have central oxygen or may have just one oxygen tank that is dedicated to the anesthesia machine. The Jorvet portable oxygen delivery system is everything you need just add the oxygen!

The system includes:

- "E" oxygen tank with Yoke head - will hold up to 425 liters when full. (JOR688)
- Clic style regulator for "E" Yoke head, 0-15LPM dial. (JOR686R)
- Light weight wrench for opening/closing oxygen tank regulator. (JOR686W)
- Transport cart with 2 wheels that can go anywhere in the clinic. (JOR686)
- Clear oxygen tubing 7ft. Length (4pk) with a female DISS
- Fitting. (JOR655)
- Oxygen catheter 14fr delivers oxygen by nasal insertion or "blowby". (JOR656)
- Connectors: allow connection to standard anesthesia masks.

JOR686K \$210.00/ea

Jorvet



Clic Style Oxygen Regulator

JOR686R 0-15LPM \$84.00/ea



SEE OUR PHARMACEUTICAL SECTION AND SAVE ON YOUR NEXT MED ORDER

13822 WEST BOULTON BLVD. METTAWA, IL 60045

WWW.SHOPMEDVET.COM

Phone 800-544-7521

303

Fax 800-204-2177

Anesthesia Products

Oxygen connectors & Gas Hose Assembly

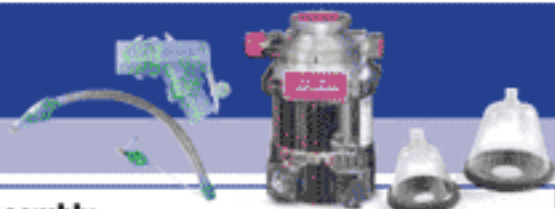

Jorvet Oxygen Connectors and Gas Hose Assembly

A tremendous variety of options are available to design your own oxygen delivery system or add to an existing setup. A wide range of patterns of oxygen connectors is available with the DISS and Ohio style, quick/connect being the most popular.

Jorvet

NOTES about connectors:

DISS = Diameter Index Safety System. These fittings are designed to prevent errors and standardized connections. Only oxygen DISS male threads will match female oxygen DISS threads. Nitrous oxide and other gases each have their own thread patterns.

NPT = National Pipe Thread Sizing.

These relate to anesthesia machine fittings.

Gas Hose Assembly. Jorvet

Design your own custom oxygen or other gas line. FDA medical grade conductive hose that is kink resistant, lightweight, and reinforced with tough nylon braiding. Fittings are chrome-plated brass. Standard 1/4" i.d. • Color-coded to specific gas; **green = oxygen**

Oxygen Hose Assembly. (hose not included) Jorvet

| | One-End Connector | | Opposite-End Connector | |
|-----------|-------------------|---|------------------------|------------|
| JOR538B | Female DISS | x | female DISS | \$37.50/ea |
| JOR538E | Female Ohio | x | male Ohio | \$73.00/ea |
| JOR538F | Female DISS | x | Female Chemtron | \$93.00/ea |
| JOR538M | Female DISS | x | Male Chemtron | \$45.00/ea |
| JOR538C40 | Ferrule .500" ID | | | \$1.50/ea |
| JOR538C10 | DISS female (hex) | | O2 Click style | \$6.90/ea |

Oxygen Hose Jorvet

| | | |
|----------|----------|-----------|
| JOR540## | Per Foot | \$2.40/ea |
|----------|----------|-----------|

Combine connectors and amount of tubing needed for total pricing.
JOR540 O2 hose specify length (feet).

Ordering procedure for oxygen hoses if not choosing one hose of those listed above.

1. Pick two ends of hose desired
2. Determine the number of oxygen hose in feet desired (JOR540)



JOR533H



JOR533J



JOR535A



JOR536T



JOR536A



JOR536X



JOR536FA



JOR536YB



JOR536Y

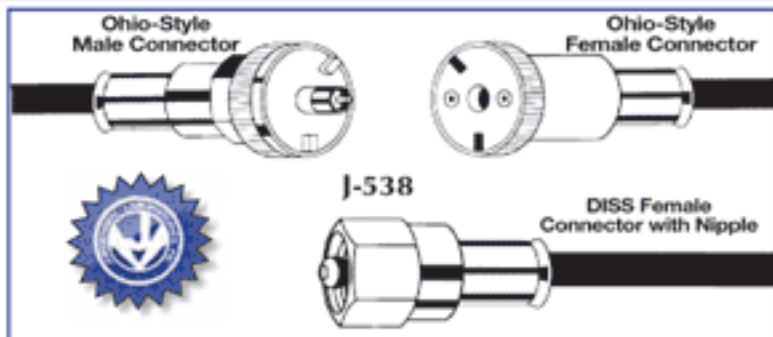

DISS fitting Barbed end

| | |
|---------------------------------------|------------|
| FEMALE DISS W/ HOSE, BARB AND FERRULE | |
| JOR533G | \$18.30/ea |

| | |
|--------------------------------|------------|
| DISS MALE FITTING W/BARBED END | |
| JOR533H | \$12.00/ea |

| | |
|---|------------|
| DISS FEMALE HAND TIGHT TWIST OFF W/BARBED END | |
| JOR533J | \$15.00/ea |

Ohio Quick Connect Barbed fitting

| | |
|--------------------------|------------|
| OHIO FEMALE & BARBED END | |
| JOR535FA | \$60.30/ea |

| | |
|------------------------|------------|
| OHIO MALE & BARBED END | |
| JOR535A | \$36.00/ea |

Chemtron Barb fitting

| | |
|------------------------------|------------|
| CHEMTRON FEMALE & BARBED END | |
| JOR536FA | \$75.00/ea |

| | |
|----------------------------|------------|
| CHEMTRON MALE & BARBED END | |
| JOR536A | \$28.50/ea |

Puritan-Bennett

| | |
|---|------------|
| PURITAN BENNETT FEMALE FITTING W/BARBED END | |
| JOR536XA | \$84.00/ea |

| | |
|---|------------|
| PURITAN BENNETT MALE FITTING W/BARBED END | |
| JOR536X | \$20.00/ea |

Schrader

| | |
|---|------------|
| SCHRADER FEMALE FITTING WITH BARBED END | |
| JOR536YA | \$77.00/ea |

| | |
|------------------------------------|------------|
| SCHRADER MALE FITTING W/BARBED END | |
| JOR536Y | \$30.00/ea |

| | |
|-----------------------------|------------|
| SWIVEL MALE SCHRADER W/HOSE | |
| JOR536VS | \$25.00/ea |

Oxequip

| | |
|------------------------------------|------------|
| OXYEQUIP MALE FITTING W/BARBED END | |
| JOR536T | \$27.00/ea |

| | |
|--|--|
| | |
|--|--|

| | |
|--|--|
| | |
|--|--|

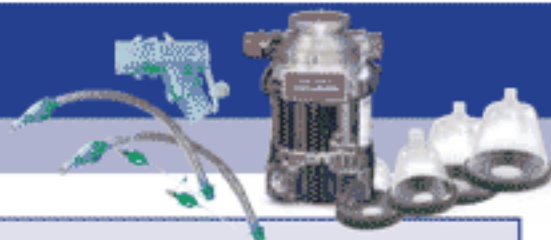

Other Miscellaneous Connectors

Female diss to male diss w/check valve

Female DISS to male DISS check valve gives one-way flow

JOR533X \$16.20/ea 

Male DISS to Female DISS w/reverse check valve

Male DISS to female DISS with reverse check valve gives one-way flow

JOR533Z \$18.70/ea 

1/4" NPT female x 1/4" male check valve gives one-way flow

JOR538X \$46.00/ea 

Male NPT to hose barb 1/4" NPT x 1/4" barb

JOR538MN \$5.10/ea



DISS male check valve x 1/4 NPT

JOR539DMC \$18.00/ea 

DISS male x 1/4 NPT

JOR539DM \$7.50/ea 

JORVET Oxygen Fittings.

These are double end connectors that allow connecting one pattern of connector to a DISS connector

Ohio Chemtron

| | | |
|----------|------------------------------------|------------|
| JOR535FC | Male DISS to female Ohio connector | \$75.00/ea |
| JOR535FB | Female Ohio to DISS female | \$75.00/ea |
| JOR536FB | Female Chemtron to DISS male | \$78.00/ea |
| JOR536FC | Female Chemtron to DISS female | \$78.00/ea |
| JOR535B | Male Ohio to DISS male | \$31.50/ea |
| JOR536B | Male Chemtron to DISS male | \$28.50/ea |
| JOR535C | Male Ohio to DISS female | \$34.50/ea |
| JOR536BA | Male Chemtron to DISS female | \$30.00/ea |

Wye Adapters

Connects two machines or hoses to one outlet

| | | |
|----------|---|-------------|
| JOR537D | Female DISS (hand tight) with two male DISS connectors with check valves. | \$75.00/ea |
| JOR537 | One male Ohio with two female Ohio | \$210.00/ea |
| JOR537A | One male Ohio with two female DISS | \$105.00/ea |
| JOR537C | Chemtron male quick connect with two female Chemtron connects. | \$180.00/ea |
| JOR537E | Female Ohio with two female DISS hand tight | \$112.00/ea |
| JOR537CH | Chemtron female/w/DISS | \$200.00/ea |

Miscellaneous Connectors

| | | |
|---------|--|------------|
| JOR533M | Male DISS/male DISS fitting | \$6.00/ea |
| JOR533F | Female DISS/female DISS fitting | \$15.00/ea |
| JOR533X | Female DISS to male DISS check valve gives one-way flow | \$16.20/ea |
| JOR533Z | Male DISS to female DISS with reverse check valve gives one-way flow | \$18.70/ea |

Primary valve kit w/white insert

JOR537VK \$33.00/ea

Nitrogen Manifold

Nitrogen manifold for H-tank

JOR533NH \$828.00/ea

Nitrogen manifold w/ pressure switch port

JOR533NHP \$795.00/ea

Nitrogen adapter DISS

JOR539DMN \$28.00/ea

Nitrous DISS outlet

JOR537ND \$92.50/ea

JOR536FA



JOR538X



JOR533M



JOR533F



JOR536FB



JOR536FC



JOR539DM



JOR539DMC



JOR537d



JOR537C



JOR537



JOR535B

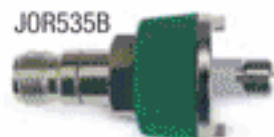

JOR536BA



JOR535FC

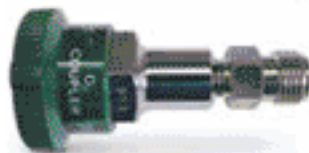

JOR535FB



JOR535C



JOR536B



Anesthesia Products

Oxygen Hookups Regulators & Mounting Yoke

Wall Mount. Two types:

- Recessed: Fit flush with wall similar to electrical outlet
- Surface: Placed outside the wall

| | | |
|---------|---|-------------|
| JOR537Q | Ohio Female Quick Disconnect. Recessed. | \$94.00/ea |
| JOR537R | Male DISS. Recessed. | \$94.00/ea |
| JOR537S | Male DISS. Surface. | \$112.00/ea |
| JOR537T | Ohio Female Quick Disconnect. Surface. | \$112.00/ea |
| JOR537V | Male DISS Ceiling Outlet. | \$94.00/ea |
| JOR537W | Chemtron female, wall recessed, quick disconnect, similar to JOR537q, but Chemtron style, not Ohio-style. | \$97.00/ea |



"Ganging" medical gas outlets has been done in human hospitals for many years. Now veterinarians are adding more gas and vacuum uses in their hospitals.

In addition to our oxygen outlets, you can order nitrous oxide, vacuum suction, and nitrogen outlets. They are ordered individually — this is the outcome when they are "ganged" together.

| | | |
|------------|-------------------------------|------------|
| JOR537NSC | Nitrous ceiling outlet | \$92.50/ea |
| JOR537NSWC | Nitrous chemtron wall outlet | \$92.50/ea |
| JOR537AVD | Vacuum DISS outlet | \$92.50/ea |
| JOR537VAC | Chemtron vacuum outlet | \$87.00/ea |
| JOR537NW | Nitrogen recessed wall outlet | \$94.00/ea |

Hoses and connectors are available, call for more information.



Dual Tank Manifold **JorVet**

This dual tank manifold allows delivery of oxygen throughout the hospital or clinic via wall outlets or ceiling drops. The system consists of two pigtail hoses that connect to the "H" tanks. Regulator and volume gauges are included. Then copper pipe (not provided) is plumbed to areas of the hospital requiring oxygen. The unit is wall mounted.

JOR533MH \$828.00/ea

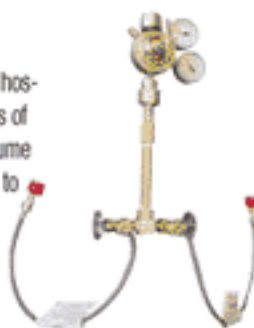

Vacuum Regulator

Vacuum/Suction Regulator for central vacuum/suction outlet with Chemtron connection. Use with JOR537vac shown above.

JOR530VR \$240.00/ea



Tank Mounting Double Cylinder Yoke **JorVet**

Small Animal Lexus Anesthesia System. Performance for a high standard of care with economy of initial investment. Precise machined fittings for an airtight connection. Powder coat finish is attractive and easy to clean. Available in mobile stand or table top models. Will accept most precision vaporizers. Soda lime canister is protect by its location under block. Also quick turn knob for each change of exhausted soda lime. Includes two anesthesia circuits, universal F circuit and non-breathing circuit.

JOR560E Protected, enclosed flowmeter with 200cc 4 lpm setting integrated O2 flush valve set at 15 lpm Smaller size, 970cc versus standard 1300cc

\$495.00/ea



Single "E" tank holder

JOR560ES \$360.00/ea

Single Step Oxygen Regulator for H- Type Nitrogen Cylinder

JOR533N \$254.00/ea



13822 WEST BOULTON BLVD. METTAWA, IL 60045

WWW.SHOPMEDVET.COM

Phone 800-544-7521

306

Fax 800-204-2177

Anesthesia Products

Oxygen Regulators and flowmeters

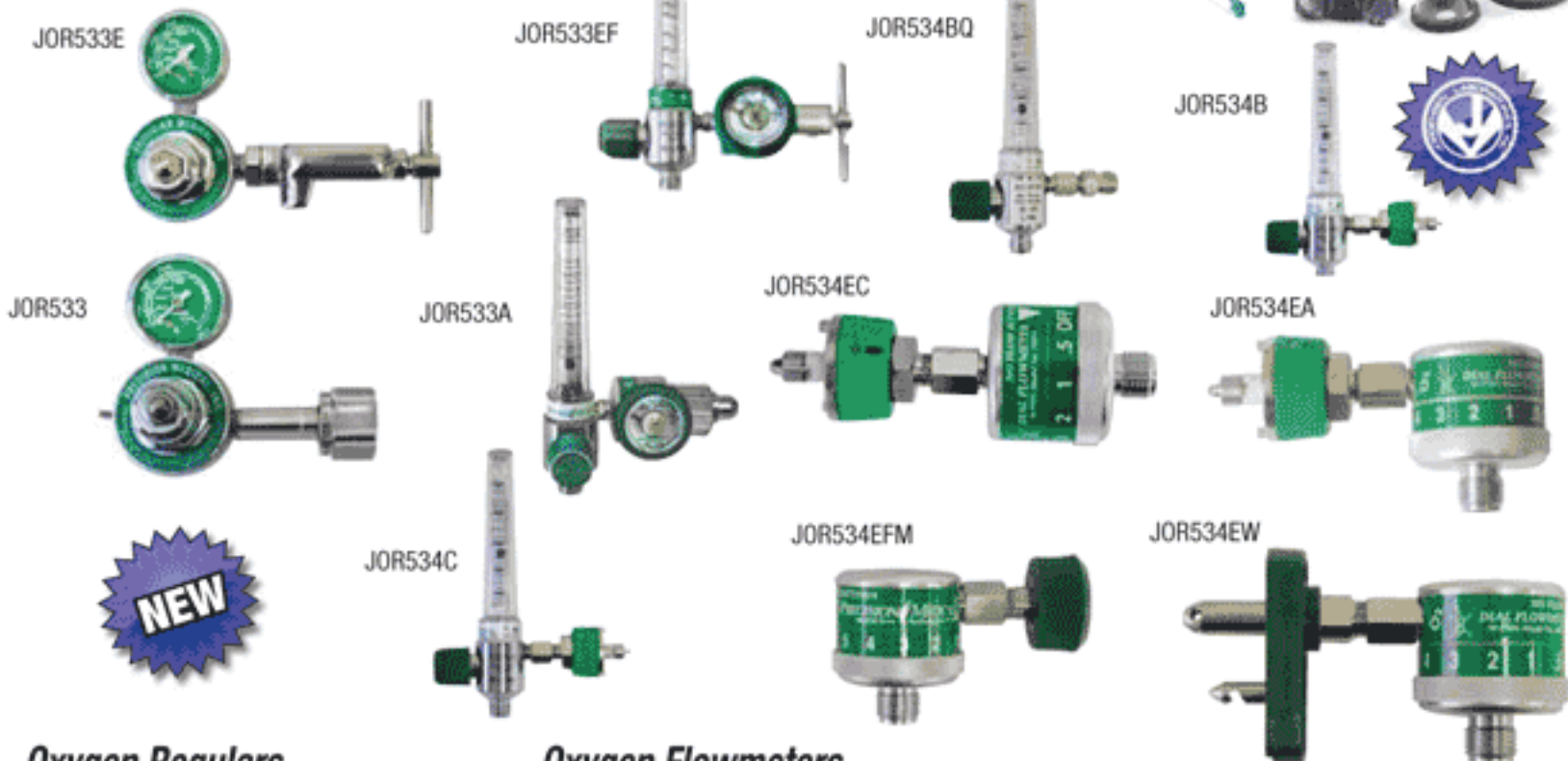

Oxygen Regulars

"H" Cylinder **JorVet**

Pressure regulator for large H type oxygen cylinder. Male DISS outlet. Preset standard 50 psi outlet pressure 0-4000 PSI high pressure gauge indicates remaining cylinder contents

JOR533 \$140.00/ea

"H" Cylinder w/Flowmeter

Pressure Regulator for large H-type oxygen cylinder with addition of flowmeter 0-15 liters-per-minute. Also has pressure gauge indicating remaining cylinder contents. **JorVet**

JOR533A \$224.00/ea

"E" Cylinder **JorVet**

Pressure Regulator for E-type cylinder with pin indexed yoke and male DISS connector. Also has pressure gauge indicating remaining cylinder contents.

JOR533E \$150.00/ea

"E" Cylinder w/Flowmeter

Pressure Regulator for E-type cylinder with pin indexed yoke, attached flowmeter 0-15 liters-per-minute, and male DISS connector.

JOR533EF \$228.00/ea **JorVet**

Oxygen Flowmeters

Flowmeter 0-3 Liters/Minute

- Clearly marked with large numbers
- Designed for accuracy and durability
- Chrome body
- Standard DISS fittings

JOR534A \$120.00/ea

Flowmeter 0-5 Liters/Minute

- Clearly marked with large numbers
- Designed for accuracy and durability
- Chrome body
- Standard DISS fittings

JOR534B \$79.50/ea

JOR534BQ \$88.00/ea

Flowmeter 0-15 Liters/Minute

JOR534C \$81.00/ea

JOR534D \$182.00/ea **JorVet**

Pin Indexed Yoke

Pin Indexed Yoke. Oxygen only.

JOR541 \$45.00/ea

Ceiling Dial Flowmeter

Many ceiling drops and wall outlets can be connected and a flow meter easily setup. Outlet end is a male DISS fitting. Possible connections include (JOR655) clear oxygen tubing.

JOR534EC \$94.00/ea **JorVet**

Wall Mount Dial Flow Meter

Chemtron male connect with dial flowmeter 1-15 LPM. Outlet end is a male DISS fitting.

JOR534EW \$87.00/ea **JorVet**

Dial Flowmeter w/Female DISS & Male DISS **JorVet**

Wall style Quick release female DISS flowmeter, can hook right to male DISS i.e. "H" tank regulator. Dial flowmeter 1-15 LPM. Outlet end is a male DISS fitting.

JOR534EFM \$75.00/ea

Wall Style Ohio Male Quick Connect w/Male

JOR534EA \$94.00/ea **JorVet**

Anesthesia Products

Endotracheal Tubes



| | | |
|----------|-------|-----------|
| ENDO3.0C | 3.0mm | \$1.99/ea |
| ENDO3.5C | 3.5mm | \$1.99/ea |
| ENDO4.0C | 4.0mm | \$1.99/ea |
| ENDO4.5C | 4.5mm | \$1.99/ea |
| ENDO5.0C | 5.0mm | \$1.99/ea |
| ENDO5.5C | 5.5mm | \$1.99/ea |
| ENDO6.0C | 6.0mm | \$1.99/ea |
| ENDO6.5C | 6.5mm | \$1.99/ea |
| ENDO7.0C | 7.0mm | \$1.99/ea |
| ENDO7.5C | 7.5mm | \$1.99/ea |
| ENDO8.0C | 8.0mm | \$1.99/ea |
| ENDO8.5C | 8.5mm | \$1.99/ea |

| | | |
|-----------|--------|------------|
| ENDO9.0C | 9.0mm | \$1.99/ea |
| ENDO9.5C | 9.5mm | \$1.99/ea |
| ENDO10.0C | 10.0mm | \$1.99/ea |
| ENDO10.5C | 10.5mm | \$14.00/ea |
| ENDO11.0C | 11mm | \$14.00/ea |
| ENDO12.0C | 12.0mm | \$16.00/ea |
| ENDO13.0 | 13.0MM | \$14.00/ea |



Cuffed Endotracheal Tube

Murphy type high volume low pressure. Made of thermosensitive clear PVC that softens at body temperature. Radiopaque line to confirm correct tube placement by X-ray. The smooth tip helps to minimize trauma during intubation. Oral or nasal intubation.
Magill Curve. Murphy Eye. Sterile. Single Use.

| | | |
|---------|-------|------------|
| JOR148A | 2.5mm | \$28.50/ea |
| JOR148B | 3.0mm | \$28.50/ea |
| JOR148C | 3.5mm | \$28.50/ea |
| JOR148D | 4.0mm | \$28.50/ea |
| JOR148E | 4.5mm | \$28.50/ea |
| JOR148F | 5.0mm | \$28.50/ea |
| JOR148G | 5.5mm | \$28.50/ea |
| JOR148H | 6.0mm | \$28.50/ea |
| JOR148I | 6.5mm | \$28.50/ea |
| JOR148J | 7.0mm | \$28.50/ea |
| JOR148K | 7.5mm | \$28.50/ea |
| JOR148L | 8.0mm | \$28.50/ea |

| | | |
|---------|-------------------|-------------|
| JOR148M | 8.5mm | \$28.50/ea |
| JOR148N | 9.0mm | \$28.50/ea |
| JOR148O | 9.5mm | \$28.50/ea |
| JOR148P | 10.0mm | \$28.50/ea |
| JOR148Q | 10.5mm | \$28.50/ea |
| JOR148R | 11.0mm | \$28.50/ea |
| JOR148S | 12.0mm, w/adaptor | \$115.50/ea |
| JOR148T | 13.0mm, w/adaptor | \$115.50/ea |
| JOR148U | 14.0mm, w/adaptor | \$119.50/ea |
| JOR148V | 16mm, w/adaptor | \$119.50/ea |

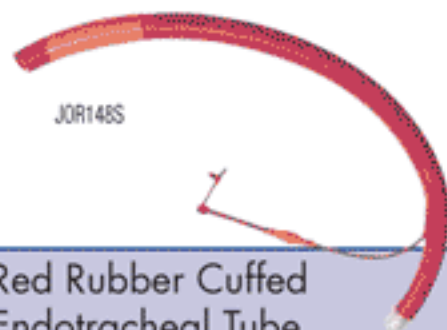

Red Rubber Cuffed Endotracheal Tube

Available in .5mm increments from 2.5 to 16.0mm. Murphy eye. Red rubber. Hard-to-find extra-large size now available.
v(adaptor not included except where specified)

| | | |
|---------|--------|-----------|
| JOR149A | 5.0mm | \$4.20/ea |
| JOR149B | 5.5mm | \$4.20/ea |
| JOR149C | 6.0mm | \$4.20/ea |
| JOR149D | 6.5mm | \$4.20/ea |
| JOR149E | 7.0mm | \$4.20/ea |
| JOR149F | 7.5mm | \$4.26/ea |
| JOR149G | 8.0mm | \$4.26/ea |
| JOR149H | 8.5mm | \$4.26/ea |
| JOR149I | 9.0mm | \$4.25/ea |
| JOR149J | 9.5mm | \$4.05/ea |
| JOR149K | 10.0mm | \$4.25/ea |
| JOR149L | 10.5mm | \$9.60/ea |
| JOR149M | 11.0mm | \$9.60/ea |

| | | |
|----------|-------|-----------|
| JOR149VC | 3.5mm | \$6.90/ea |
| JOR149XC | 4.0mm | \$7.05/ea |
| JOR149YC | 4.5mm | \$6.90/ea |

Non-Cuffed **Jor-Vet**

| | | |
|---------|--------|-----------|
| JOR149T | 2.5 mm | \$4.05/ea |
| JOR149U | 3.0mm | \$4.05/ea |
| JOR149V | 3.5mm | \$4.05/ea |
| JOR149Y | 4.5 mm | \$4.05/ea |

Endotracheal Tube Styler

Cuffed Endotracheal Tube. Softens at body temperature, reducing postoperative irritation. Blue-tinted PVC tube complete with connector. Available in 0.5mm increments for 3.5mm to 11mm.

| | | |
|-----------|--------|------------|
| JOR149STL | 5mm5mm | \$20.70/ea |
| JOR149STS | 2mm2mm | \$20.70/ea |

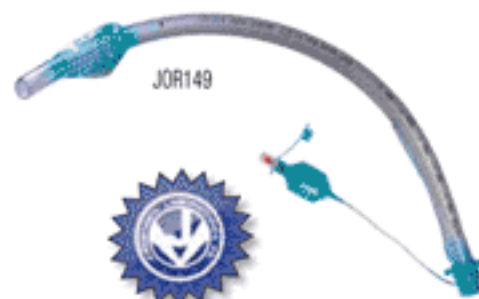

Jor-Vet Cuffed Endotracheal Tube

Softens at body temperature, reducing postoperative irritation. Blue-tinted PVC tube complete with connector. Available in 0.5mm increments from 3.5mm to 11mm

Anesthesia Products

Endotracheal Tubes

Silicon Endo Tube w/Connector

Silicone is the preferred material for endotracheal tubes. However, until now the cost was considered too high for use in most veterinary clinics. This is especially true on the larger sizes above 10mm.

- Endotracheal tube with inflatable cuff
- Connector included
- Lateral murphy eye at distal tip
- Sizes 3mm to 14mm
- Fully transparent
- Silicone Material Benefits:
 - Patient comfort. Silicone is a soft material that conforms to body contours. The soft distal tip lessens the chance for any airway tissue damage.
 - Reusability. Intended to be used over and over again. Silicone resists deterioration better than PVC or red rubber
 - Transparent. See any blood and mucous if they develop.



Series JOR615



JorVet

| | | |
|---------|---|------------|
| JOR615A | Endotracheal Tube, 3mm i.d. 14fr 4.7mm o.d. 16cm L balloon 3cm L | \$9.90/ea |
| JOR615B | Endotracheal Tube, 4mm i.d. 18fr 6.0mm o.d. 18cm L balloon 3cm L | \$9.90/ea |
| JOR615C | Endotracheal Tube, 5mm i.d. 20fr 7.3mm o.d. 20cm L balloon 4cm L | \$9.90/ea |
| JOR615D | Endotracheal Tube, 6mm i.d. 28fr 8.7mm o.d. 28cm L balloon 4cm L | \$9.90/ea |
| JOR615E | Endotracheal Tube, 7mm i.d. 30fr 10.0mm o.d. 30cm L balloon 5cm L | \$11.70/ea |
| JOR615F | Endotracheal Tube, 8mm i.d. 33fr 11.0mm o.d. 33cm L balloon 5cm L | \$11.70/ea |
| JOR615G | Endotracheal Tube, 9mm i.d. 37fr 12.3mm o.d. 34cm L balloon 5cm L | \$13.20/ea |
| JOR615H | Endotracheal Tube, 10mm i.d. 43fr 14.3mm o.d. 36cm L balloon 5cm L | \$18.00/ea |
| JOR615J | Endotracheal Tube, 11mm i.d. 47fr 15.7mm o.d. 40 cm L balloon 5cm L | \$22.50/ea |
| JOR615K | Endotracheal Tube, 12mm i.d. 51fr 17.0mm o.d. 44cm L balloon 5cm L | \$25.50/ea |
| JOR615M | Endotracheal Tube, 14mm i.d. 57fr 18.0mm o.d. 48cm L balloon 5cm L | \$33.00/ea |

JorVet

NOTE: Not autoclavable.

Sheridan Endotracheal Tube Cuffed

Sheridan Endotracheal Tube. High quality clear PVC tubes but are inexpensive. Uniform inflatable cuff. Sterile.



| | | |
|---------|--------|-----------|
| JOR835B | 3.5mm | \$6.15/ea |
| JOR835C | 4.0mm | \$6.15/ea |
| JOR835D | 4.5mm | \$6.15/ea |
| JOR835F | 5.5mm | \$6.15/ea |
| JOR835G | 6.0mm | \$6.15/ea |
| JOR835J | 7.0mm | \$6.15/ea |
| JOR835K | 7.5mm | \$6.15/ea |
| JOR835M | 8.0mm | \$6.15/ea |
| JOR835N | 8.5mm | \$6.15/ea |
| JOR835P | 9.0mm | \$6.15/ea |
| JOR835Q | 9.5mm | \$6.15/ea |
| JOR835R | 10.0mm | \$6.15/ea |

Avian/Small Exotic Cole Endotracheal Tube

Perfect for the smallest of patients. Lower profile on the distal end aids in proper placement, and larger proximal end helps form a tighter seal. Stepped-down "Cole"-style wall. Silicon. Complete with attached standard 15mm connector.



JOR152A-152G



JOR152N & JOR152M

Oversized Small Animal Endotracheal Tube

Oversized Small Animal Endotracheal Tube. Gray PVC material with white inflatable cuff. Includes adaptor. 21" (52cm).



| | | |
|---------|-------------|------------|
| JOR835W | 11mm X 52cm | \$33.00/ea |
| JOR835X | 12mm X 52cm | \$33.00/ea |
| JOR835Y | 13mm X 52cm | \$33.00/ea |
| JOR835Z | 14mm X 52cm | \$33.00/ea |

| | | |
|---------|-------|------------|
| JOR152M | 1.0mm | \$18.00/ea |
| JOR152N | 1.5mm | \$13.20/ea |
| JOR152A | 2.0mm | \$21.00/ea |
| JOR152B | 2.5mm | \$24.00/ea |
| JOR152C | 3.0mm | \$24.00/ea |
| JOR152D | 3.5mm | \$24.00/ea |
| JOR152E | 4.0mm | \$30.00/ea |
| JOR152F | 5.0mm | \$16.50/ea |
| JOR152G | 6.0mm | \$15.00/ea |

13822 WEST BOULTON BLVD. METTAWA, IL 60045

WWW.SHOPMEDVET.COM

Phone 800-544-7521

309

Fax 800-204-2177

Anesthesia Products

Endotracheal Tubes

Jorvet Silicon Endotracheal Tube with Wire Reinforcement

Silicone is a great material for endotracheal tubes because it provides superior biocompatibility and flexibility. These tubes have a metal wire reinforcement that spirals the length of the tube. This reinforcement gives rigidity and prevents any possible occlusion.

Features:

- Graduations to aid in depth placement
- Radiopaque line for location confirmation
- Fully transparent to allow observation for development of blood or mucus
- Lateral Murphy eye
- 15mm connector included

Cuffed

| | | |
|---------|---------------------------------------|------------|
| JOR629E | 6.0mm i.d. 8.7mm/20fr o.d. 280mm L. | \$16.50/ea |
| JOR629F | 7.0mm i.d. 10.0mm/30fr o.d. 300mm L. | \$16.50/ea |
| JOR629G | 8.0mm i.d. 11.3mm/34fr o.d. 320mm L. | \$16.50/ea |
| JOR629H | 9.0mm i.d. 12.7mm/38fr o.d. 340mm L. | \$16.50/ea |
| JOR629J | 10.0mm i.d. 14.0mm/42fr o.d. 360mm L. | \$16.50/ea |

Un-Cuffed

| | | |
|---------|-------------------------------------|------------|
| JOR629A | 2.5mm i.d. 4.0mm/12fr o.d. 140mm L. | \$10.50/ea |
| JOR629B | 3.0mm i.d. 4.7mm/14fr o.d. 160mm L. | \$10.50/ea |
| JOR629C | 4.0mm i.d. 6.0mm/18fr o.d. 200mm L. | \$10.50/ea |
| JOR629D | 5.0mm i.d. 7.3mm/22fr o.d. 240mm L. | \$10.50/ea |

Equine Silicon Endotracheal Tube

Universal fitting allows connection to most large animal anesthesia machines and ventilators.

| | | |
|----------|--|----------|
| JOR151XA | 16mm i.d. 8cm L Balloon 70cm L Total | \$99.00 |
| JOR151XB | 18mm i.d. 8cm L Balloon 75cm L Total | \$113.00 |
| JOR151X | 20mm i.d. 10cm L Balloon 90cm L Total | \$156.00 |
| JOR151Y | 24mm i.d. 12cm L balloon 100cm L total | \$130.00 |
| JOR151Z | 30mm i.d. 14cm L balloon 100cm L total | \$204.00 |

Silicone Adhesive for Repair of Endotube Cuffs.

JOR151AT for repair of endotube cuffs, Must be purchased separately Must be purchased separately

Swine Extra-Long 8mm Silicon Endotracheal Tube

Especially designed with the cooperation of leading research centers for use in swine. Silicone. Graduated marking with standard adaptor, inflatable cuff, radio-paque, and lateral Murphy eye. Extra-long length. 8m i.d. x 18"(47cm).

| | | |
|---------|---|------------|
| JOR615X | 8mm i.d. x 18"(47cm) 8mm i.d. x 18"(47cm) | \$12.00/ea |
|---------|---|------------|



Jorvet

Cuff Repair Kit

| | | |
|------------|------|---------|
| JOR151YRC | 24mm | \$15.60 |
| JOR151ZRC | 30mm | \$16.00 |
| JOR151XARC | 16mm | \$11.20 |
| JOR151XCRC | 22mm | \$16.00 |
| JOR151YARC | 26mm | \$16.00 |

JOR151XA-JOR151Z

Jorvet



JOR151AT



JOR615X

Anesthesia Products

Endotracheal Tube Supplies

Jorvet Endotracheal Tube Stylet

Intubation is made easier when using a rigid stylet for the endotracheal tube. This stylet is a plastic coated malleable metal wire. One end has a rubber stopper that fits tightly over the endotracheal tube connector. It can slide to adjust for proper length. This stylet works especially well with silicon tubes that are less rigid than other tubes.

| | | |
|-----------|-----------------------------|-----------|
| JOR149STA | Fits Tubes Sizes 2.0-3.5mm | \$8.70/ea |
| JOR149STB | Fits Tubes Sizes 4.0-6.5mm | \$8.70/ea |
| JOR149STC | Fits Tubes Sizes 7.0-10.0mm | \$8.70/ea |

Jorvet Endotracheal Tube Cleaning Brush

| | | |
|---------|------------------------------|-----------|
| JOR151S | 8.0mm, cleans >= 8.0mm tubes | \$6.30/ea |
| JOR151Q | 4.0mm, cleans >= 5.0mm tubes | \$6.30/ea |

JorVet Endolight

New and improved, this small penlight has an attached flexible metal rod with a small wheat-head-size bulb. A small endotracheal tube 5mm easily slides over the rod. Gives rigidity and great illumination when intubating small dogs and cats. Makes a small keyhole task simple.

| | | |
|-----------|--|------------|
| JOR167Q | Operates on "AA" batteries (included). 10" shaft. Operates on "AA" batteries (included). | \$22.50/ea |
| JOR167QD1 | Bulb only | \$10.80/ea |

Jorvet Endotracheal Tube Rack

Attractive and convenient way to store up to 20 endotracheal tubes. The rack keeps tubes arranged by size for quick access in any emergency. It attaches easily to most wall surfaces by four adhesive strips or metal screws (included). 20" x 11" 4 lbs.

| | | |
|--------|---------------------|------------|
| JOR160 | 20" x 11", 20 Tubes | \$70.00/ea |
|--------|---------------------|------------|

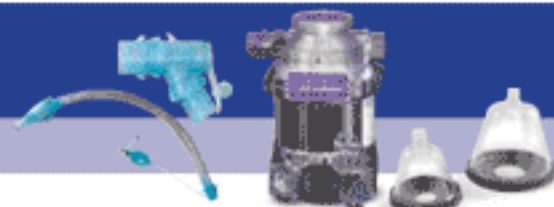

Jorvet Endotracheal Tube Adapter

Portex Endotracheal Adaptor The full range of small animal endotracheal tubes is covered by the twelve adaptors. The adaptors may be sterilized by conventional methods. The compact Swivel Connector may be rotated a full 360 degrees affording maximum positioning and flexibility. For use on all endotracheal tubes. 

| | | | | | |
|-----------|-------|-----------|----------|--------------|--------------|
| JOR157A | 2.5mm | \$2.25/ea | JOR157HH | 7.5mm | \$2.25/ea |
| JOR157AA | 3.0mm | \$2.25/ea | JOR157I | 8.0mm | \$2.25/ea |
| JOR157AAA | 3.5mm | \$2.25/ea | JOR157II | 8.5mm | \$2.25/ea |
| JOR157B | 4.0mm | \$2.25/ea | JOR157J | 9.0mm | \$2.25/ea |
| JOR157C | 4.5mm | \$2.25/ea | JOR157JJ | 9.5mm | \$2.25/ea |
| JOR157D | 5.0mm | \$2.25/ea | JOR157K | 10.0mm | \$2.25/ea |
| JOR157E | 5.5mm | \$2.25/ea | JOR157KK | 10.5mm | \$2.25/ea |
| JOR157F | 6.0mm | \$2.25/ea | JOR157L | 11.0mm | \$2.25/ea |
| JOR157G | 6.5mm | \$2.25/ea | JOR157T | 12.0mm | \$2.55/ea |
| JOR157H | 7.0mm | \$2.25/ea | JOR157 | Complete Set | \$65.00/ set |



Jorvet Swivel Connector

Swivel Connector. Allows movement between endotracheal tube and anesthesia circuit

| | | |
|---------|-----------|---|
| JOR157S | \$5.10/ea |  |
|---------|-----------|---|



One Way Valve for Endo Tube  **JOR157Z \$1.50/ea**

13822 WEST BOULTON BLVD. METTAWA, IL 60045

WWW.SHOPMEDVET.COM

Phone 800-544-7521

311

Fax 800-204-2177

Anesthesia Products

Connectors

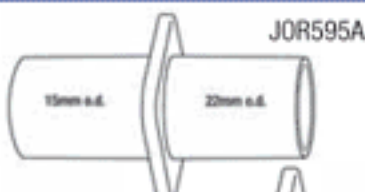

JOR595A



JOR595B

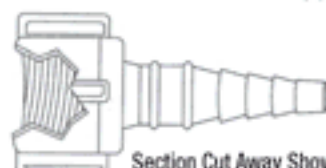

JOR595C

Section Cut Away Shows
Female DISS Threads

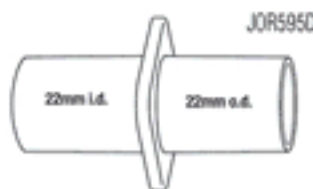

JOR595D

JOR595E

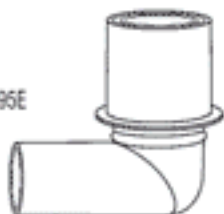

Jorvet Bacterial/Viral Filter

Filter fits onto a standard anesthesia circuit to remove possible pathogens. Bacteria/viral filtration 99.99%+ Dead space 42ml 22mm i.d. x 15mm i.d./22mm o.d. Individually packed. 3/pkg.

JOR756 Bacterial/Viral Filter 3/pkg \$16.20/ea

Primary Check Removal Tool

JOR537RT \$60.00/ea

Anesthesia Hose Connector Dual fitting polypropylene 2/pkg. **JorVet**

| | | |
|---------|---|-----------|
| JOR595 | 2 pack, Both ends 22mm/15mm x 22mm/19mm. | \$3.45/ea |
| JOR595A | 2 pack, 22mm o.d. x 15mm o.d. | \$4.05/ea |
| JOR595B | 2 pack, 15mm i.d. x 19mm o.d. x 22mm i.d. | \$4.05/ea |

Christmas Tree Connector

Dual fitting polypropylene. One end is a female DISS connector the other a barbed connector. One suggested use is from oxygen regulator connecting oxygen tubing to resuscitator bag. 2/pkg.

JOR595C 2/pkg 2 pk \$4.80/ea

Anesthesia Hose Adaptor 2/pkg

JOR595D 22mm i.d. x 22mm o.d. \$4.05/ea

JorVet

Anesthesia Elbow Connector.

Anesthesia Elbow Connector. **JorVet**

JOR595E 2/pkg. \$4.05/ea

Flush Valve **JorVet**

JOR595D9 \$52.00/ea



Jorvet Wye-Connector

Two legs fit standard 22mm anesthesia hoses, and third legs fits 15mm endotracheal tube connectors.

JOR249X Rigid \$2.10/ea
JOR249Y Swivel \$2.70/ea

JorVet



Humidification Management Exchanger **JorVet**

In human anesthesia the prevention of moisture and heat loss is a critical consideration. The smaller patient is especially a concern because hypothermia is more likely to occur. Humidification management exchangers are routinely used in human anesthesia. Veterinarians are starting to recognize the value of these products and make them part of their anesthetic regime.

The Humid-Vent is a compact connector that is a heat and moisture exchanger. They are placed in the breathing circuit between the "Y" piece (or "T" piece for non-rebreathing) and the endotracheal tube. Inside the connector is a special medium consisting of hygroscopic, naturally absorbent microwell paper. The Humid-Vent can be used up to 24 hours. After 24 hours they lose their effectiveness and must be replaced. In veterinary use they are typically replaced weekly. 5/box.

| | | |
|---------|--|------------|
| JOR606 | 0-11 lbs., 2.4ml, 10-50ml, 1.2cm H2O @ 7 lpm | \$51.00/ea |
| JOR606A | 11-75 lbs., 10.0ml, 50-600ml, 0.3cm H2O @ 20 lpm | \$26.40/ea |
| JOR606B | over 75 lbs., 25ml, 150-1500ml, 0.2cm H2O @ 20 lpm | \$42.00/ea |

Cage-Mounted Humidifier w/Flowmeter **JorVet**

This oxygen delivery system will attach to any cage.

- 15LPM flowmeter
- Bubble humidifier (JOR653) add water or saline
- Attaches to cage bars via two "U" bolts or wide flatwashers
- Choices of male DISS fitting or male Ohio quick release for oxygen hose connection to flowmeter
- Oxygen tubing 7 ft (JOR655) Oxygen catheter 14ft (JOR656) for nasal insertion of "blow by"

JOR953 Male DISS fitting \$154.00/ea
JOR9530 Male Ohio quick release \$154.00/ea

Oxygen Divider **JorVet**

JOR948D \$12.00/ea

Nasal Cannula for Oxygen Administration **JorVet**

HCS4511 Adult, 50/case \$25.38/cs

Get A FREE US Savings Bond with your next order
See inside cover for details



13822 WEST BOULTON BLVD. METTAWA, IL 60045

WWW.SHOPMEDVET.COM

Phone 800-544-7521

312

Fax 800-204-2177

Anesthesia Products

Nebulizer & Oxyhood



Feline Breathe Easy Inhalant Delivery System. **Jorvet**

A great aid in treating feline asthma has been improved! The "Feline Breathe Easy" has been a very popular product in treating feline asthma. The pocket spacer holds a metered dose inhaler (MDI) to deliver medication.

1. The new pocket spacer is called the Vortex and has three advantages over other plastic pocket spacers:
2. Anodized Aluminum chamber versus plastic. The anodized aluminum is non-electrostatic and delivers more medication from the MDI to the patient.
3. "Duckbill" shaped valve designed for minimal aspiratory effort, ensures a low loss of medication.
4. Vortex Cyclonic aspiratory flow pattern enhances aerosol delivery.

JOR843 \$37.50/ea



Pocket Spacer

JOR843D1 \$30.00/ea



JOR653



Jorvet Oxyhood

The challenge of delivering oxygen to an animal in respiratory distress is difficult in most veterinary clinical situations. An oxygen cage or an ICU unit is an expense beyond the budget of most clinics. The hand held use of anesthesia masks or nasal cannula is stressful to the animal and labor intensive. The Oxy Hood was developed to deliver oxygen in a less restrictive and stressful environment. The Oxy Hood uses the conventional cone shape of an Elizabethan collar and adds a clear plastic "lid" over the end. Numerous vent holes throughout the cone allows the excess gas to vent. Oxygen is provided to the Oxy Hood via a nasal cannula attached to the hood. The oxygen source uses a bubble humidifier to prevent drying of the respiratory tract.

Features:

- Collar is sewn to nylon fabric with a drawstring, plus velcro attachment allows for proper neck sizing
- Lid, or face of unit is attached with zipper
- Clear plastic material is used throughout for better observation and for the animal to see clearly
- Four sets of holes die cut to allow ventilation of carbon dioxide and to maintain the oxygen level at more than 60 percent
- Very small animals can be placed totally in the larger Oxy Hood like an oxygen tent
- Complete with humidifier, oxygen nasal cannula, and oxygen tubing

| | | |
|---------|------------------------------|-------------|
| JOR652A | Small. Cats and dogs 15 lbs. | \$46.50/ea |
| JOR652B | Medium. Animals 15-30 lbs. | \$57.00/ea |
| JOR652C | Large. Animals 30-60 lbs. | \$70.50/ea |
| JOR652S | Set of all 3 sizes. | \$154.00/pk |

Nebulizer Compressor M08

Nebulizer compressor unit with complete accessories. Uses room air to power a medicated nebulizer. Takes about 10 minutes. Mask not included. Uses 110V Size

JOR949M 16.2" x 3.9" x 6.9". Weight 3.5 lbs. \$115.00/ea

Micromist Nebulizer w/Tee, Tubing and Mouthpiece

JOR949X Micro-mist and T only \$5.70/ea

Medicated Nebulizer 9cc

JOR949N \$6.30/pk **Jorvet**

Air Filters, 12pk (for JOR949)

JOR949D2 \$12.00/dz **Jorvet**



Nebulizer/Compressor

This new sleek design is easy to pick up with break resistant hinges. It remains stable when laying flat on four non-skid rubber feet due to its low center of gravity. Requirements: 115 VAC / 60 Hz; Power Con

HCS60004 Compact size with initial circuit \$45.00/ea

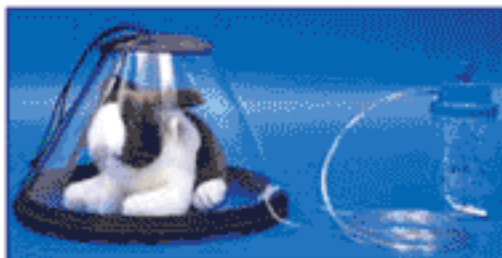

Oxygen Nasal Cannula (4 pack)

This clear tubing delivers oxygen via small plastic tubing to two outlets designed to lay just outside the nares. With universal female connector (i.e. will fit DISS fitting of a flowmeter).

JOR654 \$6.00/pk **Jorvet**



Jorvet Oxygen Catheter

Clear plastic catheter with round tip and side ports for intra-nasal oxygen therapy. Connects to oxygen tubing. (not pictured)

JOR656 14Fr x 16" (4 pack) \$9.00/pk
 JOR656A 16"L x 10fr dia. 4/pk. \$9.00/pk

Jorvet Oxyhood Connector

JOR652Q \$6.15/ea **Jorvet**

Jorvet Oxygen Supply Tubing

Clear plastic with universal female connectors that can connect to DISS male fittings.

JOR655L 25 ft. (2 pack) \$9.30/pk
 JOR655 25 ft. (2 pack) \$8.70/pk

Jorvet Humidifier

This device works by oxygen bubbling through a diffuser in a fluid.

JOR653 \$5.25/ea **Jorvet**



13822 WEST BOULTON BLVD. METTAWA, IL 60045

WWW.SHOPMEDVET.COM

Phone 800-544-7521

313

Fax 800-204-2177

Anesthesia Products

Laryngoscope Handles and Blades

Laryngoscope Handle

| | | |
|-------|-------------------------|------------|
| LAR-S | Small (Uses AA Battery) | \$12.80/ea |
| LAR-M | Medium (Uses C Battery) | \$12.80/ea |



Laryngoscope Handle **JorVet**

Special Penlight Handle only. Works great for cats.

| | |
|---------|------------|
| JOR449P | \$30.00/ea |
| JOR449M | \$30.00/ea |



Handle Only

Laryngoscope Blades.

Miller Laryngoscope Blade

Straight shaft with gentle curved tip.

| | | |
|---------|------------|------------|
| JOR449A | 53mm | \$54.00/ea |
| JOR449B | 80mm | \$54.00/ea |
| JOR449C | 130mm | \$54.00/ea |
| JOR449D | 173mm | \$54.00/ea |
| JOR449E | 180mm | \$54.00/ea |
| JOR449F | 12" Length | \$84.00/ea |

JOR449A



JOR449B



JOR449C



JOR449D

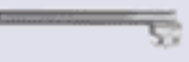

JOR449E



McIntosh Laryngoscope Blade

Curved along entire length of blade. **JorVet**

| | | |
|----------|------------|------------|
| JOR449AM | 60mm | \$39.00/ea |
| JOR449BM | 66mm | \$39.00/ea |
| JOR449CM | 85mm | \$39.00/ea |
| JOR449DM | 110mm | \$39.00/ea |
| JOR449EM | 140mm | \$39.00/ea |
| JOR449F | 12" Length | \$84.00/ea |

JOR449AM



JOR449BM



JOR449CM



JOR449DM

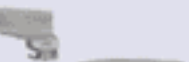

JOR449EM

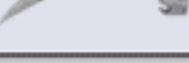

Laryngoscope Bulbs

Laryngoscope Bulb

| | | |
|------|-------|-----------|
| 5336 | Small | \$3.99/ea |
| 5337 | Large | \$3.99/ea |



Macintosh Laryngoscope Blade

Med-Vet features two different types of laryngoscope blades.

These high quality laryngoscope blades are made from the finest surgical grade stainless steel and come complete with standard lamps.

| | | |
|-------|--------|------------|
| MAC-0 | Size 0 | \$19.95/ea |
| MAC-1 | Size 1 | \$19.95/ea |
| MAC-2 | Size 2 | \$19.95/ea |
| MAC-3 | Size 3 | \$19.95/ea |
| MAC-4 | Size 4 | \$19.95/ea |



Miller Laryngoscope Blade

These high quality laryngoscope blades are made from the finest surgical grade stainless steel and come complete with standard lamps.

| | | |
|-------|----------------|------------|
| MIL-0 | Size 0 | \$19.95/ea |
| MIL-1 | Size 1, 80 mm | \$19.95/ea |
| MIL-2 | Size 2, 130 mm | \$19.95/ea |
| MIL-3 | Size 3, 173 mm | \$19.95/ea |
| MIL-4 | Size 4, 180 mm | \$19.95/ea |



Laryngoscope Kit **JorVet** (6 blades w/ med.handle)

A handy kit in a black leatherette zipper pouch.

- Includes:
- 3 Macintosh blades #1, #2, and #4
 - 3 Miller blades #1, #2, and #4
 - 1 medium handle

JOR449S \$279.00/ea



Laryngoscope Replacement Light Bulb

Long Bulb. Used for JOR449b through JOR449f and JOR449bm through JOR449em blades. Sizes 12 mm and 6mm.

JOR449RL \$9.00/ea **JorVet**

Short Bulb. Used for JOR449a through JOR449am blades. Sizes 10mm and 3mm.

JOR449R \$7.50/ea **JorVet**

Anesthesia Products

Anesthesia Circuits



Jackson Rees Anesthesia Circuit

Modified Jackson Rees Circuits Non-rebreathing circuit. This model has a side vent above the bag and is closed by sliding an on/off button for "bagging an animal." Bag does not have a tail bleed on its end. Complete circuit w/ 1-liter bag

| | | |
|---------|--------------------------|------------|
| JOR248G | Jackson Rees With 1L Bag | \$18.00/ea |
|---------|--------------------------|------------|

Disposable Adult Anesthesia Circuit

Adult disposable anesthesia breaking circuit consists of two 40" breathing tubes (7/8"), inhaler "Y" and mask elbow. natural color

| | | |
|---------|-------------------|------------|
| JOR248D | With 3 Ltr Bag | \$13.50/ea |
| JOR248C | Without 3 Ltr Bag | \$10.35/ea |

Disposable Ayers Non-Rebreathing Circuits

Disposable Ayers Non-Rebreathing Circuits. For very small patients (under 10 lbs) who cannot use rebreathing systems due to dead space complications.

| | | |
|----------|-------------------------------|------------|
| JOR248E | 1/2L Bag | \$19.80/ea |
| JOR248EA | 1L Bag, with Tail Bleed Valve | \$23.40/ea |

Esophagostomy Tube

| | | |
|--------|------------------------|-----------|
| JOR390 | 14fr x 9" Not Pictured | \$7.20/ea |
|--------|------------------------|-----------|

Universal "F" Anesthesia Circuit

This is the popular uni-limb circuit that is a tube within a tube circuit.

Features:

- One 40" hose for lighter weight and maneuverability around the patient's head.
- Exhaled gas warms up incoming fresh gas.
- Attaches to any standard anesthesia machine.

| | | |
|----------|------------------|------------|
| JOR248FL | 60" hose 2 liter | \$30.00/ea |
|----------|------------------|------------|

Adult Universal "F" Anesthesia Circuit



This is the popular uni-limb circuit that is a tube within a tube circuit. Includes one 40" hose for lighter weight and maneuverability around patients head. Exhaled gas warms up incoming fresh gas. Attaches to any standard anesthesia machine.

| | | |
|----------|-------------|------------|
| JOR248F | With 2L Bag | \$24.00/ea |
| JOR248FA | Without Bag | \$24.00/ea |

Universal "F" Anesthesia circuit



| | | |
|-----------|------------------|------------|
| JOR248FLA | 60" Hose w/o Bag | \$24.00/ea |
|-----------|------------------|------------|

Pediatric "F" Anesthesia Circuit



| | | |
|-----------|------------------|------------|
| JOR248KLA | 60" Hose w/o Bag | \$21.00/ea |
|-----------|------------------|------------|

Pediatric Universal "F" Anesthesia Circuit



For animals weighing 4kg 20kg.

Features:

- Smaller diameter tubing with less dead space than standard uni-limb system
- Pink colored inner tubing 40"
- One 40" hose



| | | |
|----------|------------------|------------|
| JOR248KL | 60" Hose 2 Liter | \$27.00/ea |
|----------|------------------|------------|

Pediatric Universal "F" Anesthesia Circuit



For smaller animals weighing between 4kg and 20kg. Includes a smaller diameter tubing with less dead space than the standard uni-limb system. Pink inner tubing.

| | | |
|----------|-------------|------------|
| JOR248K | With 1L Bag | \$24.00/ea |
| JOR248KA | Without Bag | \$18.00/ea |

Disposable Pediatric Anesthesia Circuit



For use with smaller patients, this lessens the amount of dead space. Consists of two 30" breathing tubes (5/8"), inhaler "Y" piece and mask elbow. Clear color.

| | | |
|---------|--------------------|------------|
| JOR248A | Without 1 Ltr. Bag | \$10.80/ea |
| JOR248B | With 1 Ltr Bag | \$12.75/ea |



Laboratory Equipment & Supplies

Blood Collection, Tubes & Centrifuges



Blood Collection Tube Red Top

Serum tubes have spray-coated silica and are used for serum determinations in chemistry, serology, and immunohematology.

| | | |
|---------|------------------------|------------|
| RED3.0 | 3/4ml Red Plain 100/bx | \$17.50/bx |
| RED5.0 | 5ml Red Plain 100/bx | \$19.50/bx |
| RED7.0 | 7ml Red Plain 100/bx | \$19.95/bx |
| RED10.0 | 10ml Red Plain 100/bx | \$19.50/bx |



Serum Separation Tubes

Tubes contain spray-coated silica and a polymer gel for serum separation. They are used for serum determinations in chemistry. Tubes provide an efficient means of serum sample preparation and help to improve laboratory workflow.

| | | |
|--------|----------------------|------------|
| SST6.0 | 5/6ml SST 100/bx | \$32.00/bx |
| SST8.5 | 8.5/9.5ml SST 100/bx | \$34.00/bx |
| SST4.0 | 4ml SST 100/bx | \$30.00/bx |



Blood Collection Tube EDTA

Spray-coated EDTA Tubes are used for whole blood hematology determinations and immunohematology testing.

| | | |
|--------|----------------------|------------|
| LAV2.0 | 2ml Lav. Edta 100/bx | \$16.00/bx |
| LAV3.0 | 3ml Lav. Edta 100/bx | \$16.00/bx |
| LAV4.0 | 4ml Lav. Edta 100/bx | \$16.00/bx |
| LAV7.0 | 7ml Lav. Edta 100/bx | \$24.21/bx |



Wire Test Tube Rack

Tough. Corrosion-resistant. Epoxy coated. Three-layered deck with square holes. Holds 72 tubes in a 6 x 12 configuration. Measurements: 2 5/8" tall x 5 1/8" wide x 9 1/2" long.

| | | |
|--------|------------------------|------------|
| JOR352 | 6 X 12, holds 72 Tubes | \$36.90/ea |
|--------|------------------------|------------|

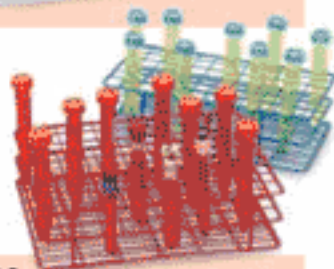

Blood Collection Set

| | | |
|------|---------------|-----------|
| 7283 | 23 x 3/4 each | \$0.50/ea |
|------|---------------|-----------|

Full View Test Tube Supports and Dry Rack Combined

Tubes can be stored upright full or empty or can be inverted over pins for drying. Polypropylene. Steam autoclavable. 50 tube places in 5 x 10 configuration. 66 drying pins.

| | | |
|---------------------|-----------------------------------|------------|
| JOR352D | 10cm W x 18cm L x 6.7cm H. White. | \$40.60/ea |
| Tubes not included. | | |

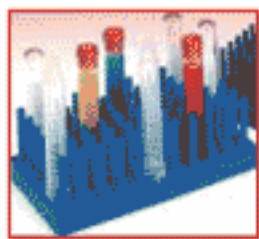

Universal Cap for Test Tubes

This cap will work on almost all laboratory test tubes. It will fit 12mm, 13mm, and 16mm test tubes. Note JOR546A 15ml, centrifuge tube has a 16mm diameter opening.

| | | |
|---------|--------------------|-----------|
| JOR546C | Green color. 100pk | \$6.15/ea |
|---------|--------------------|-----------|

Screw Cap Test Tube

| | | |
|---------|------|---------|
| JOR547A | 16ml | \$24.00 |
|---------|------|---------|



Test Tube Pack with Color Comparator

The white surface background aids in test tube evaluation or comparison. Holds up to 14 tubes of various sizes and has 6 drying pins.

| | | |
|---------|--------------------------|------------|
| JOR352E | 4 1/2"W x 8"L x 3 1/2"H. | \$24.60/ea |
|---------|--------------------------|------------|

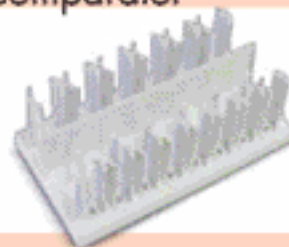

Heartworm Rack

Commonly used for heartworm testing. Holds 72 micro-sample tubes.

| | | |
|---------|---------------------------|------------|
| JOR352H | 8 3/8" x 3 3/8" x 4 3/8". | \$45.00/ea |
|---------|---------------------------|------------|



Acrylic Blood Tube Rack

Organize your blood collection tubes. This rack can hold over 200 tubes in various compartments. Separate tubes by color and size. It can be wall mounted or placed on a counter top.

| | | |
|--------|-----------------------|------------|
| JOR885 | 12"W x 16"H x 5 1/2"D | \$93.00/ea |
|--------|-----------------------|------------|

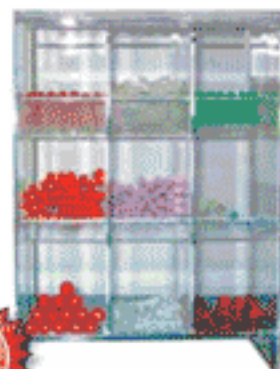

Test Tube Rocker

Its gentle back and forth motion is designed to protect blood samples from clotting before they can be evaluated. Ideal for blood collection tubes. Smooth mixing action for consistent uniform specimen suspension.

| | | |
|--------|--|-------------|
| JOR819 | Large Blood Rocker, Holds 16 tubes. 13 3/4" x 4 1/3" x 5 1/2". 5 1/2 lbs. | \$366.00/ea |
|--------|--|-------------|

| | | |
|---------|--|-------------|
| JOR819A | Small Blood Rocker, Holds 8 tubes. 7 1/2" x 4 1/3" x 5 1/2". 3 lbs. | \$470.00/ea |
|---------|--|-------------|

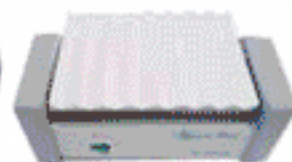

Rubber Tube Cushion

| | | |
|----------|--------------|-----------|
| JOR501TC | Cushion Only | \$3.00/ea |
|----------|--------------|-----------|





Twirl'em Pack

The affordable sterile container. Ideal for transport of solids, semi-solids, or liquids. Similar to Whirl paks.

- Heavy-gauge transparent polyethylene
- Double bottom seam
- Can write on printed surface
- 3" x 7" (76mm x 127mm)
- 4 oz. (120ml) capacity
- 100/case



JOR557 3" x 7", 100-pack \$18.60/pk



Pipette Tips

Tips are manufactured using high quality raw materials and the latest molding techniques and are designed using the knowledge of liquid handling.

A18 2-13/16" 250/BX \$4.99/bx

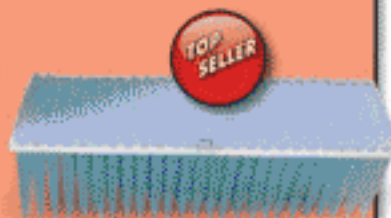

Plastic Graduated Transfer Pipettes

Made of low-density polyethylene, non-sterile, graduated. These unbreakable all-in-one pipettes eliminate the hazards of broken glass and exposure to infectious materials.

PTP-01 3ml graduations, 7ml capacity, 500/box \$15.80/bx

PTP-02 1ml graduations, 5ml capacity, 500/box \$15.80/bx



Infusion Pipettes

High quality PVC pipette with rounded polished insertion end to prevent tissue trauma. Large bore, manufactured with the following specifications; 0.160 i.d. x 0.225 o.d. for infusing viscous fluids. All tubes 25/poly bag.

| | | |
|---------|---------------------------|------------|
| JOR287A | 18", flex adaptor, 25 pk. | \$7.65/pk |
| JOR287B | 18", drilled, 25 pk. | \$5.70/pk |
| JOR287C | 21", flex adaptor, 25 pk. | \$8.25/pk |
| JOR287D | 21", drilled, 25 pk. | \$5.70/pk |
| JOR287E | 21", drilled, sterile | \$15.90/bg |
| JOR287F | 21", flex adaptor | \$18.00/bg |



Fixed Volume Pipettor

Pipettors are widely used in laboratories. They are an accurate method of transferring solutions or reagents. They also reduce exposure to samples or laboratory chemicals. Consisting of two parts, a reusable pipettor draws up fluid through the disposable tip which actually holds the fluid in a preset, precise volume. The fluid never reaches or touches the actual pipettor. The disposable pipettes cost only pennies and are discarded after each use. Pipettors are available in either fixed or adjustable volume. Adjustable Volume Pipettor. 200/pk.

- Easy volume setting by simply turning the plunger
- Streamlined tip for access to narrow containers and tubes

| | | |
|---------|---------------|-------------|
| JOR856 | 0.05ml 200/pk | \$129.50/pk |
| JOR856A | 0.10ml 200/pk | \$196.00/pk |
| JOR856B | 0.50ml 200/pk | \$129.50/pk |
| JOR856C | 1.00ml 200/pk | \$146.00/pk |



Jorvet Pipette Tips

| | | |
|---------|---------------------|------------|
| JOR857A | 1ml, 500pk | \$16.80/pk |
| JOR857B | 5ml capacity, 300pk | \$45.00/pk |

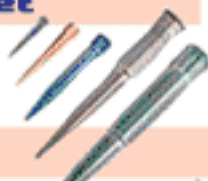

Extra-Large Bore Pipettes

1/4" x 25". Non-sterile. 25/bag.

| | | |
|---------|-------------------|------------|
| JOR286P | Non-Sterile, 25pk | \$25.50/pk |
| JOR286S | Sterile, 25-pk | \$35.10/pk |



Disposable Transfer Pipettes

General laboratory use from serum to urine. Single use clean polyethylene. Three sizes available.

| | | |
|---------|--|------------|
| JOR353 | 7.0ml Pipette. 6"L. 22 drops/ml. Graduations up to 3ml. 50/pk. (Most popular size.) | \$9.90/bg |
| JOR353A | 7.0ml Pipette. 6"L. 22 drops/ml. Graduations up to 3ml. 500/pk. (Most popular size.) | \$27.30/bx |
| JOR353B | 3.0ml Pipette. 5 1/2"L. 25 drops/ml. Graduations up to 1 ml. 50/pk. | \$4.80/pk |
| JOR353C | 3.0ml Pipette. 5 1/2"L. 25 drops/ml. Graduations up to 1 ml. 500/pk. | \$31.80/pk |
| JOR353D | 1.7ml Pipette. 3 1/2"L. 25 drops/ml. No graduations. 50/pk. | \$5.10/pk |
| JOR353E | 1.7ml Pipette. 3 1/2"L. 25 drops/ml. No graduations. 500/pk. | \$28.80/pk |



Jorvet Mini Pet Pipette

Deliver precise and accurate volumes of lab samples through an inexpensive, reusable pipettor. Constructed of durable molded colorful plastic that performs nicely for routine clinical lab procedures that requires specific volumes delivered.

JOR354 The MiniPets pipettors use the 0.2ml capacity disposable pipettes. \$99.00/ea



Adjustable Volume Pipettor

| | | |
|---------|--------------------------|-------------|
| JOR855 | 0.02-0.20ml (20-200ul) | \$194.00/ea |
| JOR855A | 0.20-1.00ml (200-1000ul) | \$196.00/ea |
| JOR855B | 1.00-5.00ml | \$196.00/ea |



Jorvet 3 Corner Beaker

These graduated beakers are unbreakable polypropylene with built-in pour spouts. Not affected by most chemicals. Beakers are inexpensive enough to be disposable but can be autoclaved and/or reused.

| | | |
|---------|-----------------|------------|
| JOR168 | 50ml, 10 pack | \$5.25/pk |
| JOR168A | 400ml, 10 pack | \$8.40/pk |
| JOR168B | 1000ml, 10 pack | \$12.00/pk |



Sterile Disposable Specimen Container

Graduated specimen container. A leak proof lid. Wide base for stable reliable use. Seal/label assures internal sterility. Green cap.

JOR555 4 oz., (120ml), 100/bag. \$27.60/bg



Laboratory Equipment & Supplies

Microscope Accessories & Hemacytometer System

Kimwipe (KIMTECH)

KIMTECH SCIENCE KIMWIPES Delicate Task Wiper, 3 ply, POP-UP Box, offers a unique combination of low-lint tissue softness and multi-ply absorbency that's perfect for a multitude of delicate tasks. Kimwipes have multi-ply absorbency, wipes up liquid and dust.

- Delicate task wipers wipe clean with extra low-lint and extractable performance.
- The Industry Standard for Labs and Research
- KIMTECH SCIENCE KIMWIPES Wipers are a versatile option for delicate tasks such as laboratory cleaning, surface/parts cleaning, instrument cleaning and lens cleaning.

34743 12" X 12", 119/bx \$8.95/bx



Jorvet Immersion Oil

Used in high power magnification

JOR326A 120ml bottle \$15.60/btl



"No-Residue" Microscope Lens Cleaning Solution

1 oz. dispensing bottle. **Jorvet**
Removes dried residue from objectives.

JOR869S Use with JOR869 lens tissues. \$9.00/ea



Lint-Free Lens Paper

Tissues. Special grade pop-up sheets remove oil immersion that collects and dries on objectives.

JOR869 3" x 4 1/2" x 4 1/2". 280/box. Similar to Kim Wipes. \$4.95/ea



Kim Wipes Acrylic Box Holder

Out of your way, but still at your fingertips. Mount Kim Wipes on the wall with these acrylic holders. Easily attaches with double back tape.

JOR877 130mm x 84mm x 122mm \$16.80/ea



Cadaver Bags **Jorvet**

Heavy-duty 4 ml black plastic. Strong enough to handle the sanitary disposal of animals. Full 35" x 48". 25 bags/pk. (not pictured)

JOR108 25 pack \$28.00/pk

Dose Adaptor

Fits all standard luer lock and luer tip syringes.

JOR206 4" \$8.10/ea



Microscope Cleaning/Service Kit

This kit will work for any and all microscopes. The microscope is a workhorse in the veterinary clinic. It is routinely exposed to many solutions between laboratory stains, immersion oils, and body fluids. These all can adversely affect the optical performance. Routine cleaning, adjustment, and alignment are a necessary function to get the best diagnostic quality images from your microscope. This job is difficult without the proper tools and instructions. The Jorvet microscope cleaning and service kit makes this possible for even the novice microscope user. The kit contains ten different components in a storage case.

- Micro-fiber lens cloth that removes dust and debris from the scope (9" x 9")
- Soft-bristled dusting brush for routine removal of dust and debris
- Set of 3 Allen Wrenches: 1.5mm, 2.0mm, 2.5mm
- Micro-glide gear lubricant
- Precision screwdriver set (5) for very small microscope screws
- Air duster 8 oz. pressurized aerosol can with exterior tube
- Cotton tip applicators (100) for cleaning objectives
- Friction collar small double-sided wrench
- Black nylon zippered storage case. 4" x 7" x 10". 1.9 lbs.
- Detailed illustrated service manual, and a glossary of common microscope terminology

JOR869K \$76.00/ea



Microscope Accessories Custom Organizer

Organizer. A wide variety of items accumulate around a microscope station: slides, pipettes, lens paper, cleaning solutions, immersion oil, and cover slips, etc. These all can be organized in an attractive, clear acrylic display of divider boxes. Each divider box has double-sided foam tape for custom attachment to the central station.

JOR869X 11"W x 14"L x 11"H \$120.00/ea



Cell-VU Hemacytometer System Kit

The safety hemacytometer system for use with all manual-counting procedures.

Sperm • CSF • WBC • Urine

Consists of both the slide and cover slips

Slide is dual chambered providing for two determinations per sample

Cover slips are laser-etched grid that is easy to view

JOR821X Each system consists of: 3 slides with dual chamber and 6 cover slips with etched grid Directions for sperm concentration included. \$24.00/pk

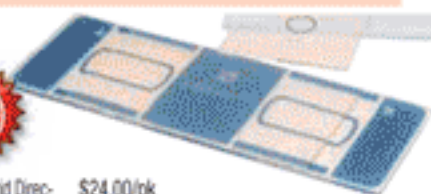

Jorvet Neubauer Hemacytometer

Designed especially for counting blood cells with the "unopette." Double rulings are visible through a wide range of illumination. Neubauer rulings are 0.1mm below cover glass. The "H"-shaped moat offers two counting areas. Fused rhodium on glass provides distinct lines.

JOR821 Fused rhodium on glass provides distinct lines. \$129.00/ea



Lab Eartag Applicator

Has specially designed head where tag slips in easily. Allows for quick and simple placement of tag in ear.

JOR49LTA \$92.00/ea



Jorvet Lab Eartags

These small numbered tags are used extensively in research institutions around the world. The small metal brass tags are perfectly suited for mice and rats. They are easy to apply with metal applicator. (JOR49Lta) Choose numbers 1-10,000. 100/box.

JOR49LT 100 pk. \$36.00/pk



13822 WEST BOULTON BLVD. METTAWA, IL 60045

WWW.SHOPMEDVET.COM

Phone 800-544-7521

318

Fax 800-204-2177

Microscope Slides & Accessories

Microscope Slides

Pre-cleaned, high quality glass. Hard, colorless, non-corrosive. Ground, polished edges. 1" X 3" 72 per box.

| | | |
|------------|----------------|-----------|
| MICROFROST | Frosted, 72/bx | \$2.49/bx |
| MICROPLAIN | Plain, 72/bx | \$2.49/bx |

Microscope Slide

High-quality glass slide that will serve every clinical lab need from permanent mounts to fecal samples.

- Slides individually separated by thin tissue paper to prevent sticking together.
- Smooth edges with beveled corners
- 1" x 3" x 1.2mm (1/25") thick (frosted)

| | | |
|---------|-------------------------------|-----------|
| JOR335F | Frosted Edge, 1" x 3", 72/box | \$4.40/bx |
| JOR335 | Clear, 1" x 3", 72/box | \$3.30/bx |

Cover Glass

Microscope cover glass 1 oz. box #1 thickness 22mm X 22mm

| | | |
|------------|-------------|-----------|
| COVERGLASS | 22mm x 22mm | \$2.50/bx |
|------------|-------------|-----------|

Glass Cover Slips

Ultra-thin glass. 22mm x 22mm (~1" x ~1"). 100/Box.

| | | |
|--------|---------|-----------|
| JOR336 | 100/box | \$2.95/bx |
|--------|---------|-----------|

Hemocytometer Coverslip

| | | |
|---------|------|------------|
| JOR821C | each | \$10.50/ea |
|---------|------|------------|

Plastic Coverslips

Almost unbreakable flexible vinyl cover slip. Interleaved with tissue. 22mm W x 22mm L x 0.157mm (0.007") H. 100/box.

| | | |
|---------|-------|-----------|
| JOR336P | 100pk | \$8.25/pk |
|---------|-------|-----------|



McMaster Egg Worm Slide

Special microscope slide with two etched chambers for quantitative fecal analysis.

| | | |
|---------|-------------------------|------------|
| JOR335M | McMaster Egg Worm Slide | \$63.00/ea |
|---------|-------------------------|------------|

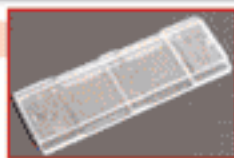

Microscope Slide Holder

These sturdy cardboard slide mailers are designed for safe, easy handling of microscope slides. Reusable

- Holds standard 1" x 3" (2.5mm x 7.6cm) slides with or without cover slip
- Inner groove for easy finger removal
- Extra area for labeling information

| | | |
|---------|---------------|------------|
| JOR337L | for 20 Slides | \$15.30/ea |
|---------|---------------|------------|



Jorvet Slide Storage and Index Box

Provides safe storage. This slide holder set includes twelve 5" x 3" cards. You can sort, group, classify or arrange slides in any order. Each holder consists of a white plastic frame adhered to an index card. They hold 4 slides per card. Index tabs allow for reference and classification. File box constructed of sturdy gray plastic.

| | | |
|---------|------------------------------------|------------|
| JOR816S | Set includes twelve 5" x 3" cards. | \$16.50/ea |
|---------|------------------------------------|------------|



Slide Box

Microscope Slide Box; Fisherbrand; Holds 3 x 1 in. or 75 x 25mm slides. Molded-hinged Living lid. Printed index card included. Numbered slots. Capacity: 100 slides.

| | | |
|--------|-----------|-----------|
| 034481 | 100 place | \$9.95/ea |
|--------|-----------|-----------|



Slide Holder

Details: Sturdy ABS plastic box with our exclusive self locking lid holds up to 25 slides and has cork lined bottom. Index paper in lid corresponds with embossed numerals on bottom of box.

| | | |
|-------------|-----------|-----------|
| SLIDEHOLDER | 25 Slides | \$1.20/ea |
|-------------|-----------|-----------|



Jorvet 2-Place Slide Mailer

These two place slide protectors hold standard microscope slides securely. With large, easy to secure snaps, our propylene mailers provide safe storage for valuable slides. Bright neon assorted colors (red, yellow, blue, purple, and orange) are great for color-coding. Inexpensive. 93mm W x 68mm L x 5 mm H. 25/pk assorted colors.

| | | | |
|---------|------|------------|---------------|
| JOR337A | 25pk | \$19.50/pk | Jorvet |
|---------|------|------------|---------------|

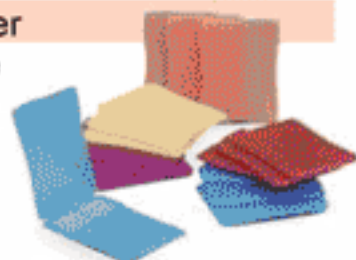

Jorvet Plastic 5-Slide Mailer

Ideal for shipping, storing or staining of slides. These polypropylene containers hold five standard slides. Hinged side opening with secure closure. Slotted channels for slide separation and easy removal.

| | | | |
|---------|-----------------------|------------------------|-----------|
| JOR816X | 5/pk. Assorted colors | Plastic 5-Slide Mailer | \$5.70/pk |
|---------|-----------------------|------------------------|-----------|

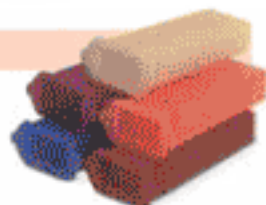

Microscope Slide Box

Each box has slots for each slide. A foam back secures slides. Closes via a clasp and hinge. A chart on inside cover allows for written record of each specific slide.

| | | |
|---------|---|------------|
| JOR816R | 100-Place Slide Box. Blue. 8 3/4" x 6 3/4" x 1 3/8" | \$16.20/ea |
| JOR816T | 25-Place Slide Box. Red. 5 1/2" x 3 1/2" x 1 1/4" | \$8.70/ea |



Jorvet Dual Microscope Slide Holder

These sturdy cardboard slide mailers are designed for safe, easy handling of microscope slides. Reusable Holds standard 1" x 3" (2.5mm x 7.6cm) slides with or without cover slip Inner groove for easy finger removal. Extra area for labeling information

| | | | |
|--------|--------|-----------|---------------|
| JOR337 | 2 Pack | \$4.50/pk | Jorvet |
|--------|--------|-----------|---------------|



Microscope Slide Dispenser

ABS plastic dispenser releases clean, dust-free microscope slides. Holds 72 standard slides. Turning either side wheel dispenses slides out one at a time. Unique design makes loading of microscope slides very easy. The clear plastic cover allows one to see number of slides remaining.

| | | |
|--------|--------------------------|------------|
| JOR815 | Holds 72 standard slides | \$24.00/ea |
|--------|--------------------------|------------|





Acid Fast Stain **Jorvet**

A very useful, specialized stain. Use for identification of: Johnes disease, cryptosporidium, acid fast organisms. 126ml bottle.

| | | |
|------------|----------|------------|
| JOR326AS | Kit | \$45.90/ea |
| JOR326ASD1 | Stain #1 | \$9.60/ea |
| JOR326ASD2 | Stain #2 | \$9.60/ea |
| JOR326ASD3 | Stain #3 | \$9.60/ea |
| JOR326ASD4 | Stain #4 | \$9.60/ea |



Methanol **Jorvet**

Hazard material, can only ship ground.

| | | |
|------------|--|-----------|
| JOR326ASDA | | \$7.50/ea |
|------------|--|-----------|

Jorvet Dip Quick Stain **Jorvet**

Excellent for use in blood cell differential counts or as a general cytology stain, and gives coloration similar to the standard Wright-Giemsa stain. The rapid 3-step procedure can be done right in the wide-mouth 180ml. container in 15 seconds.

| | | |
|---------|----------------|------------|
| JOR322 | Complete kit | \$33.30/ea |
| JOR322A | Refill 3x500ml | \$54.00/ea |

Individual Refills

| | | |
|-----------|------------------------|-------------|
| JOR322A1 | #1 Fixative 500ml | \$22.20/ea |
| JOR322A2 | #2 Eosin 500ml | \$23.70/ea |
| JOR322A3 | #3 Counter stain 500ml | \$25.50/ea |
| JOR322A2G | Gallon | \$98.00/gl |
| JOR322A3G | Gallon | \$106.00/gl |



Jorvet Gram Stain **Jorvet**

An important stain that has a multitude of uses, i.e., a quick diagnostic check on a swab from a severe otitis or a stain from an isolated culture. 4 x 250ml bottles

Jorvet

| | | |
|----------|-------------------------------|------------|
| JOR323 | Kit, 4 x 250ml | \$27.60/ea |
| JOR323D1 | Crystal Violet, 250ml | \$7.50/ea |
| JOR323D2 | Iodine, 250ml | \$10.50/ea |
| JOR323D3 | Decolorizer, 250ml | \$9.75/ea |
| JOR323D4 | Safranin Counter Stain, 250ml | \$9.60/ea |



Iodine Stain Kit **Jorvet**

Stain Concentration. Useful in identifying difficult to see parasites on fecal flotation or wet mounts. These include protozoan parasites like Giardia, Coccidia, and also helminth parasites. This stain is picked up readily by protozoan nuclear structures and also stains their glycogen masses. Some parasites, like Giardia are very difficult to view unless stained in this manner. 500ml with 4 oz. dropper bottle. 2.1% Iodine Stain. 500ml.

| | | |
|----------|-------------|------------|
| JOR325FM | 2.1%, 500ml | \$33.30/ea |
|----------|-------------|------------|



Live/Dead Semen Stain **Jorvet**

A necessary component of any male fertility exam is a microscopic evaluation of sperm morphology. The Jorvet Live/Dead Semen Stain is a eosin-nigrosin based stain that will stain sperm from every species. 2 x 7.5 ml bottles per package. Complete with detailed instructions and diagrams of abnormal spermatozoa. Keep refrigerated.

| | | |
|---------|-------|------------|
| JOR326S | 15 ml | \$18.60/ea |
|---------|-------|------------|



Lactophenol Cotton Blue **Jorvet**

This stain is useful for fungal exams. It is used in combination with the 10 percent KOH (JOR326). First the KOH clears various debris; then the lactophenol cotton blue will stain the fungal elements a deep blue. 120ml.

| | | |
|---------|-------|------------|
| JOR326B | 4 oz. | \$16.20/ea |
|---------|-------|------------|



New Methylene Blue Stain

This stain has many veterinary applications, from reticulocyte count to estrus vaginal smears. 250ml.

| | | |
|---------|---------------------------------|------------|
| JOR324A | 250ML Methylene blue stain 2 oz | \$8.70/ea |
| JOR324 | 250ml | \$21.00/ea |



Potassium Hydroxide 10% **Jorvet**

Useful in dissolving keratin and other debris when examining a slide for fungal components. 250ml.

| | | |
|--------|------------|-----------|
| JOR326 | 10%, 250ml | \$9.60/ea |
|--------|------------|-----------|



Sudan III Fecal Stain **Jorvet**

A quick diagnostic test is to use Sudan III stain as an aid in the assessment of maldigestion/malabsorption syndromes. The Sudan III will selectively stain lipid droplets orange on a fecal smear. 250ml.

| | | |
|--------|-------|------------|
| JOR325 | 250ml | \$12.60/ea |
|--------|-------|------------|



Coplin Staining Jar **Jorvet**

The Coplin staining jar is used for holding microscope slides during staining procedures. It is made of polyethylene. Internal grooves hold 6-8 standard slides.

| | | |
|--------|--------------------|------------|
| JOR814 | 59mm base, 114mm H | \$14.40/ea |
|--------|--------------------|------------|



Coplin Glass Jar **Jorvet**

Clear thick flint glass with internal ridges for separating slides from each other.

| | | |
|---------|--------------------------|------------|
| JOR814X | with black screw cap lid | \$12.00/ea |
|---------|--------------------------|------------|

0.2 Micron Filter **Jorvet**

Filter is used when transferring serum to 6ml syringes. Procedures will require multi filters. Syringe not included.

| | | |
|---------|---------|-----------|
| JOR1081 | Sterile | \$2.20/ea |
|---------|---------|-----------|



pH Checker, Counters & Portable Bunsen Burner

Jorvet Checker pH Meter

Small animal veterinarians spend a great deal of time discussing special dietary management and urinary acidifiers for controlling urinary tract disease. The maintaining of urine pH between 6.0 and 6.8 is necessary to minimize struvite crystal formation; usually paper reagent strips are used to determine urine pH through very subtle color changes. Using a pH meter is much more accurate than simple urine reagent strips.

Features:

- Economical, costs less than a bottle of reagent strips
- Fast, easy and highly accurate calibration: 0.2 pH at 68°
- High resolution: reads down to 0.01 pH units
- Small sample required, will fit into small container
- Small lightweight design: 2 1/2 oz with 6" electrode
- Battery operated with 3000 hour life

JOR753 Includes pH meter, screw-on electrode, buffer kit \$67.00/ea and storage solution.

Checker pH meter, complete kit,

Checker pH Meter Kit. Includes pH meter, screw-on electrode, buffer kit and storage solution.

JOR753K \$141.00/ea 

pH Replacement Electrode

JOR753D1 pH Replacement Electrode for Checker pH Meter. \$38.50/ea

Buffer Solution pH

JOR753D4 Buffer Kit. 5 packages of each solution for Checker pH Meter \$30.90/ea

JOR753D2 Buffer Solution, pH 4. 230ml for Checker pH Meter. \$24.60/ea

JOR753D3 Buffer Solution, pH 7. 230ml for Checker pH Meter \$24.60/ea

Electrode Storage Solution

JOR753D5 Electrode Storage Solution. 230ml for Checker pH Meter \$21.60/ea



Mortar with Pestle

Mortar with spout, outside wall and rim glazed, handle of pestle glazed. Individually boxed. Capacities 30 ml, rim piece 60mm

LPC-154-1 80 ml, volume 80mm rim \$2.00/ea

LPC-154 30 ml, volume 60mm rim \$1.64/ea

Ceramic Mortar and Pestle

The pharmacy aid for crushing tablets into fine powder. Fine quality ceramic mortar and pestle. Smooth surface with pouring lip. 4 oz.

JOR932 4 oz. \$41.50/ea

Portable Bunsen Burner

This portable completely self-contained compact burner features instant ignition for a fast and reliable startup every time. Simply rest your hand on the touch sensitive pad to instantly ignite the burner. Lift your hand from the pad when you're done to extinguish the flame and shut the unit off. The touch activated burner also features a handy dual use locking mechanism that will either lock the flame on, for those longer jobs, or function as a safety lock that prevents accidental ignition. Weighing just 11.2oz. 1 year warranty. Touch Activated Ignition Pad

- Self Contained & Butane Refillable
- Flame Adjustable Dial
- Butane Blue or Yellow Flame
- Safety Lock Prevents Ignition
- Lightweight and Portable - Moves easily between workspaces
- Includes 1 AA Battery
- Approx 65 mins burn time, will vary according to flame length



JOR1046 Sterilizes Instrument \$139.00/ea

Jorvet Cell Counter

Differential Cell Counter allows the percentage of each type of white blood cells to be counted (leukocytes). Every stroke makes a distinct sound, and when a total of 100 is reached a bell will ring.

JOR505A 5 key \$170.00/ea

JOR505B 8 key \$187.00/ea



Hand Held Tally Counter

Used for counting blood cells, bacteria colonies, drops of liquid or any repetitive event. Tallies up to 9,999. Features a quick reset button and a finger ring for a secure grip. Sturdy, chrome-finish metal construction.

JOR505 \$12.90/ea 



Jorvet Stat Tracker

This is a clever device for helping keep track of timed lab tests. The green light illuminates during the start process, at the halfway point the yellow light illuminates, and then the red light for the final alert. Select between six audible alerts. Time displayed on dual-line, 10-digit LCD. Operates on 110AC.

JOR812 Measures 4 1/2" x 4 1/2" x 9 1/4". \$67.00/ea



Veterinary Virology Sampling Kit

This kit is designed for collection and transportation of viral cultures. The kit consists of a specially designed flocked sample swab and a 1 ml universal transport medium specific for viral culture. Swab features: Velvet or brush textures of swab end is customized to collect maximum target samples. This swab features a unique molded breakpoint enabling safe, reliable break off and 6" length. Universal Transport Medium Features: Volume 1ml. Safe, shatterproof polypropylene skirted tube with distinctive internal conical shape enabling centrifugation of samples and allowing tubes to stand upright on the laboratory bench. Product can be conveniently stored at room temperature prior to use. Media formulation includes antibiotics to inhibit bacterial and fungal flora in patient samples. Three glass beads in each tube facilitate the release and dispersion of patient sample material and virus particles from the swab during vortexing.

JOR1031 \$3.40/pk 



Plastic Forceps

97-3901 5", 50 Per Pack \$5.73/pk

Centrifuges

Tabletop Centrifuge

A truly versatile 6 place bench top centrifuge. Perfect for the office lab or as a backup unit for a busy full service lab. Has an adjustable speed control for spinning urine and speed sensitive samples, a latchable lid and a safety switch.

- 6 place rotor (2-15 ml tubes)
- 30 minute timer
- Speed control (300 - 3,200 rpm)

C816 6-Place rotor \$264.00/ea



Microhematocrit Centrifuge

Jorvet

Microhematocrit Centrifuge. This durable centrifuge provides fast results. Features:

- Tube cover with built-in reader for centrifuge readings and reader card
- Auto off 15 minute timer (on/off switch with indicator light)
- Safety shut-off switch in impact resistant plastic window for safe viewing
- Brush less motor for smooth, quiet operation
- 24 tube (75mm capillary ea.) capacity
- Metal body construction
- Suction cup feet to prevent slipping
- 110V power

JOR503M 24-Place rotor \$870.00/ea



Jorvet Portafuge

Jorvet

The portable 8-place Porta-fuge is an economical fixed speed centrifuge designed for spinning on the go. This unit accommodates most test tubes from 3ml - 15ml. This unit is virtually maintenance-free and the lid port allows easy viewing and taching of specimens while in use. Simply insert the cigarette plug into your car's power outlet for quick blood separation at 3300rpm.

JOR501P Portable 12v \$295.00/ea



Universal Centrifuge

Jorvet

A truly affordable 24 place centrifuge with no extra charge for angle head rotor and 24 tube carriers. Features a top speed of 3,500 rpm, a built-in digital display tachometer, brake, speed, 30 minute timer, stainless steel guard bowl and latchable lid with safety interlock switch.

- 24 place
- Rotor (5-15 ml tubes)
- 30 minute timer
- Speed control (300 - 4,20000 rpm)

JOR502M 24-Place rotor \$1,150.00/ea



Jorvet Anti-Vibration Mat

A special 3M material that is designed to quiet noisy centrifuges or other vibrating instruments. The mat is chemical resistant, easy to clean, and will fit easily under most centrifuge models. The mat is blue.

JOR504X Blue, 14" x 14" \$40.00/ea

JOR504Y Blue, 15" x 18" \$53.00/ea

Jorvet



Jorvet Ultra Select Centrifuge

Jorvet

Are you spinning your samples at the correct RPM and G-force? Take the guesswork out of what speed your centrifuge should run on different fluids. This centrifuge uses the correct CLIA-recommended speeds for proper separation. Cell structures will not be damaged due to excessive G-forces and proper separation will always be achieved for urine, semen, fecals, blood, etc. The Ultra Select centrifuge features a 4-position speed dial to select the correct speed for each fluid.

- Specifications:
- Speeds: blood: 3,300 rpm, 1,314 Gs fecals: 1,500 rpm, 275 Gs urine/semen: 1,800 rpm, 400 Gs others: 800 rpm, 80 Gs
 - Same body and chassis as JOR501U
 - Auto-off 30-minute timer with bell
 - 110V AC (220V available)

JOR501W \$486.00/ea



Jorvet Ultra 8 Centrifuge

Jorvet

Ultra 8 Centrifuge is nearly indestructible. The one-piece aluminum alloy cast body is stable and strong, and the wide stance eliminates vibration and wobble. The new triangle design saves lab space, and can be easily tucked into a counter corner. The safety shut-off switch is integral in the locking latch, and the clear plastic view port allows for safe observation and speed calibrations. Available ready-to-use, and includes rubber tube cushions to accommodate tubes ranging from 3-15ml. Affordable. Features:

- Routine separation of fluids (i.e., blood and urine)
- 30-minute timer (on/off switch with indicator light)
- Spins up to eight 15ml tubes, 120ml maximum volume
- Impact resistant clear locking lid with safety shut-off switch
- One-piece body with suction cup feet for stability
- Metal rotor housing with smooth, quiet operating brushless motor
- Variable speed: 0-3,300 rpm
- 110V power
- 9" H X 13" W x 13" D. 151/2 lbs.
- One-year warranty on materials and workmanship

JOR501U Variable-Speed \$410.00/ea

Test Tube Holders

Only test to holders for this unit.

JOR501MD1 \$19.50/pr

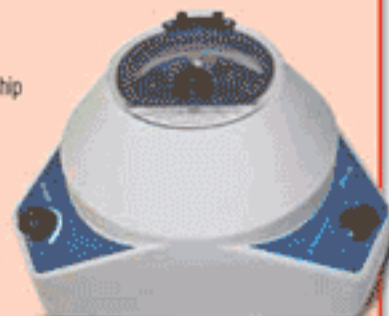

Jorvet 4 Place Centrifuge Rotor

JOR501SD1 50mm \$510.00/ea Jorvet

Centrifuges & Tubes



Centrifuge w/ IRAP and Regular Rotor

Horizontal centrifuges will recover significantly higher numbers of parasite ova than fixed-angle centrifuges or standing fecal flotation procedures. The JOR501sq centrifuge tubes hang vertically while at rest, allowing for the test tubes to be filled completely with a coverslip placed on top of the tube. The tubes then accelerate slowly and swing to a horizontal position while spinning. After completion, simply remove the coverslip and place directly onto a microscope slide. The J-501sq also performs routine urine and semen separations, high-speed blood separations in minutes, and can run microhematocrit samples. New air-piston lid hinges allow the lid to be held at any angle, which means it will fit on nearly all counter tops with low cabinets above.

Features:

- Touch-pad time and speed controls.
- 4-character digital display screen.
- 60 minute programmable timer.
- 800-5,000 rpm programmable speed.
- Rubber feet to prevent slipping.
- Impact-resistant lid with view port.
- One-year warranty on materials and workmanship. Dimensions: 133/4" W (350mm) x 151/2" L (394mm) x 141/4" H (362mm). Weight: 38.2 lbs (17.3kg).
- Includes Crit carriers (J-501c) for microhematocrit tubes (see below).



JOR501SQ with 4-place IRAP rotor and additional rotor for 15ml tubes, Green color, 100pk \$2,310.00/ea

Centrifuge C-5 w/ IRAP 4 Place Rotor

JOR501SQR with 4-place IRAP \$2,200.00/ea

Centrifuge w/ IRAP Rotor, 8-Place & Crit Carrier

JOR501SQIC \$2,380.00/ea

IRAP C-5 Rotor Only

JOR501IR IRAP Rotor only. \$795.00/ea

IRAP Ancillary Kit

JOR1081K IRAP Ancillary Kit. Enough ancillary for one IRAP procedure. Contains Jor464 (2), Jor463a (2), Jor1081 (2), Jor174btx (1). \$9.00/ea

Universal Cube Test Tube Rack

- 50ml tubes
- 15ml conical tubes
- 1.5ml micro tubes
- 7.5ml blood tubes

JOR878 2 racks/pk. \$17.70/pr



Jorvet Centrifuge Tube

Conical shaped tube with graduations

JOR546 Reusable Polypropylene Tube, 15ml. Autoclavable and unbreakable, 10/pk, Green Color, 100pk \$4.50

JOR546A Disposable Polystyrene Tube, 15ml, 100/box \$12.60/ea

Microcentrifuge Tubes

Excellent for serum, urine, or heartworm testing. The 1.5ml tube comes with attached push cap and conical bottom. 10mm (2/5") x 40mm (13/5").

JOR548 1.5ml, 100/pk \$8.70

JOR548A 1.5ml, 500/pk \$27.00

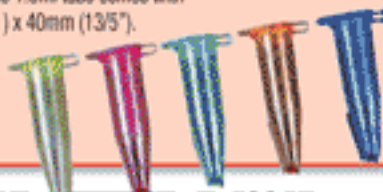

Swing Arm Centrifuge 8-3K

Horizontal separation offers many advantages over traditional fixed-angle separations, including tighter straight-line gel separations to reduce re-spins and re-mixes. Additionally, spun fecal floatations in the veterinary markets produce much higher ova recovery results when spun with coverslips on top of the test tube. The Swing-out Select spins 3ml-15ml test tubes, up to 17mm x 128mm, at speeds up to 3,000 rpm. Select either Blood, Urine, or Fecals on the speed control, set the 30-minute timer, and the Swing-out Select will spin at the correct speed. The all-metal rotor is built for strength and durability, and the wide mouth bowl allows for easy cleanup. The whisper-quiet, brushless, heavy-duty motor can handle high volume use and high-speed full loads for years to come. Specifications:

- Front-access calibration panel
- Brushless, maintenance-free 110V motor (220V brushed motor available)
- 8 test-tube (3ml-15ml) capacity
- 4-place 50ml rotor available
- Maximum tube size 17.5mm x 133mm
- Includes 3-prong power cord, 8 tube shields, 8 tube cushions (for shorter tubes).
- Dimensions: 12" H (305mm), 18" L (457mm), 14.5" W (368mm). Weight: 33 lbs (15kg)



Swing Arm Centrifuge Digital Control 50ml

4 place swing arm centrifuge with 50ml rotor, digital control.

JOR501ST \$2,199.00/ea

Tube Sleeves for Swing-Arm Centrifuge

JOR501SD2 \$23.00/pk

Swing Arm Centrifuge Digital Control

JOR501SQ 15ml \$1,800.00/ea

Jorvet Crit-Carrier

The Crit Carrier is specifically designed to run hematocrits on your Horizontal Centrifuge (minimum 5,000 rpm). Simply insert your hematocrit capillary tubes into the carrier, place the carriers in opposing tube sleeves for a balanced load, and spin at 5,000 rpm for 8 minutes for a true separation. The Crit Carrier converts the centrifuge into a Hematocrit Centrifuge. Save counter space and the need to purchase an additional hematocrit centrifuge. Spins up to 8 standard 75mm capillary tubes.



JOR501C \$215.00/pr

Jorvet Conical Centrifuge Tubes

Disposable polypropylene centrifuge tubes are sterilized for critical lab studies. Include polyethylene screw cap with flat top for easy writing or affixing labels. The tubes have bold, easy-to-read white graduations and a large writing area.

JOR546B w/Screw Cap 15ml, 100/bag \$22.50

JOR546D w/Screw Cap 50ml, 100/bag \$42.00

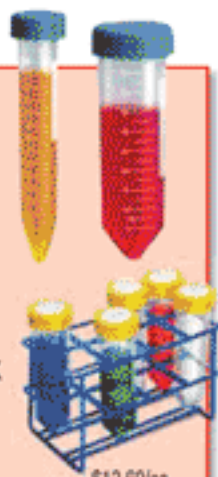

Jorvet Large 50ml Wire Tube Rack

Epoxy-coated wire rack that holds 50ml tubes. Tubes not included.

JOR879 Single 50ml Tube Rack, Interlocking. 3" x 2 3/4" high. \$12.60/ea

JOR879A 50ml Tube Rack. Holds eight 50ml Tubes. 5 3/4" x 3" x 3 3/4" high. \$33.00/ea

Laboratory Equipment & Supplies

Incubators & Spray Wash Bottles



Jorvet Incubator

A compact, inexpensive, and reliable incubator that is perfect for incubating cultures. Do a better job of diagnosis and treatment of bacteriological cases in your clinic with the use of this incubator.

- Clear plexiglass window
- 0.67 cubic foot, 12" x 8" x 12" chamber
- 15 lbs.
- UL listed
- 24-month limited warranty



| | | |
|----------|------------------------------------|-------------|
| JOR813 | 14.4" x 11.3" x 13.3" overall size | \$510.00/ea |
| JOR813D1 | Thermometer only for incubator | \$36.00/ea |

Jorvet Personal Eyewash Station

Jorvet

Mount on wall to provide immediate relief. This station holds two 32 oz. dosing bottles for thorough decontamination of face and eyes. Comfortable molded eye socket opening allows full flow of solution to completely irrigate affected eye. Imprinted emergency use instructions are on each bottle and station wall. Bottles are shipped empty to fill with water or saline depending on local regulations. Securely mount station with top and bottom holes (hardware included).



JOR889 17" W x 4" D x 14 1/2" H. \$144.00/ea

Uterine Cytology Brush

Jorvet

The use of a cytology brush is very common in female human patients. This cytology brush is a standard human cytology brush that is adhered to a culture swab insertion rod. It has the same double-guarded configuration as the JOR273.

JOR273C 10/box. \$105.00/pk



Jorvet Spray Wash Bottle

These wash bottles have a fine needle stream. Jorvet

| | | |
|---------|-------------------------------|------------|
| JOR818A | 16 oz., Polyethylene material | \$10.60/ea |
| JOR818 | 8 oz., Polyethylene material | \$10.20/ea |



Tieglund Modified Culture Swab

Jorvet

The original uterine culture swab. Swab is covered with outer flexible plastic tube. After the culture is taken, a scored ring 3 1/2" from the end allows the tube to snap off and is plugged with two included plastic caps. This allows for ease of transport and storage.

JOR274 33"L. 25/box. \$108.00/pk



Jorvet Safety Labeled Wash Bottles

Ensure leak proof dispensing of your common lab solutions. Polypropylene closure is 53mm W with a leak proof design. Easy-to-read and color-coded for content recognition and informative safety labeling:

- Printed bottle: Dept of Transportation (DOT)
- National fire protection (NFPA) codes and symbols
- Chemical abstract service number (CAS)
- Protective equipment symbols and target organ information All this information makes your workplace safer.

| | | |
|---------|--|------------|
| JOR817 | Complete set of 8 labeled wash bottles 500ml (16 oz) Bottle. | \$60.00/ea |
| JOR817A | Deionized water labeled wash bottle 500ml (16 oz) | \$8.10/ea |
| JOR817B | Distilled water labeled wash bottle 500ml (16 oz) | \$8.10/ea |

| | | |
|---------|--|------------|
| JOR817C | Saline solution labeled wash bottle 500ml (16 oz) | \$8.10/ea |
| JOR817D | Sodium hypochlorite (bleach) wash bottle 500ml (16 oz) | \$8.10/ea |
| JOR817E | Soap labeled wash bottle 500ml (16 oz) | \$8.10/ea |
| JOR817F | Ethanol labeled wash bottle 500ml | \$8.10/ea |
| JOR817G | LYOB wash bottle 500ml (16 oz) | \$8.10/ea |
| JOR817H | Isopropanol labeled wash bottle 500ml (16 oz) | \$8.10/ea |
| JOR817K | Distilled water labeled wash bottle 1,000ml (32 oz) | \$10.50/ea |
| JOR817M | Isopropanol labeled wash bottle 1,000ml (32 oz) | \$10.50/ea |
| JOR817Q | Ethanol labeled wash bottle 1,000ml (32 oz) | \$10.50/ea |
| JOR817R | LYOB wash bottle 1,000ml (32 oz) | \$10.50/ea |
| JOR817S | Complete set of 4 labeled wash bottles 1,000ml (32 oz) | \$42.00/ea |



13822 WEST BOULTON BLVD. METTAWA, IL 60045

WWW.SHOPMEDVET.COM

Phone 800-544-7521

324

Fax 800-204-2177

Swabs

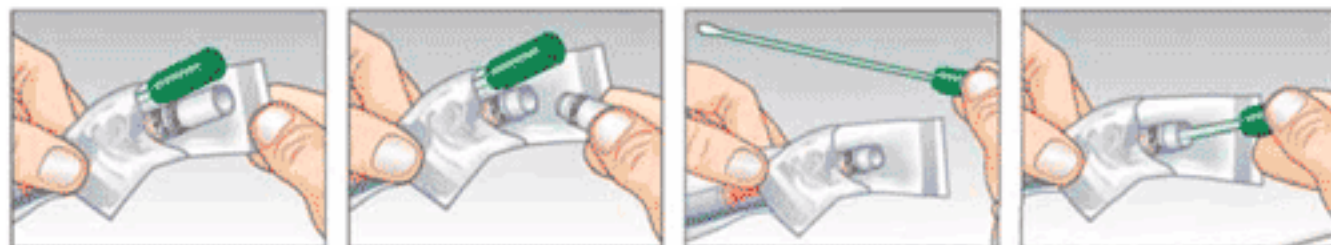

Agar Gel Transport Swab

Veterinarians often encounter challenging infectious cases that require a bacterial culture and antibiotic sensitivity. A quality transport swab will preserve the specimen from the patient to the laboratory, whether the lab is in the next room or in the next state. Individually wrapped, 50/carton. Features:

- Extra-long 5 1/4" swab shafts enable easier access to difficult sites without contamination
- Soft rayon swab tips are inert and non-toxic to micro-organisms and patients
- Tamper evident tube seal
- Large pre-attached label
- Non-breakable polypropylene tube with hour glass design squeezes out undesirable air harmful to fastidious bacteria, and prevents disintegration of gel column during transportation
- 5ml deep agar gel column insures maximum protection, improves sample viability, and optimizes moisture control



| | | |
|---------|--|------------|
| JOR867A | Amies Agar Gel with Charcoal Transport Swab, 50/carton | \$43.50/ea |
| JOR867T | Stuart's Liquid Media w/foam sponge, 50/carton | \$43.50 |
| JOR867 | Most popular, 50/carton | \$43.50/pk |

Jorvet Double Guarded Culture Swab

This swab is protected by two outer plastic sheaths and a cap. The outer sheath and cap are penetrated after the swab passes the cervix into the uterus. The swab is scored so its length can be reduced and then covered with the two included caps for storage or transport.

JOR273 33"L., 25/box. \$98.50/pk



Jorvet



Jorvet Culture Swabs

Jorvet

Getting a culture or cytology sample from the equine guttural pouch is a real challenge. The conventional swabs do not have the proper angulation for entry into the guttural pouch. This 22" culture swab is bent to about a 30° angle. After the sample is obtained, it can be removed with the outer sheath still in the guttural pouch. Then medication can be infused if found necessary. The swab is covered by a methylcellulose plug prior to entry and to avoid contamination. 5/pk. (not pictured)

| | | |
|---------|-------------------------------------|------------|
| JOR726 | 2.0mm x 100cm, 5/pk. (not pictured) | \$9.30/ea |
| JOR726A | 2.0mm x 140cm | \$16.50/ea |
| JOR726B | 2.6mm x 140cm | \$9.30/ea |
| JOR726D | 2.6mm x 250cm | \$12.00/ea |
| JOR726C | 2.6mm x 170cm | \$10.80/ea |

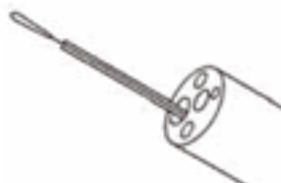

Jorvet Guttural Pouch Culture Swab

Getting a culture or cytology sample from the equine guttural pouch is a real challenge. The conventional swabs do not have the proper angulation for entry into the guttural pouch. This 22" culture swab is bent to about a 30° angle. After the sample is obtained, it can be removed with the outer sheath still in the guttural pouch. Then medication can be infused if found necessary. The swab is covered by a methylcellulose plug prior to entry and to avoid contamination. 5/pk. (not pictured)

JOR726G 5pk \$54.00/pk **Jorvet**



Cytology Swabs

Jorvet

| | | |
|---------|---------------|------------|
| JOR725B | 2.6mm x 140cm | \$11.25/ea |
| JOR725C | 2.6mm x 170cm | \$12.15/ea |
| JOR725D | 2.6mm x 250cm | \$13.80/ea |
| JOR725 | 2.0mm x 100cm | \$13.50/ea |

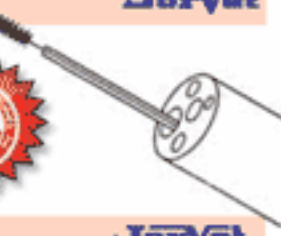

Jorvet Guarded Culture Swab

The most popular style of culture swab. A hinged guard or cap covers the tipped swab. This bullet-shaped tip allows easier insertion and protects the swab from contaminants. 28"L flexible rod compares in style to Kalayjian™ brand culture swabs.

JOR272 25/box. \$96.00/pk



Jorvet

Inoculation Loops

Jorvet

Double-ended inoculation loop. One end has a 10ul size loop the other end a smaller 1ul loop, disposable individually wrapped and sterile. 50/pk Polystyrene

JOR549A Sterile, 50 \$13.50/ea



Inoculating Loop with Handle

Jorvet

Inoculating loops are a necessary part of doing any sort of bacterial culturing. These Nichrome wire loops are attached to an anodized aluminum handle. The wire loops are durable plus rapidly cool following heat or flame sterilization. The loop is a 3mm diameter or 26g wire. Each.

JOR549C \$10.80/ea/ea



Laboratory Equipment & Supplies

Fecal Testing, Capillary Tubes & Insemination Kit



Fecatector Diagnostic Kit

A unique, sanitary leak-proof collection device, to be used by the client for obtaining fecal samples from pets. The same container then doubles as the laboratory flotation device. This eliminates the need for technicians to transfer or contact the stool sample. Comes complete with laboratory instructions card and easy-to-follow client instruction sheets. Comes in a compact display box for wall-mounted or counter use.

606-2799 50 kits per box \$17.99/bx



Hydrometer for Fecal Flotation Solutions Jorvet

This hydrometer is perfect for testing fecal flotation solutions in the narrow specific gravity range of 1.18 to 1.25. The best results for detection of parasitic ova are using solutions in the S.G. range. This hydrometer is the best and easiest way to confirm you are using the right solution. 6" long glass suggest clear round graduated cylinder (JOR281d2) for holding and floating hydrometer.

JOR501H Gravity Range of 1.18 to 1.25 \$37.30/ea



Sheather's Sugar Flotation Solution

Find more eggs! Recent studies have proven that centrifugation of fecal samples is for more effective than traditional standing passive flotation. Furthermore, a flotation media must have a higher specific gravity than 1.20 to float many of the common parasite ova. Sheather's sugar solution has a specific gravity of 1.27 which is high enough to float any ova. Basic Physics: If an ova has a higher specific gravity than the flotation solution, it will not float nor will it be detected. Jorvet

JOR1028 500ml bottle \$4.20/ea

JOR1028G Gallon Size Bottle \$22.50/ea



Dermatophyte Test Medium

RXDTM-CULTURE 10 cultures/box **\$15.40/bx**

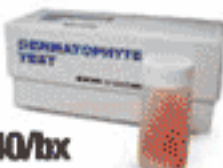

Zinc Sulfate Fecal Flotation Medium

RXOVA-GAL 1 gallon **\$10.99/gal**



Optical Lens Paper

Non-scratch optical lens paper suitable for cleaning cameras, microscopes, and other optical instruments.

MA02 4x6", 100 sheets/pack, 12 pack/box \$13.44/bx

"No-Residue" Microscope Lens Cleaning Solution

1 oz. dispensing bottle. Removes dried residue from objectives.

JOR869S Use with JOR869 lens tissues. \$12.00/ea



Capillary Sealant Tray Jorvet

Leak-tight sealant formed quickly from unique compound designed to withstand centrifugation. Non-toxic, non-drying, non-hardening.

JOR545 Tip resistant tray for upright storage of 24 tubes. \$6.30/ea



Microhematocrit Capillary Tubes

These capillary tubes are designed for both safe blood collection as well as an accurate microhematocrit determination. Precision molded, they provide excellent sample retention during centrifugation. Tubes fill rapidly without affecting specimen integrity. Tube 1.15mm i.d. x 1.55mm o.d. 75mm length. Packaged in a protective snap cap vial. 100 tubes/vial/10 vials/cs

JOR542 100-pack, 10 pk/case \$51.00/cs

JOR543 Red Tip, Heparinized Tube, 100/vial \$33.00/cs

JOR544 Blue tip plain microhematocrit tubes \$30.00/cs

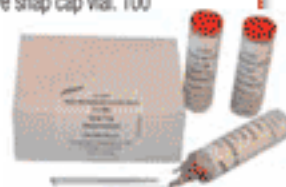

Standard 75mm Microhematocrit Tube

Wrapped with three layers of Mylar. Hemato-clad hematocrit tubes combine the precision of glass with the safety provided by a mylar over wrap. Accidental breakage is significantly reduced particularly when pressing into sealing clay. In the event of breakage, the Mylar wrapping will help contain the blood sample and provides an added layer of protection against cuts from broken glass. Handy dispensing vial with chrome lid.

JOR543M Blue Tip. Plain tube \$90.00/cs

JOR544M \$91.00/pk



Plastic Forceps

97-3901 5", 50 Per Pack \$5.73/pk

Jorvet Small Animal Artificial Insemination Kit

A complete kit for the veterinarian for the collection of semen and insemination of the female.

Includes:

- Latex collection cone
- Four vaginal pipettes
- 12cc syringe
- Small plastic cap for end of syringe
- Cone holder
- Direction sheet
- JORJelly lubricating gel, 8 oz. flask

JOR102 Complete Kit \$28.80/ea



Formalin-Filled Container Jorvet

Biopsy and tissue samples need to be handled properly for the best results. These clear polystyrene containers are pre filled with 10 percent phosphate buffered formalin. The screw caps are lined polyethylene that are leak tight and grooved for secure handling. In accordance with OSHA requirements, the containers are affixed with warning labels containing sufficient space for writing patient's name, specimen description, and the veterinarian's name.

JOR552 15ml, 10 pk \$7.80/pk

JOR552A 30ml \$9.30/pk

JOR552B 60ml \$15.30/pk

JOR552C 120ml \$15.30/pk



13822 WEST BOULTON BLVD. METTAWA, IL 60045

WWW.SHOPMEDVET.COM

Phone 800-544-7521

326

Fax 800-204-2177

X-Ray Products

X-Ray Illuminators & Cassette Accessories



Jorvet Slimlite X-ray Illuminator

High quality radiographs should be matched with a high quality viewing box for the maximum diagnostic image. The Jorvet Slim Lite viewing box uses new "Edgelite" technology with proprietary light diffusion material giving an almost sunlight illumination with 5,000° Kelvin color temperature. In addition, this "Edgelite" format allows a much thinner or streamlined attractive profile than other viewing boxes.

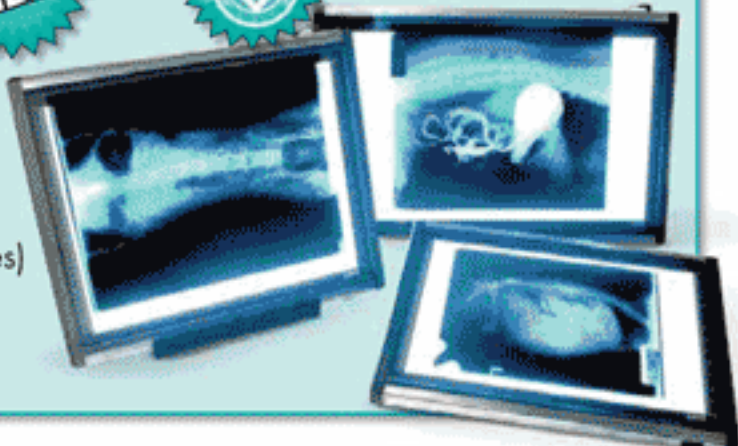

Slimlite X-ray illuminator (Accessories)

| | | | | | |
|---------|-----------|-------------|---------|--|-------------|
| JOR806A | 12" x 18" | \$346.00/ea | JOR806Q | 4 Amp Battery Pack for X-ray Illuminator | \$123.00/ea |
| JOR806B | 14" x 18" | \$426.00/ea | JOR806S | Desk Stand for Portable Slimlite | \$52.00/ea |
| JOR806C | 14" x 24" | \$530.00/ea | | | |

X-Ray Illuminator

Superior quality plexiglass front. Desktop or wall mount. 110 volts.

| | | |
|-----------|-----------------------|-------------|
| ILLDOUBLE | Double Bank 28" X 17" | \$239.00/ea |
| ILLSINGLE | Single Bank 14" X 17" | \$125.00/ea |

X-Ray Illuminator Bulb

Replacement bulb for x-ray illuminator.

| | | |
|----------|----------|------------|
| ILL-BULB | Bulb, ea | \$18.00/ea |
|----------|----------|------------|

Single Bank X-ray Illuminator

Single bank constructed of all steel. High luster white powder coat. One piece plexiglass panel with 14" x 17" viewing area. Three-bulb configuration. Roller gravity grips.

| | | | |
|---------|----------------|-------------|---------------|
| JOR806Y | 110V AC Power. | \$139.00/ea | JorVet |
|---------|----------------|-------------|---------------|



Double Bank X-ray Illuminator

Two 14" x 17" viewing areas. Individual on/off switch, 5 bulb configuration.

| | | | |
|---------|-------------------------|-------------|---------------|
| JOR806Z | 32"(w)x 23"(h)x 48" (d) | \$204.00/ea | JorVet |
|---------|-------------------------|-------------|---------------|

Equine X-ray Cassette Holder **JorVet**

A lightweight piece of equipment that allows the cassette to be held at any angle but keeps the person holding it out of the harmful X-ray beam. Will hold both 8" x 10" and 10" x 12" cassettes. 36" shaft. Quick release clamp. Breakdown model for easy storage.

| | | |
|--------|---------------------|-------------|
| JOR296 | 12"W x 42"L. 2 lbs. | \$150.00/ea |
|--------|---------------------|-------------|



Sterile X-ray Cassette Cover

| | | |
|--------|--------------------------|-----------|
| JOR682 | for 8" x 10" & 10" x 12" | \$4.30/pr |
|--------|--------------------------|-----------|



Jorvet Slimlite X-ray Illuminator (Accessories)

High quality radiographs should be matched with a high quality viewing box for the maximum diagnostic image. The Jorvet Slim Lite viewing box uses new "Edgelite" technology with proprietary light diffusion material giving an almost sunlight illumination with 5,000° Kelvin color temperature. In addition, this "Edgelite" format allows a much thinner or streamlined attractive profile than other viewing boxes.

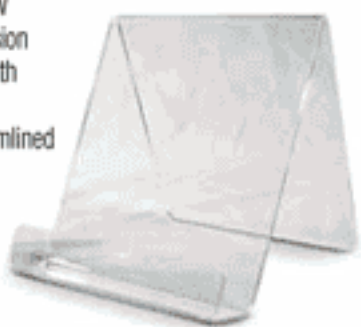

| | | |
|---------|--|-------------|
| JOR806Q | 4 amp Battery Pack for X-ray illuminator | \$123.00/ea |
| JOR806S | Desk Stand for Portable Slimlite | \$52.00/ea |

Magna Arm Magnifier for X-ray Illuminators

Allows the user to magnify 4x the details of X-Ray film. It is attached to a fully articulated locking arm that holds the 2" dia. half-sphere magnifier in place for hands-free magnification.

| | | |
|----------|-----------------------|-------------|
| JOR806M | Small Illuminators | \$195.00/ea |
| JOR806MA | Large Illuminators | \$205.00/ea |
| JOR806MP | Portable Illuminators | \$166.00/ea |



Crystal View with Wood Base

| | | |
|---------|--------|------------|
| JOR806X | 2 1/2" | \$40.50/ea |
|---------|--------|------------|



Nylon Padded Carry Case for X-ray Illuminator

| | |
|---------|------------|
| JOR806P | \$74.00/ea |
|---------|------------|



X-Ray Products

Stands, Positioners, Laser Pointer & Cassette Accessories



Ultra Stand X-ray Machine Support

This stand holds a portable x-ray machine for steady, but adjustable x-rays. Portable x-ray units can become heavy and difficult to hold steady if a variety or wide range of x-rays need to be taken.

- Weighs just 16 lbs including 4 locking caster wheels
- Setup takes only minutes
- Trigger release allows movement up and down in 1" increments
- Folds up for ease of storage

JOR493M Stand Only \$760.00/ea



Jorvet Quick Shot X-ray Cassette

This handy device holds the cassette at arm's length directly attached to the portable x-ray unit. The "Quick Shot" allows a single person to take films and eliminates the need for assistance.

- Lightweight aluminum weighs only 2 1/2 lbs.
- Adjustable handle allows usage with all commercial portable x-ray units.
- Holds wide range of cassette and grid sizes
- No guess work in achieving proper focal lengths
- "Bubble" level mounted on top of the handle and side of the cassette holder
- Adjustment knobs allow positioning of cassettes at all angles
- Folds flat for easy storage
- Foam padded handle has holder for x-ray machine trigger
- Removes many positioning variables

JOR493X X-ray Machine not included \$420.00/ea



Tomahawk X-ray Cassette Holder

This hand held positioner safely holds 8x10", 10x12", and 14x17" cassettes for a wide range of views and maintains safety by avoiding exposure to the x-ray beam. Features:

- Lightweight aluminum weighs 2 1/2 lbs.
- Spring loaded clamp holds full range of cassettes sizes with easy changing
- Rotating grip handle telescopes in length
- 2 handles provided:
- Long handle 32" - 54"
- Short handle 0" - 20"
- Has non slip black plastic grip
- Center ground support leg also telescopes from 0-20" in height
- "Bubble" level on top helps give accurate position
- Folds up for easy storage in mobile vet units.

JOR492M \$355.00/ea



Jorvet Redden Navicular Stand

Getting consistent and repeatable navicular views is one of the toughest equine X-ray challenges. This design aligns all 3 factors—the machine, the hoof, and the cassette.

- Spacer bar holds X-ray machine at correct focal length
- Outstanding evaluation of navicular bone is possible through a 45° oblique view
- Stand is made of cast aluminium
- Stand will pay for itself the first two times you do not have to retake navicular views



JOR495RB Navicular Stand Only \$162.00/ea
 JOR495R With X-ray machine holder. Designed for the min-X-ray unit. \$260.00/ea

Jorvet Equiprax X-ray Positioner

Clinical field situations often result in varying angles, distance, and exposure. Lesions (particularly on the navicular bone and the 3rd phalanx) can be obscured or eliminated by variations in the radiographic position. The Equiprax Radiograph Positioner was designed by an equine practitioner to give consistent quality diagnostic radiographs. Allows for five different views.

JOR275 \$198.00/ea



Jorvet X-ray Sandbags

New regulations regarding exposure to radiation make it difficult to hold animals in position while taking radiographs. These bags are made of heavy nylon navy blue canvas filled with sand (not included). Heavy-duty plastic liners provide leak proof use.

- One 23" x 7" pillow weight
- One 11" x 11" pillow weight
- Body sling with snap hooks use either two 8" x 8" hanging weights OR two 6" x 17" hanging weights
- One body sling

JOR685 7 pc Set Without Sand \$33.00/ea

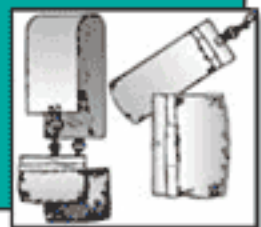

Dual Laser Pointer for X-ray Units Holder

Standard collimator white light is difficult to see in outdoor sunlight or even indoor light. This makes achieving the proper focal distance difficult. This small dual pointer mounts on a portable x-ray unit. The twin beams cross at the preferred 26" film focal distance and can be seen in any lighting situation. Uses standard watch batteries.

JOR493W Uses standard watch batteries. \$280.00/ea

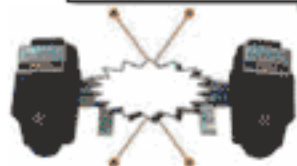

Jorvet Radiograph Cassette Tunnel

Navicular and skyline shots are easy with this cassette tunnel plus it protects your delicate cassettes.

- Lightweight shatter resistant polycarbonate top with solid oak frame
- Bottom is lined with lead to prevent back scatter
- Holds 8" x 10" standard cassettes
- Has a toe grab to hold hoof in place
- Tilting support base allow any angle change or upright shots
- Non-slip surface
- Carrying handle

JOR494MA Uses standard watch batteries. \$240.00/ea

JOR494M Uses standard watch batteries. \$232.00/ea



13822 WEST BOULTON BLVD. METTAWA, IL 60045

WWW.SHOPMEDVET.COM

Phone 800-544-7521

328

Fax 800-204-2177



Aprons, Gloves & Miscellaneous X-Ray Supplies

X-Ray Aprons

Our quick-release belt buckle system is easy to use and helps transfer the weight of the apron from the shoulders to the waist. The nylon exterior is easy to clean, yet flexible enough for hassle-free movement. 0.5mm pb equivalent

60895 .5mm Protection \$180.00/ea



X-Ray Protective Apron

Velcro tie apron. Velcro flaps at the waist. Maroon with black paw print design. **Gloves Sold Separately** **Jorvet**

JOR676WB 36" length \$138.00/ea
 JOR676WA 32" length \$138.00/ea



X-Ray Thyroid Cover

Our Thyroid Collar is exceptionally pliable and comfortable to wear. It provides 0.5 mm lead protective equivalency.

63421 .5mm Protection \$39.95/ea



X-Ray Thyroid Collar

Protection of the sensitive thyroid is recommended when a lot of X-Ray exposure is possible. Navy blue nylon with velcro attachments. 0.5mm lead thickness. **Jorvet**

JOR679 Navy Blue \$31.50/ea



X-Ray Gloves

Particularly ideal for the emergency room area, these molded lead gloves take advantage of new technology to provide increased dexterity. Special surface sealant eliminates the need for an outside cover.

69358 Small \$163.00/pr
 69359 Medium \$163.00/pr
 69360 Large \$163.00/pr



X-Ray Protective Gloves

Seamless lead vinyl gloves are a 15" one piece dip molded glove with supple vinyl cover and foam liner. Burgundy color. Standard protection 0.5mm Pb equivalency

JOR677X \$175.00/pr



X-Ray Mittens

This 0.5mm vinyl covered mitten is a standard size 9. Perfect for general department or veterinary use.

69550 .5mm Protection \$115.00/pr

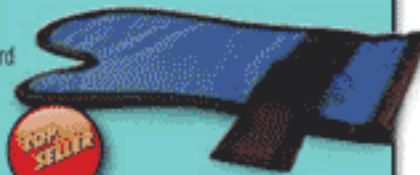

Slit Mitt X-Ray Gloves

- Finger slits for complete finger movement as well as total hand protection.
- Provides 0.5mm Pb protection.
- Manufactured with soft lead for superior flexibility.

SM-100T pair \$135.00/pr



X-Ray Label Tape

X-ray labels protect your patients and your practice with reliable, permanent x-ray identification

75-02C 3/4" X 2" 100/bx \$18.00/bx
 75-03C 3/4" X 3" 100/bx \$25.75/bx
 75-25R 3/4" X 25' 1 Roll \$24.50/rl



X-Ray Density Filter

Available in white, green and yellow. Please indicate color at time of order. Prices on x-ray density filters are subject to change without notice. Please contact one of our friendly customer service representatives for current pricing.

DF-P Plain \$16.07/ea
 DF-R/L R/Lt \$26.78/ea
 DF-D/W/D D/Wd \$26.78/ea

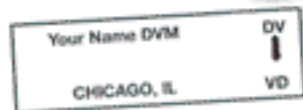

X-Ray Developing Hanger

Stainless steel metal hanger holds the x-ray film while in the developing or processing tanks. Clip on to the four corners of the film.

JOR678 8" X 10" \$27.00/ea
 JOR678A 10" X 12" \$27.00/ea
 JOR678B 14" X 17" \$27.00/ea

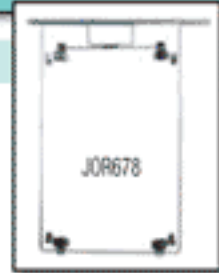

X-ray Measuring Caliper

Getting the correct thickness of your patient is critical to proper KVP setting and quality diagnostic radiographs. Measurements in centimeters only. Stainless steel.

JOR684 Stainless steel \$25.50/ea



Dental X-ray Film Mounts

Veterinarians are increasingly using specific dental x-ray machines. A dental x-ray unit uses very small dental film and requires multiple film pieces. This small film is difficult to store and catalog correctly. The dental film mounts help solve this problem.

JOR977 Handy dispenser box containing 1,000 mounts for 500 pairs in vertical side-by-side format. You tear off as many as needed. \$44.00/ea
 JOR977A Side-by-side, 100pk \$14.50/pk
 JOR977B Four mounts in a horizontal row, 100pk of fours. \$20.50/pk



Jorvet X-ray Cassette

JOR680 w/Medium Speed Screen, 8" x 10" \$90.00/ea



Miscellaneous & Reference

Canine & Feline Models



Canine Lumbar Model

Vertebral column of average size dog features 5 lumbar vertebrae and discs, caudal (tail) vertebrae and sacrum

- Model Size: 8" x 2" x 2"
- Card Size: 6-1/2" x 5-1/4"
- Base Size: 6-1/2" x 5" x 1"

G1080 8" x 2" x 2" \$84.20/ea

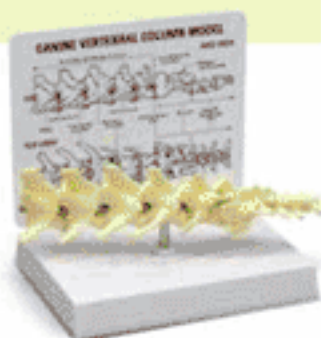

Canine Knee Model

Average size dog knee with femur, fibula, patella and tibia bones, lateral and medial meniscus, anterior and posterior cruciate ligaments, plus 6 more ligaments and tendons.

- Model Size: 2" x 3-1/2" x 7"
- Card Size: 5-1/4" x 6-1/2"
- Base Size: 6-1/2" x 5" x 1"

G1050 2" x 3-1/2" x 7" \$76.60/ea

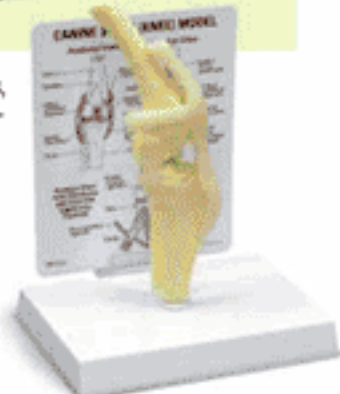

Canine Ear Model

This 2-sided, average size, canine ear depicts: a normal side with cochlea, auditory tube, tympanic bulla, middle ear cavity, tympanic membrane, horizontal canal, vertical canal, auricular cartilage, pinna and temporalis muscle. The diseased side illustrates: inflamed inner ear structures, inflammatory exudate in tympanic bulla, ear canal with partial occlusion from cellular hyperplasia, inflammatory exudate and an inflamed outer ear.

- Model Size: 4.75" x 2.75" x 2"
- Card Size: 5-1/4" x 6-1/2"

G1200 4.75" x 2.75" x 2" \$84.00/ea

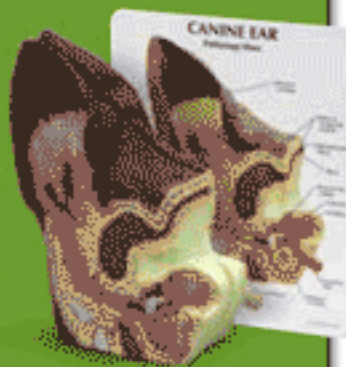

Ear Model

Otic exams are a common daily practice for veterinarians. However, the client never sees what the veterinarian sees. This cut-away model outlines the normal anatomy of the ear plus associated nearby structures. It also illustrates common ear disease like otitis externa, polyps and even has a foxtail. The pinna shows a hematoma and a fly strike. Accompanied with a laminated color explanatory chart. Hand painted in beautiful colors.

JOR772 3 1/2"W x 6"H x 2"D. \$76.00/ea



Heartworm Disease Model

Cut-away view of an average size dog heart with improved decoration of arteries, fat & 3 sections of heartworm parasites.

- Model Size: 3" x 3-1/2" x 4-1/4"
- Card Size: 6-1/2" x 5-1/4"
- Base Size: 6-1/2" x 5" x 1"

G1150 3" x 3-1/2" x 4-1/4" \$76.00/ea

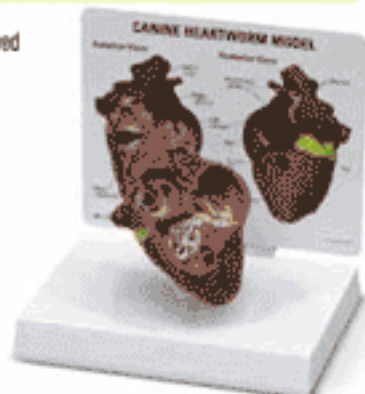

Feline Skeletal Model

Model of the skeleton of a cat features a removable tail and skull with jaw on springs. Mounted on Base.

CHC1 16"L x 9" H \$89.95/ea



Canine Hip Model

Average size dog pelvis that features both normal and osteoarthritic bone, body of ilium, greater trochanter, head in acetabulum, herniated disk, neck of femur, nerve, sacrum, and third trochanter.

- Model Size: 7" x 5-1/2" x 11"
- Card Size: 8-1/4" x 6-1/4"
- Base Size: 6-1/2" x 5" x 1"

G1060 7" x 5-1/2" x 11" \$110.00/ea

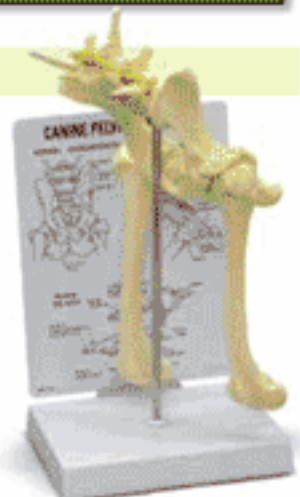

Canine Skeleton Model

Skeleton of an average-sized dog with removable tail and skull with jaw on springs. Mounted on base.

CHD1 21" x 12" \$89.95/ea



Canine & Feline Models



Canine Elbow Model

Healthy left elbow of average size dog includes: humerus, radius and ulna bones; plus 6 ligaments.

- Model Size: 9-1/2" x 1-3/4" x 7-1/2"
- Card Size: 6-1/4" x 8-1/4"
- Base Size: 6-1/2" x 5" x 1"

G1070 9-1/2" x 1-3/4" x 7-1/2" \$82.20/ea

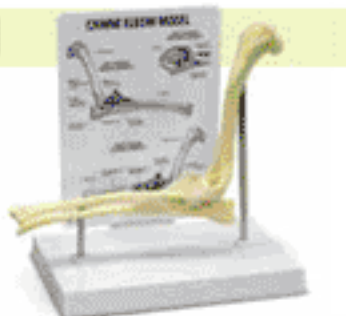

Canine Shoulder Model

Average size dog shoulder with scapula, humerus, biceps brachii tendon, coracobrachialis tendon, lateral glenohumeral ligament, medial glenohumeral ligament and transverse humeral ligament.

- Model Size: 11-1/8" x 3" x 2"
- Card Size: 6-1/4" x 8-1/4"
- Base Size: 6-1/2" x 5" x 1"

G1075 11-1/8" x 3" x 2" \$90.20/ea



Canine Hip/Lower Back Model

- One hip joint features normal anatomy, the other shows pathology, (i.e., hip dysplasia)
- Normal and abnormal inter-vertebral discs
- Spinal cord and nerve roots are in yellow
- Lumbosacral joint

JOR775 Wood base 7" x 9" \$118.00/ea



Canine Skeleton Model

- Canine Skeleton, skeletons are a great client education tool plus the veterinarian can refer back to them.
- Made from urethane plastic.
- Less fragile or brittle than unprotected natural bone
- Mounted on a wood base

JOR774 6"W x 11"H x 31"L. \$110.00/ea



Heart Model



Heart Model with adult heartworms. This two-piece model offers a dramatic representation of what a heartworm infection can look like. Accompanied with a laminated color explanatory chart. Hand painted in beautiful colors.

JOR773 \$76.00/ea



Canine Jaw Clear Model

Healthy canine hinged jaw showing the roots of all teeth (incisors, canine, premolars, molars). Can be separated for better observation.

Model Size: 4-3/4" x 2-3/4" x 2"
Card Size: 6-1/2" x 5-1/4"

G1196 4-3/4" x 2-3/4" x 2" \$100.00/ea

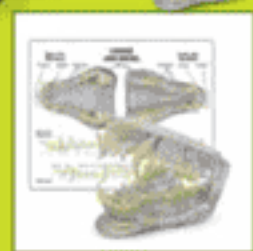

Canine Jaw Model

Average size canine jaw depicts healthy teeth on the right side and diseased/damaged teeth on the left. The nine pathologies featured are: fractured canine, periodontal disease, tartar accumulation, plaque, gingivitis, worn incisors, retained deciduous teeth, gingival recession and missing premolar. The jaw may be opened, closed and separated for closer study. **Jorvet**

Model Size: 4.75" x 2.75" x 2"
Card Size: 6-1/2" x 5-1/4"

ADM-1 Canine 4.75" x 2.75" x 2" \$128.00/ea
ADM-2 Feline 2.75" x 2" x 1.125" \$118.00/ea

Feline Jaw Clear Model

G9191 \$100.00/ea *Not Pictured*



Dental Model (Clear)

Beautiful clear acrylic models are great demonstration tools for clients. The entire dental arcade is shown in anatomically correct presentation. The shape of roots can be seen. Teeth are natural color.

JOR770D Canine \$310.00/ea
JOR770F Feline \$260.00/ea
JOR770DF Set of clear dental models \$486.00/ea
(JOR770D & JOR770F)
Canine and Feline



Pathology Dental Model **Jorvet**

These realistic models are all in natural colors of gum tissue and teeth. One side shows examples of over 20 common dental problems, the other side shows normal anatomy. Accompanied with a laminated color chart identifying all pathologies.

JOR771S Set of 2 Canine & Feline Models \$180.00/ea
JOR771 Canine Model \$101.00/ea
JOR771C Feline Model \$128.00/ea



Canine Stifle Model

Canine Stifle. Shows all ligaments and related structures like the meniscus. Only normal structures are shown.

JOR776 Wooden base 4 1/2" x 6" \$39.00/ea





Veterinary Anatomical Charts

Produced by Anatomical Chart Company, these scientific and medical illustrations are designed in consultation with veterinarians and zoologists to develop charts illustrating the anatomy, systems, structures, diseases and conditions of selected domestic animals. The first installment in this new line of veterinary charts are the Skeletal Anatomy of the Horse, the Cat and the Dog. A detailed illustration of the animal and its skeletal system is the focus of each chart. Details of the skeletal system and specific diseases are also illustrated. Each chart measures 26" by 20" and is printed on high quality heavy paper. All charts are available in paper, flexible lamination and rigid lamination.

Canine Muscular Anatomy Chart (A)

8704-PL1.5 26" x 20", Flexible \$19.95/ea
 8704-PL 26" x 20", Rigid \$33.95/ea

Canine Skeletal Anatomy Chart (B)

8703-PL1.5 26" x 20", Flexible \$19.95/ea

Canine Internal Anatomy Chart (C)

8705-PL1.5 26" x 20", Flexible \$19.95/ea

Feline Skeletal Anatomy Chart (D)

8702-PL1.5 26" x 20", Flexible \$19.95/ea



Medical Charts



Equine Charts

Produced by Anatomical Chart Company, these scientific and medical illustrations are designed in consultation with veterinarians and zoologists to develop charts illustrating the anatomy, systems, structures, diseases and conditions of selected domestic animals.

A detailed illustration of the animal and its skeletal system and specific diseases are also illustrated. Each chart measures 26" by 20" and is printed on high quality heavy paper and has a flexible lamination applied.

| | | |
|-------|---------------------|------------|
| EQ-01 | Conformation | \$22.95/ea |
| EQ-02 | Dental | \$22.95/ea |
| EQ-03 | Digestive | \$22.95/ea |
| EQ-04 | Foaling | \$19.95/ea |
| EQ-05 | Foot & Hoof | \$22.95/ea |
| EQ-06 | Forelimb Joint | \$22.95/ea |
| EQ-08 | Hindlimb Joint | \$22.95/ea |
| EQ-11 | Neurological | \$19.95/ea |
| EQ-13 | Anatomy/Vital Signs | \$22.95/ea |

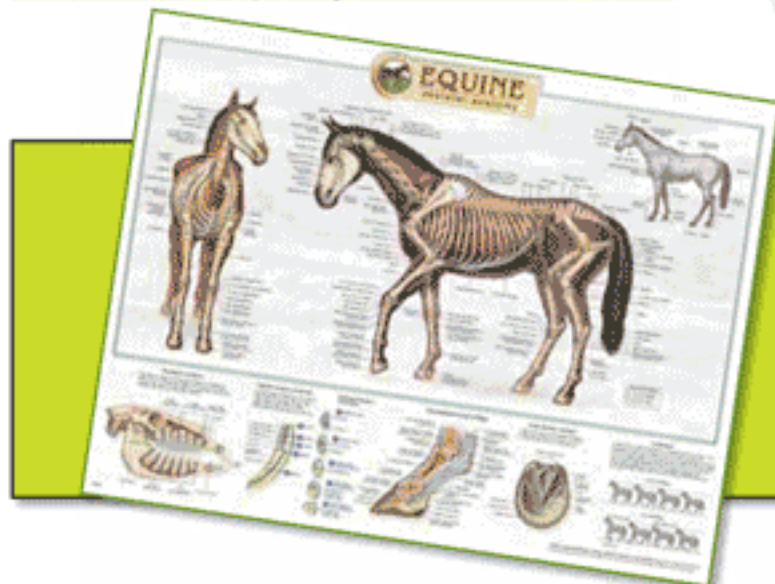

Equine Skeletal Anatomy Chart

Produced by Anatomical Chart Company, these scientific and medical illustrations are designed in consultation with veterinarians and zoologists to develop charts illustrating the anatomy, systems, structures, diseases and conditions of a horse. Each chart measures 26" by 20" and is printed on high quality heavy paper with your choice of flexible lamination and rigid lamination.

8701-PL1.5 26"x 20", Flexible \$22.95/ea

Ivermectin Paste

RXIVER-PAST 1.87%, 6.08gm \$3.70/ea



Flea Life-Cycle Model

JOR777 \$45.95/ea



Cryosurgery in Horses handbook

JOR811M Cryosurgery in Horses handbook \$30.00/ea

Chondrogen EQ

RXCHON-EQ-75 150 dose powder, 75oz

\$115⁰⁰/ea



Pharmaceutical Prices Subject Change Please Call before ordering

13822 WEST BOULTON BLVD. METTAWA, IL 60045

WWW.SHOPMEDVET.COM

Phone 800-544-7521

333

Fax 800-204-2177



Pill Splitter, Bottle Closures & Culture Tubes

Pill Splitter

Many tablets or pills are too large for smaller veterinary patients. There is a need to precisely split pills for accurate dosing. This pill splitter has a thin razor-sharp blade that cuts the pill cleanly. The "V"-shaped trough holds a variety of pill sizes. Lightweight blue plastic can be easily cleaned.

JOR696 \$5.40/ea



DELUXE Pill Splitter

- An improved pill splitter for more precise and cleaner cuts. Additionally, larger nonstandardized pills fit.
- Flexible arms and cutting base with soft rubber material that holds pills more securely in place
- See through design assists user to visually align pill prior to splitting
- Molded polycarbonate with double-beveled German-made steel blade

JOR698 \$6.00/ea



Pill Splitter/Crusher

This handy device will either split or crush a tablet. Has a storage case on the bottom.

JOR696 Blue \$16.70/ea



StaySafe - Self-Sealing Bottle Closures

This patented product allows a luer slip syringe to repeatedly withdraw oral liquids from plastic amber pharmacy bottles. The Stay Safe is pressed into bottle opening. StaySafe Closures feature flexible sealing rings for compatibility with a range of bottle sizes. Size 24 fits snugly into most bottles with necks in its I.D. (inner diameter) range of 15.5mm - 18.25mm. Bottles should be selected for smooth inside necks sized with the stated inner diameter range. A smooth neck optimizes the ability of the closure to provide an effective seal.

JOR1080 24mm/50 Pack \$41.00/ea



Universal Bottle Adapter **JorVet**

This adaptor features a graduated rubber plug that fits bottle openings 18-22mm. The lethered plug lets you reseal the bottle for later use. Attach oral dose syringe and withdraw desired dose.

JOR578 fits bottle openings 18-22mm, /5pk \$8.70/ea

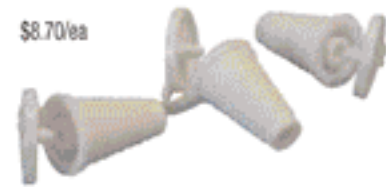

Jorvet AI Pipettes

- | | | |
|-----------|--|-----------|
| JOR102D2 | Small Animal, 6", 4pk | \$2.10/pk |
| JOR102D2A | Small Animal, 25pk | \$6.50/pk |
| JOR102D3 | Long Canine, 9" 9". With blue syringe adapter. Pack of 12. Nonsterile. | \$3.60/dz |

BULL Semen Collection Cones

JOR102D1 AI Latex Cone, X-Large size. \$13.65/ea



Cage Card Holder

Stainless steel card holder that fits most brands of stainless steel cages by sliding tightly onto cage bars

JOR461X Stainless Steel ID Card Holder \$6.00/ea
Standard 3 x 5



Sterile Culture Tubes

Transparent polystyrene tubes can be used for most routine laboratory procedures. Tubes are supplied with a 2-position ribbed polyethylene cap which can be left open for aerobic work or sealed for anaerobic work. 25/bag.

JOR556A 5 ml, 25/bag \$5.40/bg
JOR556B 16ml, 25/bag \$6.90/bg



Scalers

Delmarva 2000 Ultrasonic Scaler with Motor Pack

6 year warranty

Ultrasonic Tooth Scaler features:

- Automatic tuning: it recognizes and locks in on each insert.
- Powerful 25k magnetostrictive frequency.
- Programmed power control knob provides optimum energy for all inserts.
- Exclusive 25% power increase for extra boost.
- Accepts all Cavitron style 25k inserts.
- Specialty insert power setting for feline urethral catheters and other inserts.
- Unique low water pressure warning light.

Motor Pack features:

- Speeds of 3000 to 22000 RPMs-wide range for polishing or drilling.
- Foot switch allows hands free operation.
- Hand piece is a sealed unit which generates no heat and requires no lubrication.

DE-1N Includes: Detachable scaler hand piece, Plug-in Micro Motor Hand Piece, 1 TFI 3 insert, 12 prophy cups, 12 prophy paste, 1 prophy angle, In-line water filter, quick release valve, 6 year warranty \$2,077.00/ea

Delmarva 2000 Ultrasonic Scaler

- Automatic tuning: it recognizes and locks in on each insert.
- Powerful 25k magnetostrictive frequency.
- Programmed power control knob provides optimum energy for all inserts.
- Exclusive 25% power increase for extra boost.
- Accepts all Cavitron style 25k inserts.
- Specialty insert power setting for feline urethral catheters and other inserts.
- Unique low water pressure warning light.

Includes: Detachable scaler hand piece, 1 TFI 3 insert, In-line water filter, quick release valve.

DE-2 Includes: Detachable scaler hand piece, 1 TFI 3 insert, In-line water filter, quick release valve \$1,535.00/ea

Delmarva 2000 Motor Pack

- Use for polishing, drilling, cutting, rounding...any fine surface procedures.
- Speeds of 3000 to 22000 RPMs-wide range for polishing or drilling.
- Foot switch allows hands free operation.
- Hand piece is a sealed unit which generates no heat and requires no lubrication.

DE-3 Includes: Screw-in micro motor hand piece, 12 prophy cups, 12 prophy paste, and 1 prophy angle \$974.00/ea

Dental Handpiece Lubricant

JOR841LA 8oz spray \$62.00/ea



JorVet Ultrasonic Scaler

Our new magnetostrictive ultrasonic scaler has a sleek design with a small footprint size.

- Operates on 25KHZ
- Includes 2 inserts, one universal and one spatula tip.
- Unique LED display, same as JOR842x
- Foot pedal operation
- 6 year limited warranty
- Dimensions: 6 1/2"W x 9"L x 3 1/2"H
- Weight: 3 lbs 14 oz.



JOR842Q Accessories JOR452D2 & JOR452D1P \$755.00/ea

Piezoelectric Ultrasonic Scaler

Piezoelectric ultrasonic scalers differ from the conventional ultrasonic scalers. The piezo handpiece generates its ultrasonic waves via four ceramic plates subjected to high frequency alternation current. The electric mechanical efficiency of this system is much greater than that of traditional magnetostrictive systems.

There is very little heat released and it is possible to work with very little water spray. All available in a sleek, contemporary design with an operation frequency of 29KHZ. Foot pedal operation; unique LED display that indicates the power level that will best perform endo, periodontal work, or scaling. 6 year limited warranty (90 days on tips, 2 years on handpiece).

JOR842X 6.5" x 9" x 3.5", 4 tips included: 2 universal, 1 spatula and 1 periodontal. \$795.00/ea

Piezo Scaler Tip

These tips are for use with the piezo ultrasonic scaler.

JOR842XD2 Spatula tip \$42.00/ea
 JOR842XD1 Universal tip \$42.00/ea
 JOR842XD3 Periodontal tip \$42.00/ea



Piezo Ultrasonic Scaler Handpiece

This is a replacement handpiece.

JOR842XD4 each \$209.00/ea

Wrench for Piezo Scaler Tips

JOR842XD5 \$29.00/ea

Super Soft Blue Ultrasonic Insert

JOR842MD1 25KHZ \$144.00/ea
 JOR842MD2 30KHZ \$147.00/ea

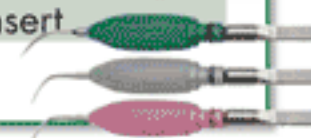

Jorvet Trace Disclosing Solution

This solution will stain a tooth surface bright cherry red if plaque is present. Some Suggested uses:

- A client education aid to show extent of patient plaque
 - Evaluation of home tooth brushing effectiveness
 - Follow-up to dental prophy to make sure procedure was complete
- Simple to use: swab an area with moistened cotton tip applicator. 2 oz dispensing bottle with screw cap.

JOR969 60ml \$11.40/ea



Scalers/Polishers

JorVet Combo Piezo Dental Unit

Our scalers differ from the conventional ultrasonic scalers. The piezo handpiece generates its ultrasonic waves via four ceramic plates subjected to high frequency alternating current. The electric mechanical efficiency of this system is much greater than that of traditional magnostriuctive systems. There is very little heat released and it is possible to work with very little water spray.

- Sleek contemporary design
- Operation frequency 29KHZ
- 4 tips included, 2 universal, 1 spatula and 1 periodontal
- Unique LED display indicates the power level that will best perform endo, periodontal work, or scaling.
- Foot pedal operation
- 6 year limited warranty (90 days on tips, 2 years on handpiece).
- Dimensions: 6 1/2" W x 9" L x 3 1/2" H

Weight: 3 lbs. 14 oz.

JorVet

JOR841X ACCESSORIES AND REPLACEMENT PARTS: JOR842XD1, \$1,281.00/ea
JOR842XD2, JOR842XD3, JOR842XD4, JOR842XD5



JorVet Combo Ultrasonic Dental Unit

This is our new dental combo unit with a sleek design and affordable price! It is the workhorse your hospital needs!!

- Contemporary design with a small footprint
- Operation frequency 25kHz
- Includes in-line water filter, 2 inserts (1 spatula, 1 universal), micro-motor, polisher handpiece, prophylaxis angle, prophylaxis cups and paste starter kit
- Comes with quick release attachment for water tank set-up (optional water tank JOR452D4)
- Large, easy to read LED power display
- Micromotor variable speed 2,000-30,000 rpm with forward/reverse
- Foot pedal operation
- Optional drilling and sectioning attachments available
- 6-year limited warranty (90 days on inserts and prophylaxis angle, 1 year on the handpiece)
- Dimensions: 6" L x 8" W x 3.5" H
- Weight: 6.5 lbs.

JorVet

JOR841Q 110v \$1,210.00/ea



Combo Ultrasonic Dental Unit

Magnostriuctive ultrasonic scaler/polisher, 25K. Compact unit comes with 2 inserts, prophylaxis angle, polishing cups and paste.

JOR841QV 220v \$1,170.00/ea

JorVet



Soft Tissue Protector **JorVet**

Soft Tissue Protector. Fits polishing head of a dental unit.

JOR41ST Cross Cut Burr Sold Separately \$105.00/ea

X-long Cross Cut Burr **JorVet**

Extra-Long Cross Cut Burr. For use with above soft tissue protector.

JOR41CC Soft Tissue Protector Sold Separately \$10.00/ea



Jorvet Pro Scale Polishing Unit **JorVet**

- 300-30,000 rpm
- 1:1 straight handpiece
- Metal prophylaxis angle, forward & reverse functions
- Starter kit includes prophylaxis paste and polishing cups
- Extra disposable prophylaxis angles
- Operates from either foot switch or push-button control
- May be used with optional diamond cutting discs, contra angle, and diamond burs
- 12-month warranty

JOR453 110 Volt \$670.00/ea
JOR453A 220 Volt \$650.00/ea



Scaler/Polisher Accessories

Rubber Cups **JorVet** for Polishing (A)

JOR452D6 Rubber, 100/PK \$13.00/pk

Screw-On Prophylaxis Cups

"S"-Shaped Hand Rasp. This is especially useful as a finishing tool on the upper premolars.

JOR452D5 100 pack \$22.50/pk
JOR452D6S 100 pack \$14.10/pk

Prophylaxis Polishing Paste (B) **JorVet**

Flavored, Grey with fluoride. Offered in a large bulk container or pack of 100

JOR452D5B Bulk, 12oz Container \$18.30/ea

Ultrasonic Insert Spatula Tips (C) **JorVet**

JOR452D2 \$81.00/ea
JOR452D1P \$81.00/ea

Prophylaxis Paste Ring

JOR452D5R Not Pictured \$6.45

Diamond Cutting Disc (D)

Diamond cutting disc for trimming incisors, fits directly into the JOR841 handpiece.

JOR452D7 Fits into Handpiece \$36.00/ea

Metal Prophylaxis Angle (E)

Dental Accessories & all dental inserts are compatible with other manufacturers of Cavitron dental scalers. **JorVet**

JOR452D3 slip fit \$32.10/ea

Contra Angle (F) **JorVet**

Diamond cutting disc for trimming incisors, fits directly into the JOR841 handpiece.

JOR452D9 Friction Grip \$143.00/ea

Portable Water Tank (G)

Dental Accessories & all dental inserts are compatible with other manufacturers of Cavitron dental scalers. **JorVet**

JOR452D4 1-gallon, Ea \$63.00/ea

Handpiece Cord **JorVet**

JOR452HP \$105.00/ea NOT SHOWN



Diamond Disc Safety Shield

JOR41SS Safety shield only \$105.00/ea

Rodent & Small Animal Dental

Jorvet Rabbit/Rodent Dental Starter Kit

A convenient cost saving kit that gets the practitioner started with the basics for this expanding field. **Jorvet**

JOR51RK KIT INCLUDES: \$200.00/ea
 MOUTH GAG
 CHEEK DILATORS LARGE
 CHEEK DILATORS SMALL
 RODENT DENTAL MOLAR CUTTERS
 RODENT MOUTH SPATULA
 MOLAR RASP FOR "FLOATING" TEETH
 INSTRUMENT STORAGE TRAY



Rodent Mouth Gag

Examination of the rabbit mouth is virtually impossible without a gag of this type.

JORGENSEN JOR51RG \$75.00/ea



Jorvet Rabbit/Rodent Dental Head Support

If you are serious about rabbit/rodent dentistry, this is the piece of equipment you need. This special device is designed for hands-free dental work on smaller pocket pets and rabbits. The support tilts to various angles. Two metal posts hold a mouth speculum via thin metal adjustable bars. This also serves to hold the animal's head steady and the mouth open to exactly the desired size. Fiber composite base.

JOR931 12cm W x 19-27cm H x 23cm D. \$395.00/ea



Rabbit Speculum LED Light

JOR931A Stand Sold Separately \$148.00/ea



Rodent Molar Cutter **Jorvet**

Used to deflect tongue and cheeks to enable best possible view of problems.

JOR51RM \$105.00/ea

JOR41MC \$48.00/ea



Rodent Dental Spatula **Jorvet**

Used to deflect tongue and cheeks to enable best possible view of problems.

JOR51RS \$24.00/ea



Jorvet Rodent Cheek Dilator

The cheek dilator allows visualization of molars and protects cheeks from instruments.

JOR51RDLX Large with long reach \$21.00/ea

JOR51RDS Small, Also useful as a gag for guinea pigs and chinchillas. \$21.00/ea



Jorvet Rodent Molar Extractor

Used to deflect tongue and cheeks to enable best possible view of problems. **Jorvet**

JOR41ME \$48.00/ea



Rodent Tooth Rasp

Molar Rasp (rabbits). Unsuitable for debulking but good for removal of small spurs.

JORGENSEN JOR51RR \$60.00/ea



Dental Wedge

The use of a mouth gag or speculum is a common procedure in small animal medicine. Maintaining an open mouth is a requirement for many dental cases and for proper examination of the upper airways. The wedge is a clear plastic mouth prop that features:

- Anatomic design for proper, secure placement between premolars and molars
- Radiolucent for unobstructed radiographs
- Autoclavable
- A hole is provided to attach a suture for emergency removal
- Can be used if canine teeth are absent
- Soft and pliable for patient comfort.
- Suggested uses: intubation, oral surgery, dental procedure, oral exam, radiographic exam **Jorvet**



JOR51Q Small \$19.50/ea

JOR51R Large \$19.50/ea



Rodent Cheek Dilator

JOR51RDL Large \$21.00/ea



Root Tip Pick **Jorvet**

Heid Brink tooth ejector. Sometimes during extraction, tooth fragments can break off and remain in the socket. This instrument has a thin delicate tip that helps loosen and remove those remaining fragments.

JOR42X \$19.50/ea



Jorvet Lightweight Rodent Mouth Gag

Smaller with less bulk than standard rodent gag. Knurled knob adjusts opening.

JOR51RGS \$60.00/ea



Nazzy Ferret Mouth Gag **Jorvet**

A smaller version of the feline gag. This works very well on ferrets, kittens, and small puppies.

JOR51G 1 1/8" \$35.00/ea

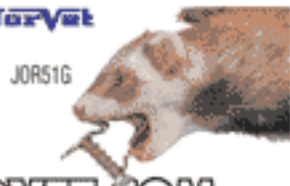

Mouth Gags Propy Kits

Mouth Gags

| | | | |
|---------------|--------|-------|------------|
| GERMAN | 33-281 | 2.5" | \$19.00/ea |
| | 33-282 | 3" | \$19.00/ea |
| | 33-283 | 4.5" | \$19.00/ea |
| | 33-284 | 5.75" | \$19.00/ea |
| | 33-285 | 6.75" | \$19.00/ea |

Canine Gag

Spring action with nylon inserts for less trauma.
Three sizes available.

| | | |
|---------|-----------------------|------------|
| JOR51A | Small, 4 1/2" | \$12.90/ea |
| JOR51B | Medium, 5" | \$12.90/ea |
| JOR51C | Large, 6 3/4" | \$12.90/ea |
| JOR51D1 | Inserts, Pair, Canine | \$3.30/ea |

Smith-Baxter Mouth Gag

Gag. For large dogs. Stainless steel.

| | | |
|----------|---------|------------|
| JOR51SBA | Small | \$15.00/ea |
| JOR51SBB | Medium | \$15.00/ea |
| JOR51SBC | Large | \$18.00/ea |
| JOR51SBD | X-large | \$21.00/ea |

Feline Gag

Small and lightweight.

| | | | |
|------------------|----------|-----------------------|-----------|
| JORGENSEN | JOR51F | Stainless Steel, 3" | \$9.90/ea |
| | JOR51FD1 | Inserts, Pair, Feline | \$3.30/ea |



Prophylaxis Dental Kit

| | | | |
|-----------|---|-------------|----------------|
| DENT-ECON | Includes Probe, 2x Scalers, Curette, Mirror | \$24.00/ea | ECONOMY |
| DENT-MIL | Includes Probe, 2x Scalers, Curette, Mirror | \$125.00/ea | MILTEX |

Small Animal Basic Propy Kit

This kit is designed to provide complete instrumentation for dental cleaning and examination. The following 6 German instruments are included in the kit: Dental Mirror, Jacquette Scaler 2s/3s, Jacquette Scaler 6s/7s, Columbia Curette c2l/c2r, Mocal's Curette 11/12, and an Explorer/Measuring Probe.

| | | |
|--------|----------------------|--------------|
| JOR41K | 6 German Instruments | \$105.00/set |
|--------|----------------------|--------------|



Small Animal Rainbow Propy Kit

This kit contains all the instruments needed for doing the proper dental examination and cleaning.

The kits has the following features:

- Cryogenically-treated 440A-USA stainless steel is guaranteed harder, tougher and will hold it's edge 2-7 times longer than competitor's.
- Ultra-large handle for premium comfort combined with the light weight instrument reduces risk of Carpal Tunnel Syndrome
- Exclusive extended knurling pattern gives you maximum control for leverage as well as torque.
- Anatomically color-coded to speed up set-ups and pick-ups.
- Kit comes with a sterilization cassette tray useful for sterilization and storage.

Instruments included are:

- (1) Mirror #4, (1) Explorer #2, (1) Explorer/Probe 23/12, (1) Jacquette Scaler 2s-3s, (1) Jacquette Scaler 6s-7s, (1) Columbia Curette 4r-4l, and (1) Columbia Curette 13-14.

JOR973N 7 instruments, Tray and Dental Chart. Instruments available in Propy Kit or Individually.

\$230.00/set

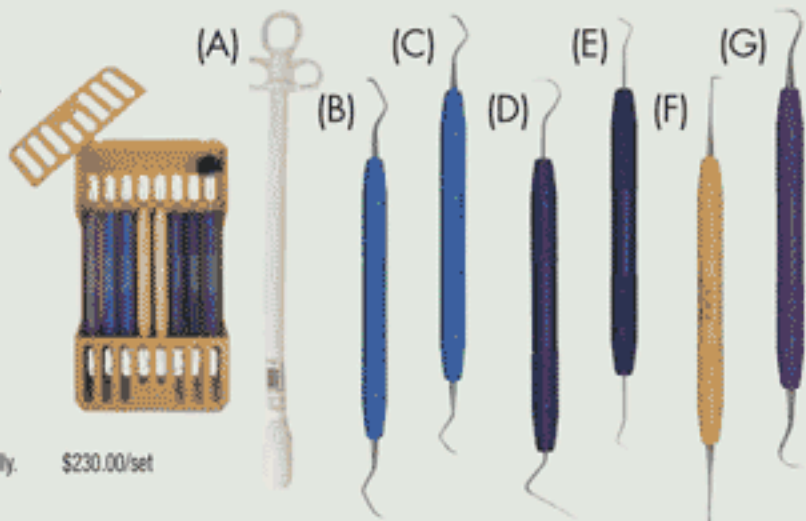

Rainbow Blue Dental Mirror #4 (A)

| | | |
|----------|--------------------------------|------------|
| JOR973A | Diagnostic: Visual Inspection. | \$17.80/bx |
| JOR973AN | Diagnostic: Visual Inspection. | \$21.00/ea |

Rainbow Columbia 4R-4L Curette (B)

| | | |
|----------|---------------|------------|
| JOR973FN | Nautical Blue | \$32.00/ea |
|----------|---------------|------------|

Rainbow Columbia 13-14 Curette (C)

| | | |
|----------|---------------|------------|
| JOR973GN | Nautical Blue | \$32.00/ea |
|----------|---------------|------------|

Rainbow Dental Explorer/Probe (D)

| | | |
|----------|--------------|------------|
| JOR973CN | Pacific Blue | \$28.00/ea |
|----------|--------------|------------|

Rainbow Explorer #2 (E)

| | | |
|----------|--------------|------------|
| JOR973B | Pacific Blue | \$19.60/ea |
| JOR973BN | Pacific Blue | \$34.50/ea |

Rainbow Jacquette 34-35 (F)

| | | |
|----------|----------------|------------|
| JOR973DN | Rainbow Yellow | \$32.00/ea |
|----------|----------------|------------|

Sickle Scaler 204S (G)

| | | |
|----------|-----------------|------------|
| JOR973EN | Sunshine Purple | \$32.00/ea |
|----------|-----------------|------------|

Curettes, Files & Rasps

Jorvet Crossley Molar Luxator

Designed to facilitate extraction of molars with a minimum of damage to the alveolus and surrounding soft tissue. One cutting blade is for insertion down buccal or lingual surface. The other end of the instrument is set at right angles to penetrate between molars.



JOR41MR \$45.00/ea 

Jorvet Crossley Rabbit Incisor Luxator

Incisor malocclusion with resulting over growth is a common and serious problem in rabbits. Frequent clipping is required with the risk of splitting the incisors. Extraction is the only permanent solution but the roots of the incisors are large relative to the jaw. The Crossley incisor luxator was designed especially for this procedure. The instrument matches the shape of the rabbit incisor. It is double ended for various size incisors. Complete with instructions for use.



JOR41CR \$45.00/ea 

Columbia Curette

Designed to remove subgingival calculus. To root plane, use short quick overlapping strokes.

JOR41E Double Ended, C2L/C2R \$24.00/ea
 JOR41EA Double Ended, 13, 14 ss \$21.00/ea

Dental Files

| Vendor | Item# | Details | Price |
|---------------|--------|------------|------------|
| GERMAN | DBFH12 | Howard #12 | \$12.95/ea |
| | DF64 | Miller #64 | \$9.95/ea |
| | DFFP | FPS34 | \$12.47/ea |

Dental Extraction Kit

D-EXTRACT 7 instruments \$90.50/pk



Dental Prophylaxis Kit

D-PROPHY 5 instruments \$39.95/pk

Dental Curette

MIL70-50

Curettes are used to remove subgingival calculus, for root planing and for curettage. They have one blade with two cutting edges. Both cutting edges may be used on the front and back of the tooth.

| Vendor | Item# | Details | Price |
|-----------------------|----------|--------------|------------|
| ECONOMY | DB#5/6 | Barnhart 5/6 | \$9.95/ea |
| | DG7/8 | Gracey 7/8 | \$9.95/ea |
| Integra/Miltex | MIL70-50 | #13/14 D/E | \$27.69/ea |



McCall's Curette

Designed to remove subgingival calculus. To root plane, use short quick overlapping strokes.

JOR41F Double Ended, 11,12 \$22.50/ea

Double Ended Subgingival Curette

Gracey style. Subgingival curette for important removal of necrotic debris below the gumline. Often overlooked but necessary for proper dental care. England.

JOR42S Stainless steel, 6". \$15.00/ea 

Diamond Molar Rasps

Unsuitable for debulking, but good for tidying. The diamond rasp's surface is concave to fit over the molars without slipping off. Diamond grit is the ideal material to remove tooth spurs without damaging the delicate root structure.

| | | |
|---------|---|------------|
| JOR41GF | Molar Rasp-fine, For guinea pigs & chinchillas. | \$36.00/ea |
| JOR41R | Rasp, Molar For Rabbits | \$36.00/ea |
| JOR41RF | Fine Diamond | \$69.00/ea |

Explorers/Probes

| Vendor | Item# | Details | Price |
|-----------------------|------------|------------------|------------|
| ECONOMY | DPPE | Explorers/Probes | \$7.95/ea |
| | DEX5 | Explorer #5 | \$2.00/ea |
| | DWPP | PERIOSTIAL PROBE | \$8.95/ea |
| Integra/Miltex | MIL69-6337 | Probe/Explorer | \$27.32/ea |

Pet Dental Care Products Available in our Pet & Grooming Section



Elevators

Dental Elevators



| Vendor | Item# | Details | Price |
|------------------|------------|----------------------|------------|
| GERMAN | D#34 | #34 3/16 | \$9.95/ea |
| | D#34S | #34S 1/8 | \$9.95/ea |
| | D#46 | #46 3/32 | \$9.95/ea |
| | D#78 | #78 Root Tip | \$12.95/ea |
| | D#301 | #301 1/16 | \$12.95/ea |
| MILTEX | MILDEL-34 | #34 3/16 | \$66.48/ea |
| | MILDEL-34S | #34S 1/8 | \$66.48/ea |
| | MILDEL-46 | #46 3/32 | \$66.48/ea |
| | MILDEL-78 | #78 Root Tip | \$66.48/ea |
| | MILDEL-301 | #301 1/16 | \$66.48/ea |
| JORGENSEN | JOR43M | Medium, Straight 3mm | \$13.20/ea |

Canine Dental Elevator (A)

| | | | |
|--------|---|------------|--|
| JOR41A | Small, Cats and fractured tooth tips. 2mm head. 6". | \$44.00/ea | |
| JOR41B | Medium, Mid-sized dogs. 3mm head. 6". | \$54.00/ea | |
| JOR41C | Large, Large dogs and K-9 teeth. 4mm head. 6". | \$54.00/ea | |

Delicate Feline Dental Elevator

JOR897Q #301 pattern \$25.50/ea



Winged Dental Elevator

| Vendor | Item# | Details | Price |
|------------------|---------|-----------------|------------|
| GERMAN | WE1 | 1mm Wide | \$15.95/ea |
| | WE2 | 2mm Wide | \$15.95/ea |
| | WE3 | 3mm Wide | \$15.95/ea |
| | WE4 | 4mm Wide | \$15.95/ea |
| | WEF | V-SHAPE, Feline | \$17.95/ea |
| JORGENSEN | JOR897A | 1mm Wide | \$25.50/ea |
| | JOR897B | 2mm Wide | \$25.50/ea |
| | JOR897C | 3mm Wide | \$25.50/ea |

Set of 4 Winged Dental Elevators

JOR897S \$79.00/ea



Periosteotome

JORGENSEN JOR899 6" L \$18.00/ea

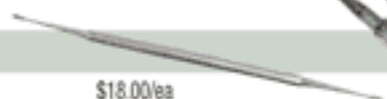

Wolftooth Elevator Set

This attractive professional looking kit has six different instruments to help elevate any size of wolf tooth.



Different elevators:

- 5mm sharp concave point with rounded backside, 6" length
- 5mm sharp concave point with a curved head, 6" length
- Large 9mm concave sharp head, 6" length
- Longer, heavier handle with a 5mm slightly curved deep concave head, 9" length
- Longer, heavier handle 5mm deep concave head, 9" length
- 9mm concave curved replaceable head on ergonomic curved heavy handle, 8" length
- All in handy, padded black zipper pouch with red velvet lining

JOR43Y \$99.00/ea

JorVet



Wolftooth Elevator Set

Two different head sizes allow this instrument to "cap" the wolf tooth. By rotating clockwise and counter clockwise, the tooth can be separated from the alveolus. Angulated head is useful on teeth that are set well back.



JOR43AB Stainless Steel. 1/4" and 3/8" Heads. \$110.00/ea

Wolftooth Elevator

The length of the blade can be shortened or lengthened as desired by loosening the set screw with the wrench.

JOR43W \$22.50/ea



Deluxe Wolf Tooth Elevator

JOR709 with Ergonomic Handle., 22cm L. \$94.00/ea



Double End Elevator 4mm **JorVet**

This double-ended elevator has a unique veterinary design. The fine tips are both curved with an elevator groove. One end of the groove is on the inside concave side and the other end of the groove is on the outside convex side. This allows the elevator to follow the large root curves which exist on many animal teeth (i.e., deciduous canine teeth).

JOR42Y Stainless Steel Knurled 7 1/4" L handle. \$33.00/ea



Dental Elevator with Notched "V" Tip.

Holds dental burrs into a convenient and easy to see block. The magnetic base holds up to 14 burrs securely. Drain holes prevent rusting. Non-slip feet add stability. Autoclavable. Cover sold separately.

| | | |
|---------|---------------------------------------|------------|
| JOR899A | Elevator tip on outside of curved tip | \$24.00/ea |
| JOR899B | Elevator tip on inside of curved tip | \$24.00/ea |
| JOR899C | Elevator tip on inside of curved tip | \$24.00/ea |
| JOR899D | Elevator tip on inside of curved tip | \$24.00/ea |
| JOR899S | Set of all 4 | \$76.00/ea |



Dental Supplies

Explorers, Mirrors, Scalers & Scrapers



Explorer/Measuring Probe

The delicate explorer tip is used for increased tactual sensitivity in the gingival sulcus. It locates subgingival calculus and can be used to check tooth mobility. The periodontal measuring probe is graduated in millimeters. It is held parallel to the long axis of the tooth and measures gingival sulcus depth.

JOR420 6 1/2" \$27.00/ea



Mouth Mirrors



| Vendor | Item# | Details | Price |
|----------------|-------|---------|-----------|
| ECONOMY | DCDM | Size 4 | \$8.95/ea |

Dental Mirror **Jorvet**

JOR41MI Dental Mirror. 22mm (7/8") dia. \$9.00/ea

Integra/Miltex Dental Mirror Handle

MIL67-685 #3 \$40.62/ea



Percussion Chisel

Dental Chisel with sliding bar or percussion handle. The working end has a notched "V". It works great for removing upper premolar hooks and lower rear molar hooks. Stainless steel.

JOR701 23" L, collapsed \$168.00/ea



S-Flated Hand Rasp **Jorvet**

"S"-Shaped Hand Rasp. This is especially useful as a finishing tool on the upper premolars.

JOR702 Tungsten carbide. 30cm L. \$99.00/ea



Jacquette Scaler

Designed to remove supragingival calculus with sharp pull strokes. The scaler tip is triangular in shape with a sharp tip.

| Vendor | Item# | Details | Price |
|-----------------------|-----------|-----------------------|------------|
| GERMAN | D2Y/3Y | Jacquette 2Y/3Y | \$7.95/ea |
| Integra/Miltex | MIL70-100 | Jacquette 2/3 | \$34.08/ea |
| | MIL70-126 | 6/7-Octagonal, D/E | \$33.23/ea |
| JORGENSEN | JOR41J | Double Ended, 2, 3 ss | \$24.00/ea |
| | JOR41J | Double Ended, 2, 3 ss | \$24.00/ea |
| | JOR41JA | Double Ended, 6, 7 | \$22.50/ea |

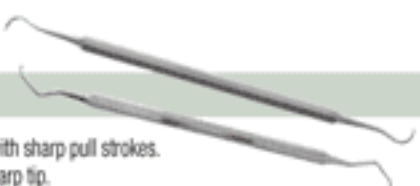

Periodontal Scaler Jacquette

| Vendor | Item# | Details | Price |
|-----------------------|----------|--------------------------------------|------------|
| Integra/Miltex | MIL70-94 | Jacquette scaler 1Y/1YS Double Ended | \$27.69/ea |
| | MIL70-96 | 4 3/4", 2y/3y, Periodontal | \$27.69/dz |

Periodontal Scalers

| Vendor | Item# | Details | Price |
|----------------|-------|---------------|-----------|
| ECONOMY | DH6/7 | Sickle, H6/7 | \$7.95/ea |
| GERMAN | DS2/3 | Jacquette 2/3 | \$7.95/ea |

Tartar Scrapers

| Vendor | Item# | Details | Price |
|-----------------------|-----------|---------------------|------------|
| ECONOMY | D#3 | #3 Octagonal, S/E | \$12.95/ea |
| Integra/Miltex | MIL70-108 | #3 Octagonal, S/E | \$28.40/ea |
| | MIL70-110 | #12 D/E | \$33.23/ea |
| | MIL70-116 | Whiteside-Octagonal | \$27.69/ea |
| | MIL70-120 | 15/30-Universal D/E | \$33.23/ea |

Dental Scraper **Jorvet**

JOR42J #6. Stainless steel. 6"L. \$4.50/ea



Canine Tartar Scraper

| Vendor | Item# | Details | Price |
|-----------------------|------------|--|------------|
| ECONOMY | D#12 | #12 | \$9.95/ea |
| Integra/Miltex | MIL60-50/2 | Curved/Straight Edge | \$25.57/ea |
| | MIL60-50/4 | Triangle | \$24.93/ea |
| JORGENSEN | JOR42A | Triangular, Stainless steel. 5 3/4" | \$4.80/ea |
| | JOR42B | Double-end curved ends with angular edges, Stainless steel. 6 3/4" | \$21.00/ea |

Stainless Probe

11-1280 Mail Probe \$3.00/ea

Dental Supplies

Burs, Tooth Cutters & Germicide

Rabbit Burr-Kit

JOR41RK Bit only 3pk \$95.00/pk



Extra Long Cross Cut Burr J41RK

JOR41RXL Bit only, for JOR41RK \$15.00



Taper Side Cut Burr

JOR41RKT Bit only, 2.3mm, for JOR41RK, Bit only, for JOR41RK \$15.60/ea

Round Burr Only for JOR41RK

JOR41RKR Bit only Bit only, for JOR41RK \$15.00/ea

Diamond Dental Burr

Diamond Dental Burs. Seven. Use with contra angle. Includes handy display tray.

JOR452D8M Set of 7 \$52.50/pk



Dental Burr Block

Jorvet

Holds dental burs into a convenient and easy to see block. The magnetic base holds up to 14 burs securely. Drain holes prevent rusting. Non-slip feet add stability. Autoclavable. Cover sold separately.

JOR944 Holds up to 14 burs \$18.90/ea

Clear Cover for Dental Burr Block

JOR944C Clear. Not autoclavable, use only with cold sterilization. \$7.50/ea



Dental Hand Instrument Tray

Organizes and stores up to six hand instruments. Autoclavable up to 270 degrees fahrenheit. Caution do not use dry heat

JOR943 3.625" x 7.75" \$11.40/ea



Tooth Punch-Straight

The punch is used for removal of cheek teeth through a trephined hole into the sinus. A knurled handle gives a better grip. A round head with a slight recessed area fits better onto the tooth. Stainless steel.

JOR712 20cm L. \$39.00/ea

Jorvet



Tooth Cutter Jorvet

Molar Cutter. The most effective design of a molar cutter has a parallel alignment of the jaws to the tooth surface. This allows the whole tooth to be trimmed, not just at the narrow point of attachment. The jaws of this instrument are a special hardened tempered steel. Knurled handles for a non-slip grip.

JOR707 Straight-56cm \$675.00/ea

JOR708 Angled-56cm \$795.00/ea



Twitch Jorvet

Kendall model. Complete with tie rope.

JOR44 Stainless steel, 13". \$13.50/ea



JOR43RU



JOR43RL



Reynold's Equine Tooth Extractor Jorvet

This is the recommended instrument for retained deciduous teeth (caps) in horses. Also works for small premolars and incisors.

JOR43RU Upper Jaw. Stainless steel. 15"L (38cm). \$93.00/ea

JOR43RL Lower Jaw. Stainless steel. 15"L (38cm). \$93.00/ea



Pig Tooth Nipper

JOR42H Nickel-plated. 5 1/2"L. \$15.00/ea

JOR42HS Stainless steel. 5 1/2"L. \$8.80/ea



Jorvet Pink Germicide

An inexpensive disinfectant that allows the submerged instrument to be quickly used after just 10 minutes. It has an anti-corrosive agent that makes it safe to use with stainless steel instruments.

Germicide's advantages:

- Quaternary ammonium compound
- Fast acting
- Low Toxicity
- Ready-to-use, no dilution needed

JOR883 One Gallon \$16.50/yl



13822 WEST BOULTON BLVD. METTAWA, IL 60045

WWW.SHOPMEDVET.COM

Phone 800-544-7521

342

Fax 800-204-2177

Extractors & Forceps

Wolftooth Extractor Set

Stainless steel.

JOR711 Comes in convenient canvas case. \$290.00/ea



Wolftooth Extractor Forcep

Wolftooth Extractor Forceps. Stainless steel.

JOR43H 11 1/2"L. \$45.00/ea



Dental Forceps



JOR42D



JOR42F



JOR42G

| Vendor | Item# | Details | Price |
|------------------|-----------------------|-------------------|-------------|
| ECONOMY | D#150S | #150 1/2S, 4 3/4" | \$19.95/ea |
| | D#151 | #151, 6 1/2" | \$24.00/ea |
| | D#6 | Split/Separate | \$24.00/ea |
| | D#62 | #62, 6 1/2" | \$19.95/ea |
| | D#65 | #65 | \$24.00/ea |
| | D#120 | K9/Cat, 6" | \$24.00/cs |
| | Integra/Miltex | MILDEF-120 | K9/Cat, 6" |
| MILDEF-150S | | #150 1/2S, 4 3/4" | \$121.30/ea |
| MILDEF-151 | | #151, 6 1/2" | \$153.31/ea |
| MILDEF-6 | | Split/Separate | \$153.31/ea |
| MILDEF-62 | | #62, 6 1/2" | \$153.31/ea |
| MILDEF-65 | | #65 | \$153.31/ea |
| MILDEF-H | | Small Breed | \$184.71/ea |
| JORGENSEN | | JOR42D | 7"L |
| | JOR42F | 7"L | \$22.50/ea |
| | JOR42G | 7"L | \$22.50/ea |

Heavy Calculus/Tarter Removal Forceps

Very heavy deposits of calculus often develop on the carnassial and other teeth. It is preferred to remove these large hard deposits with this instrument rather than using an ultrasonic scaler or an expensive orthopedic rongeur.

JOR898A Small. 4 1/2"L. \$48.00/ea

JOR898B Large. 5 1/2"L. \$48.00/ea

JOR898S Set of two \$86.00/ea



Angled Tooth Fragment Forcep

A perfect instrument for broken tooth fragments or small delicate teeth such as cat incisors. Angled.

JOR899T 4 3/4"L. \$24.00/ea

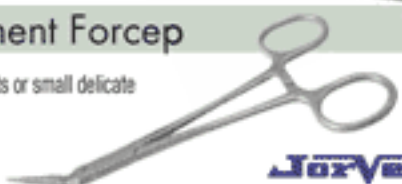

JorVet

Extraction Forceps JorVet

Universal Small Tooth Extracting Forceps.

JOR705 Stainless steel. 17"L. \$564.00/ea



Small Extracting Forceps Kit

Useful for small wolf teeth and tooth fragments. One forceps is useful for spreading incisors before extraction. Set of three forceps configured with varied angled heads make it easier to extract wolf teeth or fragments out of tight spots.

JOR42K 7" length. \$92.00/ea



Feline Dental Extractor JorVet

Smaller Feline Dental Extractor with spring loaded handles.

JOR42R Stainless steel. 4 1/2". \$39.00/ea



This extractor is smaller and lighter weight with special jaws that close together along their whole interface. Especially designed for small dog and feline teeth or tooth fragments. Also useful in removing tartar/calculus.

JOR42T Made in England. 6". \$33.00/ea



Three Root Extracting Forceps

JOR1092 Three root extraction forceps, On side 21" \$180.00/ea

JOR1092A Three root extraction forceps, Off side 21" \$180.00/ea

Three Root Extracting Forceps (Mini)

JOR1092B Smaller version in length and forceps head size, On side 12" \$140.00/ea

JOR1092C Smaller version in length and forceps head size, Off side 12" \$140.00/ea

Four Root Dental Extraction Forceps

JOR1093 21" \$180.00/ea

JOR1093A Mini 12" \$140.00/ea



Deciduous Incisor Tooth Extractor

Spring handle increases holding power. Stainless Steel.

JOR703 20cm L. \$552.00/ea

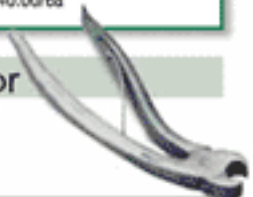

Deciduous Incisor Tooth Extraction Forceps

Deciduous Premolar "Cap" Extraction Forceps. Designed by Dr. Stetzer, German-made high quality forceps. Slightly curved.

JOR704 Stainless steel. 17"L. \$550.00/ea

JorVet



Short/Narrow Jaw Molar Extractor Forceps

Serrated short jaw creates good purchase on cheek and premolar retained deciduous teeth.

JOR43B \$180.00/ea



JorVet

Cochran Dental X-ray Positioner

Small animal dental radiography is vital to the successful diagnosis and treatment of dental disease. However, obtaining accurate intra-oral films can be challenging unless the proper techniques are used. Bisecting Angle Imaging is a well-established technique in both human and veterinary dentistry. With this approach, even the most difficult to reach teeth are properly radiographed. The patented COCHRAN BISECTING ANGLE DENTAL X-RAY POSITIONER will help veterinarians and technicians get excellent quality films each time. What is A Bisecting Angle? - In any 90-degree arc there is one angle at which an X-ray beam will accurately shadow the tooth on film. This is the bisecting angle: the bisection of the long axis of the tooth and the angle of the film. The X-ray beam is directed perpendicular to the bisecting angle for the perfect undistorted image.

FEATURES AND BENEFITS

- Perfect for any teeth, especially
 - Canine teeth
 - Maxillary Premolars and Molars
 - Incisors, especially maxillary
- No more film taped to tongue depressors or forceps that must be hand-held or "propped up" for filming
- Set the angle, lock in place, and step out safely for radiographing
- Virtually eliminates hand motion and blurring of the film
- Elongation, shortening, overlapping of teeth and surrounding structures eliminated or greatly minimized with the bisecting angle technique
- May be used with beam limiting devices (cones) and standard collimator heads
- Accommodates standard film, Computed (CR) film, and Digital (DDR) film
- Lightweight for easy handling, will not add pressure on patients' mouths

JOR1008 \$220.00/ea

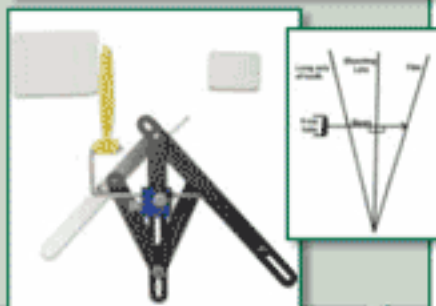

Jorvet Equine Dental Fulcrum

Use as a fulcrum to gain leverage in conjunction with a molar extraction forceps when extracting large cheek teeth.

JOR705F Dual End, 22" (54cm) L. \$232.00/ea



Jorvet Dental X-ray Film Mounts

Veterinarians are increasingly using specific dental x-ray machines. A dental x-ray unit uses very small dental film and requires multiple film pieces. This small film is difficult to store and catalog correctly. The dental film mounts help solve this problem.

| | | |
|---------|--|------------|
| JOR977 | Handy dispenser box containing 1,000 mounts for 500 pairs in vertical side-by-side format. You tear off as many as needed. | \$44.00/ea |
| JOR977A | Side-by-side, 100pk | \$14.50/pk |
| JOR977B | Four mounts in a horizontal row, 100pk of fours. | \$20.50/pk |

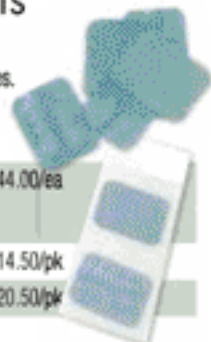

Equine Dental Instruments

A large dental patient like a horse needs oversized equipment. These dental probes, scalers, and explorers are giant sized to 19" with knurled handles. If you do a lot of equine dentistry, you are going to find them very useful.

| | | |
|---------|---|-------------|
| JOR440 | Explorer or Shepherd's Hook | \$36.00/ea |
| JOR440A | Sickle Shaped Scaler | \$36.00/ea |
| JOR440B | Sickle Shaped Scaler-Heavy | \$36.00/ea |
| JOR441 | Dental Probe Heavy Tip, Calibrated probe is used to measure depth of periodontal pockets | \$39.00/ea |
| JOR441A | Dental Probe Fine Tip, Finer calibrated tip for pulp horns and tooth surface pockets on the occlusal surface of cheek teeth. | \$42.00/ea |
| JOR441B | Periodontal Forceps, 41cm (16.4"). Heavy-duty right angle forceps is useful for removing forage or debris from periodontal pockets. | \$106.00/ea |



EquiVet Dental Pick

JOR939 Stainless Steel, Sharp, 19", 48cm \$52.00/ea

EquiVet Parellel Gingival Elevator

JOR939B Stainless Steel, 19", 48cm \$54.00/ea



EquiVet Perpendicular Gingival Elevator

JOR939A Stainless Steel, 19", 48cm \$55.50/ea



Equine Instruments



EquiVet Cheek Retractor (A)

Pulls the cheek gently away from the cheek teeth so occlusion can be evaluated on a closed mouth. Also useful for providing more room when power float equipment is being used. By turning retractor around, you get two sizes. **Jorvet**

JOR938 Stainless Steel \$52.00/ea

EquiVet Dental Mirror (B)

Large mirror angled at 30°. "T" shaped handle. Large mirror angled at 30°. "T" shaped handle. **Jorvet**

JOR938M 19" length \$67.00/ea

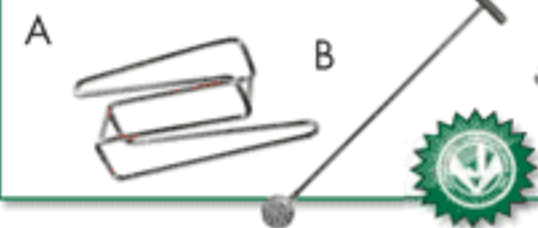

EquiVet Cap Forceps w/Flexible Head (C)

EquiVet Cap Forceps with flexible head. This cap retained deciduous teeth removal forceps gives a better grip as the heads swivel to fit the actual shapes of the cap. Universal for both upper and lower jaws.

JOR43X Stainless Steel \$198.00/ea **Jorvet**

Equine Universal Dental Extraction Forceps (D)

Designed by Dr. Seltzer. High-quality. German-made.

JOR706U \$657.00/ea **Jorvet**

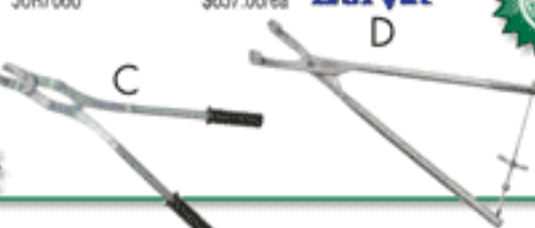

Equine Molar Cutter (E)

Powerful compound action. Breakdown model for easy storage.

JOR42 Stainless steel. 11 1/2" handle. 25"L. \$180.00/ea

Jorvet

Equine Molar Forcep (F)

Designed by Dr. Seltzer. High quality. German-made.

JOR43 Stainless steel. 17 1/2" \$75.00/ea

Jorvet



Trephine Set

JOR706TS (handle and 3 heads) Not Pictured \$395.00/ea

Trephine Handle Only

JOR706THH Not Pictured \$76.00/ea

Trephine Head Only

For Larger Head Sizes Not Pictured

| | | |
|-----------|------|-------------|
| JOR706THL | 25mm | \$120.00/ea |
| JOR706THM | 22mm | \$120.00/ea |
| JOR706THS | 19mm | \$120.00/ea |

Horasley's Trephine

Horasley's Trephine.

| | | |
|---------|----------------|------------|
| JOR161A | Complete, 1/2" | \$48.00/ea |
| JOR161B | Complete, 3/4" | \$48.00/ea |
| JOR161C | Complete, 1" | \$48.00/ea |

Equine Sinus Trephine

2" The trephine has been designed for use on a modified frontonasal sinus flap surgery.

JOR161E 2" \$145.00/ea

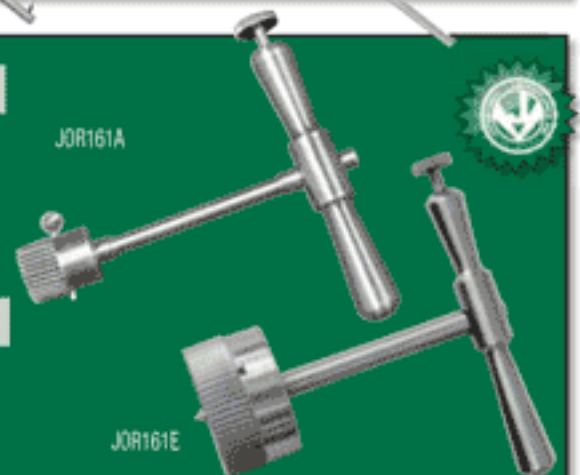

Premium Float Line

These floats are a quality crafted stainless steel float line with many new configurations to employ the newest techniques in equine dental care.

- Flat shaft provides visualization for blade orientation
- Lightweight and precision balanced
- Foam non-slip hand grip, colored coded end
- Large Allen head set screw
- Fits standard flat float blades
- Combined with (JOR57) hardened carbide float blade makes for the finest floating equipment available
- Blade not included **Jorvet**



| | | |
|---------|--|-------------|
| JOR496 | Straight molar float 13 1/2" | \$120.00/ea |
| JOR496A | Excellent for rear molars. 13 1/2" shaft. | \$120.00/ea |
| JOR496B | Angle or Obtuse Float. For use on upper arcade molars. 11 1/2" shaft. | \$120.00/ea |
| JOR496C | Premolar Float with short right angle shaft. Especially effective on premolar hooks and special "bit" requirement. | \$120.00/ea |

Specialty designed for dropping over and onto the last molar and removal of hooks that can develop on the caudal edge of that tooth.

JOR496D Rear Molar Float, 13 1/2"L shaft \$120.00/ea

Jorvet Carbide Float Blade

These blades take alot of the work out of floating a horse's teeth. The carbide metal is very hard and gives a razor sharp edge. This is the new standard in equine dentistry. Blade can be re sharpened 3 times. Available in 3 different grits: fine, medium, and coarse. Medium is the most common grit used. Fits any standard flat headed float. Short Flat Blade for specialized floats (i.e., bit seat float).

| | | |
|---------|---|-------------|
| JOR57 | Medium Grit, 3 1/4" x 1". | \$101.00/ea |
| JOR57C | Coarse grit, 3 1/4" x 1". | \$101.00/ea |
| JOR57SF | Fine Grit, 2 1/4" x 1". | \$80.00/ea |
| JOR57F | Fine Grit, 3 1/4" x 1". | \$101.00/ea |
| JOR57S | 2 1/4" x 1". Medium Grit, Short, Medium, 2 1/4" x 1". | \$86.00/ea |



Equivet Carbide Magnetic Float Blade

| | | |
|---------|--------|------------|
| JOR57XF | Fine | \$70.00/ea |
| JOR57XM | Medium | \$70.00/ea |

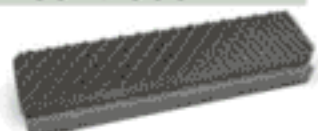

Equivet Floats and Magnets



Equivet Magnet Floats

Flat Float Blade with tungsten carbide chips fits any standard float.

| | | |
|----------|---|-------------|
| JOR1048A | Upper cheek #8-11 | \$107.00/ea |
| JOR1048B | Lower Cheek #6-11 | \$107.00/ea |
| JOR1048C | Upper and Lower Last Molar #1 | \$107.00/ea |
| JOR1048D | Upper and Lower Tooth Molar #6 or pre-molar roller for creating a bitseat | \$107.00/ea |
| JOR1048E | Upper Premolar #6-8 | \$107.00/ea |
| JOR1048F | Up and Lower Incisors #1-4 | \$107.00/ea |
| JOR1048G | Convex float for occlusive surface | \$104.00/ea |
| JOR57Y | Carbide blade for JOR1048g | \$136.00/ea |
| JOR57XM | Medium | \$70.00/ea |
| JOR57XF | Fine | \$70.00/ea |



JOR1048F



JOR1048E

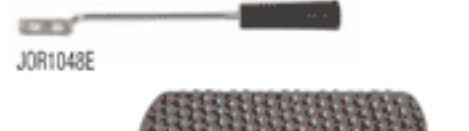

JOR1048E



JOR1048G



JOR1048C



JOR1048A



JOR1048B

House Combination Dental Float

House Float Straight Shaft only.

JOR58HS Straight Shaft, Less Blade \$18.00/ea



JOR58HS

Proctor Float

Proctor Float makes it easy to float the first two premolars. Tungsten carbide chips.

JOR58P 12" L \$27.00/ea



JOR58P

Dental Float w/Pistol-Grip

Holds dental burrs into a convenient and easy to see block. The magnetic base holds up to 14 burrs securely. Drain holes prevent rusting. Non-slip feet add stability. Autoclavable. Cover sold separately.

Rasps, Straight - Complete

| | | |
|---------|---|-------------|
| JOR935 | Rasp, Straight Head, 30cm | \$152.00/ea |
| JOR935A | Rasp, Straight Head, 42cm | \$158.00/ea |
| JOR935H | Straight Float Head for Pistol-Grip Float | \$76.00/ea |

Rasps, Angled-Up Head - Complete

| | | |
|---------|---|-------------|
| JOR936 | Rasp, Angled-Up Head 30cm | \$152.00/ea |
| JOR936A | Rasp, Angled-Up Head 42cm | \$158.00/ea |
| JOR936H | Replacement Angled-Up Rasp Head only. 1" W x 2" | \$76.00/ea |

Rasp, Angled-Down Head - Complete

| | | |
|---------|--|-------------|
| JOR937 | Rasp, Angled-Down head 30cm | \$152.00/ea |
| JOR937A | Rasp, Angled-Down head 42cm | \$158.00/ea |
| JOR937H | Replacement Angled-Down Rasp Head, 1" W x 1 3/4" L | \$76.00/ea |
| JOR937S | Contains JOR937H and JOR937x Angled-Up, and Angled-Down 30cm Rasps. Six different configurations, with both lengths of pistol grip shafts. | \$386.00/ea |

Dental Float w/Pistol-Grip

| | | |
|---------|-------------------------------|------------|
| JOR937X | Pistol grip handle only, 30cm | \$76.00/ea |
| JOR937Y | Pistol grip handle, 42cm | \$82.00/ea |



House Combination Dental Floats

| | | |
|---------|---|------------|
| JOR58HC | Standard Dental Float with both straight and angled shaft with one interchangeable handle. 20" L. | \$54.00/ea |
| JOR58HS | Straight shaft, less blade | \$18.00/ea |
| JOR58HA | House Float Angle Shaft only. | \$18.00/ea |
| JOR58HH | House Float Interchangeable Handle only | \$21.00/ea |
| JOR58HQ | Float with handle and Straight Shaft. | \$36.00/ea |
| JOR58HZ | Float handle with Angle Shaft. | \$36.00/ea |

Thomsen's Universal Dental Float

Float head is hinge attached, making this float universal for upper and lower molars. Float blade is concave from side to side, stays on dental surface. Long lasting tungsten carbide blade.

| | | |
|---------|---|------------|
| JOR58CT | Curved Float Blade with tungsten carbide chips, fits universal float. | \$24.00/ea |
| JOR58L | 26" | \$58.50/ea |
| JOR58S | 20" | \$54.00/ea |

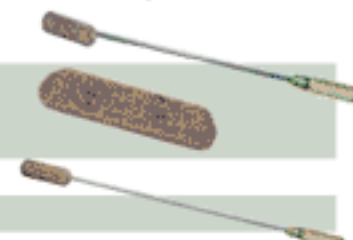

Flat Float Blade (Tungsten Carbide)

Flat Float Blade with tungsten carbide chips fits any standard float.

JOR58FT 1" x 3 1/4" \$18.55/ea





The Lone Star Veterinary Retractor System

The Lone Star Veterinary Retractor System consists of two components, the autoclavable plastic ring and the accessory elastic stays. Because of its unique design, the retractor ring easily can be adapted to the patient's anatomy. The elastic stays allow the surgeon flexibility over the amount of tension applied and precise retraction of the incision without obstruction. Prep and drape patient in usual manner, then apply the retractor.

JOR4407 Retractor Ring Only, Small \$119.00/ea



AccuJack Ejaculator **Jorvet**

The control box has the newest electronics and features both automatic and manual settings. The automatic cycle is adjustable over a range of time settings. The level of stimulus can also be set by the operator. The self-contained battery holds the longest charge of any ejaculator available. The probe is a segmented design. The concept is simple. Stimulus is applied to a smaller area inside the bull via a segmented length of the probe. The target ganglia can be more precisely stimulated versus the motor control nerves. This will help avoid the bull going down in the chute and severe muscular spasms. The stress on the animal is greatly reduced and knockdown is very unlikely. This saves time by not having to retest bulls. More segments of the probe can be activated by just flipping additional switches. The probe head is heavily weighted on the ventral side to keep it down. The cord plug-in is a bright orange and extends 6" beyond the end of the probe yoke.

Kit includes:

- Case constructed of heavy-duty virtually unbreakable material
- Collection handle
- JOR102d1 latex reusable cone
- JOR102d9 disposable cones. 100/pk.
- Instruction manual
- Segmented probe

JOR750 Complete unit \$2,520.00/ea



Killian Speculum

Killian Vaginal Speculum for dogs. Has set screw and 3 1/2" blades. Stainless steel.

JOR52K \$18.00/ea

Jorvet



Equine Eye Lid Speculum

JOR68EE \$53.00/ea

Graefe Eyelid Speculum

JOR68GW German \$54.00/ea

Jorvet



Polansky Speculum

Polansky Vaginal Speculum with 3 blades. Has butterfly screw with 2 blades on top for wide exposure. 26cm (10 1/2").

JOR52P 3 blades, 11" \$90.00/ea

Jorvet



Thoroughbred Speculum

JOR52T 28cm (11"). \$60.00/ea

Thumb Speculum

JOR700 \$66.00/ea **Jorvet**



Jorvet Equine Chain Twitch

Chain twitch with plated chain with 25" flat wooden handle.

JOR44A 5" dia loop \$32.50/ea



Equine Semen Extender (w/Antibiotics)

This is the all natural product of glucose and non-fat dry milk. It is recommended for all artificial insemination purposes. The semen may be cooled for extended storage periods for transport. It may also be used for same day breeding on the farm with or without antibiotics. Each kit contains the component parts in a hermetically sealed pouch and a separate 150ml wide-mouth bottle of sterile water.

JOR124Q Amikacin and K-Penn. 10 kits/box. \$88.00/pk

Semen Extender (w/o Antibiotics)

JOR124N 10-pk \$70.50/pk

Dr. Kenney Stallion Semen Ext. (w/antibiotics)

(w/antibiotics) Amikacin and K-Penn. 150 ml dose - Includes water and dry components pouch.

JOR124T 10 units. \$88.00/ea

(w/o antibiotics) 150 ml dose - Includes water and dry components pouch.

JOR124S 10 units. \$70.50/ea



Equine Express Semen Transport Case

Transporting cooled stallion semen across long distances has been made possible by special transport shippers. This shipper has a cardboard outer shell with 2" thick Styrofoam liner. A special coolant pack is included along with two non-spermicidal 50cc syringes. The package has been approved by both FedEx and UPS. It also is a USDA-APHIS approved container for biological material.

Jorvet

JOR125 14" x 8" x 10", 31/2 lbs. \$51.75/ea



Drenchers/Feeders & Infusion Pumps

Jorvet Drencher

These drenchers allow for administration of large doses often necessary to treat adult cattle. The use of oral calcium or propylene glycol drenches are easier with large drencher.

- Curved nozzle with olive tip
- Clear barrel to see medication
- High-impact plastic handle

JOR640 300 ml \$82.50/ea

Drencher (Barrel only) Jorvet
JOR640D2 300cc barrel only \$25.20/ea

Drencher (O Ring Only) Jorvet
JOR640D1 O ring for 300 ml \$4.80/ea

Drencher
JOR641 200 ml \$73.50/ea

Drencher (Barrel Only) Jorvet
JOR641D2 Barrel only 200ml. \$18.00/ea

Drencher (Oring Only)
JOR641D1 "O" Ring for 200ml. \$4.50/ea

Drencher (Piston only)
JOR641D5 Piston for 200 ml \$9.00/ea

Jorvet Oral Calf Drencher

Unit Measurements in mL, cc., Pints & Ounces Left-Hand Side
Measurement for Hanging Up Right-Hand Side Measurement for
Stand Alone

JOR138GB Stainless Steel Esophageal Probe \$18.00/ea

JOR138CP Stainless steel esophageal probe with a rounded end cap. \$16.50/ea



Speedy Feeder Speedy Calf Feeder

Three-speed calf bottle was developed in New Zealand and is widely sold worldwide. It is especially useful for weak or premature calves that cannot nurse properly. The Speedy Calf feeder features: simple switch had 3 "speeds" to adjust flow, x-fast for aggressive nursers, x-slow for eak calves, easygrip can be used comfortably in several positions, cap mounted low to help empty bottle completely, wide 3" diameter neck for easier filling and cleaning, capacity of 2.5 liters, wide base lets bottle stand easy.

JOR1022 \$28.50/ea



Oral Calf Feeder

This familiar style of semi-rigid container has a screw-on cap with a plastic esophageal probe with a rounded end cap. Measurements are marked on the container.

JOR138C Semi-Rigid, Holds 3 Pints \$9.00/ea

JOR138CP Stainless steel esophageal probe with a rounded end cap. \$16.50/ea

Large 1 gallon container. Plastic esophageal probe style same as JOR138c. Added air vent.

JOR138G 1 gallon \$12.60/ea



Jorvet Bovi-Vet Calf Drencher

A safe and quick method for oral liquid therapy in calves.

JOR137M 2-liter container \$23.70/ea



Flux Rumen Infusion Pump

Flux Rumen Infusion Pump. Administering oral fluids in the very large volumes needed for a full sized bovine can be a challenge. Volumes of 40 liters (12 gallons) or more need to be delivered quickly. The Flux pump was developed to meet this need.

- The brass pump has a large stroke volume both during the up and down movements.
- Connects via a standard garden hose quick-release fitting
- Heavy-duty spring metal tubing can withstand chewing
- Length of 1.7 meters marked to show positive placement into the rumen. The combination of proper length plus heavy-duty chewing resistant tubes makes an attached nose long unnecessary. Some suggested uses:
- Propylene glycol with calcium given immediately postpartum in dairy cows
- Water: down cows get dehydrated quickly
- Various energy and electrolyte "cocktails"
- Inoculation of rumen contents from a healthy donor animal

JOR901 40 liters (12 gallons) \$410.00/ea

Pump (only for Flux Rumen Kit)

Selekt Cattle Pump is a newly developed and field tested stomach pump from Denmark. This new pump allows large volumes (1 1/2 gallon) of fluids to be administered safely by one person in just two minutes. The Selekt pump has a large oral tube (3.25m) that passes deep into the esophagus to avoid placement errors. A heavy-duty outer tube that the cow can chew on protects the wire-reinforced tube. An attached nasal tong helps hold the tube in position while pumping. The lightweight plastic pump is placed into a 5-gallon bucket (not included). A heavy-duty quick release system links the pump to the stomach tube. Instructional CD is available.

JOR901P \$140.00/ea

Flux Rumen

JOR901PR Less Pump \$294.00/ea



Rumen Collector Transfer Kit

Optional transfer setup consists of: Additional tubing for second passage

JOR900RTS Additional oral speculum and nose tongs \$760.00/ea

Calf Nipple (with Cap)

This red rubber nipple attaches to the JOR138c oral calf feeder bottle.

JOR138N Attaches to the JOR138c \$1.28/ea



Equine Uterine Infusion Pipette w/adaptor

An equine specific 25" pipette with extra-large bore adaptor to allow quicker infusion. Individually wrapped. Sterile. 25/case. (Syringe not included.)

JOR284 25", 25pk \$18.00/pk

Probang with Extractor

JOR120 64", For removal of Beets from Bovine esophagus For removal of Beets from Bovine esophagus \$362.00/ea

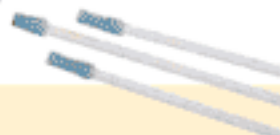

Large Animal Supplies

Pumps, Prods & Rings/Leads

Enema or Oral Calf Feeder Bag

This bag was originally developed for enemas on larger patients. It has also found use as an oral calf feeder. Plus, it is less expensive. Short rigid end probe: helps ease passage. Round probe end with side port: helps prevent occlusion.

JOR139 3000 cc capacity \$6.00/ea



JorVet Thirsty Stomach Pump

The pump is very lightweight plastic, but durable for all weather use. The "Thirsty" pump has a stroke volume of eight ounces and delivers fluid on both up and down

strokes. The pump has two adaptors for stomach tube attachments. The smaller adaptor attaches foal and small tubes. The larger adaptor attaches medium and large stomach tubes.

JOR136 \$51.90/ea



Drench Pump

Drench Pump for administering large doses of fluid orally. A continuous flow pump that puts out liquid on both the up and down stroke.

| | | |
|----------|------------------------------------|------------|
| JOR132 | Pump | \$69.00/ea |
| JOR132D1 | Felt Washer | \$2.55/ea |
| JOR132D2 | Rubber O-Ring | \$2.70/ea |
| JOR132W | Leather Washer, Pair (washer only) | \$15.80/pr |

JOR132



Barne's Dehorner

Heavy-duty dehorner. Steel handles with rubber grips. Heat-treated steel cutting blades.

| | | |
|---------|--------------------|------------|
| JOR182 | Wooden Handle, 12" | \$33.00/ea |
| JOR182M | Metal Handle, 17" | \$48.90/ea |



Tube Dehorner

| | | |
|---------|---------|------------|
| JOR295C | 1" O.D. | \$10.50/ea |
| JOR295A | 3/4" | \$7.50/ea |
| JOR295B | 7/8" | \$9.00/ea |



Hauptner Clipper

Large animal. For clipping when no electricity is available.

| | |
|---|------------|
| JOR59 | \$78.00/ea |
| Extra Blades for Hauptner Hand Clipper. | |
| JOR59D | \$42.00/pr |



Sheep Hand Shearer

Sheep trimming shears. Red enameled handles. 6" blades.

JOR360 \$21.00/ea



Jorvet Prod with Batteries

This is the popular Dutch prod; a sturdy prod with a strong shock.

JOR1 Includes 2 "D" batteries. 9"L. \$69.00/ea



Jorvet Prod Extension Handle

Extension Handle for electric shocker (JOR1).

JOR1E Extends total length to 36". \$27.00/ea



Rumen Magnets

This traditional style is solid metal with rounded ends. Features a polished metal finish with slightly roughened ends. Alnico style.

JOR309H 3"L, 12/box. \$24.00/dz

Rectangle Magnet with rounded beveled edges. A coat of nylon plastic covers an inner ceramic magnet. The most powerful magnet offered. It will pick up 25 percent more nails than other designs.

JOR309K 3"L, 12/box. \$21.60/dz

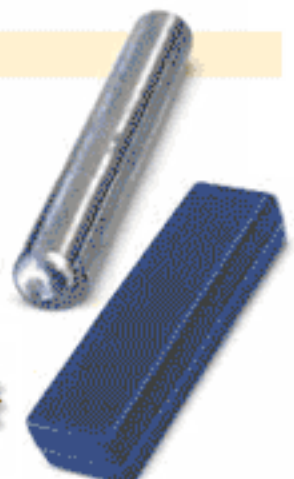

Bull Lead (with Chain, No Hooks)

JOR178B With chain, No hooks. \$24.00/ea

(without Chain or Hooks)

JOR178AB Without Chain or Hooks. \$18.90/ea



Bull Ring

2 1/2" i.d. This new polished steel bull ring is much stronger than brass. The special sharp cutting points pierce the nasal septum easily with no pre-incision. Screw and screwdriver combined. Break screwdriver off after insertion.

JOR3 Steel, 3", 2 1/2" i.d. \$6.30/ea

JOR3C Copper-Brass, 3" \$6.00/ea



Harm's Bull Lead

JOR178H Overall 10", Stainless steel \$15.00/ea



Bull Lead

Spring-loaded lead closes in animal's nose. Useful in moving or transport of animal. Nose piece measures 2" x 3" across center dia.

JOR178 Overall 5" \$15.00/ea



Dental Forceps, Extractors & Elevators



Equine Molar Forcep

Designed by Dr. Seltzer. High-quality. German-made.
JOR43 Stainless steel. 17 1/2" \$75.00/ea



JorVet

Equine Universal Dental Extraction Forceps

JOR706U \$657.00/ea



JorVet

EquiVet Cap Forceps w/Flexible Head

EquiVet Cap Forceps with flexible head. This cap retained deciduous teeth removal forceps gives a better grip as the heads swivel to fit the actual shapes of the cap. Universal for both upper and lower jaws.

JOR43X Stainless Steel. \$198.00/ea



JorVet

Deciduous Incisor Tooth Extractor

Spring handle increases holding power. Stainless Steel.
JOR703 20cm L. \$552.00/ea



JorVet

Deciduous Incisor Tooth Extraction Forceps

Deciduous Premolar "Cap" Extraction Forceps. Designed by Dr. Stetzer, German-made high quality forceps. Slightly curved.

JOR704 Stainless steel. 17"L. \$550.00/ea



JorVet

Reynold's Equine Tooth Extractor

This is the recommended instrument for retained deciduous teeth (caps) in horses. Also works for small premolars and incisors.

JOR43RU Upper Jaw. Stainless steel. 15"L (38cm). \$93.00/ea
JOR43RL Lower Jaw. Stainless steel. 15"L (38cm). \$93.00/ea



Extraction Forceps

Universal Small Tooth Extracting Forceps.
JOR705 Stainless steel. 17"L. \$564.00/ea



EquiVet Dental Irrigation Pick

This specially designed dental pick uses pressurized water irrigation through a long thin metal tube with a right angle end. Very useful in cleaning of inter-dental spaces and periodontal pockets. Connects to a water tank that, with a few simple pumps, creates a pressurized flow.

JOR939X \$224.00/ea



Equine Dental Fulcrum

Use as a fulcrum to gain leverage in conjunction with a molar extraction forceps when extracting large cheek teeth.

JOR705F Dual End. 22" (54cm) L. \$232.00/ea

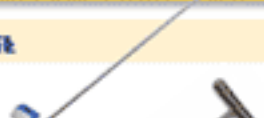

EquiVet Dental Mirror

Large mirror angled at 30°. "T" shaped handle.
JOR938M 19" length \$67.00/ea



JorVet

S-Floted Hand Rasp

"S"-Shaped Hand Rasp. This is especially useful as a finishing tool on the upper premolars.
JOR702 Tungsten carbide. 30cm L. \$99.00/ea



JorVet

Premium Float Line

These floats are a quality crafted stainless steel float line with many new configurations to employ the newest techniques in equine dental care.

- Flat shaft provides visualization for blade orientation
- Lightweight and precision balanced
- Foam non-slip hand grip, colored coded end
- Large Allen head set screw
- Fits standard flat float blades
- Combined with (JOR57) hardened carbide float blade makes for the finest floating equipment available
- Blade not included

| | | |
|---------|--|-------------|
| JOR496 | Straight molar float 13 1/2" | \$120.00/ea |
| JOR496A | Offset Molar Float, 13 1/2" shaft. | \$120.00/ea |
| JOR496B | Angle or Obtuse Float. For use on upper arcade molars. 11 1/2" shaft. | \$120.00/ea |
| JOR496C | Premolar Float with short right angle shaft. Especially effective on premolar hooks and special "bit" requirement. | \$120.00/ea |



Specially designed for dropping over and onto the last molar and removal of hooks that can develop on the caudal edge of that tooth.

JOR496D Rear molar float, 13 1/2" L shaft \$120.00/ea

EquiVet Dental Rasps Protector

Designed to fit or be inserted into JOR398b stainless steel bucket. Separates and protects rasps while soaking in the bucket.

JOR496DRP \$77.00/ea



Dental Floats

Thomsen's Universal Dental Float

Float head is hinge attached, making this float universal for upper and lower molars. Float blade is concave from side to side, stays on dental surface. Long lasting tungsten carbide blade.

| | | |
|---------|---|------------|
| JOR58CT | Curved Float Blade with tungsten carbide chips, fits universal float. | \$24.00/ea |
| JOR58L | 26" | \$58.50/ea |
| JOR58S | 20" | \$54.00/ea |



Flat Float Blade (Tungsten Carbide)

Flat Float Blade with tungsten carbide chips fits any standard float.

| | | |
|---------|-------------|------------|
| JOR58FT | 1" x 3 1/4" | \$18.55/ea |
|---------|-------------|------------|



Proctor Float

Proctor Float makes it easy to float the first two premolars. Tungsten carbide chips.

| | | |
|--------|-------|------------|
| JOR58P | 12" L | \$27.00/ea |
|--------|-------|------------|



Short Flat Float Blade

| | | |
|---------|--|------------|
| JOR57SF | Fine Grit, 2 1/4" x 1" | \$80.00/ea |
| JOR57S | 2 1/4" x 1", Medium Grit, Short, Medium, 2 1/4" x 1" | \$86.00/ea |

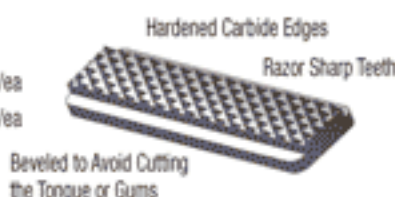

Beveled to Avoid Cutting the Tongue or Gums

Convex Blade for JOR1048G only

| | | |
|--------|----------------------------|-------------|
| JOR57Y | Carbide Blade for JOR1048G | \$136.00/ea |
|--------|----------------------------|-------------|

T-Handle Blade Punch

| | | |
|----------|--|------------|
| JOR1048T | | \$30.00/ea |
|----------|--|------------|



Equivet Magnet Floats

A totally new approach to a float blade attachment to the handle. These floats have a magnetic head that holds securely, the solid carbide blade. The blades can be removed with a "T" bar handle punch. The blades are a very sharp solid carbide with rounded corners. Hollow shaft lightens weight. The shaft is flattened at its attachment to the handle. This gives the operator orientation on the blade location.

| | | |
|----------|---|-------------|
| JOR1048A | Upper cheek #8-11 | \$107.00/ea |
| JOR1048B | Lower Cheek #6-11 | \$107.00/ea |
| JOR1048C | Upper and Lower Last Molar #1 | \$107.00/ea |
| JOR1048D | Upper and Lower Tooth Molar #6 or pre-molar roller for creating a bitseat | \$107.00/ea |
| JOR1048E | Upper Premolar #6-8 | \$107.00/ea |
| JOR1048F | Up and Lower Incisors #1-4 | \$107.00/ea |
| JOR1048G | Convex float for occlusive surface | \$104.00/ea |

JOR1048 Series



Equivet Carbide Magnetic Float Blade

These blades are a very sharp solid carbide with rounded corners. Hollow shaft lightens weight. The shaft is flattened at its attachment to the handle. This gives the operator orientation on the blade location.

| | | |
|---------|--------|------------|
| JOR57XF | Fine | \$70.00/ea |
| JOR57XM | Medium | \$70.00/ea |

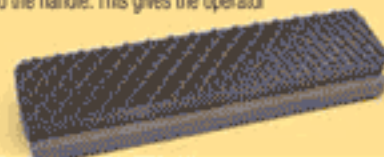

House Combination Dental Float

| | | |
|---------|---|------------|
| JOR58HA | House Float Angle Shaft only. | \$18.00/ea |
| JOR58HS | Straight Shaft, Less Blade | \$18.00/ea |
| JOR58HZ | Float handle with Angle Shaft. | \$36.00/ea |
| JOR58HQ | Float with handle and Straight Shaft. | \$36.00/ea |
| JOR58HH | House Float Interchangeable Handle only | \$21.00/ea |
| JOR58HC | Standard Dental Float with both straight and angled shaft with one interchangeable handle. 20" L. | \$54.00/ea |



Dental Float w/Pistol-Grip

| | | |
|---------|--|-------------|
| JOR935 | Rasp, Straight Head, 30cm | \$152.00/ea |
| JOR935A | Rasp, Straight Head, 42cm | \$158.00/ea |
| JOR935H | Straight Float Head for Pistol-Grip Float | \$76.00/ea |
| JOR936 | Rasp, Angled-Up Head 30cm | \$152.00/ea |
| JOR936A | Rasp, Angled-Up Head 42cm | \$158.00/ea |
| JOR936H | Replacement Angled-Up Rasp Head only. 1" W x 2" | \$76.00/ea |
| JOR937 | Rasp, Angled-Down head 30cm | \$152.00/ea |
| JOR937A | Rasp, Angled-Down head 42cm | \$158.00/ea |
| JOR937H | Replacement Angled-Down Rasp Head, 1" W x 1 3/4" L. | \$76.00/ea |
| JOR937S | Contains JOR937H and JOR937x Angled-Up, and Angled-Down 30cm Rasps, Six different configurations, with both lengths of pistol grip shafts. | \$386.00/ea |
| JOR937X | Pistol grip handle only, 30cm | \$76.00/ea |
| JOR937Y | Pistol grip handle, 42cm | \$82.00/ea |



Carbide Float Blade

These blades take alot of the work out of floating a horse's teeth. The carbide metal is very hard and gives a razor sharp edge. This is the new standard in equine dentistry. Blade can be resharpened 3 times. Available in 3 different grits: fine, medium, and coarse. Medium is the most common grit used. Fits any standard flat headed float. Short Flat Blade for specialized floats (i.e., bit seat float).

| | | |
|--------|--------------------------|-------------|
| JOR57C | Coarse grit, 3 1/4" x 1" | \$101.00/ea |
| JOR57 | Medium Grit, 3 1/4" x 1" | \$101.00/ea |
| JOR57F | Fine Grit, 3 1/4" x 1" | \$101.00/ea |



Large Animal Dental



Jorvet Equine Speculum Dental Light

The Equivet dental light attaches to any brand of full mouth speculum using incisor plates (i.e., McPherson and Meister speculums). It floods the entire mouth with high intensity halogen light. This ensures seeing the entire dental arcade. Its small "AAA" battery pack attaches right to the speculum and avoids any long hanging wires.

JOR38X \$126.00/ea



Deluxe Wolf Tooth Elevator

JOR709 with Ergonomic Handle., 22cm L. \$94.00/ea

Double End Elevator 4mm

JOR42Y Stainless Steel Knurled 7 1/4" L handle. \$33.00/ea

EquiVet Dental Pick

JOR939 Stainless Steel, Sharp, 19", 48cm \$52.00/ea

EquiVet Parellel Gingival Elevator

Useful for exploring and elevating between teeth. "T" handle.

JOR939B Stainless Steel, 19", 48cm, Parallel \$54.00/ea

JOR939A Stainless Steel, 19", 48cm, Perpendicular \$55.50/ea



Fetal Extractor

This calf puller provides an entirely new approach to difficult calvings. With one of the handles you can move the two separate hooks alternately, pulling first one limb and then, with the next movement of the handle, the other limb. The most difficult presentation can be zig-zagged out in this manner. The extra-long 65" no-slip shaft disassembles in the middle. Breech is supplied with an adjustable, easy-to-clean chain.

JOR99 \$198.00/ea



Economy Calf Puller

This unit has a design similar to the Hercules calf puller, but costs considerably less.

JOR99E \$120.00/ea

Calf puller carry case

JOR99C \$17.55/ea

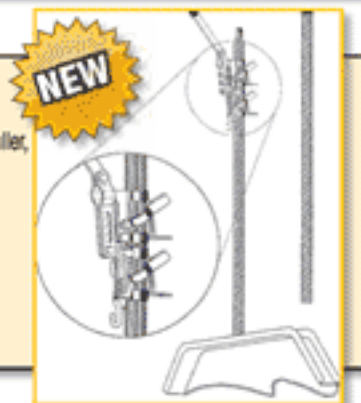

Roaring Burr (French)

For use in equine laryngeal hemiplegia (roaring). French model with hooks.

JOR62S 8 1/2"L. \$18.00/ea



Soft Tissue Protector

Soft Tissue Protector. Fits polishing head of a dental unit.

JOR41ST \$105.00/ea



Diamond Disc Safety Shield

Diamond Disc Safety Shield.

JOR41SS Safety shield only \$105.00/ea



Equine Dental Instruments

A large dental patient like a horse needs oversized equipment. These dental probes, scalers, and explorers are giant sized to 19" with knurled handles. If you do a lot of equine dentistry, you are going to find them very useful.

- JOR440 Explorer or Shepherd's Hook \$36.00/ea
- JOR440A Sickle Shaped Scaler \$36.00/ea
- JOR440B Sickle Shaped Scaler-Heavy \$36.00/ea
- JOR441 Dental Probe Heavy Tip, Calibrated probe is used to measure depth of periodontal pockets \$39.00/ea
- JOR441A Dental Probe Fine Tip, Finer calibrated tip for pulp horns and tooth surface pockets on the occlusal surface of cheek teeth. \$42.00/ea



Dental Scraper

Dental Scaler. #6. Stainless steel.

JOR42J #6. Stainless steel. 6"L. \$4.50/ea



Tooth Cutter

Molar Cutter. The most effective design of a molar cutter has a parallel alignment of the jaws to the tooth surface. This allows the whole tooth to be trimmed, not just at the narrow point of attachment. The jaws of this instrument are a special hardened tempered steel. Knurled handles for a non-slip grip.

JOR708 Angled-56cm \$795.00/ea

JOR707 Straight-56cm \$675.00/ea



Jorvet Tooth Punches

The punch is used for removal of cheek teeth through a trephined hole into the sinus. A knurled handle gives a better grip. A round head with a slight recessed area fits better onto the tooth. Stainless steel.

Tooth Punch-Curved

JOR713 20cm L. \$42.00/ea

Tooth Punch-Straight

JOR712 20cm L. \$39.00/ea



Large Animal Supplies

Hooks, Colostrometers, Balling Guns & Leg Splints



Krey Hook

This double-action OB hook will bite into part of the fetus in the process of doing an embryotomy. Should the instrument slip, the hooks will close automatically and prevent injury.

JOR19 Stainless Steel, 8"L. \$24.00/ea



OB Double Eye Hook

JOR19R Very easy to use. 5 1/2" L. \$15.00/ea



OB Wire Guide

This instrument will bring your wire around any tight or difficult location on the fetus.

JOR20 7"L. \$7.50/ea



Ostertag Blunt Eye Hook

JOR19C Stainless Steel, Hole 5/8" dia. Hook 3/4"L. Total 2"L. \$8.10/ea



Harms OB Hook

Stainless steel. Similar to JOR19c only longer. 4"L.

JOR19HB Blunt End \$12.00/ea
 JOR19HS Sharp \$12.00/ea



Jorvet Equine Colostrometer

The Jorvet Equine Colostrometer utilizes only a small 15ml sample of the mare's colostrum by comparing the specific gravity to distilled water in a plexiglass hydrometer. From the specific gravity obtained, a determination can be made whether or not the foal will be receiving colostrum with adequate IgG concentration. Another benefit is if the colostrum specific gravity is fairly high, up to 250cc can be frozen for a colostrum bank.

JOR281 \$91.00/ea



Hydrometer Cylinder

JOR281D2 \$27.90/ea



Jorvet Bovine Colostrometer

The Jorvet colostrometer measures IgG content in a simple cowside test. The graduated cylinder is filled with a few ounces of Bovine colostrum. The colostrometer is gently inserted and floats to a level indicating the colostrum IgG content. A University of Florida study found only 20 percent of colostrum contained an adequate amount of IgG for good calf health.

JOR349 Plastic \$57.00/ea

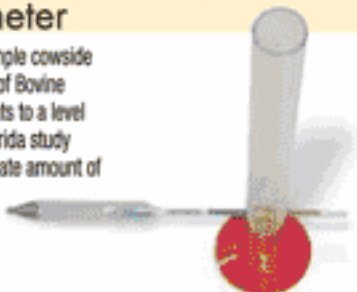

Colostrum-Plus

- Now USDA approved for protection against E-Coli, K-99 antigen
- USDA approved for failure of passive transfer
- Still real colostrum. Not a substitute like cheese whey or blood plasma
- Powder form in foil-lined pouch of 350 gm
- Now with 3-year dating
- Detailed literature upon request
- 12 pk/display box

JOR330EC Dozen \$129.00/dz



Cow Plastic Balling Gun (Red)

Balling Gun, Cow, 7/8" dia. head. Red.
 JOR794 17 1/2"L. \$1.60/ea



Calf Plastic Balling Gun (Blue)

Balling Gun, Calf, 5/8" dia. head.
 JOR793 Blue, 13 1/2"L. \$1.50/ea



Calf Plastic Balling Gun w/grooved head (white)

Balling Gun, Calf, with ribbed 5/8" dia. head. White.
 JOR793A 5/8" dia. head. White. \$1.35/ea



Jorvet LePill Balling Gun

Le Pills are a family of extra large boluses that were developed in cooperation with research conducted at a European veterinary school. Drench and paste use can be dangerous if not properly administered. These boluses are large, but easily dissolved. There is a series of three different formulated boluses for the variety of metabolic conditions encountered in today's high productivity dairy cow. Each tablet is packaged individually in a plastic tube. LePills Balling Gun is especially designed for the large oversize boluses listed above. It has a slightly angled shaft with a wide trigger, and is one of the safest and sturdiest balling guns made.

JOR901B \$68.00/ea



Jorvet Multi-dose Balling Gun

- Simplest design for ease of administration
- High impact PVC tube that resists biting
- Holds enough boluses of any size for any procedure
- Lightweight, only 1.5 lbs.
- Field-tested for over 5 years at some of the country's largest feed yards



JOR185M Holds up to six full-size boluses. 7/8" dia. \$36.00/ea
 JOR185MS Holds up to five calf-size boluses. 5/8" dia. Blue handle. \$22.50/ea

"Bos" Lower Leg Splint

A heavy-duty reinforced rigid PVC splint with closed-cell foam lining. Especially designed for use in larger animals with flexor tendon or lower leg nerve injuries. Placed on the back of the leg and held in place with bandage material (not included).

JOR927 Calf, Green, hindleg, 40cm. \$34.00/ea
 JOR927A Cow, Small, Blue, 47cm. \$45.00/ea
 JOR927B Cow, Large, Orange, 51cm. \$45.00/ea
 JOR927C Cow, XL (Purple) 54cm. \$48.00/ea
 JOR927E Calf, Front leg (Yellow) \$40.00/ea

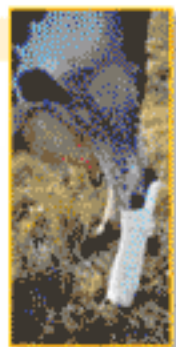

13822 WEST BOULTON BLVD. METTAWA, IL 60045

WWW.SHOPMEDVET.COM

Phone 800-544-7521

353

Fax 800-204-2177

Mastitis, Equine Recovery Hoods & CMT Tests



Jorvet Mastitis Test X-purt

CMT can now be done with a one-hand operation. The 300ml X-purt reagent reservoirs (10 oz) acts as a handle. Milk is put in each paddle chamber (about 3ml or 0.1 oz). A quick squirt of reservoirs inputs equal amounts of test solution into each chamber. Swirling for usual coagulation recognition. Color Chart included. Reservoir bottle capacity will test about 15 cows.



JOR370X Just refill from CMT liquid (JOR370L). \$22.50/ea

Mastitis Indicator **Jorvet**

Jorvet Mastitis Indicators. Color indicator test sheets for mastitis infections. Simple and safe to use. One colored square for each udder quarter.



JOR370M 25-pack \$5.10/pk

Chain Ecrasseur

This is the popular ratchet type ecrasseur by Chassignac. Stainless Steel.

JOR37E German-made. 19". \$410.00/ea



Equine Padded Recovery Hood **Jorvet**

This protective hood is a valuable tool in the prevention of head trauma such as facial nerve paralysis, to any horse undergoing anesthesia. The thick yellow closed-cell foam padding has openings for eyes, ears, and muzzles. The area around the eyes is double padded.

| | | |
|---------|-----------------------|-------------|
| JOR473 | Neonatal foal hood | \$140.00/ea |
| JOR473A | Foal/yearling hood | \$162.00/ea |
| JOR473B | Standard hood | \$185.00/ea |
| JOR473C | Warm blood/draft hood | \$198.00/ea |



Repair Sealant **Jorvet**

JOR473RP Equine Padded Recovery Hood repair sealant, 3 oz. \$19.50/ea



Jorvet Calf Snare

Calf Snare (Cable type). Useful in difficult calvings for pulling a retracted head forward or from preventing the head from turning back during delivery.

JOR99S 26" L \$33.00/ea



Jorvet Detorsion Bar

Used in bovine uterine torsion. Stainless steel.

JOR121 (chain not included) 31 1/2" L. \$93.00/ea



Colorado Style Equine AV

This is a lightweight A.V. in a complete kit with natural latex liners and plastic disposable liner. Also has collection bottle and filter. Comes with complete instruction manual. Many parts will interchange with other CSU or Colorado A.V.'s. Detailed literature upon request.

JOR125AV \$580.00/ea

Latex Collection Liner

JOR125AVD2 Latex Inner Rubber \$37.50/ea

JOR125AVD1 Latex Collection Liner \$40.50/ea

Disposable Plastic Liner

Disposable Plastic Liner. 25/pk.

JOR125AVD3 25 pk. \$34.50/ea



Jorvet CMT Test Kit **Jorvet**

Jorvet offers an introductory kit for mastitis detection and control. The CMT measures somatic cell counts through a special reagent in a four-chambered paddle. Kit includes: Paddle, 0.5-liter empty pump bottle, 1-pint concentrated CMT liquid, and directions with color charts.

JOR370K \$19.80/ea

CMT Paddle

JOR370P \$7.50/ea

CMT Test Liquid

CMT Test Liquid. 1-pint concentrate makes 1 gallon.

JOR370L Concentrate, 1 Gallon \$13.35/ea



Jorvet Squeeze Jet

The Jorvet Squeeze Jet is clear for easier identification of medicines being dispensed. 30ml. Economically packaged 500/pk. or 1000/pk. Tips and caps come 500/bag.

JOR122B clear 1000 pack \$270.00/pk

JOR122A clear, 500 pack \$136.00/pk

JOR122C Empty Carton, holds 12. \$1.20/ea

JOR122CA Clear, Dozen Pack \$8.10/dz



Jorvet Bovine Hobble Strap

These wide heavy-duty nylon straps are the perfect aid in giving support to cows showing the effects of obturator paralysis.

JOR201 \$40.00/ea



Large Animal Supplies

Large Animal Syringes

Henke Roux Revolver

A high-quality precision-made revolver syringe. Of German origin it's known for its accuracy. Dosage is set by turning the dosage setting wheel at the rear of the barrel. For long-lasting dependability, durability and accuracy, buy the "HENKE" Roux.

JOR53H 50cc, adjusts 1, 2, 3, 4 & 5cc.
 JOR53HB Henke Roux, 10cc, adjusts to 1/4, 1/2 & 1cc.

\$57.00
 \$54.00

Henke Roux Revolver Parts

| | | |
|-----------|--|---------|
| JOR53012 | Cap for #11 spring | \$0.60 |
| JOR53018 | Compression spring | \$0.45 |
| JOR53044 | Compression spring | \$2.10 |
| JOR53031B | Disc for piston, 10cc | \$3.00 |
| JOR53031 | Disc for piston, 30cc & 50cc | \$1.50 |
| JOR53020B | Dosage wheel, 10cc | \$6.00 |
| JOR53020 | Dosage wheel, 30cc & 50cc | \$6.90 |
| JOR53036 | Dosage wheel, 30cc minidose | \$9.00 |
| JOR53024B | Front end with luerlock, 10cc | \$5.70 |
| JOR53024 | Front end with luerlock, 30cc & 50cc | \$10.50 |
| JOR53026B | Glass barrel, 10cc | \$3.90 |
| JOR53026A | Glass barrel, 30cc | \$3.30 |
| JOR53013 | Gudgeon bolt | \$1.35 |
| JOR5307 | Handle connecting screw | \$6.00 |
| JOR53055 | Henke dosage repair kit (incl. 2, 11, 42, 43) | \$7.50 |
| JOR53049 | Henke dosage wheel | \$19.50 |
| JOR5302 | Henke dosage wheel screw | \$1.50 |
| JOR53053 | Henke forward handle, complete | \$24.00 |
| JOR53056 | Henke plunger rod kit (incl. 28, 30, 31, 32, 33) | \$27.00 |
| JOR53051 | Henke ratchet clip | \$1.50 |
| JOR53052 | Henke ratchet screw | \$1.80 |
| JOR53045 | Henke rear handle, complete | \$45.00 |
| JOR53054 | Henke Roux repair kit | \$21.00 |
| JOR53026 | Glass barrel, 50cc | \$3.90 |
| JOR53042 | Henke set screw | \$3.35 |

| | | |
|-----------|------------------------------------|---------|
| JOR53043 | Henke steel ball, 4 mm | \$1.80 |
| JOR53028B | Inner rod, 10cc | \$6.00 |
| JOR53028 | Inner rod, 50cc | \$6.90 |
| JOR53028A | Inner rod, 30cc | \$6.90 |
| JOR53028B | Inner rod, 10cc | \$6.00 |
| JOR53033 | Knurled knob | \$6.00 |
| JOR53028A | Inner rod, 30cc | \$6.90 |
| JOR53028B | Inner rod, 10cc | \$6.00 |
| JOR53027 | Plastic barrel with luerlock, 50cc | \$14.40 |
| JOR53027A | Metal frame, 30cc | \$14.40 |
| JOR53027B | Metal frame, 10cc | \$14.40 |
| JOR53037 | Outer rod, 30cc minidose | \$4.50 |
| JOR53032 | Outer rod, 50cc | \$9.60 |
| JOR53032A | Outer rod, 30cc | \$9.60 |
| JOR53032B | Outer rod, 10cc | \$9.60 |
| JOR530260 | Plastic barrel, 30cc | \$2.40 |
| JOR53026P | Plastic barrel, 50cc | \$3.90 |
| JOR53026R | Plastic barrel with luerlock, 50cc | \$10.50 |
| JOR53011 | Ratchet spring | \$0.90 |
| JOR53014 | Ratchet tip | \$5.40 |
| JOR5301B | Rear grip, 10cc | \$33.00 |
| JOR5301 | Rear grip, 30cc & 50cc | \$36.00 |
| JOR53030B | Rubber piston, 10cc | \$1.80 |
| JOR53030 | Rubber piston, 30cc & 50cc | \$1.80 |
| JOR53035 | Spring for handles | \$3.90 |
| JOR53025B | Washer set, 10cc | \$3.30 |
| JOR53025 | Washer set, 30cc & 50cc | \$3.30 |

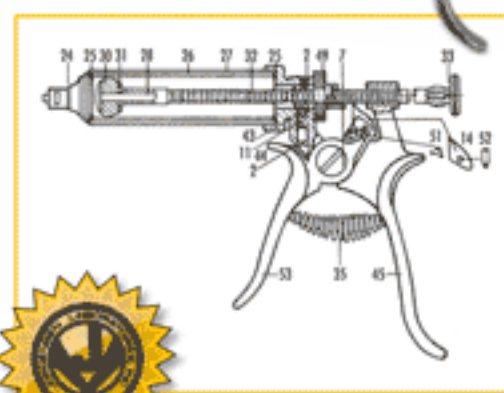

Ferromatic Automatic Syringe

Unique design has dosage adjustments from .5ml to 5.0ml. Fits bottle tops from 30ml-120ml. Features:

- One-piece front end with luer lock
- A valve accessory allowing user to adapt the syringe for use with a collapsible bottle (part #14c optional)
- Tubing and attachment to allow draw offs from bottles (optional)
- New plastic valve system to prevent valve "swelling"

JOR53F91 5cc, M91 \$113.00

Ferromatic Automatic Syringe Parts

| | | |
|-------------|-------------------------|---------|
| JOR53FD191 | Barrel Frame, M91 | \$27.00 |
| JOR53FD21 | Closing cap | \$2.70 |
| JOR53FD11 | Compression spring | \$3.90 |
| JOR53FD1191 | Compression spring, M91 | \$3.00 |
| JOR53FD6 | Crutch handle | \$3.00 |
| JOR53FD8 | Dosing device | \$4.50 |
| JOR53FD891 | Dosing device M91 | \$6.00 |
| JOR53FD8M | Dosing device, M86 | \$4.50 |
| JOR53FD10M | End washer M86 & M91 | \$1.80 |
| JOR53FD9 | Fixing nut | \$2.25 |
| JOR53FD991 | Fixing nut, M91 | \$2.25 |
| JOR53FD1M | Frame, M86 | \$24.00 |
| JOR53FD2291 | Front piece, M91 | \$33.00 |
| JOR53FD691 | Front screw | \$10.50 |
| JOR53FD2M | Sec. M86, M91 | \$6.00 |
| JOR53FD7 | Guiding cap | \$1.80 |
| JOR53FD791 | Guiding cap M91 | \$6.00 |
| JOR53FD7M | Guiding cap, M86 | \$1.80 |
| JOR53FD23 | Luerlock adaptor | \$4.50 |
| JOR53FD4 | O-Ring Washer piston | \$1.80 |
| JOR53FD3 | Piston | \$3.30 |

| | | |
|--------------|--|---------|
| JOR53FD6M | Piston rod and handle, M86 | \$9.00 |
| JOR53FD691 | Piston rod and handle, M91 | \$10.50 |
| JOR53FD27 | Piston rod assembly, 3, 4, 5, 6 | \$12.00 |
| JOR53FD391 | Piston, M91 | \$4.50 |
| JOR53FD2891 | Repair kit (4, 10M, 2 of 1291, 1391, 1691) | \$30.00 |
| JOR53FD28 | Repair kit (4, 10, 3 of 12, 13, 16, 17, 18, 20, 25) | \$21.60 |
| JOR53FD28M | Repair kit (4, 10M, 3 of 12, 13, 16, 17, 18, 20, 25) | \$21.60 |
| JOR53FD12 | Rubber valve* | \$3.00 |
| JOR53FD19M | Screw cap - 07 | \$9.00 |
| JOR53FD19 | Screw cap | \$4.50 |
| JOR53FD3191 | Tubing | \$6.00 |
| JOR53FD3291 | Attachment | \$6.00 |
| JOR53FD14C | Valve head, M91, collapsible bottle | \$36.00 |
| JOR53FD14G | Valve head, M91, non-collapsible bottle | \$30.00 |
| JOR53FD15 | Valve head screw* | \$3.00 |
| JOR53FD14V91 | Valve screw | \$6.00 |
| JOR53FD4M | Washer piston | \$1.80 |

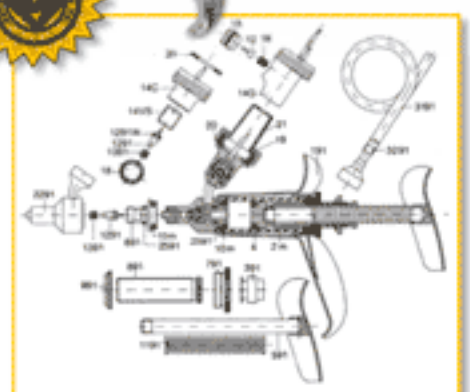



Hauptner Syringe

Famously accurate and correct dosing.

| | |
|--------|---|
| JOR31A | 10cc, adjusts to 1/4, 1/2, 3/4, and 1cc doses. |
| JOR31B | 30cc, adjusts to 1, 2, 3, 4, and 5cc doses. |
| JOR31C | 50cc, adjusts to 1, 2, 3, 4, and 5cc doses. |
| JOR31E | 25cc, adjusts to 1/2, 1, 1 1/2, 2 and 2 1/2. Excellent for injecting Iomecol® |

| |
|----------|
| \$108.00 |
| \$83.00 |
| \$88.35 |
| \$112.50 |

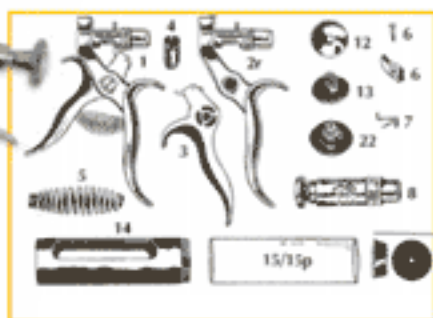

Hauptner Syringe Parts

| | | |
|------------|--|---------|
| JOR31TBM | 2cc Glass barrel | \$30.00 |
| JOR31D1 | Complete grip, 30cc & 50cc | \$85.00 |
| JOR31D1E | Complete grip, 25cc | \$60.00 |
| JOR31D2 | Thumb grip less regulator, 30cc & 50cc | \$19.50 |
| JOR31D22 | Luerlock with endplate, 30cc & 50cc | \$6.60 |
| JOR31D15A | Glass barrel, 10cc | \$3.90 |
| JOR31D15E | Glass barrel, 25cc | \$3.90 |
| JOR31D15B | Glass barrel, 30cc | \$3.90 |
| JOR31D15C | Glass barrel, 50cc | \$3.90 |
| JOR31D23 | HAUPTNER repair kit (incl. 6, 7, 15c, 18m) | \$13.80 |
| JOR31D10A | Inner rod, 10cc | \$8.40 |
| JOR31D10E | Inner rod, 25cc Complete grip, 30cc & 50cc | \$7.50 |
| JOR31D10B | Inner rod, 30cc | \$8.70 |
| JOR31D10C | Inner rod, 50cc | \$7.50 |
| JOR31D22A | Luerlock with endplate, 10cc | \$9.00 |
| JOR31D22DE | Luerlock with endplate, 25cc | \$13.50 |
| JOR31D14A | Metal cover, 10cc | \$15.00 |
| JOR31D14E | Metal cover, 25cc | \$21.00 |
| JOR31D14B | Metal cover, 30cc | \$15.00 |
| JOR31D14C | Metal cover, 50cc | \$15.60 |
| JOR31D11A | Outer rod, 10cc | \$9.00 |

| | | |
|------------|---------------------------------|----------|
| JOR31D11E | Outer rod, 25cc | \$9.00 |
| JOR31D11B | Outer rod, 30cc | \$9.30 |
| JOR31D11C | Outer rod, 50cc | \$8.40 |
| JOR31TBM | Perpendo TB syringe, 2cc | \$120.00 |
| | Piston rubber (only 25cc) | \$1.50 |
| JOR31D15PB | Plastic barrel, 30cc | \$2.40 |
| JOR31D15PC | Plastic barrel, 50cc | \$3.90 |
| JOR31D12A | Plate for plunger, 10cc | \$4.50 |
| JOR31D12E | Plate for plunger, 25cc | \$4.50 |
| JOR31D12 | Plate for plunger, 30cc & 50cc | \$2.70 |
| JOR31H | Revolver Holder | \$0.00 |
| JOR31D1A | Complete grip, 10cc | \$60.00 |
| JOR31D1E | Washer pack set, 30cc & 50cc | \$4.20 |
| JOR31D16E | Washer pack set, 25cc | \$4.50 |
| JOR31D2RA | Thumb grip with regulator, 10cc | \$39.00 |
| JOR31D2RE | Thumb grip with regulator, 25cc | \$42.00 |
| JOR31D3 | Grip with ratchet | \$27.00 |
| JOR31D4 | Lock screw | \$1.95 |
| JOR31D8A | Dosage regulator, 10cc | \$24.00 |
| JOR31D9A | Complete plunger, 10cc | \$22.80 |
| JOR31D9B | Complete plunger, 30cc | \$24.00 |
| JOR31D9C | Complete plunger, 50cc | \$22.50 |

| | | |
|-----------|--|----------|
| JOR31D9E | Complete plunger, 25cc | \$24.00 |
| JOR31D5 | Spring for grips | \$1.20 |
| JOR31TBC | TB caliper | \$90.00 |
| JOR31TBN | TB needle | \$12.60 |
| JOR31D13A | Tension screw, 10cc | \$3.90 |
| JOR31D13 | Tension screw, 25cc, 30cc, 50cc | \$3.90 |
| JOR31D2A | Thumb grip less regulator, 10cc | \$28.00 |
| JOR31D2 | Thumb grip less regulator, 30cc & 50cc | \$19.50 |
| JOR31D16A | Washer pack set, 10cc | \$4.50 |
| JOR31D16E | Washer pack set, 25cc | \$4.50 |
| JOR31D16 | Washer pack set, 30cc & 50cc | \$4.20 |
| JOR31D16M | Washer pack set, modified, 30cc & 50cc | \$4.50 |
| JOR31TBM | Perpendo TB syringe, 2cc | \$120.00 |
| JOR31TBN | TB needle | \$12.60 |

Vetamatic Syringe, 5cc

A handy, sturdy automatic multidose syringe. Plastic valve and washer reduces swelling problems.

NOTE: Spare Parts Ordering: Parts 13, 1494 and 1694 as shown on parts diagram are not available individually. They can be purchased only as a repair kit: J-53vd 2894

| | | |
|----------|----------------|------------|
| JOR53V94 | .5ml to 5.0ml. | \$84.00/ea |
|----------|----------------|------------|

Vetamatic Syringe Parts

| | | |
|-------------|----------------------------|---------|
| JOR53V94 | .5ml to 5.0ml. | \$84.00 |
| JOR53VD794 | Compression spring | \$2.40 |
| JOR53VD9M | Dose fixing nut, M86 | \$4.50 |
| JOR53VD9M | Dosing screw and tube, M86 | \$7.50 |
| JOR53VD894 | Dosing sheath | \$6.00 |
| JOR53VD24A | Filler needle, 4 3/4" | \$9.00 |
| JOR53VD24B | Filler needle, 7 1/2" | \$18.00 |
| JOR53VD24C | Filler needle, 8 1/2" | \$13.50 |
| JOR53VD994 | Fixing nut | \$2.40 |
| JOR53VD1794 | Front end | \$18.00 |
| JOR53VD17M | Front end, M86 | \$18.00 |
| JOR53VD294 | Front screw | \$5.10 |
| JOR53VD4M | Glass barrel, M86 & M91 | \$6.00 |
| JOR53VD1M | Metal frame | \$27.00 |
| JOR53VD1294 | Piston | \$4.50 |

| | | |
|-------------|--|---------|
| JOR53VD594 | Piston rod | \$28.00 |
| JOR53VD2894 | Repair kit (2 each of 13, 1494, 1694) | \$21.00 |
| JOR53VD28 | Repair kit (3, 11, 13, 2 of 14, 15, 16, 18) | \$18.00 |
| JOR53VD28M | Repair kit M86 (3m, 13, 2 of 14, 15, 16, 18) | \$19.50 |
| JOR53VD1094 | Screw cap | \$6.00 |
| JOR53VD10M | Screw cap, M86 | \$3.90 |
| JOR53VD26 | Screw cap, M91 | \$9.00 |
| JOR53VD22 | Sinker | \$2.25 |
| JOR53VD6 | Spring sleeve | \$2.10 |
| JOR53VD7M | Spring, M86 | \$3.90 |
| JOR53VD23 | Tabing | \$6.00 |
| JOR53VD1494 | Valve and washer | \$6.00 |

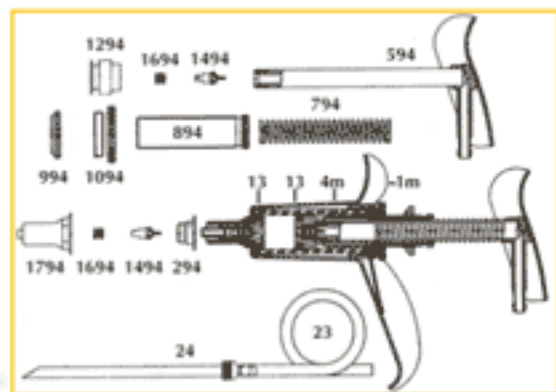

Drenches

Henke Drench-Matic 23cc

An automatic syringe for administration of solutions and suspensions. Its transparent plastic graduated barrel allows instant check of dosage setting. An "anti-block" valve system prevents blocking, so that smooth continuous operation is guaranteed. Easily adjusts from 0-23ml in 2.5ml increments. Special hardened enamel painting provides both aesthetics and durability.

JOR128M Drench-Matic Syringe complete with container. \$160.00

Henke Drench-Matic Parts

| | | |
|------------|---|-------------|
| JOR128M | Drench-Matic Syringe complete with container. | \$160.00/ea |
| JOR128MD1 | Barrel frame | \$36.00/ea |
| JOR128MD2P | Plastic barrel, 23cc | \$9.75/ea |
| JOR128MD3 | Front end piece | \$9.00/ea |
| JOR128MD4 | Round washer | \$3.00/ea |
| JOR128MD5 | Lock nut for #3 | \$3.00/ea |
| JOR128MD6 | Valve and washer | \$6.90/ea |
| JOR128MD7 | Valve spring | \$4.50/ea |
| JOR128MD8 | Nozzle and washer | \$16.50/ea |
| JOR128MD8W | Nozzle washer only | \$1.80/ea |
| JOR128MD9 | Nozzle nut | \$7.50/ea |
| JOR128MD10 | Piston rod complete (6,7,11,12,13,14) | \$33.00/ea |
| JOR128MD11 | Piston rod | \$15.00/ea |
| JOR128MD12 | Valve screw | \$4.50/ea |
| JOR128MD13 | Piston washer | \$4.50/ea |
| JOR128MD14 | Nylon piston | \$15.00/ea |
| JOR128MD15 | Front handle | \$33.00/ea |
| JOR128MD16 | Spring pin | \$0.45/ea |

| | | |
|-------------|----------------------|------------|
| JOR128MD17 | Rear handle | \$21.00/ea |
| JOR128MD18 | Plastic insert (2) | \$1.80/pr |
| JOR128MD19 | Handle screw | \$2.25/ea |
| JOR128MD20 | Dosing screw | \$4.50/ea |
| JOR128MD21 | Dosing screw nut | \$7.50/ea |
| JOR128MD22 | Handle spring | \$6.00/ea |
| JOR128MD23 | Lower spring screw | \$4.50/ea |
| JOR128MD24 | Disc | \$1.80/ea |
| JOR128MD25 | Knurled knob | \$7.50/ea |
| JOR128MD26 | Frame screw | \$0.90/ea |
| JOR128MD28 | Feeding tube | \$10.50/ea |
| JOR128MD30 | Injection attachment | \$15.00/ea |
| JOR128MD30W | Washer for #30 | \$2.10/ea |
| JOR128MD31 | Container complete | \$36.00/ea |
| JOR128MD32 | Cap & nozzle | \$3.90/ea |
| JOR128MD33 | Straps | \$7.50/ea |

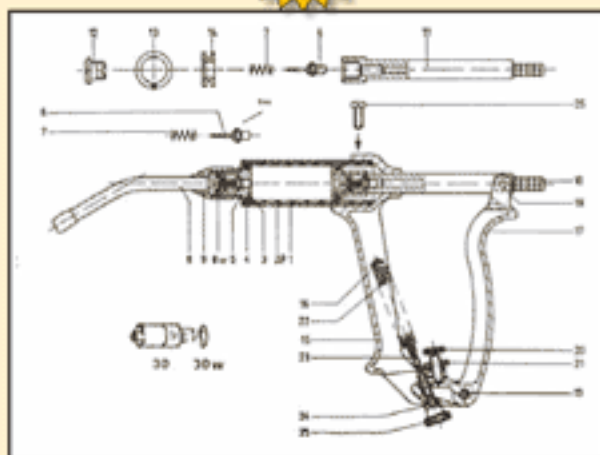

Vaxi-Drench 15 Injector/Drenche, 15cc

Designed for administration of all drenches or injectable solutions within its dose range. Comes complete with 2.9 liter vinyl reservoir, strapping, funnel and necessary tubing. Adjust from 2.5cc to 15cc in 1/2cc increments.

JOR126 Injector/Drencher \$274.00/ea

Vetamatic Syringe Parts

| | | |
|-----------|-----------------------------|---------|
| JOR126D19 | Adaptor | \$15.00 |
| JOR126D31 | Cap & nozzle | \$16.50 |
| JOR126D29 | Container complete | \$54.00 |
| JOR126D18 | Cylinder | \$24.00 |
| JOR126D15 | Cylinder cage | \$18.00 |
| JOR126D17 | Cylinder seal ring | \$3.90 |
| JOR126D13 | Lock nut | \$7.50 |
| JOR126D23 | Dosage adjuster screw & nut | \$7.50 |
| JOR126D30 | Feed tube & clamps | \$9.00 |
| JOR126D22 | Handle | \$30.00 |
| JOR126D29 | Container complete | \$54.00 |
| JOR126D10 | Injection attachment | \$24.00 |
| JOR126D20 | Lever | \$48.00 |
| JOR126D21 | Lever pad, set of 2 | \$7.00 |
| JOR126D27 | Lever screw | \$12.00 |
| JOR126D11 | Needle nut | \$9.00 |

| | | |
|-----------|----------------------------------|---------|
| JOR126D12 | Nozzle | \$15.00 |
| JOR126D16 | Nozzle nut | \$9.00 |
| JOR126D9 | Nozzle seal ring | \$2.70 |
| JOR126D1 | Piston cap | \$7.80 |
| JOR126D5 | Piston spacer | \$7.50 |
| JOR126D4 | Piston washer, (2) | \$6.75 |
| JOR126D6 | Push rod | \$38.00 |
| JOR126D32 | Repair kit, parts 2,3,4,7,8,9,17 | \$22.50 |
| JOR126D24 | Return spring | \$6.00 |
| JOR126D25 | Return spring adjuster | \$12.00 |
| JOR126D26 | Return spring adjuster screw | \$9.00 |
| JOR126D3 | Valve & seal ring | \$8.40 |
| JOR126D7 | Valve & seal ring | \$8.40 |
| JOR126D2 | Valve spring | \$2.10 |
| JOR126D8 | Valve spring | \$2.10 |
| JOR126D28 | Handle clamp screw | \$2.70 |

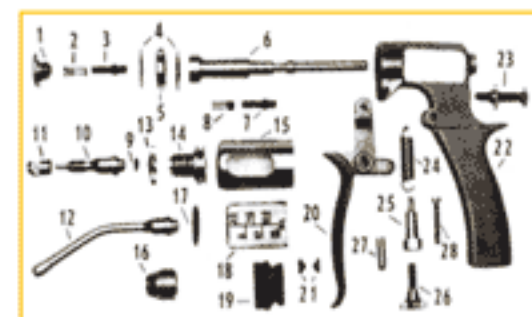

Emasculators

Serra Emasculator

This instrument draws the cord concentrically into the jaws, thus preventing slipping of the cord. Hemorrhage is reduced to a minimum. Ratchet holds emasculator lock, as in JOR37.

| | | |
|---------|-----------------------|-------------|
| JOR37S | Hauptner, 14", Chrome | \$675.00/ea |
| JOR37SS | Stainless Steel | \$510.00/ea |

White's Modified Emasculator

White's Modified Emasculator with extra crushing area.

| | | |
|---------|----------------------|-------------|
| JOR36W | Stainless steel, 12" | \$202.00/ea |
| JOR36WS | Stainless steel, 8" | \$66.00/ea |

Standard Emasculator

Hausman Standard Emasculator. 

| | | |
|--------|----------------------|-------------|
| JOR36P | Stainless steel, 12" | \$116.00/ea |
|--------|----------------------|-------------|

Small Emasculator

Small Emasculator. Stainless steel, 7 1/2". 

| | | |
|--------|--------|------------|
| JOR36S | 7 1/2" | \$81.00/ea |
|--------|--------|------------|

Serra Modified Emasculator

Hauptner's finest emasculator, excellent for equine work. For one-hand use. A concave cutting plate draws the cord concentrically into the jaws of the castrator, whereby slipping of the cord is avoided. The cord and surrounding strands are centrally gripped, pressed together and cut through. Reduces tissue slippage and post-op hemorrhage.

| | | |
|----------|-----------------------|-------------|
| JOR37SA | Hauptner, 14", Chrome | \$745.00/ea |
| JOR37SAS | Stainless Steel, 14" | \$540.00/ea |

Hauptner Reimer Emasculator

| | | | |
|--------|--------|-------------|---|
| JOR37H | Chrome | \$890.00/ea |  |
|--------|--------|-------------|---|



Jorvet Emasculator Instrument Aid

| | |
|---------|-------------|
| JOR37CA | \$160.00/ea |
|---------|-------------|



Equivet Cervical Forcep

To grasp equine cervix during embryo transfer. 54 cm L 30mm jaw. (not pictured)

| | | |
|---------|-------------------|-------------|
| JOR15CE | 54 cm L 30mm jaw. | \$325.00/ea |
|---------|-------------------|-------------|

Emasculatome

With cord stop for bloodless castration. Includes wrench on all models.

| | | |
|----------|-----|-------------|
| JOR37EMC | 14" | \$138.00/ea |
| JOR37EMB | 12" | \$134.00/ea |
| JOR37EMD | 16" | \$144.00/ea |
| JOR37EME | 19" | \$150.00/ea |
| JOR37EMA | 9" | \$117.50/ea |



Newberry Castrating Knife

Stainless Steel. Will split the scrotum for easier removal of testicles.

| | | |
|--------|------------|------------|
| JOR37N | 10 1/2" L. | \$30.00/ea |
|--------|------------|------------|





Newberry Blade

| | |
|---------|-----------|
| JOR37NB | \$3.00/ea |
|---------|-----------|





Knee Brace for Emasculatome

| | | |
|--------|---|------------|
| JOR37K | Emasculatome Knee Brace for large models. | \$15.00/ea |
|--------|---|------------|





Elastrator (replaces JOR36)

Heavy-Duty Elastrator for applying latex bands used in tail docks and castration. Metal

| | | |
|---------|------------------|------------|
| JOR36HD | 22cm (8 1/4") L. | \$18.00/ea |
|---------|------------------|------------|



Latex Elastrator Bands

High-quality latex bands.

| | | |
|--------|----------|-----------|
| JOR36B | 100 pack | \$2.10/bg |
|--------|----------|-----------|



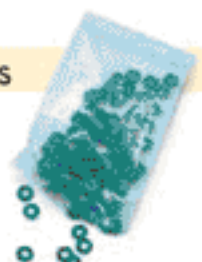

Jorvet Even Crush Emasculator

Extra crushing area moves as crushing takes place.

| | | |
|--------|----------------------|-------------|
| JOR36E | Stainless steel, 12" | \$202.00/ea |
|--------|----------------------|-------------|





Jorvet Equine Condom

Heavy latex rubber.

| | | |
|--------|------|------------|
| JOR123 | Each | \$10.05/ea |
|--------|------|------------|



Sinus Trephine & Wolftooth Dental



Pig Tooth Nipper

| | | |
|---------|---------------------------|------------|
| JOR42H | Nickel-plated. 5 1/2"L. | \$15.00/ea |
| JOR42HS | Stainless steel. 5 1/2"L. | \$8.80/ea |

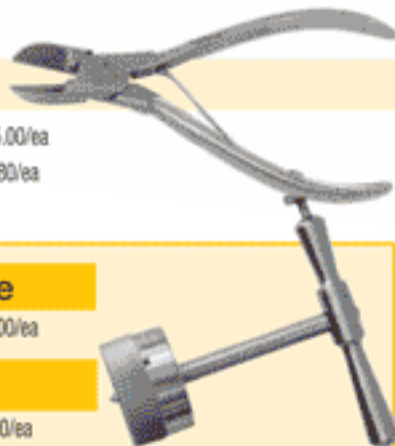

Equine Sinus Trephine

| | | |
|---------|----|-------------|
| JOR161E | 2" | \$145.00/ea |
|---------|----|-------------|

Horsley's Trephine

| | | |
|---------|----------------|------------|
| JOR161A | Complete, 1/2" | \$48.00/ea |
| JOR161B | Complete, 3/4" | \$48.00/ea |
| JOR161C | Complete, 1" | \$48.00/ea |

Trephine Head Only

| | | |
|--------------|------|-------------|
| Not Pictured | | |
| JOR706THL | 25mm | \$120.00/ea |
| JOR706THM | 22mm | \$120.00/ea |
| JOR706THS | 19mm | \$120.00/ea |

Trephine Handle Only

| | |
|-----------|------------|
| JOR706THH | \$76.00/ea |
|-----------|------------|

Trephine Set

| | | |
|--------------|----------------------|-------------|
| Not Pictured | | |
| JOR706TS | (handle and 3 heads) | \$395.00/ea |

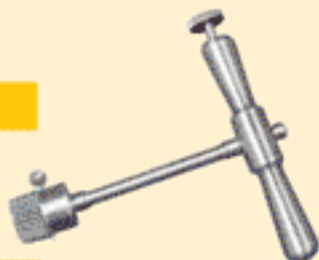

Percussion Chisel



Dental Chisel with sliding bar or percussion handle. The working end has a notched "V". It works great for removing upper premolar hooks and lower rear molar hooks. Stainless steel.

| | | |
|--------|------------------|-------------|
| JOR701 | 23" L, collapsed | \$168.00/ea |
|--------|------------------|-------------|

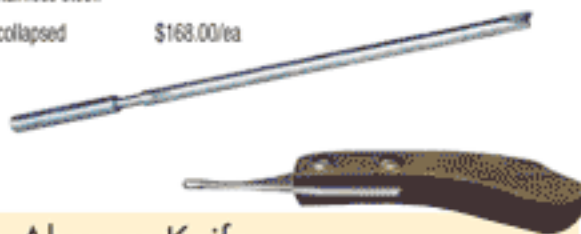

Small Loop Abscess Knife

Designed to curette out the smallest of abscess with this very sharp, but small loop.

| | | |
|--------|---|------------|
| JOR34L | Left handed only, ergonomic shaped wood handle. | \$45.00/ea |
|--------|---|------------|

Short/Narrow Jaw Molar Extractor Forceps

Serrated short jaw creates good purchase on cheek and pre-molar retained deciduous teeth. These forceps have a shorter or smaller jaw surface than compared to the standard JOR43 Molar Forceps for wide jaw surface.

| | | |
|--------|------------|-------------|
| JOR43B | 21" length | \$180.00/ea |
|--------|------------|-------------|



Wolftooth Extractor Set

Includes four different sized interchangeable heads that fit completely around the tooth reducing chance of slipping and injuring the soft tissue or gingiva. Includes elevator blade for loosening tooth. Also can be used to remove tooth fragments.

| | | |
|--------|----------------------------------|-------------|
| JOR711 | Comes in convenient canvas case. | \$290.00/ea |
|--------|----------------------------------|-------------|



Wolftooth Extractor Forcep

Wolftooth Extractor Forceps. Stainless steel.

| | | |
|--------|-----------|------------|
| JOR43H | 11 1/2"L. | \$45.00/ea |
|--------|-----------|------------|



Wolftooth Elevator

The length of the blade can be shortened or lengthened as desired by loosening the set screw with the wrench.

| | |
|--------|------------|
| JOR43W | \$22.50/ea |
|--------|------------|



Wolftooth Elevator Set

This attractive professional looking kit has six different instruments to help elevate any size of wolf tooth.

- Different elevators:
- 5mm sharp concave point with rounded backside, 6" length
- 5mm sharp concave point with a curved head, 6" length
- Large 9mm concave sharp head, 6" length
- Longer, heavier handle with a 5mm slightly curved deep concave head, 9" length
- Longer, heavier handle 5mm deep concave head, 9" length
- 9mm concave curved replaceable head on ergonomic curved heavy handle, 8" length

All in handy, padded black zipper pouch with red velvet lining

| | |
|--------|------------|
| JOR43Y | \$99.00/ea |
|--------|------------|

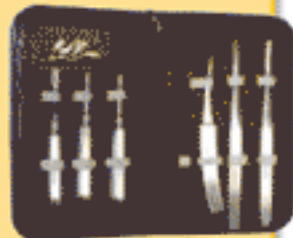

Wolftooth Elevator Set

Two different head sizes allow this instrument to "cap" the wolf tooth. By rotating clockwise and counter clockwise, the tooth can be separated from the alveolus. Angulated head is useful on teeth that are set well back.

| | | |
|---------|-------------|---|
| JOR43AB | \$110.00/ea |  |
|---------|-------------|---|



Drinkwater Mouth Gag

Drinkwater Mouth Gag for cattle. Holds onto inter-dental space. Self-retaining.

| | | |
|--------|-----------------|------------|
| JOR380 | (right or left) | \$21.00/ea |
|--------|-----------------|------------|





Equine Full Mouth Speculum **Jorvet**

Latest design of full-mouth Equine speculum. Made of lightweight aircraft high-grade aluminum, weighs only 31/2 lbs. Other improvements are larger knob for easily adjusting ratchet. A locking screw will hold ratchet position

JOR38ZX light weight \$1,550.00/ea



Equivet Dental Halter **Jorvet**

Especially useful for prolonged procedures. This special halter has a large, sturdy nose band made of a leather-covered round metal circle.

JOR914 A small ring is at each 90° for attachment of a support or restraint rope. \$236.00/ea



Weingart's Mouth Speculum

A full-mouth speculum for bovine use. The gag is easily inserted and has a self-locking mechanism to allow full visualization of the bovine oral cavity. **Jorvet**

JOR38W \$250.00/ea



Twitch **Jorvet**

Kendall model. Complete with tie rope.

JOR44 Stainless steel, 13". \$13.50/ea



Schoupe Wedge **Jorvet**

Reduces the danger of slipping with this instrument since it is held in place by the equine cheek area. Inserted without difficulty. It permits greater freedom in treating any part of the oral cavity.

JOR38S Tie rope included. \$48.00/ea



Meier Dental Wedge

Helps facilitate examination of the mouth and floating of teeth.

JOR38M \$51.00/ea **Jorvet**

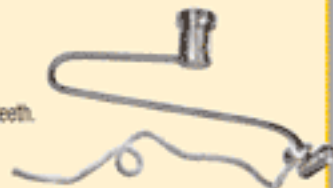

Bayer Mouth Wedge

This oral speculum is very handy when examining the oral cavity or doing dental work in equine. **Jorvet**

JOR38 Stainless Steel \$92.00/ea



Meister Equine Mouth Gag & Light

"The ultimate speculum for doing the right job." Originally developed, designed, and patented by Dr. Jack Meister. This speculum is the gold standard for doing proper and thorough equine dentistry. A full-mouth speculum. Stainless steel. Includes Biothane straps. Improvements include ridge along ratchet to help avoid side slippage. Recessed areas in upper dental plate for placement of light source (JOR38X) included. Caution should be used with all full-mouth equine speculums. Be sure set-screw is set properly to prevent slippage.

JOR38ZM Modified \$1,490.00/ea



McPherson Mouth Gag

Full-mouth gag for equine dental work. Comes complete with leather straps and tooth plates for upper and lower incisors.

JOR38MPS Stainless Steel \$356.00/ea

Pony Size Mouth Speculum

JOR38MPSP Pony Size, Stainless Steel \$350.00/ea



Equivet Mouth Wedge

JOR38X Stainless steel. \$88.00/ea

Jorvet

Replacement Rubber Block

This design employs molded rubber blocks. These give an atraumatic cushion plus more comfort for the horse. The rubber block is simply replaced when worn.

JOR38KB \$24.00/ea



Equivet Pony Size Mouth Wedge

This design employs molded rubber blocks. These give an atraumatic cushion plus more comfort for the horse. The rubber block is simply replaced when worn.

JOR38KP Stainless steel \$86.00/ea

Jorvet

Spare Rubber Block

This design employs molded rubber blocks. These give an atraumatic cushion plus more comfort for the horse. The rubber block is simply replaced when worn.

JOR38KPB for Pony mouth wedge \$21.00/ea



EquiVet Cheek Retractor

Pulls the cheek gently away from the cheek teeth so occlusion can be evaluated on a closed mouth. Also useful for providing more room when power float equipment is being used. By turning retractor around, you get two sizes.

JOR938 Stainless Steel \$52.00/ea





Jorvet Equine Hoof Positioning Blocks

These simple blocks elevate the hoof off the ground for better x-rays of the lower limb including evaluation of any P3 rotation.

- Lightweight, shatterproof, polycarbonate and wood construction
- Non-slip surface covered with special 3M material Radiopaque. Cross hairs provide geometric position indicator on the exposed film.
- Dual cassette holding slots for lateral and AP views
- Holds all sizes of x-ray cassettes
- Grid ready — has room in cassette slot to hold a grid if deemed necessary
- Attractive storage bag 12" L x 8" W x 10" H

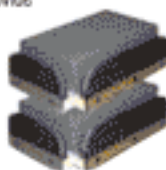

JOR492X Block size is: 11" L x 7 1/4" W x 3 1/2" H \$180.00/pr



Eyesaver™ Eye Patch

Jorvet EyeSaver™, the ultimate in eye care, features the exclusive Equine Eye Patch. EyeSaver's Eye Patch effectively closes the horse's eye for maximum pain relief while allowing for constant monitoring of the injury or problem. EyeSaver affords the eye the most complete rest possible, eliminating the need for surgical closure. Don't let minor injuries become major problems—order your EyeSavers now. You'll be glad you did. EyeSaver Kit contains:

- EyeSaver hood
- 3 tear pads
- 3 snap-on rings
- 25 gauze pads

| | | |
|-------------|-----------------------------|-------------|
| JOR477L | Standard, Left | \$78.00/ea |
| JOR477R | Standard, Right | \$78.00/ea |
| JOR478L | Left, X-Large | \$78.00/ea |
| JOR478R | Right, X-Large | \$78.00/ea |
| JOR479L | Foal/Weanling, Left | \$78.00/ea |
| JOR479R | Foal/Weanling, Right | \$78.00/ea |
| JOR478XL | XX-Large, Left | \$80.00/ea |
| JOR478XR | Right, XX-Large | \$80.00/ea |
| JOR479DS | Double Sided, Foal/Weanling | \$106.00/ea |
| JOR477DS | Double-Sided, Standard | \$106.00/ea |
| JOR478DS | Double-Sided, X large | \$106.00/ea |
| JOR478X LDS | Double Sided, XX- Large | \$124.00/ea |

Replacement Eyesaver™ Eye Patch

| | | |
|----------|---------------------------------|------------|
| JOR479D | Tear Duct Pad Set Replacement | \$38.00/ea |
| JOR479DF | Ring Set for Foal Size Eyesaver | \$38.00/ea |

Equine "Army Surplus" Brown Leg Wrap.

This popular wrap was originally an army surplus product. The thick pad is brown on one side, white on the other. It is combined with two rolls of 6" brown cling gauze for a complete wrap. 18" x 22" brown gauze pad.

JOR3490 18x22 pad w/ 6" brown gauze (2) \$6.10/ea



Jorvet Equine Haler

A reusable inhalation "spacer." The one-way valve allows the medication to be passed only when the horse inhales. It can be easily cleaned for continued use. The inhalation device has been developed specifically for accurate administration of pharmaceuticals to horses with inflammatory respiratory diseases including chronic obstructive pulmonary disease (i.e., recurrent airway obstruction, or RAO). The Equine Haler provides a convenient method of administering all available types of metered dose inhalers (MDI) to horses. The MDI delivers the medicine at a suitable particle size, (<5 microns) for direct distribution to the small airways. Developed in Denmark and tested at the Centre for Equine Studies, Animal Health Trust, Newmarket, UK.



JOR344 One treatment takes 1-2 minutes. \$184.00/ea



Nequilizer Equine Nebulizer Kit

- Portable breath regulated nebulizer. Effective nebulization is all about:
- High lung deposition
- Ease of use
- Patient acceptance
- Minimizing wastage Based on the ultrasonic technique the Nequilizer is:
- Portable - handheld, rechargeable
- Intelligent - only operates when horse breathes
- Rapid - delivers 5 ml of medication in 15-20 breaths or 4- 5 minutes
- Direct - no tubing or large mask for aerosol to be deposited on
- Acceptable - low-resistance, quiet operation will not alarm horses
- Optimized - small median particle size (2.8um) with 90% of particles <5.5um
- Versatile - can be used with any water based solution
- User-friendly - light weight, ergonomic handle
- Visible - clear plastic chamber with indicator to confirm correct operation



JOR344N Battery Powered \$995.00/ea



Medication Cups

JOR344NC 5cc, 50pk \$39.00/pk

Jorvet Equine Incisor Gag

There are situations where it is only necessary to examine the incisors. This simple gag is placed in the mouth the same way as a bit in the interdental space. It creates easy access to the incisors. Heavy-duty, but comfortable rubber held in place by adjustable nylon rope.

JOR386 Heavy-duty \$34.90/ea



Equine Leg Wrap & Technovit Treatment



Jorvet Equine Leg Wrap

Jorvet

Made of soft, quality bulk cotton which is covered on both sides with a permeable thin layer of nonwoven material. The wrap acts much like a diaper in that the wound exudate is lifted and absorbed into the thick middle cotton layer. A dark mark mid-line runs full length to give proper orientation during application. A wide variety of materials and sizes are now available:

| | | |
|----------|------------------------------------|------------|
| JOR849 | Large Bulk Roll, 12" x 10 yds. | \$20.00/ea |
| JOR849A | Large Bulk Roll, 14" x 10 yds. | \$21.00/ea |
| JOR849B | Large Bulk Roll, 16" x 10 yds. | \$25.80/ea |
| JOR849AN | Individual, Non-sterile, 12" x 36" | \$4.10/ea |
| JOR849BN | Individual, Non-sterile, 12" x 42" | \$3.75/ea |
| JOR849CN | Individual, Non-sterile, 14" x 42" | \$4.05/ea |
| JOR849DN | Individual, Non-sterile, 16" x 54" | \$6.00/ea |
| JOR849AS | Individual, Non-sterile, 12" x 36" | \$4.80/ea |
| JOR849BS | Individual, Non-sterile, 12" x 42" | \$4.80/ea |
| JOR849CS | Individual, Non-sterile, 14" x 42" | \$4.95/ea |
| JOR849DS | Individual, Non-sterile, 16" x 54" | \$6.60/ea |



Jorvet

Equine Nylon Rope Twitch

Twitch with heavyduty nylon rope. 5" dia. loop with 25" flat handle.

| | | |
|--------|-----------------|------------|
| JOR44B | 25" Flat Handle | \$28.50/ea |
|--------|-----------------|------------|



Subpalpebral Ocular Lavage Kit

Jorvet

A silicone catheter that is surgically placed with a tunneling trocar into the subpalpebral. The special base enlays flat against the mucosa, allows ease of administration of medication for extended periods in serious ophthalmic condition.

Sterile Kit Includes:

1. silicone lavage catheter
2. trocar
3. blunt tipped (for insertion into catheter)
4. injection cap

| | | |
|---------|-----|------------|
| JOR150C | 8ft | \$53.00/ea |
|---------|-----|------------|



Jorvet Black Plastic Hoof Block

The use of hoof blocks is very popular in the treatment of hoof problems in cattle. We offer several different types.

| | |
|---------|-----------|
| JOR61BX | \$1.80/ea |
|---------|-----------|



Technovit Block (Wood)

Jorvet

The use of hoof blocks is very popular in the treatment of hoof problems in cattle. Jorvet offers several different types.

| | | |
|---------|--------------|-----------|
| JOR61B | wooden, 2" | \$1.35/ea |
| JOR61BH | wooden, 3/4" | \$1.04/ea |



Technovit 12 Treatment Kit

Kit includes Technovit liquid, powder, and your choice of hoof blocks. Also included: mixing cups and wooden stirring sticks.

| | | |
|-----------|---------------------|------------|
| JOR61T12H | w/ 1" wood blocks | \$99.75/ea |
| JOR61T12W | w/ 2" wood blocks | \$99.75/ea |
| JOR61T12 | w/ Plastic Blocks | \$96.90/ea |
| JOR61T12S | w/cow plastic boots | \$95.50/ea |

Technovit 6 Treatment Kit

Kit includes Technovit liquid, powder, and your choice of hoof blocks. Also included: mixing cups and wooden stirring sticks.

| | | |
|----------|---------------------|------------|
| JOR61T6H | w/ 1" wood blocks | \$56.50/ea |
| JOR61T6 | w/ plastic blocks | \$57.00/ea |
| JOR61T6W | w/2" wood blocks | \$63.00/ea |
| JOR61T6S | w/cow plastic boots | \$69.00/ea |



Technovit Powder

Jorvet

This popular acrylic consists of a powder and liquid that, when mixed together, form a strong binding adhesive material. The liquid and powder are mixed together in a roughly 1:2 ratio. Until it hardens, it can be poured and shaped. After it hardens, it can be sawed, drilled, or filed. It has a number of suggested uses.

- Cattle: a block or boot is adhered to the bottom of the healthy or unaffected claw, for sole abscesses or foot rot.
- Horses: quarter cracks, any hoof defects.
- Small animals: replace the connecting rod and K-E clamps for external fixation devices.

| | | |
|---------|---------|------------|
| JOR61PB | 1000 gm | \$64.10/ea |
| JOR61PA | 500 gm | \$35.60/ea |

Technovit Liquid M08

Jorvet

Introducing new, faster, and easier to use Thickened Technovit Liquid called **RAPID-VIT™**.

- No wait time between mixing and application.
- 20% pre-dissolved powder allows RAPID-VIT™ to be applied to the hoof immediately.
- RAPID-VIT™ can be shaped or formed and will not stick to WET hands.

| | | |
|----------|------------|------------|
| JOR61LAT | 240gm | \$20.05/ea |
| JOR61LBT | M08, 480gm | \$30.50/ea |
| JOR61LA | 240cc | \$20.60/ea |
| JOR61LB | 480cc | \$33.30/ea |



Technovit Cow Boot

Jorvet

slips on the healthy or unaffected claw. Stays on better than regular blocks. Inner sole is grooved for even more holding power. Blue. Can mix Technovit right in toe of the boot

| | | |
|---------|------------|-----------|
| JOR61SL | Left Claw | \$4.20/ea |
| JOR61SR | Right Claw | \$4.20/ea |

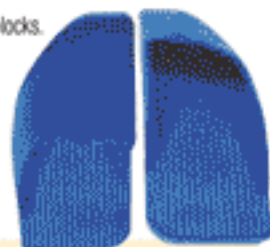

Rapid-Vit 6 Technovit Kit

An even faster technovit product with 6 boots included. Hazardous material. Requires additional shipping charges outside the continental United States.

| | | |
|-----------|------------------|------------|
| JOR61T6RV | w/plastic blocks | \$63.00/ea |
|-----------|------------------|------------|



Indwelling Uterine Infusor (sterile)

For continuous medication in the treatment of endometritis and other uterine conditions in bovine and equine. IUI is self-retaining and can be left in place until treatment is completed.

JOR198 Sterile, 30"L. \$7.20/ea **Jorvet**



Foal Nasotracheal Tube **Jorvet**

A cuffed nasotracheal tube used to deliver anesthesia gases and oxygen via nasal intubation. The tubes have a standard 15mm connector.

| | | | |
|---------|------------------------|-------------|------------|
| JOR694B | I.d. 11mm, o.d. 15.7mm | 55cm Length | \$73.00/ea |
| JOR694 | I.d. 7mm, o.d. 10.0mm | 55cm Length | \$63.00/ea |
| JOR694A | I.d. 9mm, o.d. 12.3mm | 55cm Length | \$65.00/ea |

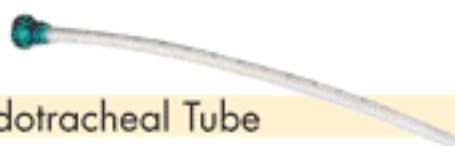

Equine Silicon Endotracheal Tube

Universal fitting allows connection to most large animal anesthesia machines and ventilators. **Jorvet**

| | | | |
|----------|--------------------------|---------------|-------------|
| JOR151XA | 16mm i.d. 8cm L Balloon | 70cm L Total | \$99.00/ea |
| JOR151XB | 18mm i.d. 8cm L Balloon | 75cm L Total | \$113.00/ea |
| JOR151Y | 24mm i.d. 12cm L balloon | 100cm L total | \$130.00/ea |
| JOR151Z | 30mm i.d. 14cm L balloon | 100cm L total | \$204.00/ea |

Equine Endotracheal Tube

Universal fitting allows connection to most large animal anesthesia machines and ventilators. **Jorvet**

JOR151X 20mm i.d. 10cm L balloon 90cm L total \$156.00/ea



Jorvet Tracheal Wash Kit **Jorvet**

Transtracheal wash is a very useful diagnostic tool in the treatment of lower respiratory disease in horses. The Jorvet Tracheal Wash kit provides a convenient and easy method to obtain high-quality diagnostic samples. The procedure is simple to perform under light sedation with a small local block over the lower third of the neck. Sterile. 15g cannula and 16g needle

JOR283 Catheter 22"L. \$12.90/ea



Silicone Adhesive

Silicone adhesive for repair of endotube cuffs.

JOR151AT for repair of endotube cuffs. Must be purchased separately \$18.75/ea

Cuff Repair Kit

Adhesive glue not included. JOR151 AT

| | | |
|------------|------|------------|
| JOR151XARC | 16mm | \$11.20/ea |
| JOR151XCRC | 22mm | \$16.00/ea |
| JOR151YARC | 26mm | \$16.00/ea |
| JOR151YRC | 24mm | \$15.60/ea |
| JOR151ZRC | 30mm | \$16.00/ea |



Equine Silicon Tracheostomy Tube

Silicone softens at body temperature for patient comfort. Balloon inflates via one-way valve. The universal attachment fits large animal anesthesia machine and ventilator hoses. Has a wide outer flexible plate for secure attachment (i.e., umbilical tape)

| | | |
|---------|---|------------|
| JOR692B | 15.0mm i.d. | \$59.75/ea |
| JOR692A | 12.0mm i.d. has 15mm connector/no balloon | \$55.90/ea |
| JOR692 | 20.0mm i.d. | \$74.00/ea |
| JOR692D | 25.0mm i.d. | \$62.00/ea |



Jorvet Hog Ringer

Die-cast aluminum hog ringer with adjustable side stop. One ring applied in nostrils discourages rooting and fence lifting.

JOR363 6 1/2"L. \$13.50/ea



Hog Holder with Lock

Jorvet Hog Holder with lock for quick release. Designed for easy catching and holding of hogs.

JOR361 New cable design with stainless steel handle. \$34.50/ea



Caesarian Forceps

With removable soft rubber jaws for grasping the uterus.

JOR15 Stainless Steel, 12"L. \$37.50/ea



Teat Supplies



Jorvet Teat Bandage

Teat injuries are serious problems and until now have been nearly impossible to properly bandage. The JorVet bandage is a cohesive polyester bandage that makes it easy to provide a protective bandage over an injured teat. **JorVet**

JOR14TB 2 1/2" W x 15'L, 5 yds. \$11.70/ea



Teat Tumor Extractor

With two cutting edges that come together for removal of fibrous tissue.

JOR11B 4.5mm dia. \$44.00/ea



Jorvet Teat Cannula

Cannula used for infusing medication into teats. Luer adaptor. Nickel-plated brass. 12/pkg.

JOR277BS 2 1/2" with two openings. Stainless Steel. (peritoneal taps) \$27.00/dz **JorVet**



Jorvet Udder Infusion Cannula

Cannula used for infusing medication into teats. Luer adaptor. Nickel-plated brass. 12/pkg. **JorVet**

JOR277A 1 1/2" with one opening. \$24.00/dz
 JOR277B 2 1/2" with two openings. \$24.00/dz



Teat Cannula **JorVet**

Fits any syringe. In handy tear-off strips. 1 1/3"L. 100/pkg.
 JOR12 100 pack \$4.50/pk



Irrigating Cannula

These plastic cannula are used for irrigation of the lacrimal ducts, wounds, glands, etc. Rounded ends. Flexible tip. Sterile. 5/pkg. **JorVet**

JOR150B Medium, 5 pack \$37.50/pk

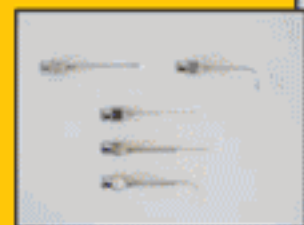

Short Nozzle Teat Cannula

4mm shaft length. This is a shorter teat cannula for customers preferring not to pass through the streak canal into the teat cistern like conventional cannulae do. 100pk in tear off strips. Sterile.

JOR12X 100/pk \$10.50/pk **JorVet**

Teat Blades

Teat Blades. These blades are designed with a specially shaped cutting edge inside the hook, making a cut in the sphincter in a manner that the outside opening of the teat canal remains whole. Stainless steel.

JOR10 Stainless Steel, 6 pack \$15.00/pk



Jorvet Teat Curette **JorVet**

JOR9 7"L., Swedish \$45.00/ea
 JOR9C 6"L., Cornell \$15.00/ea



Jorvet Teat Knife

JORSS \$15.00/ea **JorVet**

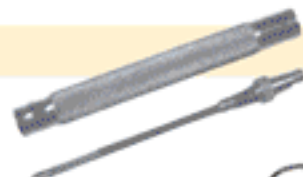

Jorvet Teat Scissors

Christensen Teat Scissors, with cutting edges on the outside of the blade; adjustable opening. **JorVet**

JOR7 6" Length \$48.00/ea



Jorvet Plastic Expandable Teat Dilator

- Soft comfortable fit
- Individually packed in handy cellophane tear-off strips
- Familiar diamond shape

JOR12D 100/pk \$16.20/pk **JorVet**



Jorvet Teat Tube Display

For cows with injured teats. Each self-retaining tube is packaged individually in a small vial. When tube has been inserted, it fits nearly flush with end of teat. No irritating thornlike protrusions (as found in other teat tubes on the market) are necessary to keep tube in place. 36/card.

JOR13 36 pack \$18.50/pk



Dr. Larsen's™ Teat Tube

This is the original Dr. Larson plastic teat tube. Also useful in treating small animal ear hematomas. Sterile. Individually packaged on a display card of 36 tubes.

JOR14L 36 pk \$84.00/pk **JorVet**



Dr. Irvin's Shurflow Teat Tube Zip Pack

JOR13Z 10 pack \$6.30/pk



NIT Teat Tools /Tentome & Lavage Admin Kits



Teat Injury Treatment. Covered or closed teat injury can be caused by being frozen, stepped upon or other trauma. A new system of conservative and natural treatment of closed teat injuries has been developed in cooperation with a European Veterinary School. The initial treatment consists of drainage of milk and antibiotic infusion with sterile flexible plastic udder infusion cannula.

NIT (Natural Insert for Teats) Teat Dilator. This short dilator consists of a natural waxy material similar to the teat's natural sebum. The teat is bandaged with teat bandage (JOR14b).

This NIT dissolves after several days. Later in the treatment regime a sterile soft flexible silicon implant is used to maintain teat canal patency.

NIT - Natural Teat Insert

JOR903 Foil packaged, 20pk \$24.60/pk

SIMPL - Silicone Teat Insert

JOR904 20pk \$29.40/pk

Plastic Sterile Teat Infusion Cannula

JOR905 Disposable, Sterile, 10pk \$21.00/pk



X-Long Teat Tube

Brass stylett is left in tube only during insertion for stiffness. Plastic, flexible, and self-retaining. Sterile. Unit separately packaged in cellophane bag.

JOR13L 3"L. 12/pk. \$16.50/dz



Viscera Retainer

Effectively retains viscera and omentum during surgical closure of peritoneal cavity. It provides added anchorage and retentive power, yet folds into a narrow roll for easy removal when the incision is almost closed. Silicone; autoclavable.

JOR208B Equine, 9" x 14" \$97.00/ea



Vienna Double OB Hook

Stainless Steel. Hinged for easier placement.

JOR19V 5 1/2"L. \$30.00/ea



Lichty Teat Knife

JOR9LB Stainless steel, 5 1/2"L, blunt

\$15.00/ea



Tenotome JorVet

| | | |
|---------|--|------------|
| JOR88A | Small, Blunt and Curved, 15 x 3mm blade. | \$9.90/ea |
| JOR88BC | Blunt and curved, 5cm x 1/2cm blade. | \$24.00/ea |
| JOR88S | Blunt and Straight, 5cm x 1/2cm blade. | \$24.00/ea |
| JOR88SC | Sharp and Curved, 5cm x 1/2cm blade. | \$24.00/ea |

Tendon Splitter JorVet

Double edged blade. Stainless steel.

JOR89 4cm L blade. \$15.00/ea



Equine Uterine Lavage Administration Kits

These large bore tubing kits are designed to connect large Foley catheters for large volume infusion and collection. The "Y" junction allows for fluid infusion and outflow for drainage or collection. Sterile.

Long tubing with "Y" junction. Extra long tubing 60" (5 ft) both inflow and outflow gives room for fluid administration and collection away from the animal. Attached large bore spikes for inflow at proximal end. The distal end has a barbed fitting for connection to Foley catheter.

JOR1052 60" (5 ft) \$9.60/ea

These large bore tubing kits are designed to connect large Foley catheters for large volume infusion and collection. The "Y" junction allows for fluid infusion and outflow for drainage or collection. Sterile.

Short 6" inflow with female spin luer lock adapters. This allows hookup to syringe or another administration set. There is a 30" outflow tube. Distal end has a barbed fitting for connection to Foley flushing catheter (JOR282).

JOR1052A \$6.45/ea

These large bore tubing kits are designed to connect large Foley catheters for large volume infusion and collection. The "Y" junction allows for fluid infusion and outflow for drainage or collection. Sterile.

Single line with 60" large bore tubing with proximal spike and distal barbed fitting for attachment to Foley or large bore pipette (JOR286).

JOR1052B \$6.45/ea



JOR1052

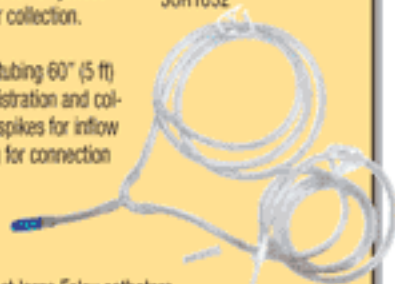

JOR1052A



JOR1052B



Hoof Tools

Hoof Knife

- JOR32HLE Left, Economy, Ebony \$9.75/ea
 JOR32HRE Right, Economy, Ebony \$9.75/ea



Left Curve Hoof Knife

- JOR32HML Wood Handle, Left, Curved, Blade 5/8" W x 2 3/4" L. \$30.90/ea



Right Curve Hoof Knife

- JOR32HWR Wood Handle, Right, Curved, Blade 5/8" W x 2 3/4" L. \$30.90/ea



Hoof Knife

Hoof Knife with small curl, double edge. Blade 5/8" W x 2 3/4" L.

- JOR34L Left handed only, ergonomic shaped wood handle. \$45.00/ea
 JOR34CLE 5/8" W x 2 1/2" L., Left, Economy \$9.00/ea
 JOR34CRE 5/8" W x 2 1/2" L., Right, Economy \$9.00/ea
 JOR34CNLE 3/8", Left, Economy \$9.00/ea
 JOR34CNRE 3/8", Right, Economy \$9.00/ea



Jorvet Oval Hoof Knife

- JOR340 \$38.00/ea



Hoof Knife Hone



JOR33H

Especially developed for hoof knives and will sharpen inside of curl.

- JOR33H \$13.50/ea

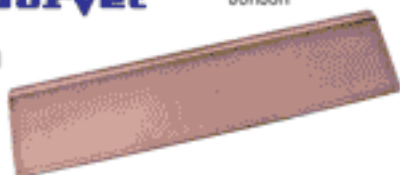

Jorvet Hoof Buffer

- JOR61H \$37.00/ea



JOR61H

Hughes Hoof Groover



Hugh's Angled Hoof Groover. This hoof groover has an elliptical doughnut-shaped working end. Elliptical opening is 2cm x 1cm. The bottom portion is sharpened. It is great for digging out or curetting hoof abscesses. Stainless steel handles.

- JOR32HG 6 1/4" (16cm) L. Curved \$18.00/ea
 JOR32HGS Straight \$18.00/ea



Hoof Tester



- JOR35P Special Size, Stainless steel. 13". \$33.00/ea

Adjustable Hoof Tester

This sturdy model hoof tester has jaws of stainless steel.

- JOR35F Seven adjustments for every size hoof. \$145.00/ea

Hoof Tester



Jorvet Standard Hoof Tester.

- JOR35LP Large, Stainless steel. 13". \$42.00/ea
 JOR35B 14 1/2". \$120.00/ea

Hoof Tester

Extra large hoof tester. 21". Max jaw opening is 20cm (8") which is much larger than standard tester. Jaw teeth are large cleats for better hold.

- JOR35XL Stainless Steel, 21" \$80.00/ea



Ryding Hoof Tester

New design allows for adjustable jaws over entire hoof surface. The jaws remain parallel for more even and steadier diagnostic pressure. The handle accommodates one-handed use, leaving the other hand free to hold the leg or for positioning the hoof. Stainless steel.

- JOR35EC Stainless steel. \$185.00/ea



Hoof Trimmer



Popular compound action steel model, with extra sharp blades that are replaceable. Green with black handle grips.

- JOR35 Steel, 20" \$125.00/ea

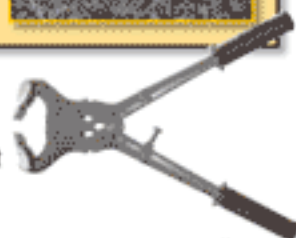

Foot-Rot Hoof Shears

Heavy handles as illustrated, with strong spring and safety clip. Specially designed tempered steel serrated blades.

- JOR131M Stainless steel. \$18.00/ea



Hoof Knife Set

- JOR32HSE Economy \$60.00/ea

Folding Hoof Knife

Folding Hoof Knife combined with hoof pick. Handy pocket size.

- JOR32F Handy Pocket Size \$10.50/ea



Tatto Supplies & Suture Kits

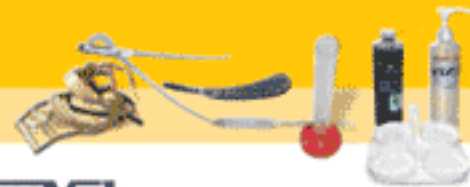

Free Martin Probe



The JorVet Freemartin Probe is a newly developed vaginal probe to detect freemartin heifers and/or determine if heifers born co-twin to a bull have a normal reproductive tract. The crucial probe end length is 7cm. Research has shown that no freemartin calf has a vaginal length longer than 7cm. The distal end of the narrower center section is 14cm from the tip. Over 95 percent of heifers born co-twin to a bull and with a normal reproduction tract have a vaginal length of 14cm or more. Animals with a vaginal length of 7-14cm should have chromosome testing done to confirm if a freemartin. This probe is designed to be used on heifers 30 days of age or less.

JOR99FM \$27.00/ea **JorVet**

Lamb Nipple **JorVet**

Natural feeling rubber with "X" pierced tip fits most soda type bottles. Raised ridge inside helps hold nipple onto bottle. Side tab helps pull off and on.

JOR920 Black, 4/pack \$3.00/ea
 JOR920R Red, 4/pack \$3.00/pk



Lambing Snare

Small plastic snare with "Y" configured head. Nylon covered steel cable. Helps in holding the lamb's head until the feet can be reached.

JOR921 \$22.50/ea



Small Animal Electric Tattoo Kit

Complete tattoo kit in an attractive foam-padded case. This state-of-the-art animal marker features fingertip control for precise and accurate tattooing on the smallest of animals.

JOR276 Kit includes: \$546.00/ea

- Foam padded case
- Finger tip control
- Three needle bars
- Black tattoo ink
- 110V AC current.



Power Supply

JOR276D4 For Jor276 \$140.00/ea

Tattoo Pliers

Used for positive permanent livestock identification. Heavy-duty construction. Marker jaws holds four easily interchangeable letters or digits. Digits only go in one way. Positive ear release.

JOR642 • Marker jaws holds four easily interchangeable letters or digits. \$24.00/ea
 • Digits only go in one way.
 • Positive ear release.

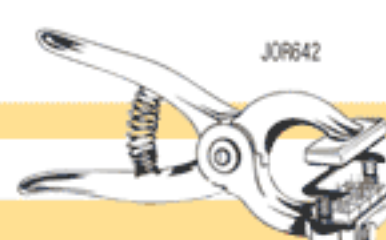

Small Tattoo Plier

JOR641S \$18.00/ea

Tatto Digits

JOR641SL A-Z, 5/16" \$24.00/ea
 JOR641SN 0-9, 5/16" \$9.00/ea

Jorvet Tattoo Ink

Widely used for identification in livestock, especially cattle and swine. Jorvet tattoo ink is easily read years after tattooing. Now Jorvet has expanded the range of permanent tattoo inks. Inks are available in black and green, and varied packaging. **JorVet**

JOR276PG green paste, 5 oz. \$18.90/ea
 JOR276PGS green paste, 1 oz. \$6.60/ea
 JOR276RB black, roll-on, 2 oz. \$6.90/ea
 JOR276RG green, roll-on, 2 oz. \$7.35/ea
 JOR276T black, 2 oz. \$15.00/ea



Suture Kit

JOR91KA Equine, Size 0 Braunamid with #2 3/8 reverse cut suture needle \$4.80/ea
 JOR91KB Bovine, #3 Braunamid suture with XL 3/8 reverse cut needle \$5.40/ea

Suture Kit Calves & Pigs

JOR91KD Calves and Pigs, Braunimid 60" long with size 2 needle, 3/8 reverse cut \$5.40/ea

DA Toggle Suture

used in the Grymer/Stern method for nonsurgical percutaneous fixation of the left displaced abomasum (LDA).

JOR191 Pair \$8.40/pr

LDA Toggles Suture Button

This suture button has a number of different applications in bovine surgery the most common being LDA's. It is a flat pliable oval shaped disc with four round contoured holes. It helps reduce suture tension by distributing the pressure over a wider surface area. Suggested uses:

- LDA toggle button repair
- Uterine/vaginal prolapse repair
- Umbilical hernia in calves
- Measures 4" Long x 15/8" Wide x 1/16" Thick
- 6 buttons/pack
- Neon green color for easy observation
- Complete directions included

JOR191B 6pk. \$8.10/pk

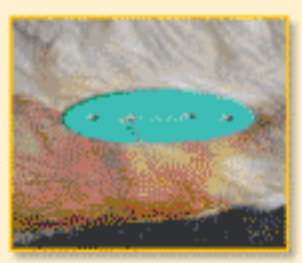
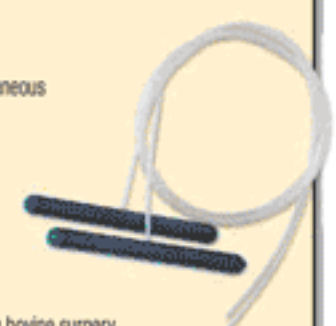

See our Suture & Skin Closure Section for a full line of Suture Products

Parson's Walking Casts Products



Parson's Full Walking Cast

Spans from the upper cannon bone to the bottom edge of the hoof. It will immobilize both the fetlock and pastern joints. A rigid section of special unbreakable plastic is sewn and enclosed in a neoprene protective sheath. The brace is placed down the cranial part of the lower leg. It is attached by stretchable neoprene straps with velcro. The brace can be safely put on or taken off in seconds even by the horse owner. It can be washed and reused repeatedly. The price is half of the cumbersome ski boot style brace plus is lightweight and well-tolerated by the equine patient. 7" w x 13" h, secured by three attached 4" x 24" neoprene stretchable straps with double velcro closure. Washable neoprene construction. Padded for multiple day use.

JOR637 \$199.00/ea



Parson's Equine Wrap

This special neoprene stretchy wrap with velcro straps can take the place of expensive bandage materials like Elastikon® or Vetrap™. Especially true when numerous bandage changes are needed over time. It can be washed and reused repeatedly.

JOR637B 4" Wide x 48" long, 2 pack \$33.00/pk
 JOR637C 2" Wide x 24" Long, 6 pack \$21.00/pk

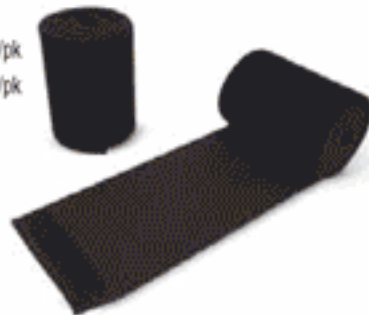

Parsons 4- Strap Leg Stabilization

Designed to place over the carpus down to top of hoof wall for stabilizing and support.

- Reinforced rigid insert for stability
- Washable neoprene construction
- 4 to 5 attached plastic neoprene straps
- Self padded for short term, use cotton under lays as needed for long term
- Can be placed on front or either side of leg



JOR637CLS Colt Leg Stabilizer 4 strap 5 1/2" w X 18" h \$280.00/ea
 JOR637HLS Horse Leg Stabilizer 5 Straps, 6" x 23" \$350.00/ea

Parson's Lower Leg Brace

Also spans from the upper cannon bone to the bottom edge of the hoof. It will immobilize the fetlock and pastern joints. A rigid section of thick unbreakable plastic is sewn and enclosed in a neoprene protective sheath. Conventional bandages like Elastikon® or Vetrap™ are used to hold it in place. Parsons' wrap is even better to use. Again, this brace is simple to put on and take off and is fully washable. Padded for one day use. 5 1/2" w x 13" h. Washable neoprene.

JOR637A 5 1/2" w x 13" h. Washable neoprene. \$99.00/ea



Parson's Foal/Calf Flexor Tendon Brace

For contracted flexor tendons in young foals and calves. This concave brace is placed over the back of the front leg for reinforcement and stability.

- Washable neoprene construction
- Reinforced insert for stability
- 2 elastic straps attachment to brace
- Self-padded for short term use

JOR637TS 3.5" w X 9" h \$120.00/ea



Parsons Bowed Tendon Correction

This rigid concave brace is designed to fit over the flexor tendon for support in case of "Bowed tendon". It is self-padded with reinforced insert for stability. Made from washable neoprene. Can be used alone or in conjunction with Parsons walking cast.

JOR637BT 2" w x 7" long. \$42.00/ea



JorVet Prolapse Kit

A kit for the correction of preparturient vaginal prolapse. This kit consists of 2 large buttons connected with a plastic rod that retains the vagina in place. Calving can take place with no interference. Detailed instructions included.

JOR359 \$4.80/ea **JorVet**

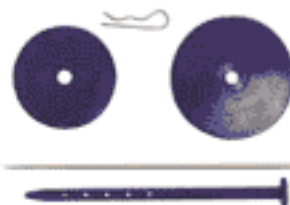

Catheters

Silicon Foley Catheter

Silicone is the preferred material for foley catheters. This catheter softens at body temperature. Equipped with a one-way valve for balloon inflation. Sterile.

| | | |
|---------|--|------------|
| JOR693 | 5fr o.d. x 30cm L, White Opaque | \$44.80/ea |
| JOR693A | 6fr o.d. x 30cm L, 1.5cc balloon w/stylet, Clear | \$15.00/ea |
| JOR693B | 8fr o.d. x 30cm L, 3cc balloon w/stylet, Clear | \$9.30/ea |
| JOR693C | 10fr o.d. x 30cm L, 3cc balloon w/stylet, Clear | \$9.90/ea |
| JOR693D | 12fr o.d. x 40cm L, 5cc balloon, Clear | \$9.00/ea |
| JOR693Y | 10fr o.d. x 55cm L, 3cc balloon, White opaque | \$39.00/ea |
| JOR693W | 5fr o.d. x 55cm L, 2cc balloon, White Opaque | \$56.00/ea |
| JOR693X | 8fr o.d. x 55cm L, 3cc balloon, White Opaque. | \$44.80/ea |



Extended Use Polyurethane Catheter

Most traditional jugular catheters are teflon. They can create a thrombosis and crack if left in place for over 48 hours. The development of new materials allows large-bore catheters that can safely be left in-dwelling for up to 10 days. The JorVet Extended Use Catheter softens at body temperature. Many of the common catheter-related problems, such as phlebitis, can be minimized with these catheters.

- 14g and 16g polyurethane catheter over needle
- Non-thrombogenic and non-cracking
- Can be safely left in the vein for up to 10 days
- This same catheter is used in 24 out of 27 U.S. veterinary teaching hospitals
- Suture wings with holes or suture groove attachment

| | | |
|---------|----------------|------------|
| JOR458A | 14g x 5 1/4" | \$10.50/ea |
| JOR458B | 16g x 5 1/4" | \$10.50/ea |
| JOR458C | 16g x 3", foal | \$10.80/ea |



Large Stallion Silicone Foley Catheter

| | | |
|----------|---------------|------------|
| JOR693SA | 28fr. X 75cm | \$50.50/ea |
| JOR693SB | 28fr. X 100cm | \$57.00/ea |
| JOR693SD | 12fr. X 150cm | \$65.00/ea |



Stallion Catheter

Stallion Urinary Catheter. Used in both geldings and stallions. Flexible plastic with plastic stylet. Sterile. 6.6mm x 137cm L.

| | | |
|--------|--------|------------|
| JOR90S | 137 cm | \$11.10/ea |
|--------|--------|------------|

Mare catheter, 60 cm

| | | |
|---------|---------------|------------|
| JOR90SM | 8.6 x 60cm L. | \$11.10/ea |
|---------|---------------|------------|



Equine Uterine Lavage "Y" Catheter

"Y" connector, with 12" arms, gives in flow and out flow. Two shut-off clamps. Two different adaptors included.

| | | |
|----------|-------------------------------|------------|
| JOR282YL | Complete "Y" System, 135cm L. | \$66.00/ea |
| JOR282Y | Complete "Y" System, 95cm L. | \$54.00/ea |

Mare Catheter

MMare Urinary Catheter. Metal with ring.

| | | |
|--------|-------------|------------|
| JOR90M | 30cm x 8mm. | \$22.50/ea |
|--------|-------------|------------|



Silicone Equine Flushing Catheter

Large silicone catheter with large Foley inflatable balloon.

- Embryo transfer/collection
- Lateral eyes on open ended tip
- Inflatable balloon allows fluid retention in uterus when the catheter is passed beyond the cervix.
- Diameter: 33fr (8mm i.d. x 11mm o.d.)
- Includes two different adaptors

Reducing Connector (JOR282d2) to attach tubing
Barbed Connector (JOR282d1) with standard luer fitting

| | | |
|---------|----------|------------|
| JOR282 | 65cm L. | \$48.00/ea |
| JOR282L | 135cm L. | \$57.00/ea |

Allows connecting of syringe to catheter

| | | |
|----------|--|-----------|
| JOR282D1 | Allows connecting of syringe to catheter 4mm to 6mm. Not tapered | \$3.30/ea |
|----------|--|-----------|

Double Christmas Tree Connector connects tubing from 4mm to 12mm I.d.

| | | |
|----------|---|-----------|
| JOR282D2 | Connects tubing from 4mm to 12mm I.d. 2/pkg 4mm to 6mm. Not tapered | \$3.00/ea |
|----------|---|-----------|

Smaller Barbed Connector with female luer lock. 2.8mm-7mm.

| | | |
|----------|----------------------------|-----------|
| JOR282D4 | w/female luer lock 2.8-7mm | \$3.60/ea |
|----------|----------------------------|-----------|

Smaller Christmas Tree Connector. 4mm to 6mm. Not tapered.

| | | |
|----------|-----------------------------|------------|
| JOR282D3 | 2pk 4mm to 6mm. Not tapered | \$6.00/pkg |
|----------|-----------------------------|------------|



Jorvet Large Animal IV Catheter

Large animals need large volumes of IV fluids in a short period of time. Naturally, the IV catheter needs to be a large bore, and often is even put in bilaterally to maximize fluid administration speed.

Features:

- Large bore: 10g and 14g catheters. The 10g is the largest available.
- Longer lengths: 51/2" catheter lessens the risk of pulling out the catheter.
- Pebax® catheter implant grade material: much less bioactive to lessen thrombosis formation for long term >3 days placement.
- Kink resistant: other catheters like Teflon will kink upon bending, making them unusable.
- Clear catheter material versus opaque Teflon.
- Suture patch: a thin, flexible patch with twin eyelets. Allows suturing in place or hold with tissue adhesives. Reduces catheter pull-out.
- Competitive pricing and available through JorVet distributors.

| | | |
|---------|-----------|------------|
| JOR457A | 14g x 5.5 | \$10.20/ea |
| JOR457B | 10g x 5.5 | \$10.50/ea |

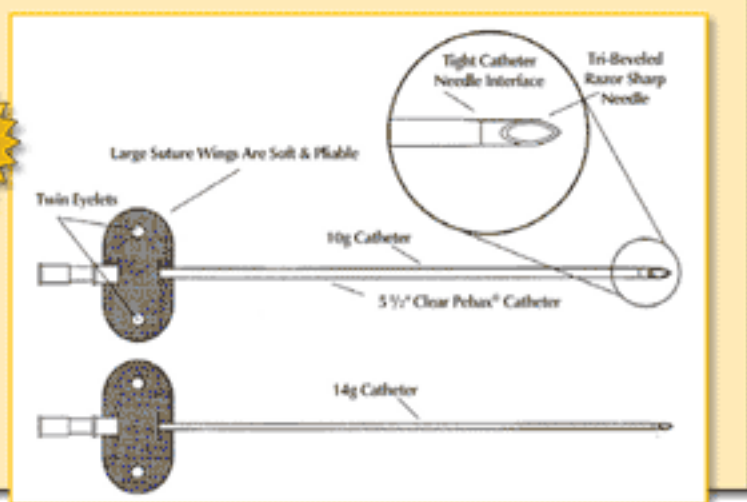

Large Animal Supplies

Needles & Fetotomy Supplies



Winged IV Infusion Set

These popular sets are commonly known as Butterfly® style IV sets. They are great for short term IV infusion or in difficult venipunctures. Tubing with female luer fitting is 12" long. A 3/4" razor-sharp needle is attached to flexible colored coded wings.

| | | |
|---------|--------------------------------|-------------|
| JOR454A | 19g. Yellow, Sterile. 100/box. | \$25.00/box |
| JOR454B | 21g. Green, Sterile. 100/box. | \$25.00/box |
| JOR454C | 23g. Blue, Sterile. 100/box. | \$25.00/box |
| JOR454D | 25g. Orange, Sterile. 100/box. | \$25.00/box |

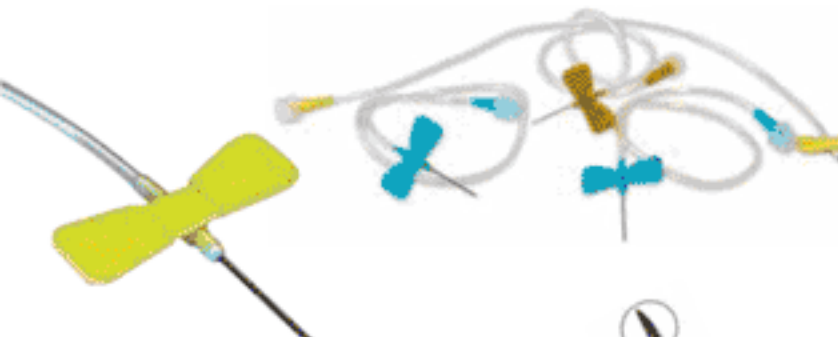

Jorvet Bleeding Needle

Dozen, Stainless Steel

| | | |
|---------|------------------|------------|
| JOR199A | 16g x 3", 12/pk. | \$30.00/dz |
| JOR199B | 15g x 3", 12/pk. | \$30.00/dz |
| JOR199C | 14g x 3", 12/pk. | \$30.00/dz |



Jorvet Needle Bar

| | | |
|----------|-----------------------|------------|
| JOR276D1 | 5 pack (with needles) | \$53.00/pk |
|----------|-----------------------|------------|

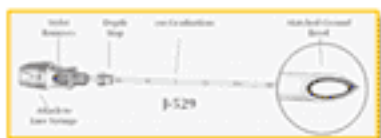

Spinal Needles

Spinal Needle. General purpose aspiration biopsies and drainage procedures. Matched ground bevel eliminates possibility of tissue coring. Attaches to standard luer fitting. Available with echogenic enhanced tip (ultra-sound). Not autoclavable. Sterile.

| | | |
|---------|-------------------------------------|------------|
| JOR529F | Unmarked Needle. 22g x 9cm (35/8"). | \$10.50/ea |
|---------|-------------------------------------|------------|

True Cut Style Biopsy Needle

Long enough to reach any biopsy site. 1mm x 20mm specimen chamber.

| | | |
|---------|------------------|------------|
| JOR118D | 18g x 10cm (4"). | \$25.50/ea |
|---------|------------------|------------|



Jorvet Feeding Needle

Luerlock hub with stainless steel tube and nickel-plated silver ball on the end.

| | | |
|-----------|--------------------|------------|
| JOR194SDH | 14g X 4", Straight | \$46.00/ea |
| JOR194SDH | 14g X 4", Curved | \$46.00/ea |



Fetatome Case

This vinyl case is a great organizer with individual pockets for OB handles, wire saw, chains and other OB equipment. Also protects fetatome from scratches and wear.

| | |
|--------|------------|
| JOR18C | \$45.00/ea |
|--------|------------|



Fetotomy Procedure Booklet

| | |
|----------|------------|
| JOR18USB | \$20.00/ea |
|----------|------------|

Thygesen Fetatome with Coil

Two-tube model with adjustable handle for OB chain. This is the breakdown model, complete with insertion coil and cleaning brush.

| | | |
|--------|-------|-------------|
| JOR18T | 33"L. | \$352.00/ea |
|--------|-------|-------------|

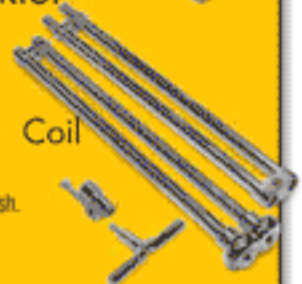

Insertion Coil and Brush

| | | |
|--------|---------------|------------|
| JOR18I | for fetatomes | \$39.00/ea |
|--------|---------------|------------|



Utrecht Fetatome with Coil

Lightweight model Utrecht Fetatome, with hardened metal head. Includes modified grip with notched plate for OB chains. Complete with insertion coil and cleaning brush.

| | | |
|---------|-------|-------------|
| JOR18US | 38"L. | \$332.00/ea |
|---------|-------|-------------|



Jorvet Nano Paste Syringe

The use of bioscaffold materials is gaining widespread use in veterinary surgery especially for procedures like TTA. The challenge has been getting formulations that are easy or simple to use. Nano Paste is a white paste formulation that comes in a small sterile syringe. It is easily and precisely injected into the surgery site. There is no remixing freeze-dried granules or trying to pack in putty. Nano Paste has a proven ingredient of bioceramic hydroxyapatite. Hydroxyapatite has been used for over 20 years in human orthopedic medicine with numerous research articles pointing to its efficiency. It is not a bioglass dental putty that must undergo a reaction i.e. biomimetic. Nano Paste has ultrafine particles that allow a huge surface area for new bone cells to migrate into and readily start osteosynthesis. Use for: TTA procedures, Nonunions, Arthrodesis, or Augmenting an autograft.

| | | |
|---------|-------|-------------|
| JOR338 | 2.5gm | \$110.00/ea |
| JOR338A | 5gm | \$160.00/ea |





Cal-Gel® cartridge

a specially-formulated mineral supplement for use in dairy cows. It is an aid to maintaining normal calcium levels during the critical immediate pre-partum and post-partum periods. Cal-Gel comes in a standard dosing cartridge and is administered orally. Based on a Danish formulation used for over 20 years it delivers calcium together with magnesium and cobalt at a balanced pH.

JOR294 12 cartridges/display case. \$67.00/dz

JorVet



Milk Tubes

Self-retaining. Smooth retaining bulbs.

JOR278B 2 1/2", 1 dozen \$21.00/dz
 JOR278A 2", 1 dozen \$21.00/dz
 JOR278C 3", 1 dozen \$21.00/dz



JorVet

Ketogel **JorVet**

Ketogel™ is a concentrated energy gel packed with vitamins, amino acids, and trace minerals. It is designed to be used to help maintain normal blood glucose (sugar) during periods of stress (i.e., difficult calving and metritis). This stress period often leads to ketosis (acetonemia). The administration of an oral product often is a follow-up to an intravenous treatment of dextrose or glucocorticoids.

- Energy Source. Ketogel™ provides 290 grams of propylene glycol. This is rapidly absorbed directly from the rumen to the liver and converted to glucose.
- Vitamin A (40,000 Units), Vitamin D (10,000 Units), Vitamin E (100 Units). The ruminant is unable to synthesize these vitamins. There is an increased demand during periods of stress.
- Niacin (6 Grams) has a role in increasing glucose production and decreasing fat mobilization.
- Choline (6 Grams) and Methionine (6 Grams) are methyl group donors and have an important role in the regulation of fat deposition in the liver.
- Cobalt is a precursor of Vitamin B12. This is an important co-factor in glucose production.

JOR306 Dozen \$78.00/dz

Cartridge Dosing Gun

JOR294G \$39.00/ea

JorVet



Rubberized OB Suit **JorVet**

Rubberized OB Suit. With pants and jacket.

JOR30SR-S Small, (2 pc) \$188.00/ea
 JOR30SR-M Medium (2pc) \$183.00/ea
 JOR30SR-XL X-Large (2 pc) \$183.00/ea

OB Rubber Smock **JorVet**

This smock features the special easy-to-clean arm shields. Very durable.

JOR30R-L Large \$113.00/ea
 JOR30R-S Small \$110.00/ea
 JOR30R-XL X-Large \$113.00/ea
 JOR30R-M Medium \$113.00/ea

Rubberized OB Jacket

Rubberized OB Jacket only

JOR30JR-S Small \$110.00/ea
 JOR30JRXL X-Large \$126.00/ea

JorVet

Rubberized OB Overalls

Easy to snap-on Suspenders. Size XL.

JOR30OS Small \$104.00/ea
 JOR30OM Medium \$104.00/ea
 JOR30OL Large \$110.00/ea
 JOR30OLX X-Large \$104.00/ea

Rubberized OB Pants

Rubberized OB Pants only.

JOR30PR-S Small \$73.00/ea
 JOR30PR-L Large \$73.00/ea



JOR30JR & JOR30PR

Rubberized OB Apron

Rubberized OB Apron. Suitable for wearing in conjunction with JOR29 or JOR29c.

JOR29A Rubberized, 120cm or 48" L \$37.50/ea

OB Shoulder Protector

This is the original Danish import, where the arm passes through an opening in the special easy-to-clean rubber shield. There's no bunching of the material in the arm area. If worn in conjunction with a rubber apron, it serves as an OB smock. Protector ties under opposite arm.

JOR29 Heat-sealed seams \$45.00/ea

OB Shoulder Cuff **JorVet**

Basically the same as JOR29 above, but less area is covered. Very handy in conjunction with disposable or rubber sleeves.

JOR29C Heat-sealed seams \$33.00/ea

Total OB Sleeve **JorVet**

The "Total" OB Sleeve. This new product gives additional coverage to the whole shoulder and under arm area. No need for clamps to hold in place or a separate shoulder protector. Helps reduce laundry expense and reduces accidental manure stains and smell. This glove is sensitive but strong, 1-mil thick with strong smooth seams. Package is 50 sleeves in a pull out dispensing box.

JOR300D Regular (Box of 50) \$21.00/bx
 JOR300DS Small (box of 50) \$18.00/bx



Disposable Plastic Boots

Fits over cowboy boots and large work shoes.

Handy tie feature keeps boots on tight. Blue.

JOR100BL Heavy 4 mil thickness. 21"H x 16"L. 50/bag. \$18.45/pk

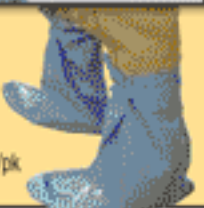

Spare Rubber Rings

Spare rubber rings for OB cuffs

JOR29D \$7.50/ea

JorVet



| | | | | | | | |
|--|---------------|---|---------------|--|-------------------|---|----------|
| Clamps, Backhaus Towel | 84 | Compression Bone Plating Basic Kit | 245 | Cruciate Needle | 259 | Dematter | 151 |
| Clamps, External Fixation | 238 | Compression Plates | 245-248 | Cruciate Repair CD/Rom | 262 | Dentacetic Dentees | 160 |
| Clamps, Umbilical | 103 | Con-Trate® Fecal Filters | 288 | Cruciate Repair Crimping Forceps | 259 | Dental, Equine | 92 |
| Classic Series Medical Seating | 218 | Concentrate, Instrument Lubricant | 271 | Cruciate Repair Kit TTA | 257 | Dental, Equine Universal | 350 |
| Clean and Fresh Oral Spray | 159 | Concentrate, KOE Kennel Odor Eliminator | 276 | Cruciate Staples | 254 | Dental Burr Block | 342 |
| Cleaner, Clipper | 155 | Concentrators, Integra & Ragalia Oxygen | 301 | Crusher, Pet Pill | 159 | Dental Curette | 339 |
| Cleaner, Disinfectant | 273 | Conditioner, Malacetic | 158 | Crusher-Splitter, Pill | 200 | Dental Elevators | 340 |
| Cleaner, Ear | 162 | Condom, Jorvet Equine | 358 | Cryosurgery Items | 217 | Dental Extraction Kit | 339 |
| Cleaner, Enzymatic Instrument | 271 | Condyle Clamp | 84, 265 | Cryosurgery in Horses Handbook | 333 | Dental Files | 339 |
| Cleaner, Foaming Autoclave | 270 | Cone, Otscope | 280 | Crystal Eye | 158 | Dental Float w/Fistol-Grip | 346, 351 |
| Cleaner, Nolvasan S | 270 | Cones, Bull Semen Collection | 334 | Crystal View with Wood Base | 327 | Dental Forceps | 343 |
| Cleaner, Surgical Enzyme | 270 | Connecting Rods | 237 | CSR Wrap | 115 | Dental Hand Instrument Tray | 342 |
| Cleaner, Ultrasonic | 275 | Connector, Barbed | 207 | Cube, Buster | 145 | Dental Handpiece Lubricant | 335 |
| Cleansing Towlette | 274 | Connector, Barbed Oxygen | 303 | Cuff, Doppler | 289 | Dental Mirror | 341 |
| Clear Elizabethan Collar | 135 | Connector, Christmas Tree | 312 | Cuff, Jorvet Disposable Blood Pressure | 289 | Dental Model | 331 |
| Click Style Oxygen Regulator | 303 | Connector, Double Christmas Tree | 207 | Cuff, OB Shoulder | 133, 188, 371 | Dental Prophylaxis Kit | 339 |
| Clinch Cutter | 104 | Connector, Swivel | 311 | Cuffed, Red Rubber | 308 | Dental Scraper | 341, 352 |
| Clinical Refractometer | 289 | Connector, Y Barb | 131 | Cuffed Endotracheal Tube | 308 | Dental Stick | 146 |
| Clip, Bone Plate | 252 | Connector, Anesthesia Elbow | 312 | Cuff Repair Kit | 310, 363 | Dental Wedge | 337 |
| Clip, Light Conducting Rod with | 295 | Connector Dual, Anesthesia Hose | 312 | Culture Swab | 325 | Dental X-ray Film Mounts | 329, 344 |
| Clippers | 153, 154, 156 | Constrictors, Ameriod | 109 | Cup, Graduated | 127, 212 | Dentees, Dentacetic | 160 |
| Clipper, Hauptner | 349 | Consulting Otscope Head | 281 | Cup, Souffle | 200 | Deodorant, Four Paws Instant Dry Shampoo & | 158 |
| Clipper Blade Oil | 155 | Container, Formalin-Filled | 326 | Cups, Medication | 361 | Deodorizer, Aerosol | 274 |
| Clipper Cleaner | 155 | Container, Linear Fixation | 239 | Cups, Rubber | 336 | Deodorizer, Citrus II | 276 |
| Clipper Holder | 155 | Container, Sharps | 198 | Cups, Screw-On Propyl | 336 | Deodorizer, Metrimist | 273 |
| Clips/Applicators, Jorvet Hemostatic Ligation | 48 | Container, Specimen | 200 | Curettes | 95, 267, 339, 364 | Depressor, Tongue | 124 |
| Closed Block Scrub Brush | 115 | Contra Angle | 336 | Curved Feeding Needle | 66 | Depth Gauge | 260 |
| Closed Probe | 217 | Control, IV Extension Set w/Flow | 202 | Curved Graft Passer | 263 | Derf Needle Holder | 76 |
| Closed Wound Drainage Kit | 131 | Converter, Bipolar | 214 | Curved Needles | 66 | Dermal Curette | 95 |
| Closeout Suture Singles | 52 | Cookie Nut Ring | 144 | Cushion, Gel Foam | 220 | Dermatophyte Test Medium | 296, 326 |
| Closures, StaySafe - Self-Sealing Bottle | 334 | Coplin Jar | 320 | Cushion, Rubber Tube | 316 | Desmarrés-Chalazion Forceps | 79 |
| Cloth Instrument Wrap | 115 | Cordless Cautery Convenient Kit | 120 | Cut-Heal Wound Spray | 161 | DesMarrés Lip Retractor | 97 |
| Cloth Reusable Surgeon Gown | 110, 186 | Corkscrew Trocar with Plastic Stylet | 240 | Cut-Pad Dog Pad Protector | 161 | Detergent, Germicidal Disinfectant | 273 |
| Cloud 9 Warming Unit | 128 | Correction, Parsons Bowed Tendon | 368 | Cutter, Bird Leg Ring | 144 | Detergent, Manual and Ultrasonic Instrument | 271 |
| CMT Test Kit | 354 | Cortical Nut | 241 | Cutter, Enclosed Bone Pin | 103, 241 | Detorsion Bar | 354 |
| Co-Flex® Tape | 178 | Cortical Screws | 246, 248, 250 | Cutter, Engel Cast | 259 | Diagnostic 2.5V Otscope with Specula | 281 |
| CO2 Laser System Kit | 132 | Cortical Self-Tapping | 242 | Cutter, Equine Molar | 345 | Diagnostic Set | 280 |
| Coat, Disposable Lab | 189 | Cotton-Tipped Applicators | 124 | Cutter, Finger Ring | 109 | Digital MacroView™ Veterinary Otscope | 281 |
| Coat, Lab | 189 | Cotton Cast Padding | 230 | Cutter, Jorvet K-Wire | 268 | Digital Thermometer | 297 |
| Coated Cage Rack | 224 | Cotton Roll | 173 | Cutter, Jorvet Rodent Molar | 105 | Digits, Tatto | 367 |
| Coated Sontara Drape | 113 | Cotton Rope Handle w/Tennis Ball | 145 | Cutter, Jorvet Small Angles Bone | 91, 268 | Dilator, Jorvet Rodent Cheek | 337 |
| Coban® Tape | 178 | Cotton Stockinette | 230 | Cutter, K-Wire | 99 | Dilator, Plastic Expandable Test | 364 |
| Cochran Dental X-ray Positioner | 344 | Counter, Cell | 321 | Cutter, Pin | 103, 240 | Dilator, Rodent Cheek | 105, 337 |
| Cochran IV Splint | 205 | Counter, Hand Held Tally | 321 | Cutter, Rodent Molar | 337 | Dilator, Oxygen | 299 |
| Cold Sterilization Storage Tray | 272 | Counter, Needle | 62 | Cutter, Tooth | 342, 352 | Diners, Double | 210 |
| Cole, Avian/Small Exotic | 309 | Countersinks | 256 | Cutter, Wire Twister/Shear | 100 | Director, Grooved Probe | 102 |
| Collars | 135-138 | Country Dreams Bed | 166 | Cutter/Shearer, Rib | 102 | Disarticulator, Femoral | 101 |
| Collar, Halti Head | 141 | Covault Retractor | 96 | Cytology Swabs | 325 | Discofix 3-Way Stop Cock | 202 |
| Collar, X-Ray Thyroid | 329 | Cover, Catheter and Instrument Tray with Dome | 211 | D | | Disinfectants | 273 |
| Cologne, Four Paws | 158 | Cover, Catheter and Instrument Tray with Flat | 211 | Dandy Nerve Hook | 96 | Dispenser, Acrylic Exam Glove | 176 |
| Colostrometer, Bovine | 353 | Cover, Freeman Cage Net with | 140 | Danish Disposable Gloves | 176 | Dispenser, Aerosol | 274 |
| Colostrometer, Jorvet Equine | 353 | Cover, Lectro | 160 | Danish Knife | 104 | Dispenser, Alcohol | 115, 199 |
| Colostrum-Plus | 353 | Cover, Sterile X-ray Cassette | 327 | Debakey Forceps | 79 | Dispenser, Drape | 114, 201 |
| Columbia Curette | 339 | Cover, X-Ray Thyroid | 329 | Debakey Vascular Clamp | 84, 85 | Dispenser, Glove | 176 |
| Combs | 150-151 | Cover Glass | 319 | Deciduous Incisor Tooth | 350 | Dispenser, K-wire Storage | 99 |
| Combination Drill Tap & Insert | 241 | Covers, Instrument Clamp | 85 | Deciduous Incisor Tooth Extractor | 343, 350 | Dispenser, Paper Towel | 224 |
| Combine Dressing | 180 | Covers, Probe | 297 | Delhomer, Tube | 349 | Disposable Anesthesia Mask | 302 |
| Combine Roll | 114 | Cover Slips | 319 | Delmarva 2000 | 335 | Disposable Apron | 187 |
| Combo Ultrasonic Dental Unit | 336 | Cow Plastic Bailing Gun (Red) | 353 | Delta Style TPLD Plates (Precontoured) | 252 | Disposable Drape | 114 |
| Comfort Pak Warming Pad | 166 | Crate, Deluxe Double Door | 164 | Deluxe 1250 Bowie Electrosurgical Unit | 122 | Disposable Electrode | 121, 214 |
| Compact Dental Instrument Sterilization Cassette | 272 | Crile-Rankin Forceps | 79 | Deluxe Bone Toggle Kit | 266 | Disposable Feeding Needle | 66 |
| | | Crile Forceps | 79 | Deluxe Bowie Electrosurgical Unit | 215 | Disposable Food Tray Bowls | 167 |
| Complete Cold Therapy System | 132 | Crile Wood Needle Holder | 76 | Deluxe Double Door Crate | 164 | Disposable Lab Coat | 189 |
| Complete Infusion Set | 204 | Crimper, Compound Action | 262 | Deluxe Electrosurgical Ground Plate and Cord | 215 | Disposable Non-Sterile Surgeon Gown | 110, 187 |
| Complete IV Holder Track System | 208 | Crimp Tube | 259 | Deluxe IV Stand | 202 | Disposable Pen Light | 291 |
| Composite Dressing | 180 | Crimp Tube with Nylon Line | 259 | Deluxe Lectro-Kennel | 160 | Disposable Plastic Boots | 188, 371 |
| Compound Action Crimper | 262 | Cril-Carrier, Jorvet | 323 | Deluxe Microscope w/Plan Objectives | 265 | Disposable Plastic Cannulae | 242 |
| Compound Rongeur | 92 | Crossley Luxator | 339 | Deluxe Travel Carrier | 147 | Disposable Polystyrene Tube | 288 |

| | | | | | | | |
|---|---------------|--|----------|---|----------|------------------------------------|---------------|
| Boot, Walka | 160 | Burr-Kit, Rabbit | 342 | Carbide Float Blade | 351 | Catheter, Pezzar | 118 |
| Boots, Disposable Plastic | 188, 371 | Burton Lights | 213 | Carbon Dioxide Absorbent | 299 | Catheter, Plastic Urethral | 203 |
| Borer, Bone Tunnel | 101, 262 | Buster Aural Hematoma Pad | 136 | Carbon Fiber ESF Bars | 238 | Catheters, Equine | 369 |
| Bottle, Alcohol dispensing | 115 | Buster Clic Collar | 138 | Carbon Steel Surgical Blade | 74 | Catheter, Tom Cat | 117 |
| Bottle, Amber Dropper | 198 | Buster Comfort Mattress | 300 | Card, Microhematocrit Reader | 289 | Catheter, Urethral | 117 |
| Bottle, Spray | 198 | Buster Cube | 145 | Carmalt Forceps | 79 | Catheter and Instrument Tray | 127, 109, 211 |
| Bottle, Yorker Dropper | 200 | Buster Deluxe Vet Restraint Bag | 140 | Carpal Arthrodesis Plates | 250 | Cat Lax | 159 |
| Bouffant Cap | 112, 187 | Buster Dog Collar | 136 | Carpal Splints | 232 | Cat Nail Clipper | 156 |
| Bowie Digital Electrosurge Generator | 122, 215 | BUSTER Dog Socks | 166 | Carpo-Flex | 235 | Catnip Scratching Post | 143 |
| Bowie Electrosurgical Unit Stand | 215 | Buster ICU Cage | 300 | Carrier, 4-wheel Locking | 208 | Cavicide | 273 |
| Bovine Colostrometer | 353 | Buster Neck Brace | 137 | Carrier, Deluxe Travel | 147 | CCL Lateral Suture | 261 |
| Bovine Easy Drencher | 227 | Buster Nylon Basket Muzzle | 137 | Carrier, Pet | 148, 201 | CD/Rom, Cruciate Repair | 262 |
| Bovine Forceps | 79 | Butterfly Infusion Set | 203 | Car Seat Cover | 166 | Cell-WU Hemacytometer System Kit | 318 |
| Bovine Heavy-Duty Laryngoscope | 295 | C | | Cart, Evan's Mobility | 160 | Cell Counter | 321 |
| Bowl, Solution | 127, 212 | C-Fold, Paper Towel | 125, 224 | Cart, Medication & Utility | 220 | Centrifuges | 322 |
| Bowl, Sponge | 107, 127, 212 | Cabinets | 218, 219 | Cart, Treatment Procedure | 218 | Centrifuge Tube | 290, 323 |
| Bowls, Heavy Duty Stainless Steel | 210 | Cable Swine Snare | 101 | Cartridge, Cal-Gel® | 371 | Cerclage Wire | 98 |
| Bowls, Stainless Steel | 148 | Cadaver Bags | 201, 318 | Cartridge Dosing Gun | 371 | Cerclage Wire Passer | 264 |
| Bozeman Hemostat Forceps | 79 | Caddy, Roll-Around | 224 | Carts, Oxygen Cylinder/Tank Racks and | 303 | Cervical Collars | 136 |
| Brace, Buster Neck | 137 | Caesarian Forceps | 363 | Cassette, Chromic Gut Suture | 43 | CET Fingerbrush with Paste | 159 |
| Brace, Parson's Foal/Calf Flexor Tendon | 368 | Cage, Animal Restraint | 141 | Cassette, Compact Dental Instrument Sterilization | 272 | Chain, Bull Lead | 349 |
| Brace, Parson's Lower Leg | 368 | Cage, Banked | 223 | Cassette, NYLON Suture | 42 | Chain, Jorvet OB | 100 |
| Braun® & Jorvet Suture | 47 | Cages | 300 | Cassette, PGA Suture | 41 | Chain Eccrasseur | 354 |
| Braunamid, Pre-Cut | 44 | Cage, Multi Unit | 224 | Cassette, Quick Shot X-ray | 328 | Chamber, Anesthesia | 302 |
| Braunamid Cassette Suture | 44 | Cage, TTA | 257 | Cassette, X-ray | 329 | Chambers Catheter | 118 |
| Braun Manipler® AZ Suture Stapler | 49 | Cage Card Holder | 224, 334 | Cassettes, Biopsy Embedded | 133 | Chandler Elevator | 93 |
| Bravura Clipper | 154 | Cage IV Bag Holder | 208 | Cast, Jorvet Gel | 232 | Charger, Welch Allyn Desk | 282 |
| Breath, Jor-Vet Fresh | 302 | Cage Systems | 223 | Cast, Parson's Full Walking | 368 | Chart, Needle | 41, 45 |
| Breathing Bag | 303 | Cal-Gel® Cartridge | 371 | Cast Cutter | 101, 259 | Charts, Equine | 333 |
| Breed Specific Ear Trim Clamp | 85 | Calf Drencher | 132 | Cast Cutter Blades | 259 | Charts, Veterinary Anatomical | 332 |
| Broad Compression Plate 3.5 | 248 | Calf Nipple (with Cap) | 348 | Castile Soap Towellette | 274 | Chemtron Barb fitting | 304, 305 |
| Broad Plates 4.5mm | 250 | Calf Plastic Balling Gun (Blue) | 353 | Cast Padding | 230 | Chiba Style Biopsy Needle Unmarked | 69 |
| Broncho Alveolar Lavage Catheter | 118 | Calf Plastic Balling Gun w/grooved head (white)353 | | Castrator, Sands | 106 | Chiba Ultrasound Biopsy Needle | 69 |
| Brown Adson Forcep | 79 | Calf puller carry case | 352 | Castrojejo Caliper | 101 | Chisel, Bone | 93 |
| Brown Forceps | 78 | Caliper, Castrojejo | 101 | Castrojejo Eye Speculum | 96 | Chisel, Jorvet Bone | 268 |
| Brown Gauze Rolls | 173 | Caliper, X-ray Measuring | 329 | Castrojejo Fxation Forceps | 79 | Chisel, Percussion | 341, 359 |
| Brush, Closed Block Scrub | 115 | Camera, Minivid | 225 | Castrojejo Needle Holder | 76 | Chisel, U.S. Army Pattern | 93 |
| Brush, Combo Grooming | 152 | Camera, Trinocular scope w/Biovid | 286 | Castrojejo Scissors | 86 | Chisel Blade | 74 |
| Brush, Double Sided | 270 | Camera, USB | 225 | Cast Spreader | 101 | Chloraderm Shampoo | 158 |
| Brush, Endotracheal Tube Cleaning | 311 | Cancellous Screw | 239, 248 | Cat-Odor Off | 276 | Chlorhexidine and Zinc Oral Spray | 159 |
| Brush, Hand | 152 | Canine Catheter | 117 | Catche, Welbourn Cat | 140 | Chlorhexidine Solution | 128 |
| Brush, Insertion Coil and | 370 | Canine Elbow Model | 331 | Cat Claw Clipper | 156 | Chondrogen EO | 333 |
| Brushes | 152, 270 | Canine Gag | 338 | Cat Grasper | 140 | Christmas Tree Connector | 312 |
| Brush, Sterile Surgical Scrub | 116 | Canine Gastroscope | 295 | Cat Grass Plus | 146 | Chromic Gut Suture | 45 |
| Brush, Slicker Wire | 151 | Canine Hip/Lower Back Model | 331 | Cat Grooming Gloves | 152 | Chromic gut suture | 43 |
| Brush, Uterine Cytology | 324 | Canine Hip Model | 330 | Cathete, Silicone Acute Peritoneal Dialysis | 118 | Chromic Gut Suture Cassette | 43 |
| BSN Specialist Cast Padding | 180 | Canine Icer | 166 | Catheter & Instrument Tray, Covers | 211 | Chuck, Jacobs | 105, 258 |
| Back Ear Curette | 95 | Canine Internal Anatomy Chart (C) | 332 | Catheter & Instrument Tray | 211 | Chuck, Small Pin/Tap | 256 |
| Bucket, Stainless Steel Kick | 210 | Canine Models | 330, 331 | Catheter, Adapter Male Luer/Male | 118 | Circuit, Non-Rebreathing | 302 |
| Buff's Corkscrew Trocar | 266 | Canine Muscular Anatomy Chart (A) | 332 | Catheter, Bitch | 117 | Circuits, Anesthesia | 315 |
| Buffer, Jorvet Hoof | 366 | Canine Sidebars | 161 | Catheter, Broncho Alveolar Lavage | 118 | Circulating Warm Water Pump | 213 |
| Buffer Solution pH | 321 | Canine Skeletal Anatomy Chart (B) | 332 | Catheter, Canine | 117 | Citrus II Deodorizer | 276 |
| Buhner Needle | 133 | Canine Spay Pack | 107 | Catheter, Canine Urinary | 117 | Clamp | 85 |
| Bulb, Binocular Microscope Replacement | 284 | Canine Stifle Model | 331 | Catheter, Chambers | 118 | Clamp, Baby Doyen Intestinal | 84 |
| Bulb, Laryngoscope Replacement Light | 314 | Canine Tartar Scraper | 341 | Catheter, Dome | 101 | Clamp, Breed Specific Ear Trim | 85 |
| Bulb, Replacement Oscope | 280 | Canine Urinary Catheter | 117 | Catheter, Extended Use Polyurethane | 203, 369 | Clamp, Condyle | 84, 265 |
| Bulb, Visor Light Replacement | 290 | Canine Vaginoscope | 295 | Catheter, Female Luer to Male | 118 | Clamp, DeBakey Vascular | 84, 85 |
| Bulb, X-Ray Illuminator | 327 | Canister, Soda-Lime | 299 | Catheter, Foley | 117 | Clamp, Dual Pinch Tubing | 207 |
| Bulb, Laryngoscope Replacement Light | 279 | Canister, Stainless Steel Embossed Treat | 167 | Catheter, Foley Latex | 118 | Clamps | 85 |
| Bulb Syringe | 62 | Canister, Suction | 119 | Catheter, IV | 203 | Clamp, Jorvet KE Plus | 256 |
| Bull Lead | 349 | Cannula, Irrigating | 123, 364 | Catheter, Jackson Cat | 118 | Clamp, Jorvet Small Lowman Bone | 268 |
| Bull Ring | 349 | Cannula, Plastic Sterile Test Infusion | 365 | Catheter, Jorvet Large Animal IV | 203, 369 | Clamp, Jorvet Split KE | 256 |
| Bull Semen Collection Cones | 334 | Cannula, Udder Infusion | 364 | Catheter, Jorvet Oxygen | 313 | Clamp, Linear Hook on | 239 |
| Burner, Portable Bunson | 321 | Cannulae, Disposable Plastic | 242 | Catheter, Jorvet Suction | 118 | Clamp, Micro Tooth Meniscus | 85, 263 |
| Burr, Diamond Dental | 342 | Cap, Bouffant, Surgeon | 112, 187 | Catheter, Malecot | 117 | Clamp, Nylon Towel | 82 |
| Burr, Strawberry Roaring | 103 | Cap, Injection | 202 | Catheter, Mare | 369 | Clamp, Small Lowman Bone | 103 |
| Burr, Taper Side Cut | 342 | Cap, Syringe | 62 | | | Clamp, Tensioning | 262 |
| Burr, X-long Cross Cut | 336 | Capillary Sealant Tray | 326 | | | Clamp, X-Small Serrated Bone | 85 |

| | | | | | | | |
|--|----------|-------------------------------------|----------|--|----------|--|----------|
| Symbols | | Aluminum Hub Needles | 66 | Bag, Buster Deluxe Vet Restraint | 140 | Bishop-Harmon Forceps | 78 |
| 0.9% Sodium Chloride Injection | 205 | Amber Dropper Bottle | 198 | Bag, Cadaver | 201 | Bit, Bone Drill | 243 |
| 10%, Potassium Hydroxide | 320 | Amber Plastic Graduated Ovals | 198 | Bag, Mesh Cat Restraint | 140 | Bitch Catheter | 117 |
| 100X Phase Contrast Kit | 285 | Amber Prescription Safety Cap Vials | 198 | Bag, Resuscitation | 303 | Bits, Orthopedic Drill Case w/9 Drill | 243 |
| 10 Instrument Pack | 108 | Ameriod Constrictors | 109 | Bag, Urine Collection | 134 | Bitter Rid Spray | 159 |
| 10X Phase Contrast Kit | 285 | Anal Sac Excision Kit | 128 | Bag, Urine Drainage | 134 | Blade, Carbide Float | 351 |
| 14 Instrument Pack | 108 | Anesthesia, Wall Mount | 298 | Bag, with Attached Transfer | 205 | Blade, Carbon Steel Surgical | 74 |
| 3-Way, Stopcock | 202 | Anesthesia Breathing Tube | 302 | Bags, Biohazard | 201 | Blade, Chisel | 74 |
| 3M Fiberglass Casting Tape | 230 | Anesthesia Chamber | 302 | Bags, Biohazard Disposal | 201 | Blade, Equivet Carbide Magnetic Float | 345, 351 |
| 7-day Pill Case | 200 | Anesthesia Circuits | 315 | Bags, Cadaver | 201, 318 | Blade, Hoof | 104 |
| 7 Instrument Pack | 108 | Anesthesia Elbow Connector | 312 | Bags, Doggie Doo | 147 | Blade, Hug's | 104 |
| | | Anesthesia Hose Adaptor 2/pk | 312 | Bags, Nylon Feline Restraint | 140 | Blade, Carbide Float | 345 |
| A | | Anesthesia Hose Connector/Dual | 312 | Balfour Retractor | 96 | Blade, Test | 104 |
| "Ade" Leader Line Configurations | 259 | Anesthesia Machine | 298 | Balling Gun | 101 | Blade, McIntosh Laryngoscope | 279, 314 |
| Abdominal (Combine) Pad | 180 | Anesthesia Mask and | 302 | Balls, Jorvet Absorbent Cotton | 173 | Blade, Miller Laryngoscope | 314 |
| Absorbent, Carbon Dioxide | 299 | Anesthesia Scavenging Hose | 302 | Balls, Non-Sterile Cotton | 124, 173 | Blade, Mini | 74 |
| AbsorbENT™ Ear Wick | 128 | Anesthesia Unit | 298 | Bandage, Ace Elastic Compression | 181 | Blade-Safe Surgical Blade Remover | 75 |
| Absorbent Wound Pads | 181 | Anesthetic, Isoflurane Inhalant | 299, 301 | Bandage, Elastic Adhesive | 178 | Blades | 155 |
| AccuJack Ejaculator | 347 | Angelica Angelstat® Scrubs | 182 | Bandage, Gauze | 171 | Blades, Cast Cutter | 259 |
| Ace Bandage w/self Close Velcro | 181 | Angelstat® Scrubs | 182 | Bandage, Fluff Dressing | 171 | Blades, Jorvet-Aesculap Saw | 105, 258 |
| Ace Elastic Compression Bandage | 181 | Angled Tooth Fragment Forcep | 343 | Bandage, Gauze Roll | 172 | Blades, Laryngoscope Handles and | 314 |
| Acetabular Bone Plates | 250 | Animal Gauntlet Gloves | 177 | Bandage, Self Adherent | 171 | Blades, Micro Scalpel | 74 |
| Acid Fast Stain | 320 | Animal Lead | 142 | Bandage, Test | 364 | Blades, Mini | 74 |
| Acrylic Blood Tube Rack | 316 | Animal Restraint Cage | 141 | Bandage/Tourniquet, Jorvet Esmark | 181 | Blades, Modular Osteotome | 94 |
| Acrylic Exam Glove Dispenser | 176 | Animal Stretcher | 213 | Bandage Scissors | 86 | Blades, Scalpel | 127 |
| ACT Drape | 114 | Anti-kick Bar | 297 | Banked Cage | 223 | Blades, Stainless Steel Surgical | 74 |
| Adapter, Dual Male | 207 | Anti-Skid Drill Bits | 243 | Barbed Connector | 207 | Blades, Sterile Swann-Morton Scalpel | 276 |
| Adapter, Endo | 117 | Anti-Vibration Mat | 322 | Barbed Oxygen Connector | 303 | Blades, Test | 364 |
| Adapter, Endotracheal Tube | 311 | Anti Kick Device | 297 | Barn's Dehorer | 349 | Blades, Laryngoscope | 314 |
| Adapter, Injection | 207 | Antiseptic, Hand | 274 | Barraquer Eyelid Speculum | 96 | Blanket, Disposable Warming | 128 |
| Adapter, Male Luerlock | 207 | Antiseptic Hand Gel | 274 | Barraquer Retractor | 96 | Blanket, Plastipad Urethane | 226 |
| Adapter, Power Drill | 258 | Antiseptic Towelette | 274 | Barrel Spring Nail Nipper | 90 | Blanket, Thermal Reflective | 127 |
| Adapter, Ultrasite IV | 207 | Anvil Nail Splitting Forceps | 90 | Bars, Carbon Fiber ESF | 238 | Blankets, Maxitherm Vinyl | 226 |
| Adapter, Universal Bottle | 334 | ACE Deodorizing Wipes | 276 | Base Stool Blue Vinyl w/Black base | 218 | Bleeding Needle | 370 |
| Adapters, Wye | 305 | Applicator, ELD Gastrostomy Tube | 130 | Basin, Emesis | 127, 212 | Block, Dental Burr | 342 |
| Adaptor, Needle Free Multi Dose Vial | 207 | Applicator, Lab Eartag | 318 | Battery, Alkaline | 289 | Block, Rubber | 360 |
| Adaptor, Orthopedic Drill | 105 | Applicator, Silver Nitrate | 123 | Battery, Rechargeable | 279 | Blocks, Jorvet Equine Hoof Positioning | 361 |
| Adhesive, Oasis Liquivet Tissue | 50 | Applicator, Surgical Scrub | 116 | Battery, Welch Allyn 3.5v Rechargeable | 282 | Blood Bag | 205 |
| Adhesive, Silicone | 363 | Applicators, Cotton-Tipped | 124 | Baumgartner Needle Holder | 76 | Blood Collection | 205, 316 |
| Adhesive, Tissue | 50 | Applicator Sticks | 124 | Bayer Mouth Wedge | 360 | Blood Collection Needle | 61 |
| Adhesive Bandages | 181 | Apron, All Purpose | 161 | Beaker, Jorvet 3 Corner | 317 | Blue, Lactophenol Cotton | 320 |
| Adhesive Drape w/Povidine | 113 | Apron, Disposable | 187 | Beasley Babcock forceps | 78 | Blue Vials (Safety Cap Vials) | 198 |
| Adhesive Surgical Drape w/Povidine | 114 | Apron, Rubberized CB | 371 | Bed, Country Dreams | 166 | Blunt End Needle | 69, 70 |
| Adjustable Splint | 233 | Aprons, Jorvet Disposable | 187 | Bed, Fleece | 166 | Bodysuit, VetMed Care Protective | 163 |
| Adson Dressing Forceps | 78 | Aprons, X-Ray | 329 | Beeson Cast Spreader | 259 | Bone Cement | 255 |
| Adson Tissue Forceps | 78 | Arco Clipper | 154 | Behney Ear Instrument | 100 | Bone Chisel | 93 |
| Aerosol Deodorizer | 274 | Aspir-Gun | 297 | Belly Buddies Dog Toy | 145 | Bone Drill Bit | 243 |
| Aerosol Dispenser | 274 | Aspiration Suction Unit | 119, 229 | Bender, K-Wire | 99 | Bone Fragment Forceps | 91 |
| Aesculap Mayo Hegar Needle Holder | 76 | Aurora Surgical Gown | 111 | Bennett Cilia Forceps | 79 | Bone Holding Forcep | 91, 265 |
| Aesculap Mayo Scissors | 86 | Auspex Avian Restraint | 133 | Beyer Rongeur | 92 | Bone Marrow Biopsy/Aspiration | 69 |
| Aesculap Metzenbaum Scissors | 86 | Autoclavable Cases | 264 | Billeau Ear Curette | 95 | Bone Pin Counter Punch | 260 |
| Aesculap Olsen Hegar Needle Holder | 76 | Avian Adhesive Drape | 133 | Binocular LabScope | 285 | Bone Plate Benders | 266 |
| Aesculap Pneumatic Sytem for TPL0 | 258 | Avian Plexiglass Collar | 137 | Binocular LabScope w/Pfan | 285 | Bone Plate Clip | 252 |
| Agar Gel Transport Swab | 325 | Avian Positioner | 133 | Binocular Microscope | 284, 285 | Bone Plate Holding Forceps | 91, 265 |
| AI Pipettes | 334 | B | | Biocam 2.0 Video Otoscope | 294 | Bone Plate Press | 253 |
| Airbag, Warming | 128 | "Bos" Lower Leg Splint | 353 | BioHazard Bags | 201 | Bone Rongeur | 92 |
| AKC Companion Animal Recovery Microchips | 126 | B-D Luer-Lock Tip Syringe | 60 | Biological Healing Plates | 252 | Bones, Nutrient | 146 |
| Alarm, Audio-visual | 299 | B-D Needles | 60 | Biopsy/Aspiration, Bone Marrow | 69 | Bone Saw | 101 |
| Alcohol, Isopropyl | 115 | B-D Syringe | 60 | Biopsy Embedded Cassettes | 133 | Bone Screw and Drill Bit Gauge | 258 |
| Alcohol Dispenser | 115, 199 | Babcock Forceps | 78 | Biopsy Needles | 68 | Bone Screw Rack | 245, 264 |
| Alcohol dispensing bottle | 115 | Baby Balfour Retractor | 96 | Biotene Antiseptic Oral Gel | 159 | Bone Scriber | 266 |
| Alcohol Prep Pads | 115 | Baby Doyen Intestinal Clamp | 84 | Biotene Maintenance Kit | 159 | Bone Toggle | 266 |
| Alligator Forceps | 78 | Baby Kerns Bone Forceps | 91, 265 | Bipolar converter | 214 | Bone Tunnel Borer | 101, 262 |
| Allis Tissue Forceps | 78 | Baby Mixer Forceps | 78 | Bipolar Footswitch | 215 | Bone Washer | 264 |
| All Purpose Apron | 161 | Baby Ribbon Retractor | 97 | Bird Collar | 137 | Bone Wax | 50, 264 |
| All Purpose Wet Table | 221 | Backhaus Towel Clamp | 84 | Bird Leg Ring Cutter | 144 | Booklet, Fetotomy Procedure | 370 |
| Alm Retractor Sharp | 96 | Backhaus Towel Clamps | 84 | Bird Nail & Feather Trimmer | 144 | Boot, Technovit Cow | 362 |
| Alcotouch® Exam Gloves | 175 | Bacterial/Viral Filter | 312 | Bird Toy Crown | 144 | Boot, Unna's | 181 |

| | | | | | | | |
|--|----------|-------------------------------------|---------------|--|----------|--|---------------|
| Disposable Scalpel | 127 | Drencher, Jorvet Bow-Vet Calf | 348 | Elevator, Wolf Tooth | 352 | EquiVet Dental Mirror | 345, 350 |
| Disposable Scalpel | 75 | Drencher, Jorvet Oral Calf | 348 | Elevator, Wolftooth | 359 | EquiVet Dental Pick | 344, 352 |
| Disposable Stainless Steel Scalpels | 75 | Drench Pump | 123, 349 | Elevator Set | 340 | EquiVet Dental Rasps Protector | 350 |
| Disposable Surgery Gown | 110 | Dressing, Combine | 180 | Elite Floor Standing Electronic Scale (E) | 292 | EquiVet Magnet Floats | 346, 351 |
| Disposable Surgical Drape SMS | 114 | Dressing, Composite | 180 | Emascutome | 358 | EquiVet Mouth Wedge | 360 |
| Disposable Surgical Drape Sontara | 113 | Dressing, Jorvet Transparent | 180 | Emasculators | 106, 358 | EquiVet Parallel Gingival Elevator | 352 |
| Disposable Syringes & Needles | 54 | Dressing, Jorvet X-span Tubular | 181 | Embroidery | 184 | EquiVet Polyurethane Stomach | 130 |
| Disposable Warming Blanket | 128 | Dressing, Non-Adherent | 180 | Embryotomy Knife | 101 | EquiVet Pony Size Mouth Wedge | 360 |
| Disposable Water and Food Bowls | 167 | Dressing Jar | 107, 127, 212 | Emesis Basin | 127, 212 | Esophageal Foreign Body Forceps | 80, 265 |
| DISS, Dial Flowmeter w/Female DISS & Male | 307 | Drill, Makita Orthopedic | 105, 258 | Emmett Uterine Tenaculum Hook | 101 | Esophageal Stethoscope | 131 |
| DISS fitting Barbed end | 304 | Drill Guide and Insert | 256 | Enclosed Bone Pin Cutter | 103, 241 | Esophagostomy Tube | 315 |
| Distal Femur Plate | 251 | Drill Shroud (Autoclavable) | 105 | End Cap for IV Track | 208 | Esophagostomy Tube Insertion Device | 130 |
| Distractor, Orthopedic | 102, 268 | Drinkwater Mouth Gag | 359 | End Cap for vaporizer Male - Female | 299 | Esophagostomy Tube Replacement | 131 |
| Divider, Oxygen | 312 | Driver, Heavy-Duty Needle | 262 | Endo Adapter | 117 | Ethilon® Suture | 45 |
| Docker, Tail | 103 | Driver, TTA 2.4 Cross Head Screw | 257 | Endolight | 311 | Evacuators, Silicone Bulb | 132 |
| Dog-Odor Off | 276 | Dropper, Glass Eye | 198 | Endolight, Jorvet | 291 | Evan's Mobility Cart | 160 |
| Doggie Doo Bags | 147 | Dropper, Plastic Medicine | 198 | Endoscope | 225, 227 | Ewe Prolapse Retainer | 131 |
| DogLeggs Chest Strap | 236 | Dual Head Stethoscope | 277 | Endotracheal Tube | 308-311 | Exam Glove Box Holder | 176 |
| Dogs, Nail Trimmer for | 156 | Dual Male Adapter | 207 | Enema or Oral Calf Feeder Bag | 349 | Exam Penlight | 125 |
| Dome Catheter | 101 | Dual Pinch Tubing Clamp | 207 | Enema Solution 4.5 Oz | 125 | Exam Table | 220 |
| Doppler, Headset for | 289 | Dual Tank Manifold | 306 | Engel Cast Cutter | 259 | Exam Table Paper | 127 |
| Doppler BP Cuff 1.9cm | 289 | Duck-Billed Mini-Rongeur | 263 | Enteral Feeding Products | 129 | Exchanger, Humidification Management | 312 |
| Doppler Cuff | 289 | Duck-Billed Mini Rongeur | 92 | Envelope, Sterilization | 269 | Excision Rasp | 94 |
| Doppler Sphygmomanometer | 289 | Dura Slick II Electrodes | 293 | Enzymatic Instrument Cleaner | 271 | Exel 3cc Syringe with Needle | 59 |
| Doppler Ultrasonic Blood Flow Monitor | 289 | Dynamic External Fixator Kit | 237, 238 | Epoxy ESF Putty | 255 | Exotic/Small Animal | 302 |
| Dose Adaptor | 318 | E | | Equine Dental Compound Rongeur | 267 | Explorer/Measuring Probe | 341 |
| Double-Curved Suture Needleless | 50 | E-Z Lift | 226 | Equalizer, GasVak™ Atmospheric | 216 | Explorers/Probes | 339 |
| Double Christmas Tree Connector | 207 | E-Z Nail Clipper and Filer | 153 | Equine "Army Surplus" Brown Leg Wrap | 361 | Extended Use Polyurethane Catheter | 203, 369 |
| Double Diners | 210 | Ear-Ulcer Syringe | 62 | Equine Chain Twitch | 347 | Extension Set | 206 |
| Double Door Double Lock | 219 | Ear Clamp | 85 | Equine Charts | 333 | External Fixation | 237-238 |
| Double Ended Curette | 95 | Ear Cleaner | 162 | Equine Dental | 92 | Extracting Forceps | 80 |
| Double Ended Disposable Ear Currettes | 95 | Ear Cropping Scissors | 86 | Equine Dental Fulcrum | 350 | Extraction Alligator Forceps | 78 |
| Double Ended Subgingival Curette | 339 | Ear Mite Killer | 162 | Equine Dental Instruments | 344, 352 | Extraction | 343, 350, 352 |
| Double End Elevator 4mm | 352 | Ear Model | 330 | Equine Endotracheal Tube | 363 | Extractor, Jorvet Rodent Molar | 337 |
| Double End Transfer Needle | 70 | Ear Syringe | 62 | Equine Express Semen Transport Case | 347 | Extractor, Probing with | 348 |
| Double Loop Cerclage Wire Tightener | 98, 263 | Eartags, Lab | 318 | Equine Eye Lid Speculum | 347 | Extractor, Reynold's Equine Tooth | 342, 350 |
| Double Post Mayo Stan | 211 | ECG Machine | 293 | Equine Full Mouth Speculum | 360 | Extractor, Test Tumor | 364 |
| Double Post Mayo Stand | 211 | Echogenic Enhanced Tip (Ultrasound) | 69 | Equine GasVak System | 216 | Eye, Crystal | 158 |
| Double Sided Brush | 270 | Ecklin-Duckbill Rongeur | 92, 263 | Equine Molar Cutter | 345 | Eye, Graft Passer with Small | 102, 262, 263 |
| Double Spring Nail Nipper | 90 | Eclipse Surgical Gown | 111 | Equine Molar Forcep | 345, 350 | Eye Dressing Forceps | 80 |
| Doyen Forceps | 79 | Economy Calf Puller | 352 | Equine Nylon Rope Twitch | 362 | Eyelet, Cerclage Wire | 98 |
| Dr. Irvin's Sharflow | 364 | Economy Collar | 135 | Equine Padded Recovery Hood | 354 | Eyelid Retractor | 96 |
| Dr. Kenney Stallion Semen Ext. (w/antibiotics) | 347 | Economy IV Stand with 2 Hooks | 202 | Equine Platform Weighing Scale | 222 | Eye Pad | 179 |
| Dr. Larsen's tm Teat Tube | 364 | Ecrasseur, Chain | 354 | Equine Semen Extender (w/Antibiotics) | 347 | Eye Piece W/ Pointe | 285 |
| Dräger Isoflurane Vaporizer | 299 | Extractor, Saalfeld Comedone | 94 | Equine Shoe Puller/Spreader | 91 | Eyesaver™ Eye Patch | 361 |
| Dräger Sevoflurane Vaporizer | 299 | Ecosaderm | 159 | Equine Silicon Endotracheal Tube | 310 | F | |
| Drain, Flexi-drain Multi-Purpose Wound | 131 | Ejaculator, AccuJack | 347 | Equine Silicon Tracheostomy Tube | 363 | Facial Tissue | 115 |
| Drain, Penrose | 116 | Ejay Haylo | 165 | Equine Sinus Trephine | 345, 359 | Facial-Ova Float | 288 |
| Drain, Silicone Thoracic | 134 | Elastic Bandage | 178 | Equine Speculum Dental Light | 352 | Fecal Loop | 123, 297 |
| Drain, Silicone Wound | 133 | Elastikon® Tape | 179 | Equine Universal Dental | 350 | Fecal Specimen Container with Spoon | 200 |
| Drape, ACT | 114 | Elbow Glove | 176 | Equine Universal Dental Extraction Forceps | 345 | Fecatector Diagnostic Kit | 288, 326 |
| Drape, Avian Adhesive | 133 | ELD Gastrostomy Tube Applicator | 130 | Equine Uterine Bopsy Instrument | 106 | Fecatector Dignostic Kit | 288 |
| Drape, Disposable | 114 | Electrode, Electrosurgical Unit | 121, 214 | Equine Uterine Infusion Pipette w/adaptor | 348 | Feeder, Oral Calf | 348 |
| Drape, Fenestrated | 113 | Electrode, pH Replacement | 321 | Equine Uterine Lavage "Y" Catheter | 369 | Feeding, Needles | 66 |
| Drape, Impervious | 113 | Electrode, Reusable | 214 | Equine Uterine Lavage Administration Kits | 365 | Feeding/Stomach Tubes | 129 |
| Drape, Sontara | 114 | Electrode Autoclavable 1/16" | 121 | Equine Vectra® Genisys Laser System | 228 | Feeding Needle | 370 |
| Drape, Sterile Surgical | 114 | Electrode Loop | 215 | Equipmt, Stainless Steel Case for TTA | 257 | Feeding Syringe | 62 |
| Drape, Veterinary Surgical | 113 | Electrodes, Dura Slick II | 293 | Equipment, 2.7mm Cortical Screw and | 247 | Feeding Tube | 130 |
| Drape Dispenser | 114, 201 | Electrodes, Reusable | 121 | Equipment, 4.5mm Cortical Screw and | 249 | Felchenfeld Splinter Forceps | 80 |
| Drapes, Leg | 112 | Electrodes, Televet ECG | 293 | Equipment, Box & Silicone Insert for TTA | 257 | Feline Breathe Easy Inhalant Delivery System | 229 |
| Drapes, Sterile Surgical | 113 | Electrode Storage Solution | 321 | Equiprux X-ray Positioner | 328 | Feline Breathe Easy Inhalant Delivery System | 313 |
| Drapes, Sterile Veterinary Surgical | 113 | Electronic Pet Scale | 292 | EquiVet Cap Forceps | 350 | Feline Declaw Forceps | 80 |
| Drawer, with Cabinet and | 221 | Electrosurgical Unit | 121, 214 | EquiVet Cap Forceps w/Flexible Head | 345 | Feline Dental Extractor | 343 |
| Drencher | 348 | Elevator | 340 | EquiVet Carbide Magnetic Float Blade | 345, 351 | Feline Gag | 338 |
| Drencher (Barrel only) | 348 | Elevator, EquiVet Parallel Gingival | 352 | EquiVet Cervical Forcep | 358 | Feline Skeletal Anatomy Chart (D) | 332 |
| Drencher (O Ring Only) | 348 | Elevator, Freer | 93, 267 | EquiVet Cheek Retractor | 345, 360 | Feline Skeletal Model | 330 |
| Drencher, Bovine Easy | 227 | Elevator, Gingival | 344 | EquiVet Dental Halter | 360 | Feline Spay Pack | 107 |
| Drencher, Calf | 132 | Elevator, Periosteal | 93, 267 | EquiVet Dental Irrigation Pick | 350 | Feline Urethral | 117 |

- Felway 162
Female Luer to Male Catheter 118
Femoral Disarticulator 101
Fenestrated Drape 113
Feral Cat Den 165
Ferguson Angiotribe Forceps 80
Ferguson Stone Scoop 95
Ferromatic Automatic Syringe 63, 355
Fessa Tubular Fixator System 241
Fetal Extractor 352
Fetotome Case 370
Fetotomy Procedure Booklet 370
File, Nail 153
Files, Dental 339
Filter, 0.2 Micron 320
Filter, Bacterial/Viral 312
Filter, X-Ray Density 329
Filters, Con-Trade © Fecal 288
Fine, Gillies Retractor 96
Finger Ring Cutter 109
Finocchio Rib Spreader 102
Fits, Protect-A-Pad Cover 226
Fitting, Attached to Male Barbed 202
Fittings, Oxygen 305
Fixation, External 237
Fixation Pins 238, 260
Flat Closed Probe 217
Flat Float Blade (Tungsten Carbide) 346, 351
Flea Comb 150
Fleam, Pet 150
Flea Life-Cycle Model 333
Fleece Bed 166
Flexi-Drain Multi-Purpose Wound Drain 131
Flexible Endoscope Complete 225
Fleximount Wall Mount Kit 213
Float 346, 351
Floor Squeegees 273
Flowmeter, Jorvet 216
Flowmeters, Oxygen Regulators 307
Fluid Resistant Isolation Gowns 111, 187
Fluids, Normosol-R IV 205
Flush Valve 312
Flux Rumen Infusion Pump 348
Foil Nasotracheal Tube 363
Foaming Autoclave Cleaner 270
Folding Scalpel Handle 74
Foley Catheter 117, 118
Fomon Rasp 94
Foot-Rot Hoof Shears 366
Footswitch, Bipolar 215
Forbid 159
Forceps 78-84, 90-91, 106, 265, 343, 350
Forcep, Equivet Cervical 358
Forcep, Wolftooth Extractor 343, 359
Forceps, Caesarian 363
Forceps, Cruciate Repair Crimping 259
Forceps, Equine Universal Dental Extraction 345
Forceps, K-Wire Extraction 99
Forceps, Liston Bone Cutting 91, 267
Forceps, Pin Removal 103, 241
Forceps, Plastic 321, 326
Forceps, Protection Tube for Uterine Biopsy 131
Forceps, Reusable Bipolar 121, 214
Forceps, Rigid Biopsy 225
Forceps, Stille Liston Bone Cutting 268
Forceps Jar 127, 212
Forester 80
Formalin-Filled Container 326
Four Paws Cologne 158
Four Paws Instant Dry Shampoo & Deodorant 158
Four Paws Nite-Brite Reflective Leash 142
Four Root Dental Extraction Forceps 343
Fox Dermal Curette 95
Franks Emasculator 106
Franseen Style Biopsy Needle 68
Freeman Cage Net with Cover 140
Free Martin Probe 367
Freer Elevator 93, 267
Fulcrum, Equine Dental 350
Fulcrum, Jorvet Equine Dental 344
Full Length Lab Coat 189
Full Length Tail Lab Coat 189
Furminator 152
Fuse, Binocular Microscope 284
G
Gag, Canine 338
Gag, Drinkwater Mouth 359
Gag, Feline 338
Gag, Jorvet Equine Incisor 361
Gag, Jorvet Lightweight Rodent Mouth 337
Gag, Lightweight Rodent Mouth 105
Gag, McPherson Mouth 360
Gags 105, 337-338
Gas Hose Assembly 304
Gastroscope, Canine 295
GasVak™ 216
Gauge, Bone Screw and Drill Bit 258
Gauge, Depth 260
Gauge, Jorvet Orthopedic Punched Hole 258
Gauge, Slocum/TPL0 Rotation 103, 254
Gauntlet Gloves 177
Gauze 171-173, 180
Gauze, Tube 122
Gaymar Blanket/Pump Connectors 226
Gel, Antiseptic Hand 274
Gel, Biotene Antiseptic Oral 159
Gel, Dentacetic 160
Gel, Enzymatic Instrument Pre-Cleaner 271
Gel, Ultrasound 290
Gel, Yuk-2e Anti-Lick 159
Gel Foam Cushion 220
Gelpi Retractor 96
General Surgery Pack 108
Generator, Electrosurgical 122, 215
Gerlach Needle 133
German Scissors 86
German Instrument Packs 109
Germicidal Disinfectant Detergent 273
Germicide, Pink 270, 342
Gerzog Mallet 102, 268
Gigli Saw 99
Gillies Retractor Fine 96
Gingival Elevator 344
Glass Eye Dropper 198
Glass Sundry Jars 199
Gleamer Floorstand Light 213
Gloves 173-177
Gloves, Cat Grooming 152
Gloves, X-Ray 329
Glutaraldehyde Cold 273
Goggles 112
Goniometer 260
Gowns 110-111, 186-187
Graduated Measures Cup 127, 212
Graefe's Eye Speculum 102, 347
Graefe Iris Forceps 80
Graft Passer with Small Eye 102, 262, 263
Grasper, Cat 140
Grates, Multi Unit Cage Floor 224
Graves 102
Greenies 146
Greyhound-Style Pet Combs 150
Groom-Aid Spray 157
Grooming Gloves 177
Grooming Moose 157
Grooming Table 157
Grooved Probe Director 102
Groover, Hughes Hoof 366
Groover, Hughes Hoof 104
Guard, IV Catheter 203
Guards, Retractor 97
Guards, Surgical Instrument 108, 256
Guide, Adjustable Drill 260
Guide, Instrument Care & Protection 72
Guide, Jorvet OB Wire 99
Guide, Load/Neutral Drill 260
Guide, Locking Screw Drill 253
Guide, OB Wire 353
Guide, TTA Drill 257
Guillotine Style Nail Trimmer 156
Gun, Cartridge Dosing 371
Gun, Jorvet LePill Balling 353
Gun, Jorvet Multi-dose Balling 353
Gumey 220
H
Hair Strainer & Trap 157, 221
Haler, Jorvet Equine 361
Halls Anesthesia Mask 302
Halogen Lamp 283
Halogen Light 213
Halogen Penlight 120, 291
Halothane Anti-Spill 299
Halpa Fleece Liner 234
Halsey Needle Holder 76
Halsted Mosquito Forceps 80
Halter, Equivet Dental 360
Halti Harness 142
Halti Head Collar 141
Hammer, Taylor 103, 126
Hand Antiseptic 274
Handbook, Cryosurgery in Horses 333
Hand Brush 152
Hand Held Tally Counter 321
Handle, Folding Scalpel 74
Handle, Integra/Millex Dental Mirror 341
Handle, Jorvet Ob Wire 99
Handle, Jorvet Prod Extension 349
Handle, Jorvet T-bar OB 100
Handle, Laryngoscope 279, 314
Handle, Lyss OB 99
Handle, Pincutter with Breakdown 103, 241
Handle, Plastic Scalpel 74
Handle, Poole Suction 119
Handle, Quick Release Tap 256
Handle, Rechargeable 281
Handle, Stainless Steel Pails With 210
Handle, Strap 211
Handle, Yankauer 119
Handles, Gigli Saw 99
Handles, OB Chain 100
Handles, Scalpel 74
Handpiece Cord 336
Handy Tech Pet Parking System 296
Hanger, X-Ray Developing 329
Hanging Cat Scratcher and Toy 145
Hanging Scale 292
Harr's Bull Lead 349
Harness 142
Harness, The Walkabout™ 164
Harness, Web Master 160
Harrington Retractor 96
Hartman Alligator Forceps 78
Hatt Spoon Curette 267
Hauptman OHE Retractor 96
Hauptner Clipper 349
Hauptner OB wire 99
Hauptner Syringe & Parts 64, 356
Haylo, Ejay 165
Headset for Doppler 289
Heaney Retractor 96
Heart Model 331
Heartworm Disease Model 330
Heartworm Rack 316
Heavy-Duty, Round-Hole Plate 3.5mm 245
Heavy-Duty Needle Driver 262
Heavy Calculus/Tarter Removal Forceps 343
Heavy Duty Nail Trimmer 156
Heavy Duty Stainless Steel Bowls 210
Heavy Duty Suture-Needles Half Curved 50
Heavy Duty Suture Needleless 51
Hemocytometer, Neubauer 318
Hema Stop Styptic Powder 233
Hemo Mate Blood Filtration System 296
Hemo Tap Filter Spike 296
Henke Drench-Matic 65, 357
Hernia Clamp 85
Hesperan Bag 205
Hog Holder with Lock 363
Hohman Retractor 96, 263
Hone, Jorvet Hoof Knife 104
Hood, Equine Padded Recovery 354
Hoof Blade 104
Hoof Crease Nail Puller 90, 104
Hoof Knife 366
Hoof nipper or trimmer 90
Hoof Pick 104
Hoof Tester 366
Hoof Trimmer 366
Hook, Emmett Uterine Tenaculum 101
Hook, Krey 353
Hook, OB Double Eye 353
Hook, Ostertag Blunt Eye 353
Hook, Spay 97
Hook, Stationary IV Ceiling 208
Hook, Vienna Double OB 365
Horasley's Trephine 345
Hose, Anesthesia Scavenging 302
Hose, Oxygen 304
Hose, Pet Bath 157, 221
Hose, Suction 119
Hose End Sprayer 273
House Combination Dental Float 346
House Curette 267
Hub, Aluminum 70
Hug's Blade 104
Hughes Hoof Groover 104, 366
Humidifier, Jorvet 313
Humidification Management Exchanger 312
Huston Umbilical Clamp 85
Hydrometer for Fecal Flotation Solutions 326
Hypodermic Needles 67, 70

| | | | | | |
|---|----------|---|-------------------------|--|----------|
| I | | J | | | |
| ID-Band | 165 | J-Lube Powder | 125 | Jorvet Drill Shroud | 258 |
| Ideix Snap Test | 296 | Jackson-Chevalier Biopsy Forcep | 106 | JorVet Dual Head Stethoscope | 277 |
| Illuminator | 283 | Jackson Cat Catheter | 118 | Jorvet Emasculator Instrument Aid | 358 |
| Illuminator, Metal Halide | 227 | Jacobs Pin Chuck | 105 | Jorvet Endolight | 291 |
| Illuminator, X-Ray | 327 | Jacquette Scaler | 341 | Jorvet Equine Colostrometer | 353 |
| IM Bone Pin Protective Tube | 240 | Jar | 107, 127, 199, 212, 320 | Jorvet Equine Condom | 358 |
| Immersion Oil | 318 | Jelly, Lubricating | 125 | Jorvet Equine Dental Fulcrum | 344 |
| Impervious Drape | 113 | Jet, Jorvet Squeeze | 354 | Jorvet Equine Haler | 361 |
| IM Pin Kit, Bag | 240 | Jewellers Forceps | 81 | Jorvet Equine Hoof Positioning Blocks | 361 |
| Incubator | 324 | Jones Artery Forcep | 80 | Jorvet Equine Incisor Gag | 361 |
| Indirect Viewing Lens | 282, 283 | Jones Towel Clamp | 85 | Jorvet Equine Leg Wrap | 181, 362 |
| Infinity LabScope | 285 | Jorgensen, Nylon Syringe | 62 | Jorvet Esmark Bandage/Tourniquet | 181 |
| Infusible Pressure Infusor | 204 | Jorgensen Osteotome | 93, 268 | Jorvet Even Crush Emasculator | 358 |
| Infusor, Spring | 207 | Jorvet Aluminum Hub Needles | 66 | Jorvet Extension Piece for 2nd Vaporizer | 301 |
| invid 8.1 Megapixel | 225 | Jorvet Aesculap Saw Blades | 105, 258 | Jorvet External Fixation | 237 |
| Injection, 0.9% Sodium Chloride | 205 | Jorvet 2.4mm Compression Plate | 247 | Jorvet Extra Large Bone Plate Press | 253 |
| Injection Adapter | 207 | Jorvet 2.7mm Cortical Self Tapping Screws | 239 | JorVet Eye Shields | 112 |
| Injection Cap | 202 | Jorvet 3-way Stopcock | 202 | JorVet Face Shield | 112 |
| Injector/Drenche, Vaxi-Drench 15 | 65, 357 | Jorvet 3.5mm Cortical Self Tapping Screws | 239 | Jorvet Farrowing Snare | 100 |
| Ink, Jorvet Tattoo | 141, 367 | Jorvet 3 Corner Beaker | 317 | Jorvet Feline Litter Magnet | 144 |
| Inoculation Loops | 325 | Jorvet Absorbent Cotton Balls | 173 | Jorvet Flowmeter | 216 |
| Insertion Coil and Brush | 370 | Jorvet Anesthesia Mask | 302 | Jorvet Fluff Dressing Bandage | 171 |
| Inspector Zoom Dissecting Microscope | 285 | Jorvet Aspiration Kit | 229 | Jorvet Foam Collar | 138 |
| Instrument, Behney Ear | 100 | Jorvet Aspiration Suction Unit | 229 | Jorvet Foreign Body Retriever | 297 |
| Instrument, Equine Uterine Biopsy | 106 | Jorvet Audio-visual Alarm | 299 | Jorvet Gallon J-Jelly Lube | 125 |
| Instrument Brush | 270 | Jorvet Avian Oral Speculum | 95 | Jorvet Gas-Vak Scavenging Tune-up Kit | 216 |
| Instrument Clamp Covers | 85 | Jorvet Bleeding Needle | 370 | Jorvet GasVak™ Scavenging System | 216 |
| Instrument Color Code ID Ring | 107 | Jorvet Bone Chisel | 268 | JorVet Gauze Roll Bandage | 172 |
| Instrument ID Roll Tape | 107 | Jorvet Bone Marrow Needle | 69 | Jorvet Gel Cast | 232 |
| Instrument Lubricant | 271 | Jorvet Bone Pin Counter Punch | 103 | Jorvet Glucose Urine Test Strip | 288 |
| Instrument Lubricant Concentrate | 271 | Jorvet Booster Repair Kit | 301 | JorVet Gram Stain | 320 |
| Instrument or Spay Pack Tray | 127, 211 | Jorvet Bovi-Vet Calf Drencher | 348 | Jorvet Halt Spoon Curette | 95 |
| Instruments, Equine Dental | 344, 352 | Jorvet Bovine Hobble Strap | 354 | Jorvet Heavy Duty Nail Scissors | 156 |
| Instrument Sorter | 115 | Jorvet Breathe Safe Respiration Monitor | 295 | Jorvet Hemostatic Ligation Clips/Apliers | 48 |
| Instrument Tray | 211 | Jorvet Brown "Cling" Gauze | 173 | Jorvet Hog Ringer | 363 |
| Insulin Syringe | 60 | Jorvet Bulb Syringe | 62 | Jorvet Hoof Buffer | 366 |
| Integra & Ragalia Oxygen Concentrators | 301 | Jorvet Calf Snare | 354 | Jorvet Hoof Knife | 104 |
| Integra/Miltex Dental Mirror Handle | 341 | Jorvet Cancellous Lag Screw 4.0mm | 249 | Jorvet Hoof Knife Hone | 104 |
| Intelect® Transport Ultrasound | 290 | Jorvet Capillary Sealant Tray | 269 | Jorvet Hose Assembly Kit for JOR744C | 301 |
| Interactive Cat Tower | 143 | Jorvet Carbide Float Blade | 345 | Jorvet House Curette | 95 |
| Intertarsal Arthrodesis Compression Plate | 251 | Jorvet Cardiotax ECG | 293 | Jorvet Humidifier | 313 |
| Intracell Powder | 180 | Jorvet Cardiotax Paper | 293 | Jorvet Intelect® Vet system | 228 |
| Intraosseous Infusion Needle | 69 | Jorvet Cat/Wildlife Gloves | 177 | Jorvet IV Fluid Warmer | 209 |
| Introducer, Leighton Bone Pin | 126, 266 | Jorvet Catheter Plug | 117 | Jorvet IV Jacobs Pin Chuck | 258 |
| Iodine Cup | 127, 212 | Jorvet OCL Suture System Starter Kit | 262 | Jorvet K-wire/Small Pin Punch Smaller | 99 |
| Iodine Stain Kit | 320 | Jorvet Central Venous Catheter Kit | 204 | Jorvet K-Wire Cutter | 268 |
| Iris Forceps | 80 | Jorvet Cerclage Wire | 98 | Jorvet KE Plus clamp | 256 |
| Iris Scissors | 86 | Jorvet Cerclage Wire Passer | 98 | Jorvet Ketone Urine Test Strip | 288 |
| Iris Tissue Forceps | 83 | Jorvet Compression Plates 2.0mm | 242 | Jorvet Laparotomy Sponges | 172 |
| Irigating Cannula | 123, 364 | Jorvet Cortical Screws 2.7mm | 247 | Jorvet Large Animal IV Catheter | 203, 369 |
| Irivet Wound Irrigation Syringe Kit | 69 | Jorvet Cortical Self-Tapping Screw | 253 | Jorvet Lateral Flow Vented Needle | 69 |
| Isoflurane, Tech V | 299 | Jorvet Cotton Bandage Sheeting | 173 | Jorvet LeFill Balling Gun | 353 |
| Isoflurane Inhalant Anesthetic | 299, 301 | Jorvet Cotton Roll | 173 | Jorvet LigaFiba Braided Polyethylene Fiber | 262 |
| Isoflurane Vaporizer | 298 | Jorvet Crit-Carrier | 323 | Jorvet Lightweight IV Infusion Pump | 204 |
| Isolation Gowns | 111 | Jorvet Cruciate Suture Needle | 261 | Jorvet Lightweight Rodent Mouth Gag | 337 |
| Isopropyl Alcohol | 115 | Jorvet Curved Graft Passer | 98 | Jorvet Mason-Meta Splint | 233 |
| Items, Cryosurgery Accessory | 217 | Jorvet Danish IV Needle | 202 | Jorvet Mason Nylon Line | 261 |
| IV Administration Set | 202 | Jorvet Digital Thermometer Flexible Tip | 297 | Jorvet Meniscus Probe | 261 |
| IV Catheter | 203 | Jorvet Dip Quick Stain | 320 | Jorvet Multi-dose Balling Gun | 353 |
| Ivermectin Paste | 333 | Jorvet Disposable Aprons | 187 | Jorvet Multi-Station GasVak Unit | 216 |
| IV Extension w/Needleless Valve & T-Port | 206 | Jorvet Disposable Blood Pressure Cuff | 269 | Jorvet Nano Paste Syringe | 107 |
| IV Sets & Supplies | 202, 208 | Jorvet DogLegs Adjustable | 236 | Jorvet Non-Woven Sponge Gauze | 171 |
| IV Set Extra Length | 209 | Jorvet Dorsi-Flex Assist | 231 | Jorvet Nylon Forceps | 82 |
| IV Set Mini-Drip Xtra Length | 209 | Jorvet Dose Syringe | 60 | Jorvet OB Chain | 100 |
| | | Jorvet Double Line | 261 | Jorvet OB Drop Wire Guide | 99 |
| | | Jorvet Double Line and Needle | 261 | Jorvet OB Saw Set | 99 |
| | | | | Jorvet OB Saw Wire | 99 |
| | | | | Jorvet OB Wire Guide | 99 |
| | | | | Jorvet OB Wire Handle | 99 |
| | | | | Jorvet Optiloupe® | 290 |
| | | | | Jorvet Optivisor® | 290 |
| | | | | Jorvet Oral Calf Drencher | 348 |
| | | | | Jorvet Orthopedic Punched Hole Gauge | 258 |
| | | | | Jorvet Orthopedic Surgical Pack | 236 |
| | | | | Jorvet Oval Hoof Knife | 104 |
| | | | | Jorvet Oxy Cage | 300 |
| | | | | Jorvet Oxygen Catheter | 313 |
| | | | | Jorvet Oxygen Connectors and Gas Hose Assembly | 304 |
| | | | | JORVET Oxygen Fittings | 305 |
| | | | | Jorvet Oxygen Supply Tubing | 313 |
| | | | | Jorvet Pet Nursing Kit | 161 |
| | | | | Jorvet Pig OB Forcep | 82 |
| | | | | Jorvet Plastic Thermometer Case | 297 |
| | | | | Jorvet Plush Toys | 145 |
| | | | | Jorvet Polansky Speculum | 106 |
| | | | | Jorvet Prod Extension Handle | 349 |
| | | | | Jorvet Prod with Batteries | 349 |
| | | | | JorVet Prolapse Kit | 368 |
| | | | | Jorvet Pro Scale Polishing Unit | 336 |
| | | | | Jorvet Quick Splints (Pair) | 232 |
| | | | | Jorvet Rabbit/Rodent Dental Head Support | 337 |
| | | | | Jorvet Rabbit/Rodent Dental Starter Kit | 337 |
| | | | | Jorvet Resistor Restraint Gloves | 177 |
| | | | | Jorvet Rodent Cheek Dilator | 337 |
| | | | | Jorvet Rodent Molar Cutter | 105 |
| | | | | Jorvet Rodent Molar Extractor | 337 |
| | | | | Jorvet Rubberized OB Suit | 188 |
| | | | | Jorvet Ruskin Rongeur | 267 |
| | | | | Jorvet Screwdriver with Sleeve | 244 |
| | | | | Jorvet Self Adherent Bandage | 171 |
| | | | | Jorvet Shoecover | 187 |
| | | | | Jorvet Silicon Endotracheal Tube with Wire Reinforcement | 310 |
| | | | | Jorvet Single Collection Unit | 205 |
| | | | | Jorvet Sink Soak Tray | 227 |
| | | | | Jorvet Small Angles Bone Cutter | 91, 268 |
| | | | | JorVet Small Animal Artificial Insemination Kit | 326 |
| | | | | Jorvet Smaller K-wire/Small Pin Punch | 268 |
| | | | | Jorvet Small Fragment Forceps | 91, 265 |
| | | | | Jorvet Small Lowman Bone Clamp | 268 |
| | | | | Jorvet Small Pin Vise | 268 |
| | | | | Jorvet Smoke Shark | 227 |
| | | | | Jorvet Soda Lime Pre-Filled Canister | 299 |
| | | | | Jorvet Spay/Neuter Surgery Pack | 108 |
| | | | | Jorvet Split KE Clamp | 256 |
| | | | | Jorvet Squeeze Jet | 354 |
| | | | | Jorvet Steel Stainless K-Wire | 268 |
| | | | | Jorvet Steri Container | 272 |
| | | | | Jorvet Sterile OB Sleeve | 174 |
| | | | | Jorvet Sterile Swann-Morton | 127 |
| | | | | Jorvet Sterilization Tubing | 269 |
| | | | | Jorvet Stifle Lever | 263 |
| | | | | Jorvet Stille-Luer Rongeur | 92 |
| | | | | Jorvet Stretch Conforming | 171 |
| | | | | Jorvet Suction Catheter | 118 |
| | | | | Jorvet Surgical Adhesive Tape | 179 |
| | | | | Jorvet Surgical Scissors | 89 |
| | | | | Jorvet Surgicutt Bleeding Time Devices | 296 |
| | | | | Jorvet Suture Kits | 50 |
| | | | | Jorvet T-bar OB handle | 100 |
| | | | | Jorvet Tattoo Ink | 141, 367 |
| | | | | Jorvet Teat Blade | 104 |
| | | | | Jorvet Tenotome | 107 |
| | | | | JorVet Thirsty Stomach Pump | 349 |
| | | | | Jorvet Tooth Punches | 352 |

| | | | | | | | |
|---|--------------|---|-------------------|--|----------|---|--------------|
| Jorvet Transparent Dressing | 180 | Lap Sponge Non-sterile | 172 | Lube, Jorvet Gallon J-Jelly | 125 | Medicine Cup | 127, 212 |
| Jorvet Trocar-Trocar I. M. Pins | 103 | Lap Sponge Sterile | 172 | Lube, Spray | 109 | Medium, Dermatophyte Test | 296, 326 |
| Jorvet Ultraviolet Wood's Light 110v | 291 | Laryngoscope, Bovine Heavy-Duty | 295 | Lubricant, Dental Handpiece | 335 | Medium, Zinc Sulfate Fecal Flotation | 288, 326 |
| Jorvet Ultraviolet Wood's Light 220v | 291 | Laryngoscope | 314 | Lubricant, Instrument | 271 | Medium Fixation Type I Kit | 238 |
| Jorvet Umbilical Clamps | 103 | Laryngoscope Handle | 279 | Lubricant, Silicone | 62 | Megapixel, invid 8.1 | 225 |
| Jorvet Umbilical Tape | 50 | Laryngoscope Replacement Light Bulb. | 279 | Lubricating Jelly | 125 | Meier Dental Wedge | 360 |
| Jorvet Vapor Wand | 300 | Latex Elastrator Bands | 358 | Lucae Forceps | 81 | Meister Equine Mouth Gag & Light | 360 |
| Jorvet Verbrugge Forceps | 265 | Lavage Kit | 131 | Luerlock, Extension Set 30" w/Male Spin | 206 | Memorials, Pet Keepsake | 168 |
| Jorvet Hoof Knife Set | 104 | Lax, Cat | 159 | Luerlock, Micro Bore "T" Extension w/ | 206 | Men's Lab Coat | 189 |
| Jorvet White Silt Light | 291 | Lazy Mouse Laser | 143 | Luerlock, Standard Bore "T" Extension w/ | 206 | Meniscus Knife | 98, 263 |
| Jorvet X-span Tubular Dressing | 181 | LDA Toggles Suture Button | 367 | Luxator, Crossley Molar | 339 | Mesh, Polyester Surgical | 126 |
| K | | Lead, Animal | 142 | Luxator, Crossley Rabbit Incisor | 339 | Mesh Cat Restraint Bag | 140 |
| K-9 Float Coat | 167 | Lead, Bull | 349 | Lys OB Handle | 99 | Metrimist Deodorizer | 273 |
| K-Wire | 99, 100, 268 | Leash, Retriever Retractable | 142 | M | | Metzenbaum Scissors | 87 |
| Kantrowitz Thoracic Forceps | 81 | Leather Muzzle | 138 | Macintosh Laryngoscope Blade | 314 | Michele Trephine | 297 |
| Keith Needle | 76 | Leather Restraint Gloves | 177 | Magic Coat Flea and Tick Shampoo | 158 | Michel Forceps | 81 |
| Kelly-Rankin Forceps | 81 | Lectro-Kennel, Deluxe | 160 | Magic Coat Protein Tearless Shampoo | 158 | Micro-Touch® Gloves | 174, 175 |
| Kelly Forceps | 81 | Lectro Cover | 160 | Magic Coat Puppy Tearless Shampoo w/Noe Vera | 158 | Micro Adson Dressing Forceps | 78 |
| Kerfix Type Gauze Rolls | 172 | Left Curved Hoof Knife | 104, 126 | Magill Forceps | 81 | Micro Bore "T" Extension | 206 |
| Ketch-All Pole | 140 | Leg, Parsons 4- Strap | 368 | Magna Arm Magnifier for Xray Illuminators | 327 | Microchips, AKC Companion Animal Recovery | 126 |
| Ketogel | 371 | Leg Drapes | 112 | Magnet, Jorvet Feline Litter | 144 | Micro Friedman Rongeur | 92 |
| Keyes Biopsy Punch | 106 | Leighton Bone Pin Introducer | 126, 266 | Magnetic Pet Pad | 166 | Micro Friedman Rongeur Curved | 267 |
| Key Periosteal Elevator | 93, 267 | Leksell Rongeur | 92 | Magnets, Rumen | 349 | Microhematocrit Capillary Tubes | 289, 326 |
| Key Periosteal Elevator | 93 | Lempert Rongeur | 92 | Magnifier, Head | 290 | Microhematocrit Centrifuge | 322 |
| Killer, Ear Mite | 162 | Lens, Indirect Viewing | 282, 283 | Magnum Handling Gloves | 177 | Microhematocrit Reader Card | 289 |
| Killian Speculum | 106, 347 | Lens, Optimal Headlamp Magnifying | 120 | Mallet, Slide | 319 | Micropore® Tape | 179 |
| Kimwipe | 318 | Lesser Suture Retrieval Forceps | 81 | Malacetic Shampoo, Conditioner, Wet Wipes | 158 | Micro Scalpel Blades | 74 |
| Kim2 Clipper | 154 | Lever, Jorvet Stifle | 263 | Malecot Catheter | 117 | Microscope | 284-286, 318 |
| Knee Brace for Emasculator | 358 | Lever, Stifle | 97 | Male Luerlock Adapter | 207 | Microscope Side Holder | 319 |
| Knee Length Lab Coat | 189 | Lichly Knife | 104 | Mallet | 102, 268 | Microscope Slides | 319 |
| Knife, Embryotomy | 101 | Lichly Test Knife | 365 | Manometer | 298 | Micro Tooth Meniscus Clamp | 85, 263 |
| Knife, Hoof | 366 | Lift, E-Z | 226 | Manual and Ultrasonic Instrument Detergent | 271 | Mid-shaft Positive (Raised) Threaded External | 238 |
| Knife, Jorvet Hoof | 104 | LigaFiba Braided Polyethylene Fiber (Material Only) | 48 | Mare Catheter | 369 | Milk, Surgical Instrument | 270 |
| Knife, Jorvet Oval Hoof | 104 | LigaFiba ISO Toggle Suture | 262 | Marq-Easy Thermoplastic Splint Sheets | 234 | Milk Tubes | 371 |
| Knife, Left Curved Hoof | 126 | LigaFiba Lateral Suture | 48, 262 | Martin Cartilage Clamp & Scissors | 85, 86 | Miller Laryngoscope Blade | 279, 314 |
| Knife, Lichly Test | 365 | Ligament Meniscus Clamp | 85 | Mask, Anesthesia | 302 | Mini-Rongeur, Duck-Billed | 263 |
| Knife, Meniscus | 98, 263 | Lights | 213, 290-291, 352 | Mask, Non-Rebreather | 299 | Mini-Spike | 207 |
| Knife, Newberry Castrating | 358 | Light Source Complete | 227 | Mask, Surgery | 112 | Mini-Vid Microscope Eyepiece Camera | 225 |
| Knife, Small Loop Abscess | 104, 359 | Lightweight Rodent Mouth Gag | 105 | Mask One Way Valve | 302 | Mini and Chisel Blade Handles | 74 |
| Knife, Swiss | 104, 126 | Lime, Soda | 299 | Masks, Surgical | 112 | Mini Baby Kems Bone Holding Forceps | 91, 265 |
| Knife, Test | 364 | Linear Fixation | 239 | Mason Line Crimp Tubes | 261 | Mini Basic LV Set | 209 |
| Knife Storage Tray (Sterilization Tray) | 272 | Lint-Free Lens Paper | 318 | Masson | 76 | Mini Blades | 74 |
| Knives, Necropsy | 109 | Lint Pick Up Device | 156 | Mastitis Indicator, Test | 354 | Mini Bone plate 2mm | 246 |
| Knowles Bandage Scissors | 87 | Lip, Extension Set 30" Male Luer | 206 | Mat, Anti-Vibration | 322 | Mini Closed Probe | 217 |
| Kong | 146, 165 | Lip Retractor | 97 | Mat, Safe 'n Warm | 134 | Mini Finchietto Rib spreader | 102 |
| Krey Hook | 353 | Lister Bandage Scissors | 87, 126 | Mat, Thermo Pet | 160 | Mini Gelpi Retractor | 96 |
| L | | Liston Bone Cutting Forceps | 91, 267 | Material, Towel Drape Plain ACT | 113 | Mini Hohman Retractor | 96, 263 |
| Lab Eartags | 318 | Littauer Forceps | 81 | Material, Vet-lite Cast | 235 | Minivid Camera | 225 |
| Label, Sterile OB Lube-Vet | 133 | Littauer Stitch Scissors | 87 | Mathieu Needle Holder | 76 | Mirror, Dental | 341 |
| Labeled, Sundry Glass Jars | 199 | Litter Pan | 147 | Mattress, Buster Comfort | 300 | Mirror, EquiVet Dental | 345, 350 |
| Lab Litter | 134, 147 | Littmann Stethoscopes | 277, 278 | Maxitherm Vinyl Blankets | 226 | Mirror, Mouth | 341 |
| Laboratory Stool | 218 | Live/Dead Semen Stain | 320 | Mayo-Stille Scissors | 88 | Mittens, X-Ray | 329 |
| LabScope | 265-286 | Llama Vaginoscope | 295 | Mayo Dissecting Scissors | 87 | Mitts, Pet | 161 |
| Lacrimal Needle | 70 | Load/Neutral Drill Guide | 260 | Mayo Hegar Needle Holder | 77 | Mobile Anesthesia Unit | 298 |
| Lactated Ringers IV Solution | 205 | Lock, Cannulated Luer | 264 | Mayo Tray | 211 | Mobile Instrument Mayo Stand | 211 |
| Lactophenol Cotton Blue | 320 | Lock, Double Door Double | 219 | McCall's Curette | 339 | Model, Canine, Feline | 330-331 |
| Ladies Full Length Lab Coat | 189 | Lock, Hog Holder with | 363 | McIntosh Laryngoscope Blade | 279, 314 | Modified Gigli Bone Saw | 99 |
| Lambing Snare | 367 | Lock, Single Door Double | 219 | McLean Folding Net | 140 | Modified Stifle Retractor | 94, 264 |
| Lamb Nipple | 367 | Lock, with Female Luer | 207 | McLean OB Forceps | 81 | Modular Osteotome & Blades | 94 |
| Lambotte Osteotome | 93 | Locking Plug for TPLD Locking Screw | 253 | McMaster Egg Worm Slide | 319 | Mohr Medical Case | 226 |
| Laminectomy Rongeurs | 92, 267 | Locking Screw Drill Guide | 253 | McPherson Mouth Gag | 360 | Moleskin, X-Heavy | 181 |
| Lamp, Adjustable Head | 229 | Locking Screws 3.5mm | 253 | Mead Mallet | 102 | Monitor, Doppler Ultrasonic Blood Flow | 289 |
| Lamp, Burton AIM-50 Floor | 213 | Long T Plate | 252 | Med-Vet Encore Scrubs | 183 | Monitor, Jorvet Breathe Safe Respiration | 295 |
| Lamp, Halogen | 283 | Loop, Electrode | 215 | Med-Vet Premier Scrubs | 183 | Monitor, Vet-Alarm Respiratory | 295 |
| Lamp, Surgical Head | 120 | Loop, Fecal | 123, 297 | Medical Grade Silicone Elastomer Tube | 130 | Monitor, Vital Signs | 213 |
| Lamp, Vacuum | 282 | Loops, Inoculation | 325 | Medical Storage Cabinet | 218, 219 | Monocryl® Suture | 46 |
| Lamp, Welch Allyn Halogen | 283 | Loopyl's Needle | 70 | Medication Cart | 220 | Monject Needles & Syringes | 55-57 |
| Lane Elevator | 93 | Lorna Towel Clamp | 85 | Medication Caps | 361 | Monosyn® Suture | 47 |

| | | | | | | | |
|---|-----------------|---|-------------------------|-----------------------------------|-------------------|---|-----------------------------|
| Mop Bucket with Flinger | 274 | Nylon Padded Carry Case for X-ray Illuminator | 327 | Oxygen | 299-306, 307, 312 | Pet Mitts | 161 |
| Mortar with Pestle | 321 | Nylon Sponge Forceps | 82 | P | | Pet Pill Crusher | 159 |
| Mosquito Forceps | 82 | Nylon Suture | 42 | P-Cup | 199 | Pet Piller | 142 |
| Mothering Kit | 161 | Nylon Syringe | 62 | Packs, Instrument | 107-109 | Pet Rake | 153 |
| Mount, Space-Saver IV Cage | 208 | Nylon Syringe Jorgensen | 62 | Pack, Breath Fresh Refill | 302 | Pet Scale | 292 |
| Mounts, Dental X-ray Film | 329, 344 | Nylon Thumb Forceps | 82 | Pack, Jorvet Orthopedic Surgical | 236 | Pet Shedder & Slicker | 151 |
| Mouth Gags | 338 | Nylon Towel Clamp | 82 | Pack, Ophthalmic Surgery | 100 | Pezzar Catheter | 118 |
| Mouth Mirror | 341 | O | | Pad, Abdominal (Combine) | 180 | PGA-Braided Absorbable Suture | 41 |
| Multi-Fold Towel | 125, 224 | Oasis Cohesive Tape | 178 | Pad, Buster Aural Hematoma | 136 | PGA Suture Cassette | 41 |
| Muzzles | 137-139 | Oasis Liquivet Tissue Adhesive | 50 | Pad, Comfort Pak Warming | 166 | pH, Buffer Solution | 321 |
| N | | Oasis Porous Tape | 179 | Pad, Eye | 179 | pH Indicator Paper | 288 |
| Nail Clippers | 153 | Oasis Skin Stapler | 49 | Pad, Magnetic Pet | 166 | pH Indicator Strips | 288 |
| Nail File | 153 | OB Products | 100, 133, 188, 353, 371 | Pad, Snugglesafe Heat | 128 | pH Replacement Electrode | 321 |
| Nail Splitter | 91 | Obstetrical Towellette | 274 | Padding, BSN Specialist Cast | 180 | Pharmacy Folding Cartons | 200 |
| Nail Trimmer for Dogs | 156 | OdorzOut | 276 | Padding, Cast | 230 | Phase Contrast Kit | 286 |
| Nano Paste Syringe | 370 | Off, Odor | 276 | Padding, Cotton Cast | 230 | Physicians Balance Beam Scale | 293 |
| Narcotic Cabinets | 219 | Ohio Chemtron | 305 | Padding, X-Lite Foam Cast | 230 | Pick, EquiVet Dental | 344, 352 |
| Nasal Cannula | 312 | Ohio Quick Connect Barbed fitting | 304 | Pads, Absorbent Wound | 181 | Pick, EquiVet Dental Irrigation | 350 |
| Nasal Speculum | 102 | Oil, Clipper Blade | 155 | Pads, Prep | 115 | Pick, Hoof | 104 |
| Nazzy Ferret Mouth Gag | 105, 337 | Oil, Immersion | 318 | Pads, Wee-Wee | 167 | Pick, Root Tip | 337 |
| Nebulizer | 313 | Oil, Microscope Objective 50X | 285 | Pan, Litter | 147 | Pierce Colibri Type Corneal Forceps | 82 |
| Nebulizer/Compressor | 215 | Ointment Jar | 212 | Pantarsal Arthrodesis Plate | 251 | Pig OB Forcep | 265 |
| Necropsy Knives | 109 | Ointment Jar With Handle | 127 | Pants, Rubberized OB | 188, 371 | Pig Tooth Nipper | 342, 359 |
| Needles, Oasis, B-D, Monoject54-70, 205, 261, 370 | | Olsen Hegar Needle Holder | 77 | Paper, Exam Table | 127 | Pill Counting Tray | 123 |
| Needle, Keith | 76 | Omega 3 Gel Caps | 159 | Paper, Jorvet Cardiofax | 293 | Pill Crusher-Splitter | 200 |
| Needle Chart | 41 | Omni Exam Table with Scale | 221 | Paper, Lint-Free Lens | 318 | Pill Envelope | 200 |
| Needle Counter | 62 | OMROD Orthopedic Button | 266 | Paper, Optical Lens | 326 | Pill Envelopes | 200 |
| Needle Free Multi Dose Vial Adaptor | 207 | Opening Site Aperature | 217 | Paper, pH Indicator | 288 | Piller, Pet | 142 |
| Needle Holder | 76 | Operating Scissors | 88 | Paper Towel C-Fold | 125, 224 | Pill Splitter | 334 |
| Needle Rack | 50, 75 | Operating Sheath | 225 | Paper Towel Dispenser | 224 | Pins, Fixation | 100, 103, 109, 237-242, 260 |
| Needles, Reverse Cutting Suture | 51, 75 | Ophthalmoscope | 280-282 | Parson's | 368 | Pin Cutter | 103, 240 |
| Needles, Spinal | 370 | Ophthalmic Surgery Pack | 100 | Parvosan Disinfectant | 273 | Pin Removal Forceps | 103, 241 |
| Needles, Suture | 75 | Optical Lens Paper | 326 | Passer | 98, 100, 263-264 | Pink Gloves | 174 |
| Needles, Taper Suture | 51, 75 | Optiloupe®, Jorvet | 290 | Paste, CET Fingerbrush with | 159 | Pipettes | 317, 334 |
| Needles- Feeding | 66 | Optimal Headlamp Magnifying Lens | 120 | Paste, Ivermectin | 333 | Piston Syringe | 62 |
| Needless, DA Suture | 50 | Optivisor®, Jorvet | 290 | Paste, Prophylaxis Polishing | 336 | Plain Gut Suture | 43, 45 |
| Needless, Double-Curved Suture | 50 | Oral Calf Feeder | 348 | Paste, Tattoo | 141 | Plastic Bag for Infusion Set | 204 |
| Needless, Heavy Duty Suture | 51 | Oral Surgery Rongeur | 92 | Patch, Eyesaver™ Eye | 361 | Plastic Expandable Test Dilator | 364 |
| Needle Sterilization Rack | 50, 75 | Organize, Microscope Accessories Custom | 318 | Paw Print Petflex® Tape | 178 | Plastic Forceps | 321, 326 |
| Nelcor, Pulse Oximeter Sensor | 287 | Ortho Chuck Extension Only | 258 | PDO Suture | 40 | Plastic Gallon Bottle with Screw Top | 198 |
| Neon Surgical Glove | 176 | Orthopedic & OB - Wire Products | 99, 100 | PDS Suture | 46 | Plastic Medicine Dropper | 198 |
| Nequizer Equine Nebulizer Kit | 361 | Orthopedic, Hard-back | 101 | Pearson Raised Thread Pins | 242 | Plastic Scalpel Handle | 74 |
| Net, McLean Folding | 140 | Orthopedic Casting Tape | 230 | Pen, Portable Cordless Cautery | 120 | Plastic Splints | 232 |
| Neubauer Hemacytometer | 318 | Orthopedic Distractor | 102, 268 | Penlight, Exam | 125 | Plastic Squeeze Bottle with Flip Top | 200 |
| Newberry Castrating Knife | 358 | Orthopedic Drill Adaptor | 105 | Penlight, Halogen | 120, 291 | Plastic Sterile Test Infusion Cannula | 365 |
| Nice n' Fresh Moist Towelettes | 274 | Orthopedic Drill Case | 243 | Penrose Drain & Tubing | 116 | Plastic Urethral Catheter | 203 |
| Nippers | 90-92, 342, 359 | Orthopedic Drill Case w/9 Drill Bits | 243 | Percussion Chisel | 341, 359 | Plastipad Urethane Blanket | 226 |
| Nipro Syringes & Needles | 61 | Orthopedic Drills & Accessories | 258 | Percussion Mallet | 102 | Plastipad Urethane Pad Repair Kit | 161 |
| NIT - Natural Test Insert | 365 | Orthopedic Power Drill Set | 258 | Periodontal Scalers | 341 | Plates, Orthopedic | 247-254 |
| Nitrile Gloves | 174 | Orthopedic Stockinette | 230 | Periosteal Elevator | 93, 267 | Plate Bending Pliers | 266 |
| Nitrogen Manifold | 305 | Osteometer for TTD | 254 | Periosteotome | 340 | Pliers, Plate Bending | 266 |
| No-Pull Trainer | 142 | Osteotome, Jorgensen | 93, 268 | Perivaginal Tape | 133 | Pliers, Tattoo | 367 |
| Nolvasan S Cleaner | 270 | Osteotome, Lambotte | 93 | Perry Original Surgeon Gloves | 175 | Plug, Catheter | 117 |
| Non-Adherent Dressing | 180 | Osteotome, Modular | 94 | Personal Eyewash Station | 221, 324 | Plus, Cat Grass | 146 |
| Non-Rebreather Mask | 299 | Osteotome, Super-Slim Block Resection | 94 | Pestle, Mortar with | 321 | Plush Vegetable Toy with Squeaker | 143 |
| Non-Rebreathing Circuit | 302 | Osteotomy Wedge | 254 | Pet Bath Hose | 157, 221 | Pneumatic Stool w/Back Rest | 218 |
| Non-Tip Stainless Steel Bowls | 210 | Oster Blade Wash® | 155 | Pet Brushes | 152 | Pocket Balances | 222 |
| Non-Woven Gauze Sponges | 171 | Oster Kool Lube 3® | 155 | Pet Burial Boxes | 168 | Pocket Pet Carrier for Small Animals | 201 |
| Noose, Grooming | 157 | Ostertag Blunt Eye Hook | 353 | Pet Cage Systems | 223 | Pointer, Binocular Microscope Eye Piece | 284 |
| Normosol-RIV Fluids | 205 | Osty Core Bone Biopsy Needle | 68 | Pet Carrier | 148, 201 | Polansky Speculum | 347 |
| Northbent Stitch Scissors | 88 | Otic, Malacetic | 158 | Petchek Heartworm PF Antigen Test | 296 | Poles | 140-141 |
| Ntrafix Air IV Set | 209 | Oticare P Ear Powder | 162 | Pet Dematter | 151 | Polyester Surgical Mesh | 126 |
| Nutrient Bones | 146 | Otomax | 162 | PetDental Care Kit | 159 | Polyethylene Coated Gown | 111, 186 |
| Nylabone Puppy Starter Kit | 143 | Otosopes | 225, 280-282, 294 | PetDental Toothpaste | 159 | Polypropylene Specula | 283 |
| Nylon Brush | 270 | Ovals, Amber Plastic Graduated | 198 | Pet Fleasom | 150 | Polypropylene Suture | 44 |
| Nylon Feline Restraint Bags | 140 | Overalls, Rubberized OB | 188, 371 | Petflex® Tape | 178 | Poole Suction Handle | 119 |
| Nylon Hemostat Forceps | 82 | Oxegrip | 304 | Petite Splint | 233 | Pop-off Valve | 298 |
| Nylon Muzzle | 139 | Oximeter | 287 | Pet Keepsake Memorials | 168 | Pop-Off Valve Restrictor | 301 |

- Porous Tape 179
 Port, Safesite Injection 207
 Portable Bunsen Burner 321
 Portable Cordless Cautery Pen 120
 Portable Scales 292-293
 Portable Digital Scale w/Stainless Tray 222
 Portable Light Source 227
 Portable Mechanical Pediatric Scale 292
 Portable Oxygen Delivery System 303
 Portable Water Tank 336
 Portafuge 322
 Positioners 116, 133, 328, 344
 Post Mortem Scissors 89
 Potassium Hydroxide 10% 320
 Pouch, Sterilization 269
 Pouch, Technovit Dual 255
 Pouches, Bio Hazardous Disposable 201
 Povidone Iodine Products 115, 269
 Powder, Hema Stop Styptic 233
 Powder, Intracell 180
 Powder, J-Lube 125
 Powder, Oticare P Ear 162
 Powder, Styptic 162
 Powder, Technovit 362
 Powder-Free & Powdered Gloves 174-175
 Power Drill Adapter 258
 PowerFlex® Tape 178
 Pre-Cut Braunamid 44
 Pre Contoured Plate 253
 Premium Float Line 345, 350
 Premium German Skin Stapler 49
 Premium Sterile Surgeon Gown 110, 186
 Premium Sterile Surgeon Gown (D) 186
 Press, Bone Plate 253
 Press, Jorvet Extra Large Bone Plate 253
 Primary Check Removal Tool 312
 Probing with Extractor 348
 Probe, Closed 217
 Probe, Explorer/Measuring 341
 Probe, Flat Closed 217
 Probe, Free Martin 367
 Probe, Jorvet Meniscus 261
 Probe, Mini Closed 217
 Probe, Palate Closed 217
 Probe, Stainless 341
 Probe Covers 297
 Proctor Float 346, 351
 Professional Towel 125
 Prolene® Suture 45
 Prophylaxis Dental Kit 338
 Prophylaxis Polishing Paste 336
 Propyl Paste Ring 336
 Protect-A-Pad Cover Fits 226
 Protector, Cut-Pad Dog Pad 161
 Protector, EquiVet Dental Rasps 350
 Protector, KE Tissue 256
 Protector, OB Shoulder 133, 188, 371
 Protector, Soft Tissue 336, 352
 Protector, TheraPaw 162
 Puller, Calf 352
 Puller, Hoof Crease Nail 90, 104
 Pulse Oximeter & Sensors 286-287
 Pump, Warm Water 213
 Pump, Drench 123, 349
 Pump, Flux Rumen Infusion 348
 Pump, IV 208
 Pump, Jorvet Lightweight IV Infusion 204
 Pump, Jorvet Thirsty Stomach 349
 Pump, Uterus 131
 Punch, Bone Pin Counter 260
 Punch, Disposable Skin Biopsy 106
 Punch, Jorvet Bone Pin Counter 103
 Punch, Jorvet Smaller K-wire/Small Pin 268
 Punch, Keyes Biopsy 106
 Punch, T-Handle Blade 351
 Punch-Straight, Tooth 342
 Punctures, Jorvet Tooth 352
 Puppy OB Forceps 82
 Puritan-Bennett 304
 Putti Bone Rasp 94
 Putty, Epoxy ESF 255
Q
 Quick Read Handheld Digital Thermometer 297
 Quick Release Dog Pole 141
 Quick Release Tap Handle 256
 Quick Shot X-ray Cassette 328
R
 Rabbit Burr-Kit 342
 Rabbit Speculum LED Light 337
 Rack, Acrylic Blood Tube 316
 Rack, Bone Screw 245, 264
 Rack, Coated Cage 224
 Rack, Endotracheal Tube 311
 Rack, Heartworm 316
 Rack, Needle 50, 75
 Rack, Test Tube 316
 Rack, Universal Cube Test Tube 323
 Radiograph Cassette Tunnel 328
 Rainbow Tower of Power 144
 Rake, Pet 153
 Rake, Undercoat 153
 Rakom, Wood Pet 153
 Rapid-Vit 6 Technovit Kit 362
 Rasps 94, 105, 337, 339, 350
 Rawhide Chew-Round Safety Knot 145
 Reagent Strips 288
 Rechargeable Handle & Battery 279, 281
 Reconstruction Plate Pliers 266
 Recova-Clear Recovery Collar 135
 Rectal Ring 123
 Redden Navicular Stand 328
 Red Rubber Cuffed 308
 Reduction Forceps with Spinlock 102, 265
 Refill, Fecal-Ova Float 288
 Refractometer, Clinical 289
 Regulator, Click Style Oxygen 303
 Reimer Emasculator Stainless Steel German 106
 Reister Diagnostic Kit 280
 Reister Oscope 280
 Repro, Trinocular 286
 Resco Nail Trimmer 156
 Rest, Black Premium Pneumatic Stool w/Back 218
 Rest, Pneumatic Stool w/Back 218
 Restraint, Auspex Avian 133
 Restraint, Trap Transfer 141
 Restraint, Snarem 141
 Restrictor, Pop-Off Valve 301
 Resuscitation Bag 303
 Retainer, Ewe Prolapse 131
 Retainer, Viscera 365
 Retractable Lift Assisted 298
 Retractors 96-97, 263-264, 345
 Retractor Guards 97
 Retractors/Orthopedic & OB - Wire Products 98
 Retractor System 97
 Retriever, Jorvet Foreign Body 297
 Retriever Retractable Leash 142
 Reusable Bipolar Forceps 121, 214
 Reusable Black Rubber 303
 Reusable Electrodes 121, 214
 Revelation 3 microscope with Min/Vid RCA 287
 Reverse Cutting Suture Needles 51, 75
 Revolver, Henke Roux 63, 355
 Reynold's Equine Tooth Extractor 342, 350
 Ri-Mini Ophthalmoscope & Oscope 280
 Ribbon Iris Scissors 89
 Ribbon Retractor 97
 Rib Cutter/Shearer 102
 Rigid Biopsy Forceps 225
 Rigid Endoscope Storage Tray 272
 Ring, Bull 349
 Ring, Cookie Nut 144
 Ring, Rectal 123
 Ringer, Jorvet Hog 363
 Ringer, Mop Bucket with 274
 Rings, Spare Rubber 371
 Roaring Burr (French) 352
 Rochester-Carmalt Forceps 82-83
 Rochester-Pean Forceps 83
 Rochester Forceps 82
 Rocker, Test Tube 316
 Rodent Anesthesia Machine 298
 Rodent Products 105, 337
 Rods 232, 237-238
 Roll, Combine 114
 Roll, Cotton 173
 Roll, Gauze Bandage 172
 Roll, Jorvet Cotton 173
 Roll-Around Caddy 224
 Rolled Gauze 172-173
 Rolls, ECG Paper 293
 Rongeurs 92-93, 263, 267
 Root Tip Pick 337
 Rope Toy 145
 Rosenthal Bone Biopsy Needle 68
 Rotor, 4 Place Centrifuge 322
 Rotor, Centrifuge w/ IRAP and Regular 323
 Round-Hole Plate 3.5mm Heavy-Duty 245
 Round Back Pet Combs 150
 Round Hole Plate 2.7mm 244
 Round Trocar 240
 Rubber, Reusable Black 303
 Rubber Block 360
 Rubber Caps 336
 Rubberized OB Products 188, 371
 Rubbermaid® Products 274
 Rubber Tube Cushion 316
 Rumen, Flux 348
 Rumen Collector Transfer Kit 348
 Rumen Magnets 349
 Ruskin-Liston Bone Cutting Forceps 91
 Ruskin Rongeur 92
 Russian Tissue Forcep 83
S
 S-Fluted Hand Rasp 341, 350
 Saafield Comedone Extractor 94
 Saf-T-Shield Collar 135
 Safe 'n Warm Exam Table Mat 134
 Safesite Injection Port 207
 Safety Cat Lead and Harness 142
 Safety Goggles 112
 Safety Labeled Wash Bottles 324
 Safety Pet Nail Clipper 156
 Safety Stick Syringe Pole 141
 Safil® Suture 47
 Safil Cassette Sutures 44
 Samson Digital Hand-held Scale 222
 Sam Splints 232
 Sandbags, X-ray 328
 Sands Castrator 106
 Sanitary Pooper Scooper 147
 Saw, Bone 101
 Saw, Modified Gigli Bone 99
 Saw Guide for TFO 254
 Scales 221-222, 292
 Scalers 341, 335
 Scalpels 74-75, 85, 127
 Schiøtz Tonometer 293
 Schimmer Tear Test 296
 Schoupe Wedge 360
 Schrader 304
 Scissors 86-90, 126, 156-157
 Scissors, Test 364
 Scooper, Sanitary Pooper 147
 Scope, Trinocular 286
 Scraper, Canine Tartar 341
 Scraper, Dental 341, 352
 Scrapers, Tartar 341
 Screw, 2mm Self-Tapping 244
 Screw, Cancellous 239, 249
 Screw, Cancellous 3mm 248
 Screw, Compression Plate and Cortical 246
 Screw, Jorvet Cortical Self-Tapping 253
 Screw, Locking Plug for TPLD Locking 253
 Screw, Self-Tapping 244
 Screw, TPLD 3.5mm Locking 253
 Screw-Driver, Hex 260
 Screw-On Prophyl Caps 336
 Screw/Anchor, Suture 253
 Screws, 2.4mm Cortical Self Tapping 247
 Screws, Jorvet 2.7mm Cortical Self Tapping 239
 Screws, Jorvet 3.5mm Cortical Self Tapping 239
 Screws, Sherman Self Tap 245
 Scriber, Bone 266
 Scrub, 99c Closeout 192, 193, 194, 197
 Scrubs, Angelstat® 182
 Scrubs, Med-Vet 183
 Seating, Classic Series Medical 218
 Self-Tapping Screw 239, 244
 Self-Tap Plating Case 252
 Semen Evaluation LabScope 286
 Senn-Mueller Retractor 97
 Senn Retractor 97
 Sensi-Touch® Surgical Gloves 175
 Serra Emasculator 358
 Serra Modified Emasculator 358
 Serrated Spay Scissors 89
 Serum Separation Tubes 316
 Set, Butterfly Infusion 203
 Set, Complete Infusion 204
 Set, IV Administration 202, 208
 Sevoflurane Vaporizer 299
 Shampoo 158
 Shark, Smoke 122, 227
 Sharp, Alm Retractor 96
 Sharp's Container 198
 Sharpening Steel 103
 Sharps Containers 198
 Shearer, Sheep Hand 349
 Shears, Foot-Rot Hoof 366

| | | | | | | | |
|--|------------------------|---|------------------------|---|----------|---|----------|
| Sheather's Sugar Flotation Solution | 326 | Soft Carry Stretcher | 213 | Stainless Steel Pails With Handle | 210 | Strap, Shedder Blade w/Leather | 151 |
| Shedder | 151 | Soft Tissue Biopsy Alligator Forceps | 106 | Stainless Steel Replacement Tray | 211 | Strap, Training Clicker with Wrist | 144 |
| Sheep/Goat Oral Drencher Kit | 62 | Soft Tissue Protection Sleeve | 256 | Stainless Steel Spike Washer | 263 | Strap Handle | 211 |
| Sheep Hand Shearer | 349 | Soft Tissue Protector | 336, 352 | Stainless Steel Surgical Blades | 74 | Strapping, Soft Padded Velcro | 234 |
| Sheet, Vet-lite | 235 | Solution, Microscope Lens Cleaning | 318, 326 | Stainless Steel Utility Cart | 220 | Strawberry Roaring Burr | 103 |
| Sheeting, Jorvet Cotton Bandage | 173 | Solution, Chlorhexidine | 128 | Stainless Steel Work Table | 220 | Stretcher, Animal | 213 |
| Sheets, Marq-Easy Thermoplastic Splint | 234 | Solution, Electrode Storage | 321 | Stallion Catheter | 369 | Stretcher, Soft Carry | 213 |
| Shelf, Storage | 298 | Solution, Lactated Ringers IV | 205 | Stand, Double Post Mayo | 211 | Strip Test, Reagent | 288 |
| Sherman Self-Tapping Plate System | 243 | Solution, Povidone Iodine | 115, 269 | Stand, Bowie Electrosurgical Unit | 215 | Stryker Saw adaptor - use w/multi blades | 259 |
| Sherman Self Tap Screws | 245 | Solution, Sheather's Sugar Flotation | 326 | Stand, IV | 202 | Stuff'n, Kong | 146 |
| Shield, Diamond Disc Safety | 352 | Solution, Sterilization | 273 | Stand, Mayo | 211 | Style Line Series Medical Seating | 218 |
| Shield | 112 | Solution, Trace Disclosing | 335 | Stand, Redden Navicular | 328 | Styilet, Corkscrew Trocar with Plastic | 240 |
| Shoecover | 112, 187 | Solution, Ultrasonic Cleaning | 271 | Standard "T" Extension Set | 206 | Styilet, Endotracheal Tube | 311 |
| Shoulder Length Gloves | 176 | Solution, Wavicide Sterilizing | 273 | Standard Microhematocrit Tube | 326 | Stylique Clipper | 154 |
| Shroud, Drill | 258 | Solution Bowl | 127, 212 | Standard Bore "T" Extension w/ Luerlock | 206 | Styptic Powder | 162 |
| Shurflow, Dr. Irvin's | 364 | Solutions, Hydrometer for Fecal Flotation | 326 | Standard Emasculator | 106, 358 | Subpalpebral Ocular Lavage Kit | 362 |
| Sidebar, Canine | 161 | Sontara Drape | 113, 114 | Standard TPLD Plate | 252 | Suction Canister, Tubing, Hose | 119 |
| Silicone Adhesive | 363 | Space-Saver IV Cage Mount | 208 | Stapler, Braun Manipler® AZ Suture | 49 | Sudan III Fecal Stain | 320 |
| Silicone Lubricant | 62 | Spatula, Jorvet Rodent Dental | 105 | Stapler, Oasis Skin 35R & 35W | 49 | Suit, Jorvet Rubberized OB | 188 |
| Silicon Endo Tube | 309 | Spatula, Rodent Dental | 337 | Stapler, Premium German Skin | 49 | Suit, Rubberized OB | 371 |
| Silicone Thoracic Drain | 134 | Spatula Tips | 336 | Staples, Cruciate | 254 | Suit, Rubberized OB Cover-All | 188 |
| Silicone Wound Drain | 133 | Spray Hook | 97 | Stationary IV Ceiling Hook | 208 | Sundry Jars | 124, 199 |
| Silicon Foley Catheter | 369 | Specimen Container | 200 | Stat Tracker | 321 | Super-Slim Block Resection Osteotome | 94 |
| Silk suture | 44-45 | Speculum | 96, 106, 281, 347, 360 | StaySafe - Self-Sealing Bottle Closures | 334 | Super Core Biopsy Needle | 68 |
| Silver Nitrate Applicator | 123 | Spencer Stitch Scissors | 89, 126 | Steam Autoclave Tape | 269 | Supercut Scissors | 89 |
| Silver Sulfadiazine Cream | 180 | Sphygmomanometer, Doppler | 289 | Steam Indicator Strips | 269 | Super Pocket Pro Clipper | 154 |
| Sites, IV Extension Set w/two Y | 202 | Spike, Hemo Tap Filter | 296 | Steel, Sharpening | 103 | Super Soft Blue Ultrasonic Insert | 335 |
| Skin Retractor | 97 | Spinal Needles | 370 | Steel, Stainless | 243 | Supply Cabinet | 218 |
| Skin Stapler 35R, 35W & Remover | 49 | Spinlock, Reduction Forceps with | 102, 265 | Steel Stainless K-Wire | 100 | Support, Jorvet Rabbit/Rodent Dental Head | 337 |
| Skin Staple Removing Forceps | 83 | Splice Plate for IV Track | 208 | Steinman Pin | 240 | Support, Ultra Stand X-ray Machine | 328 |
| Skunk-Off | 276 | Splints | 205, 233, 353 | Sterile, Lap Sponge | 172 | Supra Condylar Osteotomy Plates (SCOP) | 251 |
| Sleeve, Soft Tissue Protection | 256 | Splinter Forceps | 83 | Sterile Culture Tubes | 334 | Surgeon Cap | 112, 187 |
| Sleeve, Total OB | 188, 371 | Splint Rod Bender with Splint Rods | 232 | Sterile Disposable Specimen Container | 200 | Surgeon Gloves | 175 |
| Slickerbrush® | 151 | Splitter, Nail | 91 | Sterile Disposable Surgery Gown | 110 | Surgery/Exam Table | 220 |
| Slides & Covers, Microscope | 319 | Splitter, Pill | 334 | Sterile Gauze | 171 | Surgery Cap with Ties | 112 |
| Stocum/TPLD Rotation Gauge | 103, 254 | Splitter, Tendon | 365 | Sterile OB Lube-Vet Label | 133 | Surgery Mask | 112 |
| Small Animal Basic Prophy Kit | 338 | Sponge Bowl | 107, 127, 212 | Sterile Stretch Gauze Rolls | 172 | Surgery Sterilization Pack Wraps | 269 |
| Small Animal Blood Collection Set | 205 | Sponge Forceps | 83 | Sterile Surgeon Gown | 110, 186 | Surgery Table | 220 |
| Small Animal Cryo Kit | 217 | Sponges, Gauze | 171 | Sterile Surgical Drape | 113-114 | Surgery Towel | 114 |
| Small Animal Electric Tattoo Kit | 367 | Sponges, Jorvet Laparotomy | 172 | Sterile Surgical Scrub Brush | 116 | Surgi-Close Staple, Remover, Reloads | 49 |
| Small Animal Rainbow Prophy Kit | 338 | Sponges, Non-Woven Gauze | 171 | Sterile Swann-Morton Scalpel Blades | 276 | Surgical Enzyme Cleaner | 270 |
| Small Bone Extension Set w/Ultralite | 206 | Spoon, Fecal Specimen Container with | 200 | Sterile Veterinary Surgical Drapes | 113 | Surgical Head Lamp | 120 |
| Small Bore "T"-Port | 206 | Sportswraps Light | 235 | Sterile X-ray Cassette Cover | 327 | Surgical Instrument Guards | 108, 256 |
| Small Emasculator | 106, 358 | Spout, Pour | 299 | Sterilization Products | 269-275 | Surgical Masks | 112 |
| Smaller, Jorvet K-wire/Small Pin Punch | 99 | Sprague-Rappaport Stethoscope | 277 | Sterilizer Forceps | 83 | Surgical Pack Wrapper | 113 |
| Small Extracting Forceps Kit | 343 | Spray, Bitter Rid | 159 | Sterilizing Tray | 272 | Surgical Procedure Mask w/ Ear Loops | 112 |
| Small Fixation Type I Kit | 237 | Spray, Chlorhexidine and Zinc Oral | 159 | Stethoscopes | 277-279 | Surgical Scrub Applicator | 116 |
| Small Fragment Forceps | 265 | Spray, Clean and Fresh Oral | 159 | Stevens Tenotomy Scissors | 89 | Surgical Skin Marker w/Ruler | 118 |
| Small Jacobs Chuck | 105, 258 | Spray, Cut-Heal Wound | 161 | Stick, Dental | 146 | Surgical Tie-Downs | 116 |
| Small Linear Fixator Kit | 239 | Spray, Groom-Aid | 157 | Sticks, Applicator | 124 | Surgiclose Skin Stapler | 49 |
| Small Loop Abscess Knife | 104, 359 | Spray Bottle | 198 | Stifle Distractor w/Spinlock | 98, 264 | Surgivet, Pulse Oximeter Sensor | 287 |
| Small Lowman Bone Clamp | 103 | Spray Lube | 109 | Stifle | 97 | Suture | 43-50 |
| Small Narcotics Cabinet | 219 | Spreader, Beeson Cast | 259 | Stifle Positioner | 116 | Suture, OCL Lateral | 261 |
| Small Pin/Tap Chuck | 105, 256 | Spreader | 101-102, 257 | Stifle Retractor | 98, 264 | Suture, DA Toggle | 367 |
| Small Pin Vise | 100 | Spring Infusor | 207 | Stille-Luer Rongeur | 267 | Suture, Ethilon® | 45 |
| Small Soaking Tray | 272 | Squeaker, Plush Vegetable Toy with | 143 | Stille Liston Bone Cutting Forceps | 268 | Suture, LigaFiba Lateral | 48, 262 |
| Small Stifle Retractor | 264 | Squeezees, Floor | 273 | Stitch Scissors | 89 | Suture Kit | 367 |
| Snock, Rubberized OB | 188, 371 | Stain, Acid Fast, Dip Quick, Semen | 320 | Stockinette | 230 | Suture Needles | 75 |
| Smoke Shark | 122 | Stainless Steel | 341 | Stomach Tube | 130 | Suture Removal Kit | 50 |
| SMS, Disposable Surgical Drape | 114 | Stainless Steel | 243 | Stomach | 218 | Suture Screw/Anchor | 253 |
| Snare | 100-103, 141, 354, 367 | Stainless Steel Bowls | 148 | Stopcock 3-Way | 202 | Suture Wire | 50 |
| Snarem Restraint | 141 | Stainless Steel Brush | 270 | Storage Shelf | 298 | Swabs, Agar Gel Transport | 324-325 |
| Snook Retractor | 97 | Stainless Steel Case for TTA Equipment | 257 | Strabismus Scissors | 89 | Swann-Morton | 127 |
| Snugglesafe Heat Pad | 128 | Stainless Steel case w/Screw Rack | 264 | Straight-Sided Pail | 210 | Swann-Morton Disposable Scalpel | 75 |
| Socks, BUSTER Dog | 166 | Stainless Steel Embossed Treat Canister | 167 | Straight and Curved Feeding Needle | 66 | Swedish OB Wire Handle | 100 |
| Soda Lime | 299 | Stainless Steel Hypodermic Needle | 67 | Strap, DogLegs Chest | 236 | Swine Extra-Long 8mm Silicon | 310 |
| Soft-E-CollarT | 138 | Stainless Steel Kick Bucket | 210 | Strap, Jorvet Bovine Hobbie | 354 | Swing Arm Centrifuge 8-3K | 323 |
| Soft-Tissue Biopsy Needle | 68 | Stainless Steel Pails | 210 | Strap, OB Calving | 101 | Swiss Knife | 104, 126 |

- Swiss Tweezer Forceps 83
 Swivel Connector 311
 Syringes 54-64, 355-356
 Syringe, Jorvet Nano Paste 107
- T**
- *T-Plate 251
 *T-Port, Small Bore 206
 T-Bar Swine Snare 103
 T-Connector, IV 202
 T-Handle Blade Punch 351
 T-Port, IV Extension w/Needleless Valve & 206
 T-Port Small Bore Extension Set 202
 Table, Exam, Wet & Grooming 157, 220-221
 Table Top Anesthesia Unit 298
 Tabletop Centrifuge 322
 Table Topper 220
 Tail Docker 103
 Tail Splint 233
 Talking Bone Toy 145
 Tank, Portable Water 336
 Tape, 3M Fiberglass Casting 230
 Tape, Co-Flex®, Coban®, Elastic 178-179
 Tape, Instrument ID Roll 107
 Tape, Jorvet Surgical Adhesive 179
 Tape, Umbilical 50, 103
 Tape, Micropore® 179
 Tape, Oasis Cohesive, Porous 178-179
 Tape, Orthopedic Casting 230
 Tape, Perivaginal 133
 Tape, Petflex® 178
 Tape, Porous 179
 Tape, PowerFlex® 178
 Tape, Steam Autoclave 269
 Tape, Transpore® 179
 Tape, X-Ray Label 329
 Tape, Zonas® Porous 179
 Tartar Scrapers 341
 Tattoo Digits & Pliers 367
 Tattoo Digits & Numbers 141
 Tattoo Paste 141
 Taylor Hammer 103, 126
 Test Instruments 364
 Tech III Isoflurane Vaporizer 250cc 298
 Technovit (for external fixation use) 255
 Technovit 255, 362
 Tech Vaporizer 298
 Tech V Isoflurane 299
 Teletest ECG Electrodes 293
 Tender Touch Slicker Wire Brush 151
 Tendon Splitter 365
 Tenotome 107, 365
 Tensioning Clamp 262
 Terminator Nail Trimmer 156
 Terry Bear Urns 169
 Terry Towel 156
 Terumo, Syringe & Needle 58
 Test, Idexx, Antigen, etc 296
 Tester, Hoof 366
 Test Tube, Rack, Rocker 316
 The Cardio Link 128
 The Lone Star Veterinary Retractor System 347
 TheraPaw Protector 162
 Thermo-Kool 300
 Thermal Cautery Unit 120
 Thermal Jacket 226
 Thermal Reflective Blanket 127
 Thermistor 287
 Thermoblocker Recovery Bag 299
 Thermometer 124, 297
 Thermo Perch 144
 Thermo Pet Mat 160
 Thermoplastic Splint Sheets Kit 234
 The Walkabout™ Harness 164
 Thomsen's Universal Dental Float 346, 351
 Thoracic Positioner 116
 Thoroughbred Speculum 347
 Threaded, Fully 249
 Threaded External 238
 Three Root Extracting Forceps 343
 Thumb Dressing Forceps 84
 Thumb Speculum 347
 Thumb Tissue Forceps 84
 Thygesen Fetatome with Coil 370
 Tibial Wedge Osteotomy Plate 252
 Tie-Downs, Surgical 116
 Tiegland Modified Culture Swab 324
 Ties, Surgery Cap with 112
 Tightener, Double Loop Cerclage Wire 98, 263
 Tip, Jorvet Digital Thermometer Flexible 297
 Tips, Pipette 317
 Tips, Spatula 336
 Tissue, Facial 115
 Tissue/Cuticle Nipper 91
 Tissue Adhesive 50
 Tissue Forceps 83, 84
 Toggle, Bone 266
 Toggle Insertion Kit 266
 Tom Cat Catheter 117
 Tomcat Positioner 116
 Tonometer, Schlotz 293
 TonoVet 287
 Tool, Primary Check Removal 312
 Tooth, Deciduous Incisor 350
 Tooth Cutter 342, 352
 Toothpaste, PetDental 159
 Tooth Punch-Straight 342
 Topper, Table 220
 Tops, Sundry Jars Clear 199
 Total OB Sleeve 188, 371
 Touchtm, Easy 60
 Touch Up Trimer Kit 154
 Tourniquet 125
 Towel, Multi-Fold 125, 224
 Towel, Professional 125
 Towel, Surgery 114
 Towel, Terry 156
 Towel Drape Plain ACT Material 113
 Towel Drape Sontara 113
 Towellettes 274
 Towels, New Operating 114
 Tower, Interactive Cat 143
 Tower, Perch 143
 Towlette, Cleansing 274
 Toys 145
 Trace Disclosing Solution 335
 Tracheal Wash Kit 363
 Tracheotomy Tube 299
 Trainer, No-Pull 142
 Training Clicker with Wrist Strap 144
 Transfer Bag 204
 Transfer Needle 70
 Transformer, Welch Allyn 3.5v Wall 283
 Transfusion and Infusion Set 204
 Transilluminator 283
 Transpore® Tape 179
 Trap, Hair 157, 221
 Trapper Handling Gloves 177
 Trap Transfer Restrainer 141
 Tray 109, 123, 211, 272, 342
 Treatment Cabinet 218
 Trephine, Equine Sinus 345, 359
 Trephine, Horasley's 345
 Trephine, Michele 297
 Trephine Head Only 359
 Trephine Set 345, 359
 Triangle Electrode 121, 215
 Trimmer, Bird Nail & Feather 144
 Trimmers 90, 144, 156, 366
 Trinocular Microscope & Parts 286
 Triple Beam Pan Balance 222
 Triple Osteotomy Plate 254
 Trocar, Bull's Corkscrew 266
 Trocars 240
 Trochlear Rasp 94
 True Cut Style Biopsy Needle 68, 370
 Tub, Walk-In Stainless Steel 157, 221
 Tube, Anesthesia Breathing 302
 Tube, Centrifuge 290, 323
 Tube, Crimp 259
 Tube, Cuffed Endotracheal 308
 Tube, Disposable Polystyrene 288
 Tube, Dr. Larsen's Im Test 364
 Tube, Endotracheal 308, 309, 310
 Tube, Equine Endotracheal 363
 Tube, Equine Silicon Endotracheal 310
 Tube, Equine Silicon Tracheostomy 363
 Tube, Esophagostomy 315
 Tube, Feeding 130
 Tube, Foal Nasotracheal 363
 Tube, IM Bone Pin Protective 240
 Tube, Medical Grade Silicone Elastomer 130
 Tube, Silicon Chest Drainage 131
 Tube, Silicon Endo 309
 Tube, Standard 75mm Microhematocrit 326
 Tube, Stomach 130
 Tube, Test 316
 Tube, Tracheotomy 299
 Tube, X-Long Test 365
 Tube Dehomer 349
 Tube Gauze 122
 Tubes, Endotracheal 308
 Tubes, Feeding/Stomach 129
 Tubes, Mason Line Crimp 261
 Tubes, Microhematocrit Capillary 289, 326
 Tubes, Milk 371
 Tubes, Serum Separation 316
 Tubes, Sterile Culture 334
 Tubes, Universal Cap for Test 316
 Tubing, IV Latex Surgical 208
 Tubing, Jorvet Oxygen Supply 313
 Tubing, Jorvet Sterilization 269
 Tubing, Penrose 116
 Tubing, Sterilization 269
 Tubing, Suction 119
 Tumbler 127, 212
 Tunnel, Radiograph Cassette 328
 Turret, Binocular Microscope with Phase 285
 Turret, Binocular Scope w/Phase 285
 Turret, Trinocular LabScope 286
 Twin-Point Fragment Forceps 91, 265
 Twir'em Pack 317
 Twister, Wire 100
 Twitch 342, 347, 360, 362
- U**
- U.S. Army Pattern Chisel 93
 U.S. Army Retractor 98
 U40 Insulin Syringe 59
 Udder Infusion Cannula 364
 Ultracare Veterinary U40 Insulin Syringe 59
 Ultimate Laboratory Microscope 284
 Ultimate Touch Professional Mat Removing Comb 151
 Ultimate Touch Shed 'N Blade 151
 Ultra 8 Centrifuge 322
 Ultrascope Stethoscope 279
 Ultrascope Stethoscope Parts 279
 Ultra Select Centrifuge 322
 Ultrasite IV Adapter 207
 Ultrasonic Cleaner 275
 Ultrasonic Cleaning Solution 271
 Ultrasonic Insert 336
 Ultrasonic Scaler 335
 Ultrasound, Intellect® Transport 290
 Ultrasound Gel 290
 Ultrasound gel 290
 Ultra Stand X-ray Machine Support 328
 Ultraviolet Light 291
 Ultraviolet Wood's Light 291
 Umbilical Huston Hernia Clamp 103
 Umbilical Tape 103
 Undercoat Rake 153
 Underpads 123, 149
 Universal Bottle Adapter 334
 Universal Cap for Test Tubes 316
 Universal Centrifuge 322
 Universal Cube Test Tube Rack 323
 Universal Lister Scissors 90
 Unna's Boot 181
 Urethral, Feline 117
 Urethral Catheter 117
 Urine Collection Bag 134
 Urine Drainage Bag 134
 Urine Reagent 5 288
 Urns 168-170
 Uro-Collect System 134
 Uterine Biopsy Forcep 106
 Uterine Cytology Brush 324
 Uterus Pump 131
 Utility Bandage Scissors 90, 126
 Utility Cart 220
 Utrecht Fetatome with Coil 370
- V**
- Vacuum Lamp 282
 Vaginal Speculum 295
 Vaginoscopes 295
 Valve, Flush 312
 Valve, GasVak™ Balancing 216
 Valve, Mask One Way 302
 Valve, Oxygen Booster 90PSI with Relief 301
 Valve, Pop-off 298
 Valve, Wall Mount Balancing 216
 Vaporizers 298-301
 Vasectomy Ring Clamp (No Scalpel) 85
 Vaxi-Drench 15 Injector/Drenche 65, 357
 Vectra® Geniys Laser System 228
 Verbrugge Forceps 84
 Veruca-Freeze Starter Kit 122
 Vet-10 Urine Reagent Strips 288
 Vet-Alarm Respiratory Monitor 295
 Vet-BUN Reagent Strips 288

| | | | |
|---|----------------|--|----------|
| Vet-lite Cast Material | 235 | Wet Table | 221 |
| Vet-lite Sheet | 235 | White's Modified Emasculator | 106, 358 |
| Vet-R-Som Gloves | 176 | White's Toenail Scissors | 90, 157 |
| Vet-Syringe & Terumo | 58 | Wick, AbsorbENT™ Ear | 128 |
| Vetomatic Syringe & Parts | 64-65, 356-357 | Winged Infusion Set | 203 |
| Veterinary Anatomical Charts | 332 | Winged IV Infusion Set | 204, 370 |
| Veterinary Biosecurity Protective Apparel Kit | 123 | Wipes, AOE Deodorizing | 276 |
| Veterinary Pulse Oximeter | 287 | Wipes, Cavicide | 273 |
| Veterinary Pulse Oximeter with Thermistor | 287 | Wipes, Dentacetic | 160 |
| Veterinary Scale (F) | 292 | Wipes, Disinfecting | 273 |
| Veterinary Surgical Drape | 113 | Wipes, Malacetic Wet | 158 |
| Veterinary Virology Sampling Kit | 321 | Wipes®, Push Up Box for Kim | 226 |
| VetMed Care Protective Bodysuit | 163 | Wire, Gigli, Hauptner OB, etc | 98-100 |
| Vet Tech Kit | 293 | Wire, Suture | 50 |
| Vials, Amber Prescription Safety Cap | 198 | Wire Cutting Scissors | 90 |
| Vicryl® Suture | 46 | Witness FeLV Test Kit | 296 |
| Video Otoscope | 225 | Witness Heartworm Antigen Test | 296 |
| Vienna Double OB Hook | 365 | Witness Parvo Test | 296 |
| Vin-Silverman Biopsy Needle | 68 | Wolf Tooth Elevator | 352 |
| Vinyl Dog Toy | 145 | Wolftooth Elevator | 359 |
| Vinyl Gloves | 174 | Wolftooth Elevator Set | 359 |
| Violet, Monocyn | 47 | Wolftooth Extractor Forcep | 343, 359 |
| Viscera Retainer | 365 | Wolftooth Extractor Set | 343, 359 |
| Viscosity, Bone Cement | 255 | Wooden Bone-Shaped Leash Holder | 165 |
| Vise, Jorvet Small Pin | 268 | Wood Pet Rakom | 153 |
| Vise, Small Pin | 100 | Woods Light | 291 |
| Visor Head Light | 290 | Wrap, Cloth Instrument | 115 |
| Visor Light Replacement Bulb | 290 | Wrap, CSR | 115 |
| Vital Signs Monitor | 213 | Wrap, Jorvet Equine Leg | 181, 362 |
| Volkman Bone Curette | 95, 267 | Wrap, Parson's Equine | 368 |
| Vulva Suture Pin | 109 | Wrap, Equine "Army Surplus" Brown Leg | 361 |
| W | | Wrapper, Surgical Pack | 113 |
| Walk-In Stainless Steel Tub | 157, 221 | Wraps, Surgery Sterilization Pack | 269 |
| Walk-On Scale | 222 | Wrench | 239 |
| Walka Boo | 160 | Wubba Wubba | 143 |
| Wall Mount Anesthesia | 298 | Wye-Connector | 312 |
| Wall Mount Anesthesia Units | 298 | Wye Adapters | 305 |
| Wall Mount Balancing Valve | 216 | X | |
| Wall Mount Dial Flow Meter | 307 | X-Ray Aprons | 329 |
| Warden Handling Gloves | 177 | X-Ray Cassette | 329 |
| Warden Pro Handling Gloves | 177 | X-Ray Density Filter | 329 |
| Warmer, Jorvet IV Fluid | 209 | X-Ray Developing Hanger | 329 |
| Warming Airbag | 128 | X-Ray Gloves | 329 |
| Wash®, Oster Blade | 155 | X-Ray Illuminator | 327 |
| Washer, Bone | 264 | X-Ray Illuminator Bulb | 327 |
| Washer, Stainless Steel Spike | 263 | X-Ray Label Tape | 329 |
| Water Bottle w/ lid and Tubing for Endoscope | 227 | X-ray Measuring Caliper | 329 |
| WaveBrake®, Rubbermaid | 274 | X-Ray Mittens | 329 |
| Wavicide Sterilizing Solution | 273 | X-Ray Sandbags | 328 |
| Wax, Bone | 50, 264 | X-Ray Thyroid Collar | 329 |
| Web Master Harness | 160 | X-Ray Thyroid Cover | 329 |
| Webster Needle Holder | 77 | Xerofom Petroleum Gauze | 173, 180 |
| Wedge, Bayer Mouth | 360 | Y | |
| Wedge, Dental | 337 | Y-Connector for Heating Mat | 226 |
| Wedge, Equivet Mouth | 360 | Yankauer Handle | 119 |
| Wedge, Equivet Pony Size Mouth | 360 | Y Barb Connector | 131 |
| Wedge, Meier Dental | 360 | Yoke, Oxygen Hookups Regulators & Mounting | 306 |
| Wedge, Osteotomy | 254 | Yorker Dropper Bottle | 200 |
| Wedge, Schoupe | 360 | Young Tongue Seizing Forceps | 84 |
| Wedge Angle Finder Overlay | 254 | Yuk-Ze Anti-Lick Gel | 159 |
| Wedge Osteotomy Gauge Set | 254 | Z | |
| Wee-Wee Housebreaking Aid | 147 | Ziggies | 146 |
| Wee-Wee Pads | 167 | Zinc Sulfate Fecal Flotation Medium | 288, 326 |
| Weingart's Mouth Speculum | 360 | Zonas® Porous Tape | 179 |
| Weilauer Retractor | 98 | ZoomGroom, Kong | 165 |
| Welbourn Cat Catche | 140 | | |
| Welch Allyn Products | 281-283 | | |
| Westcott Tenotomy Scissors | 90 | | |



MED-VET INTERNATIONAL
 13822 W Boulton Blvd
 Mettawa, IL 60045
WWW.SHOPMEDVET.COM

Monoject **BLOWOUT**

A LIMITED SUPPLY FOR A LIMITED TIME! SEE OUR SYRINGE AND NEEDLES SECTION!

- BUY 1 GET 1 FREE SPECIALS!
- CLOSEOUTS @ DEEP DISCOUNTS!
- LOYAL CUSTOMERS SPECIALS!

CONNECT WITH US @:

facebook .com/medvetinternational

@SHOPMEDVET



FREE

GIFTS WITH YOUR NEXT QUALIFYING PURCHASE

FREE AMEX GIFT CARD

with required purchase, certain restrictions apply.



FREE SAVINGS BONDS

with required purchase, certain restrictions apply.



FREE DIGITAL CAMERA

with required purchase, certain restrictions apply.



Your choice of one with qualifying purchase. See page 1 for details

NEW AND EXPANDED ORTHOPEDIC SECTION

EXPANDED COMPREHENSIVE LISTINGS OF PRODUCTS
 MORE PINS, MORE PLATES,
 MORE OF EVERYTHING!



NEW LARGE ANIMAL SECTION!

WITH ALL NEW PRODUCTS
 SPECIALIZING IN
 BOVINE, EQUINE & SWINE



CHECK OUT OUR EXPANDED DENTAL AND INSTRUMENT SECTIONS FOR HUNDREDS OF NEW INSTRUMENTS ADDED!